





Cardiovascular

Scissors	328 -
356	Needle Holders
.....	357 - 370 Forceps
.....	371 - 377
Titanium Forceps and Clamps	378 -
389	Forceps and Clamps
.....	390 - 399 Vascular Clamps
.....	400 - 481 Bulldog and
Micro Vessel Clamps	482 - 490 Vessel
Instruments	491 - 493
Specialty CV/Thoracic Instruments and Retractors ..	494 -
507	Retractors
.....	508 - 517 Rib
Spreaders	518 - 533

Cardiovascular

Scissors



Vessel Scissors

Catalog Number	Tip	Blade	Length (in.)
BC034R	B/B	1-PROBE-PT	5 3/4



MAYO Operating Scissors

Catalog Number	Tip	Blade	Length (in.)
BC466	S/	STR	5 1/2
R	S	CVD	5 1/2
BC467	S/		
R	S		

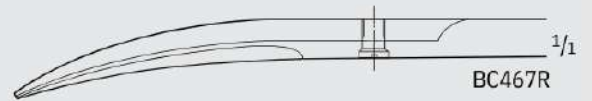

MAYO SuperCut Scissors, Delicate

Catalog Number	Tip	Blade	Length (in.)
BC924	B/	STR	6 1/2
R	B	CVD	6 1/2
BC925	B/		
R	B		





CHURCH Scissors, Beveled

Catalog Number	Tip	Blade	Length (in.)
MB618	B/	STR	7
R	B	CVD	7
MB619	B/		
R	B		

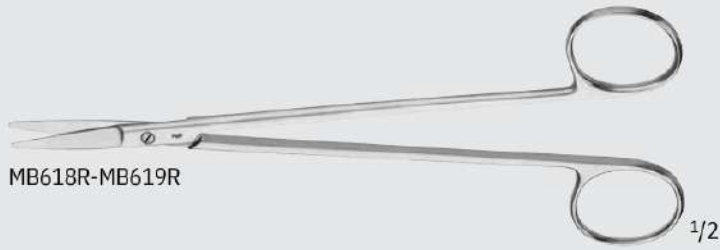

MB618R-MB619R



MB618R



MB619R

DEBAKEY Arteriotomy Scissors

Catalog Number	Tip	Blade	Length (in.)
BC629R	B/B	CVD	6 7/8

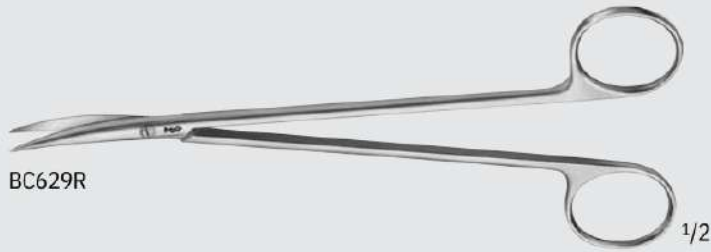

BC629R



BC629R

THOREK Scissors

Catalog Number	Tip	Blade	Length (in.)
BC636R	B/B	HEAVY-CVD	7

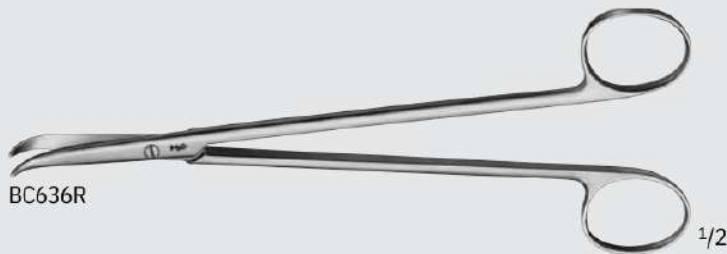

BC636R

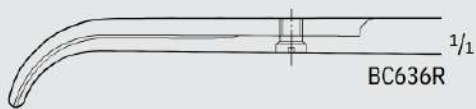

BC636R

SCHMIEDEN-TAYLOR Dura Scissors

Catalog Number	Tip	Blade	Length (in.)
BC660R	1 BALL-PT	ANG	6 1/8

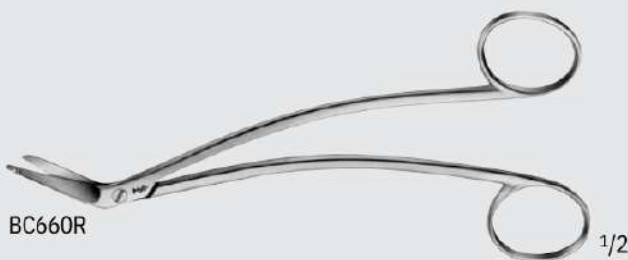

BC660R



BC660R

Cardiovascular

Scissors



SATINSKY Vena Cava Scissors

Catalog Number	Blade	Length (in.)
BC641R	CVD	9 5/8

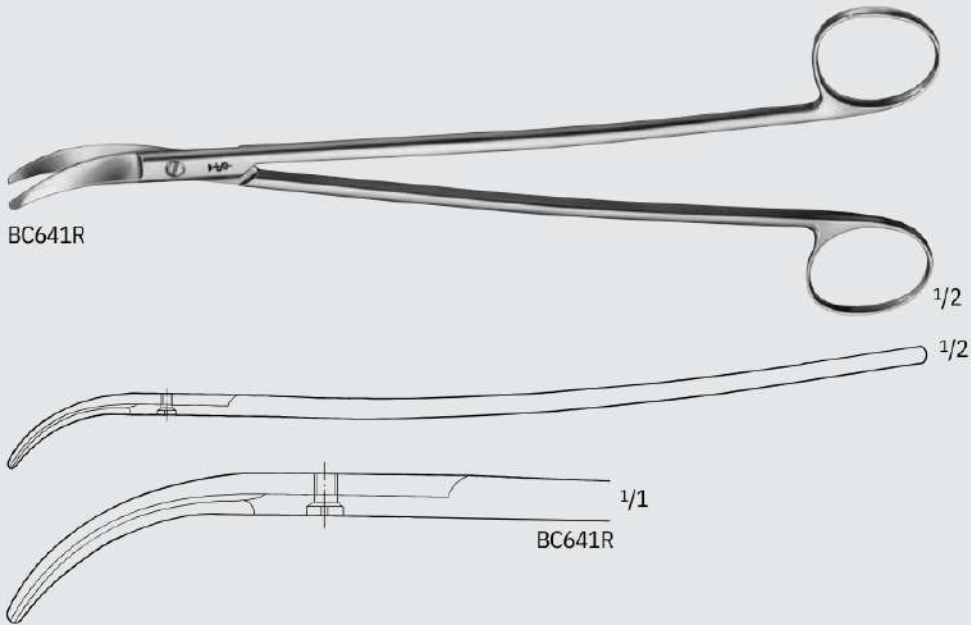

STRULLY Scissors

Catalog Number	Tip	Blade	Length (in.)
BC644R	S/S	CVD	8 3/4

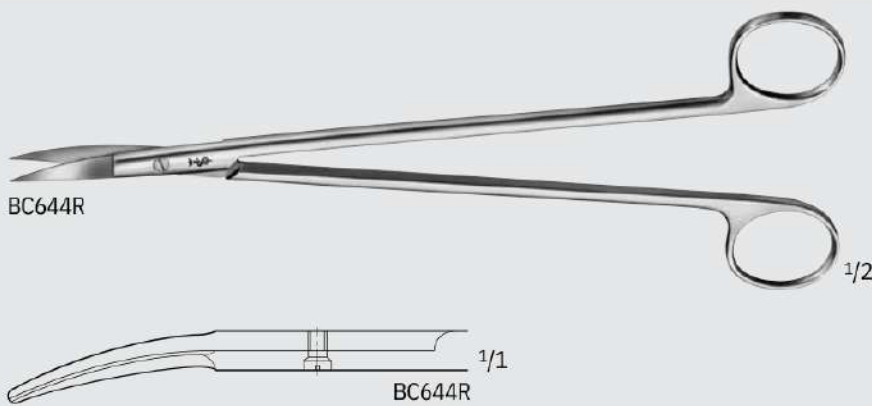

STRULLY Scissors

Catalog Number	Tip	Blade	Length (in.)
BC645R	PROBE	CVD	8 3/4

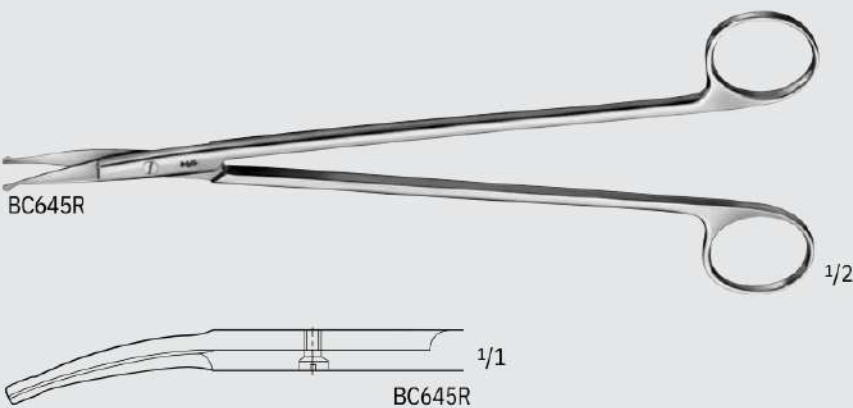



POTTS-SMITH Dissecting Scissors

Catalog Number	Tip	Blade	Length (in.)
MG381R	B/	CVD	5 1/2
BC643R	B	CVD	7 1/2
BC191R	B/	CVD	9
US145	B	CVD	11 1/4



BC191R, BC643R, MG381R, US145

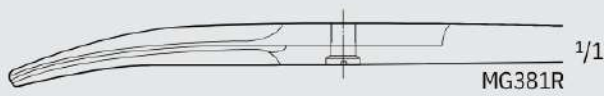

MG381R

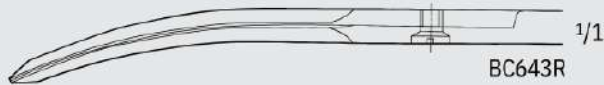

BC643R



BC191R



US145

MORSE Scissors

Catalog Number	Tip	Blade	Length (in.)
BC196R	S/S	CVD	6 7/8



BC196R



BC196R

HOHENFELLNER Scissors

Catalog Number	Tip	Blade	Length (in.)
BC638	B/	CV	8 7/8
R	B	D	10
BC639	B/	CV	
R	B	D	



BC638R-BC639R

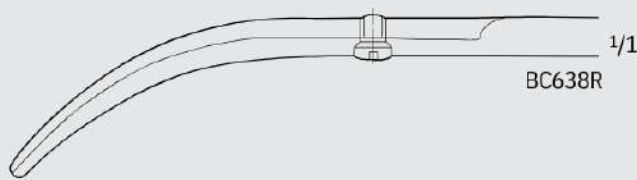

BC638R

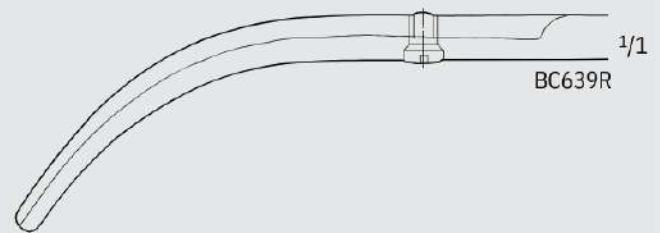

BC639R

Cardiovascular

Scissors



JAMESON-METZENBAUM Scissors

Catalog Number	Tip	Blade	Length (in.)
MG383R	S/S	CVD	9

MG383R 1/2

MG383R 1/1

LILLEHEI-POTTS Tenotomy Scissors

Catalog Number	Tip	Blade	Length (in.)
MG382R	S/S	CVD	7

MG382R 1/2

MG382R 1/1

JAMESON Tenotomy Scissors, Delicate

Catalog Number	Tip	Blade	Length (in.)
BC177R	B/B	CVD	6

BC177R 1/2

BC177R 1/1



POTTS Tenotomy Scissors

Catalog Number	Tip	Blade	Length (in.)
BC178	B/	CV	6 7/8
R	B	D	8
BC179	B/	CV	
R	B	D	

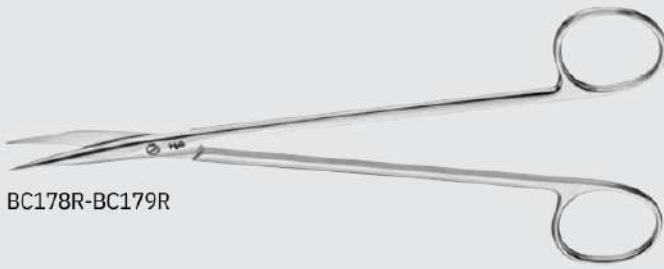

BC178R-BC179R



BC178R

1/1



BC179R

1/1

JAMESON SuperCut Scissors, Delicate

Catalog Number	Tip	Blade	Length (in.)
BC911R	B/	CV	5 1/8
BC915R	B	D	6
BC919R	B/	CV	7
	B	D	
	B/	CV	
	B	D	



BC911R, BC915R, BC919R

1/2



BC911R

1/1



BC915R

1/1



BC919R

1/1

Cardiovascular

Delicate Scissors



VASCULAR

METZENBAUM SuperCut Scissors

Catalog Number	Tip	Blade	Length (in.)
BC936	B/	STR	7
R	B	CVD	7
BC937	B/		
R	B		

BC936R-BC937R

1/2

BC936R 1/1

BC937R 1/1

METZENBAUM SuperCut Scissors

Catalog Number	Tip	Blade	Length (in.)
BC945	B/	CV	9
R	B	D	10 1/4
BC947	B/	CV	11 1/4
R	B	D	11 3/4
BC949	B/	CV	14
R	B	D	
BC951	B/	CV	
R	B	D	
BC953	B/	CV	
R 1/1	B	D	

BC945R-BC953R

BC945R

BC947R 1/1

BC949R 1/1

BC951R 1/1

BC953R 1/1



GORNEY Scissors

Catalog Number	Tip	Blade	Length (in.)
BC188	B/	STR	7 3/4
R	B	SLIGHT-CVD	7 3/4
BC189	B/		
R	B		



BC188R-BC189R

1/2



BC188R

1/1

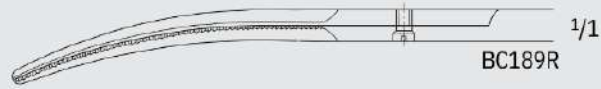

BC189R

1/1

COOLEY Cardiovascular Scissors

Catalog Number	Tip	Blade	Length (in.)
BC597	B/	CV	7 1/2
R	B	D	9
BC599	B/	CV	
R	B	D	



BC597R-BC599R



BC597R-BC599R

1/1

POTTS-SMITH Lateral Angle Scissors

Catalog Number	Tip	Blade Angle	Blade Length (mm)	Length (in.)
BC646R	S/S	55°	19	7



BC646R

1/2

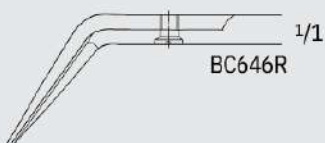

BC646R

1/1

Cardiovascular

Delicate Scissors



BC655R



BC655R

POTTS-SMITH Reverse Scissors

Catalog Number	Tip	Blade Angle	Handle	Length (in.)
BC655R	S/S	130°	W/ STABILIZING BAR	7

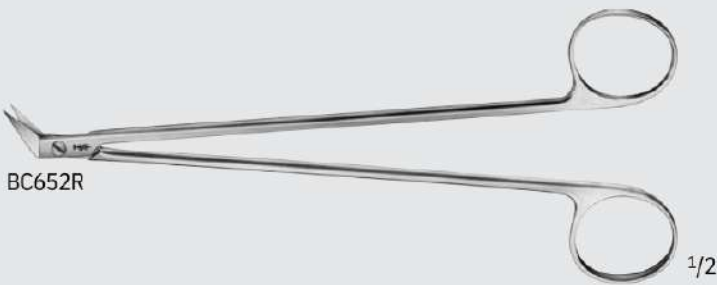

BC652R

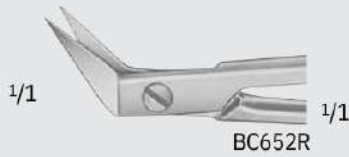

BC652R

POTTS-SMITH Vessel Scissors

Catalog Number	Tip	Blade Angle	Blade Length (mm)	Length (in.)
BC652R	S/S	60°	10	6 7/8

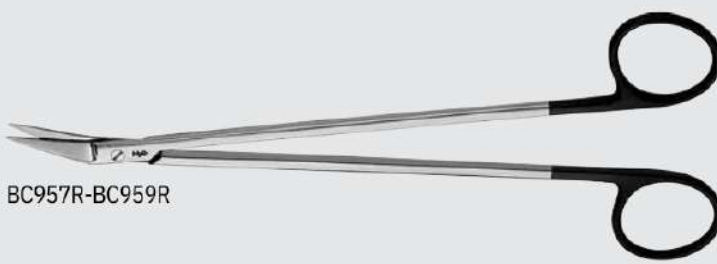

BC957R-BC959R



BC957R



BC958R



BC959R

POTTS-SMITH SuperCut Scissors

Catalog Number	Tip	Blade Angle	Blade Length (mm)	Length (in.)
BC957R	B/B	25	2	7 1/2
BC958R	B/B	°	2	7 1/4
BC959R	B/B	45	2	7
		°	0	
		60	1	
		°	9	



POTTS-DE MARTEL Scissors

Catalog Number	Tip	Blade Angle	Blade Length (mm)	Length (in.)
BC647R	S/S	30	2	7 1/4
BC648R	S/S	°	1	7 1/4
BC649R	S/S	45	2	7 1/4
BC650R	S/S	°	1	8 3/4

60	2
°	1
60	2
°	1

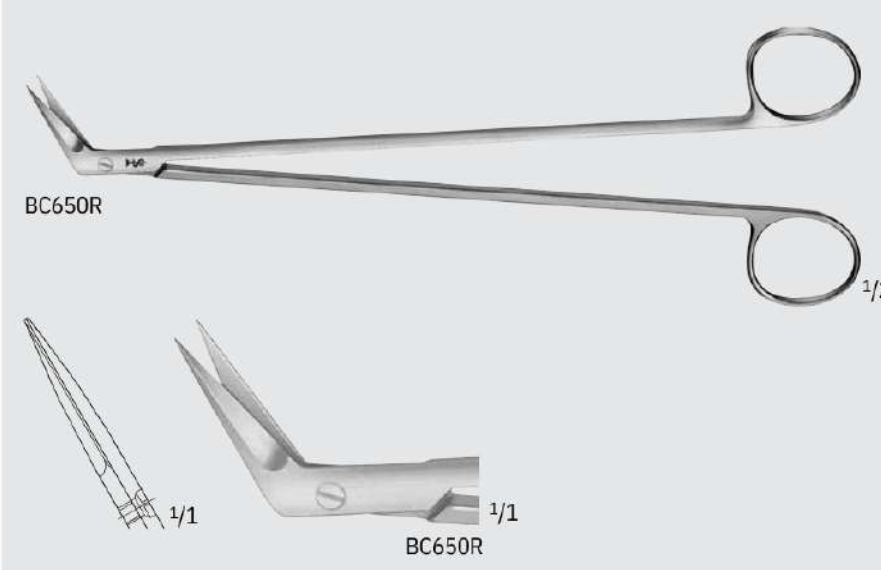
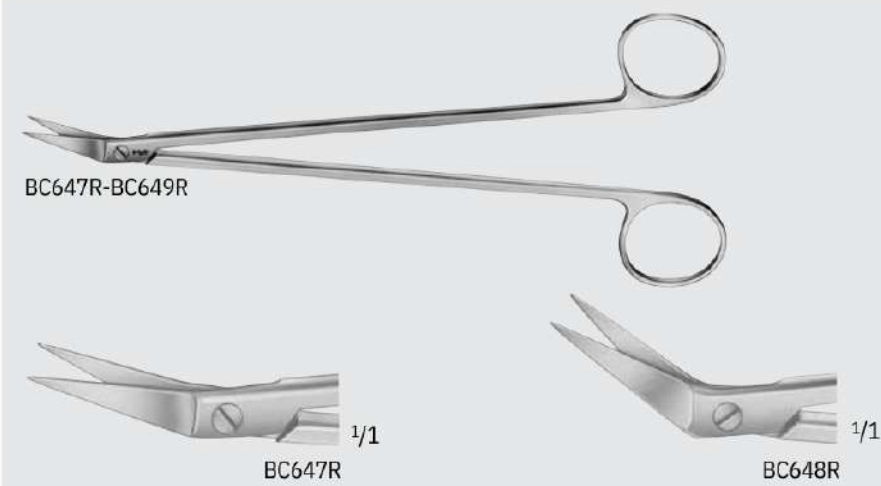

MILLS Scissors

Catalog Number	Tip	Blade	Blade Length (mm)	Length (in.)
BC651R	BALL-POINT	60°	23	8 3/4

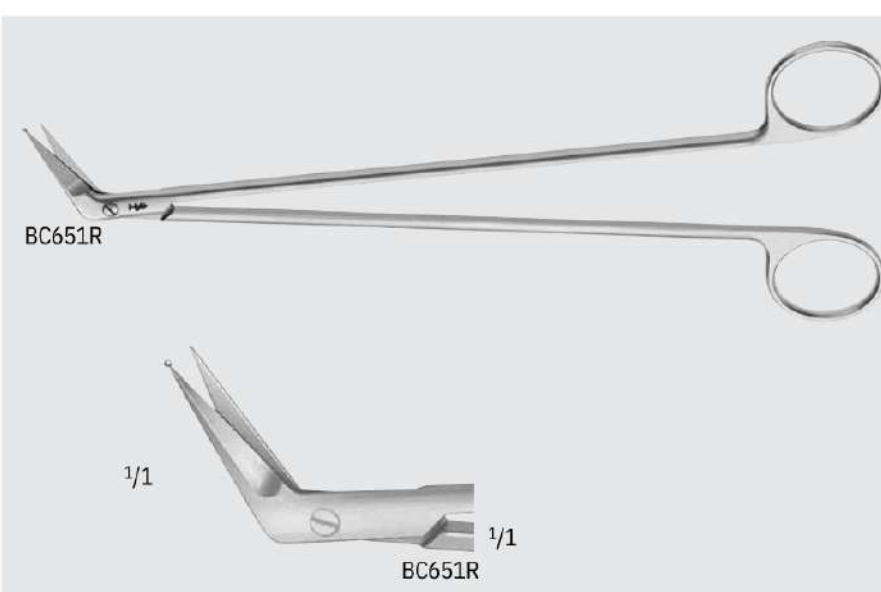

Cardiovascular

Delicate Scissors



BC653R-BC654R

1/2

DIETHRICH Vessel Scissors

Catalog Number	Tip	Blade Angle	Blade Length (mm)	Length (in.)
BC653	S/	90°	1	6 3/4
R	S	120°	2	6 3/4
BC654	S/		1	
R	S		0	



1/1

BC653R

1/1



1/1

BC654R

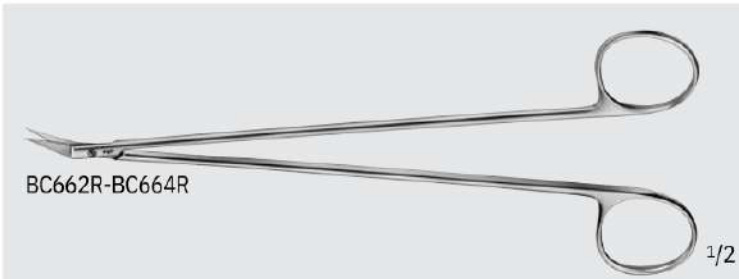

BC662R-BC664R

1/2

DIETHRICH-HEGEMANN Vessel Scissors

Catalog Number	Tip	Blade Angle	Blade Length (mm)	Length (in.)
BC662R	S/S	25	1	7
BC663R	S/S	°	5	7
BC664R	S/S	45	1	7
		°	5	
		60	1	
		°	5	



1/1

BC662R

1/1

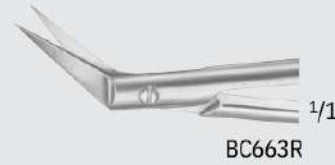

1/1

BC663R

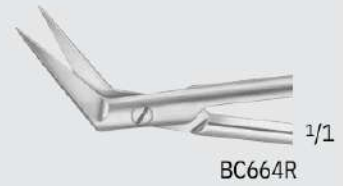

1/1

BC664R

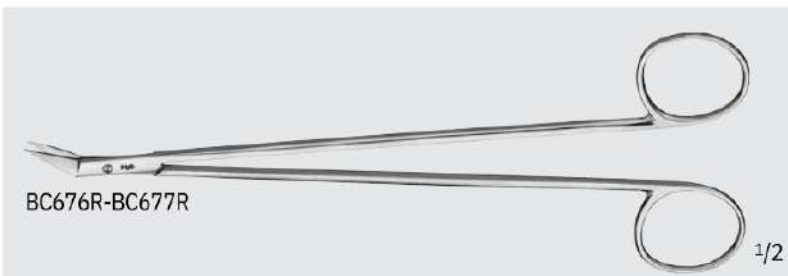

BC676R-BC677R

1/2

DIETHRICH Coronary Artery Scissors

Catalog Number	Tip	Blade Angle	Blade Length (mm)	Length (in.)
BC676	S/	25	1	7 1/4
R	S	°	3	7 1/4
BC677	S/	45	1	
R	S	°	4	



1/1

BC676R



1/1

BC677R

COOLEY Arteriotomy Scissors

Catalog Number	Tip	Blade Angle	Blade Length (mm)	Length (in.)
BC678	B/	30	21.5	8 7/8
R	B	°	21.5	10 3/4
BC679	B/	30		
R	B	°		

BC678R-BC679R

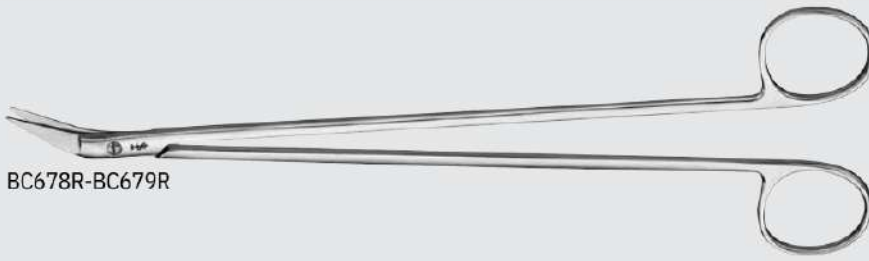

DEBAKEY Vessel Scissors

Catalog Number	Tip	Blade Angle	Blade Length (mm)	Length (in.)
BC656	S/	45	1	6 1/8
R	S	°	8	6 1/8
BC657	S/	60	1	
R	S	°	8	

BC656R-BC657R

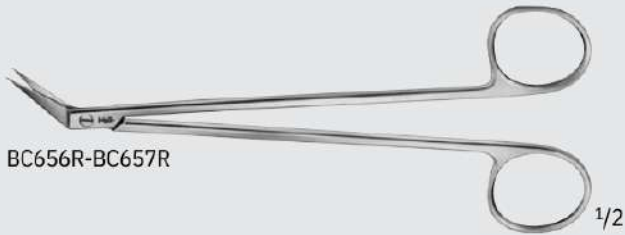

DEBAKEY O set Scissors, S-Shaped

Catalog Number	Tip	Blade Angle	Blade Length (mm)	Length (in.)
BC669R	S/S	45°	24	6 1/8

BC669R

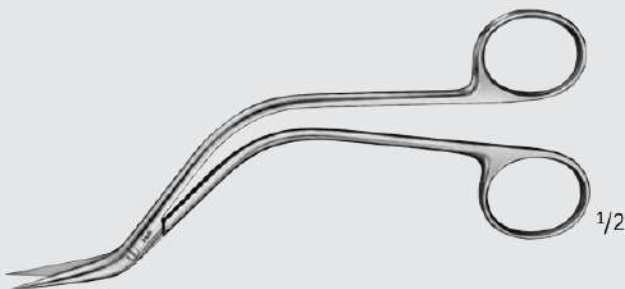

1/1

BC669R



INCHES

Cardiovascular

Delicate Scissors

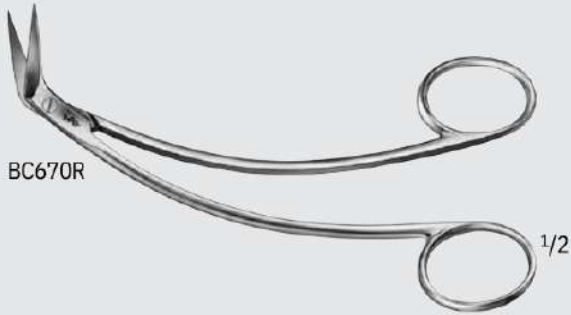

FAVOLORO Artery Scissors

Catalog Number	Tip	Blade Angle	Blade Length (mm)	Length (in.)
BC670R	S/S	45°	20	5 1/2

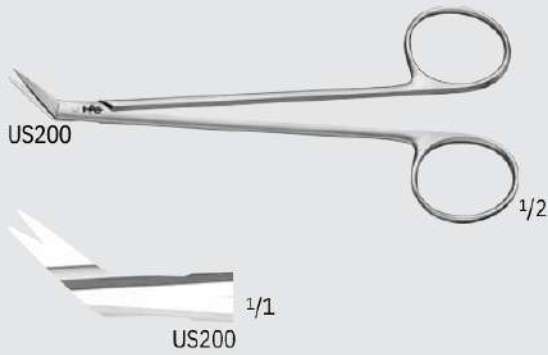

POTTS Vascular Scissors

Catalog Number	Tip	Blade Angle	Blade Length (mm)	Length (in.)
US200	S/S	45°	13	5 1/4



Valve Lea et Excision Scissors

Catalog Number	Tip	Blade Angle	Length (in.)
MB064R	B/B	45°	5 3/4

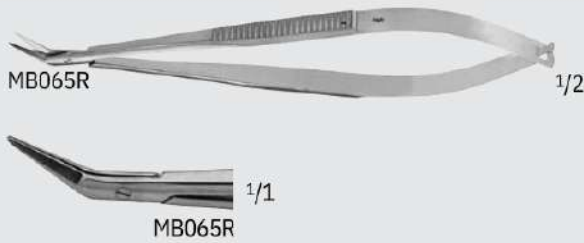

POTTS Arteriotomy Scissors

Catalog Number	Tip	Blade Angle	Length (in.)
MB065R	B/B	60°	5 3/8

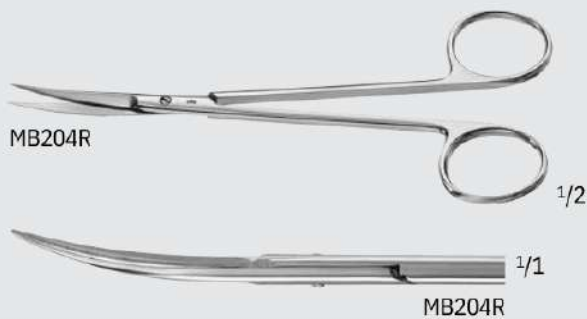

COOLEY Neonatal Scissors

Catalog Number	Tip	Blade	Length (in.)
MB204R	S/S	CVD	5 3/4





BC515R-BC535R

1/2

DIETRICH-POTTS Micro Scissors

Catalog Number	Tip	Blade	Blade Angle	Blade Length (mm)	Length (in.)
BC515R	S/S	X-DEL	25°	8	7
BC516R	S/S	X-DEL	45°	8	7
BC517R	S/S	X-DEL	60°	8	7
BC518R	S/S	X-DEL	90°	8	7
BC519R	S/S	X-DEL	125°	8	7
BC531R	S/S	DEL	25°	10	7
BC532R	S/S	DEL	45°	10	7
BC533R	S/S	DEL	60°	10	7
BC534R	S/S	DEL	90°	10	7
BC535R	S/S	DEL	125°	10	7
BC522R	S/S	FINE	25°	12	7
BC523R	S/S	FINE	45°	12	7
BC524R	S/S	FINE	60°	12	7
BC525R	S/S	FINE	90°	12	7
BC526R	S/S	FINE	125°	12	7

Blade Length: 8 MM

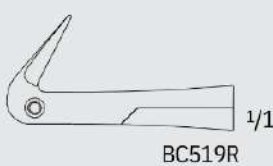
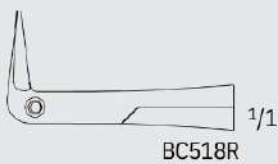
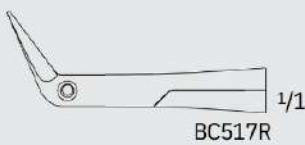
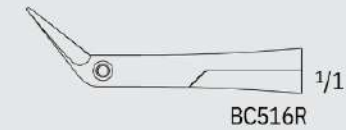
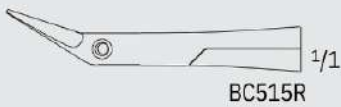

Blade Length: 10 MM

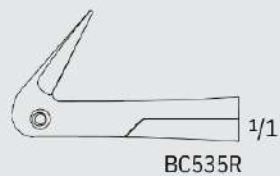
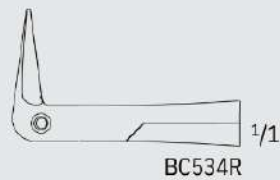
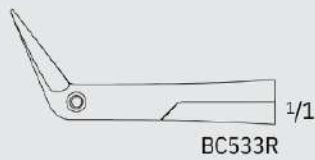
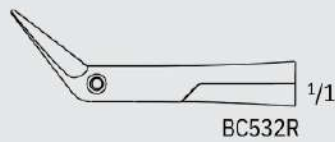

Blade Length: 12 MM

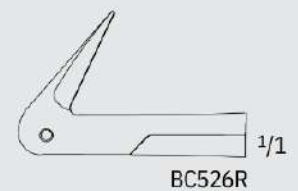
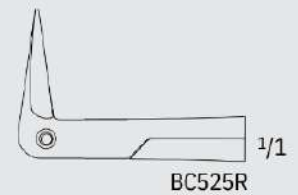
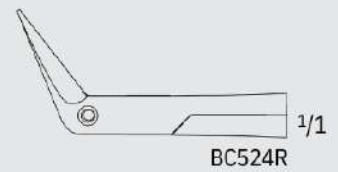
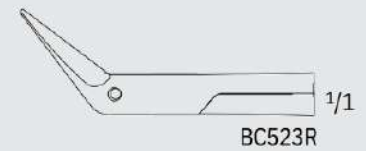
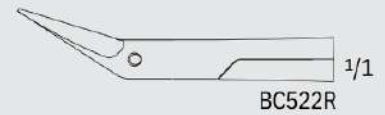

Cardiovascular

Scissors



VASCARIBRO



DIETHRICH SuperCut Scissors

Catalog Number	Tip	Blade	Length (in.)
MG346R	S/	25°	7
MG347R	S	45°	7
MG348R	S/	60°	7
MG349R	S	90°	7
MG350R	S/	125°	7

S
S/
S
S/
S



DUROTIP TC Tungsten Carbide Scissors ■ Excellent cutting accuracy ■ Long working life ■ Gold-plated rings

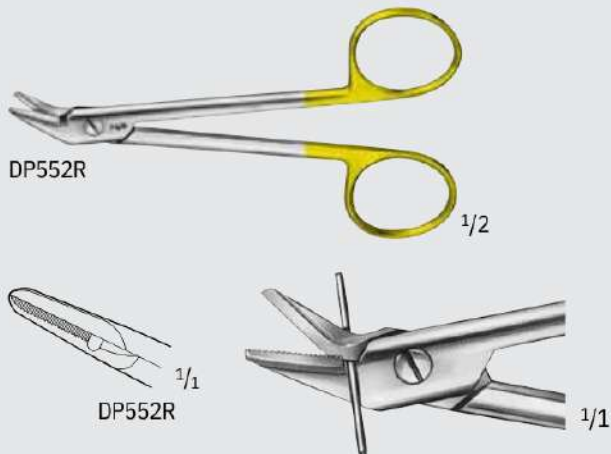

DUROTIP TC Wire Cutting Scissors

Catalog Number	Blade	For Wire Size	Length (in.)
DP552R	1-SERRATED	SOFT, UP TO 1.2 MM AND HARD UP TO 0.8 MM	4 3/4

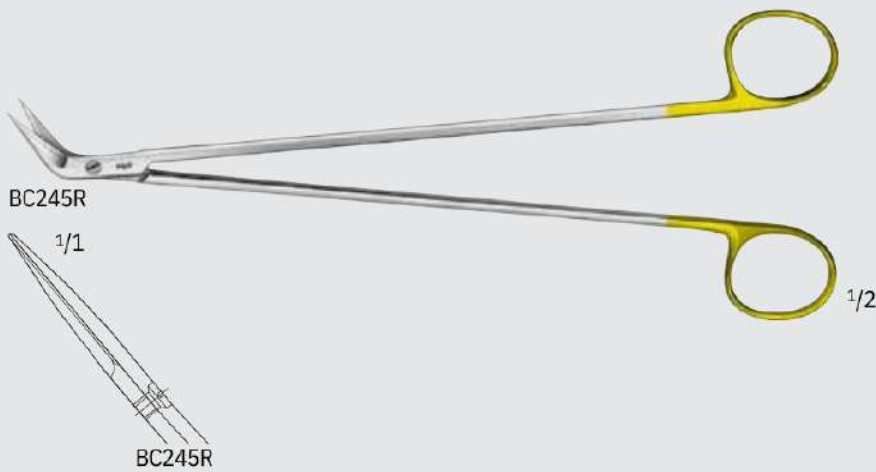

DUROTIP TC DEBAKEY Vascular Scissors

Catalog Number	Tip	Blade Angle	Blade Length (mm)	Length (in.)
BC245R	S/S	60°	21	8 3/4

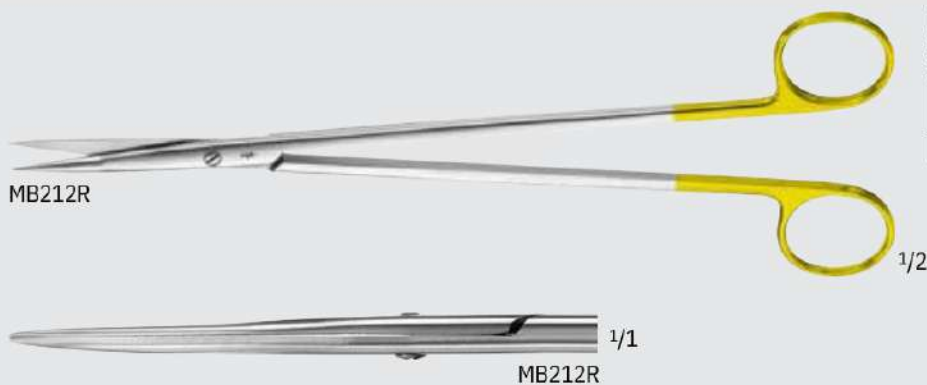

DUROTIP TC DEMARTEL Vascular Scissors

Catalog Number	Tip	Blade	Length (in.)
MB212R	S/S	CVD	6 3/4

Cardiovascular

DUROTIP™ TC Scissors



VASCULAR



BC258R-BC259R

1/2

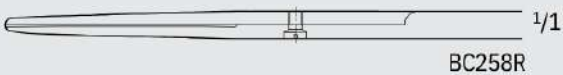

BC258R

1/1

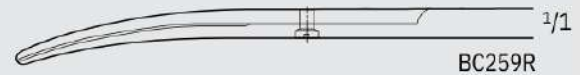

BC259R

1/1

DUROTIP TC Baby METZENBAUM Dissecting Scissors, Delicate

Catalog Number	Tip	Blade	Length (in.)
BC258	B/	STR	5 3/4
R	B	CVD	5 3/4
BC259	B/		
R	B		



BC260R-BC265R

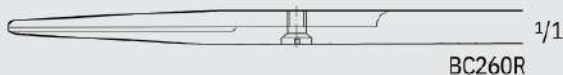

BC260R

1/1

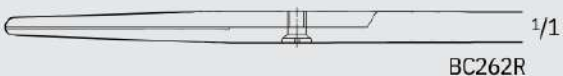

BC262R

1/1

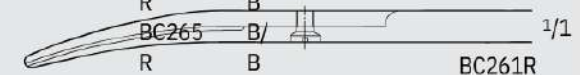

BC261R

1/1

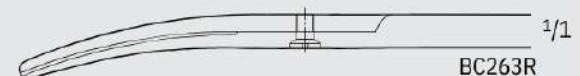

BC263R

1/1

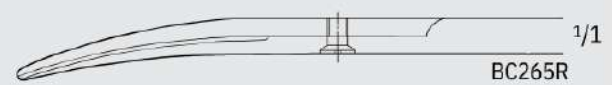

BC265R

1/1

DUROTIP TC METZENBAUM Dissecting Scissors

Catalog Number	Tip	Blade	Length (in.)
BC260	B/	STR	5 3/4
R	B	STR	7
BC262	B/	CVD	5 3/4
R	B	CVD	7
BC261	B/	CVD	7 7/8
R	B	CVD	9

BC263

B/

R

B

BC265

B/

R

B

BC287

B/

R

B



BC287R

1/2



BC287R

1/1

DUROTIP TC METZENBAUM Dissecting Scissors, Delicate

Catalog Number	Tip	Blade	Length (in.)
MB205R	S/	STR	9 1/4
MB207R	S	CVD	5 3/4
MD496	S/	CVD	7
MB206R	S	CVD	9 1/4

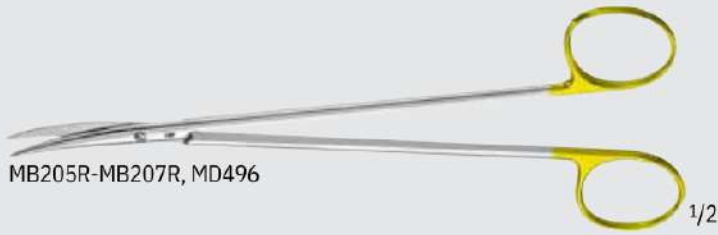

MB205R-MB207R, MD496

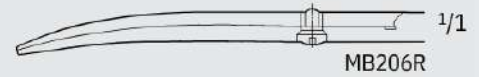

DUROTIP TC MAYO Dissecting Scissors

Catalog Number	Tip	Blade	Length (in.)
BC558R	B/	STR	9
BC559R	B/	CVD	9



BC558R-BC559R



Cardiovascular

DUROTIP™ TC Scissors



Wavecut

■ Wavecut scissors have one serrated cutting edge to prevent tissue from slipping.

The **W** after the item number indicates the scissors are the wavecut style, e.g. BC211W.

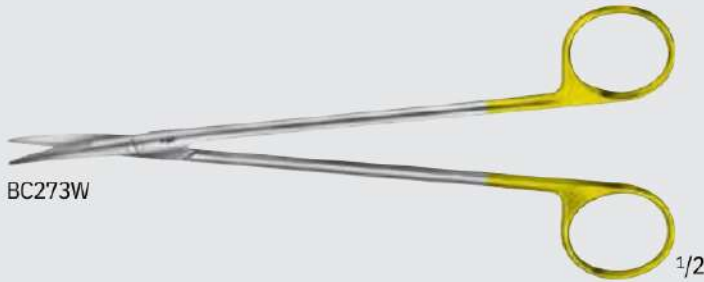

BC273W

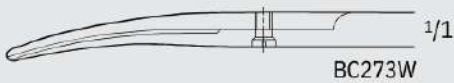

DUROTIP TC TOENNIS-ADSON Wavecut Dissecting Scissors

Catalog Number	Tip	Blade	Length (in.)
BC273W	B/B	CVD	6 7/8



BC259W

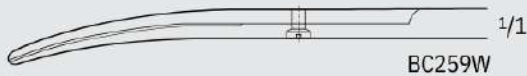

DUROTIP TC Baby METZENBAUM Wavecut Dissecting Scissors, Delicate

Catalog Number	Tip	Blade	Length (in.)
BC259W	B/B	CVD	5 3/4



BC261W-BC265W

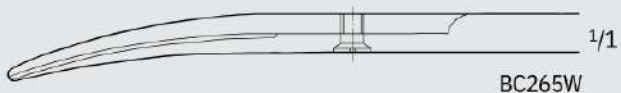
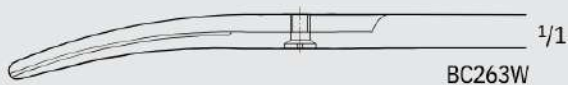
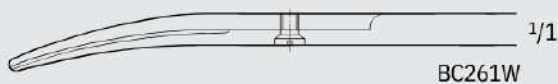

DUROTIP TC METZENBAUM Wavecut Dissecting Scissors

Catalog Number	Tip	Blade	Length (in.)
BC261W	B/	CV	5 3/4
BC263W	B	D	7
BC265W	B/	CV	7 7/8
	B	D	
	B/	CV	
	B	D	



**DUROTIP TC NELSON-METZENBAUM
 Wavecut Dissecting Scissors**

Catalog Number	Tip	Blade	Length (in.)
BC267W	B/B	CVD	9
BC279W	B/B	CVD	10 1/4
BC281W	B/B	CVD	11

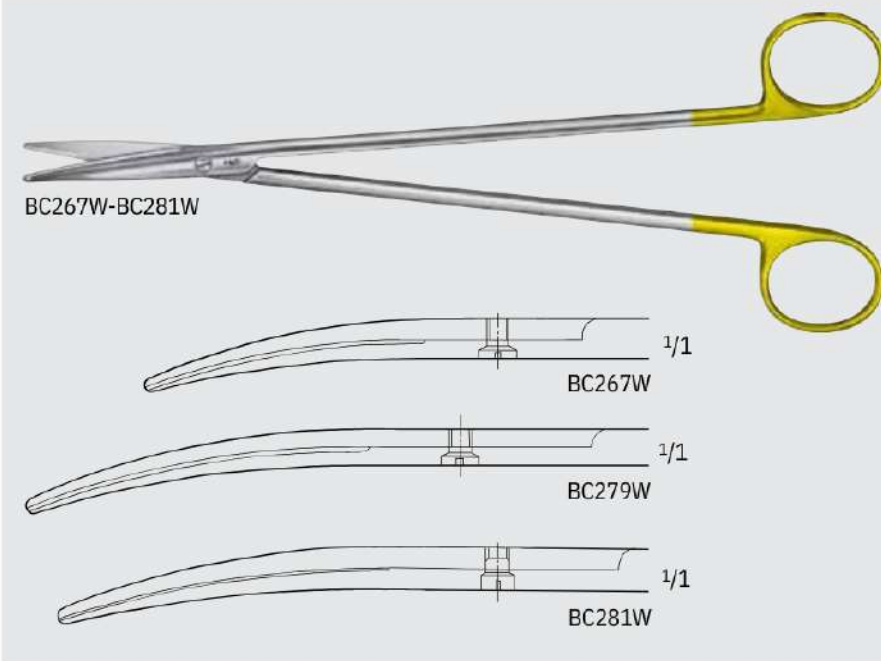

**DUROTIP TC METZENBAUM Wavecut
 Dissecting Scissors, Delicate**

Catalog Number	Tip	Blade	Length (in.)
BC271W	B/B	CVD	7
BC275W	B/B	CVD	7 7/8
BC277W	B/B	CVD	9

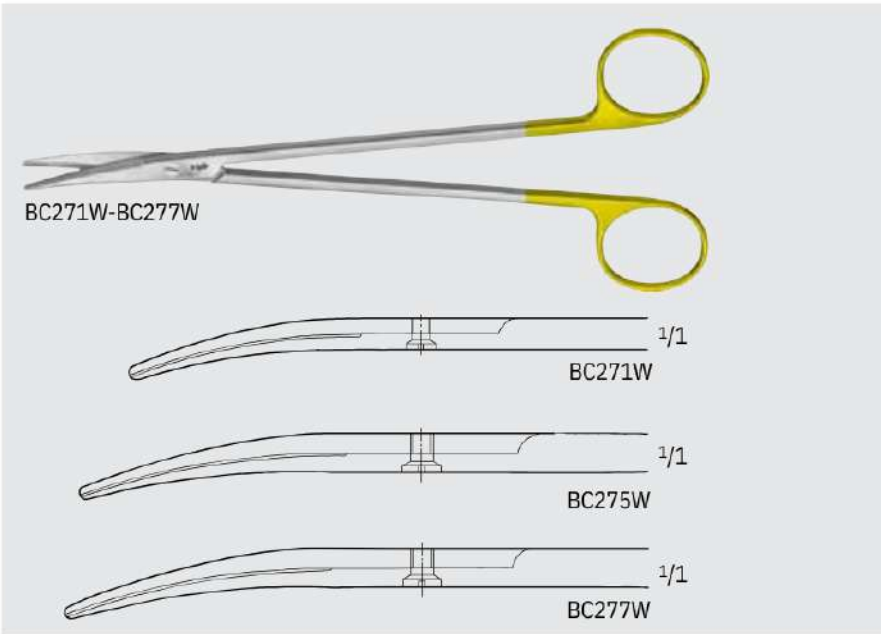

**DUROTIP TC METZENBAUM Wavecut
 Dissecting Scissors, Heavy**

Catalog Number	Tip	Blade	Length (in.)
BC287W	B/B	CVD	9

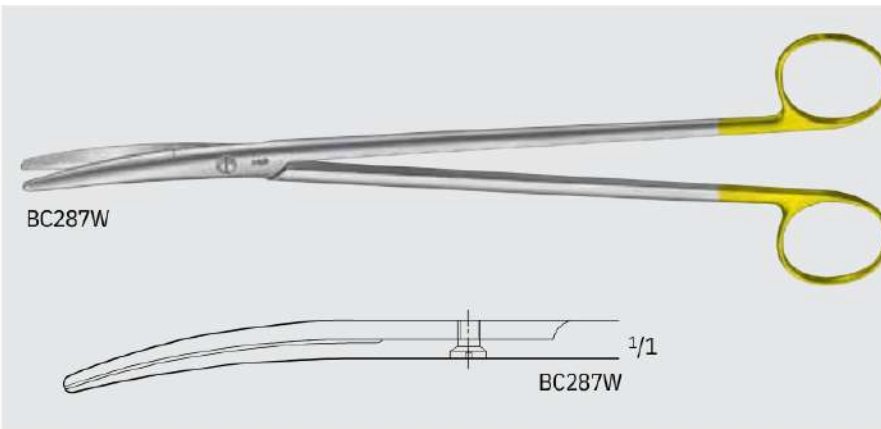

INCHES

Cardiovascular

DUROTIP™ TC Scissors

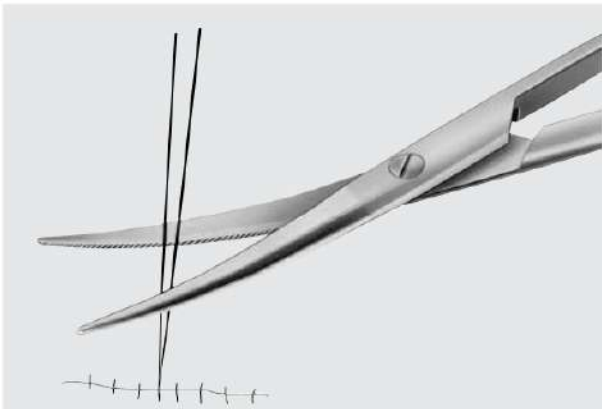

DUROTIP TC Ligature Scissors

■ Carbide inserts help ensure sharp cutting edge

(also in the distal area of the blades).

■ Wavecut helps prevent suture materials from slipping.

■ Identified by 1 gold-plated ring.



BC294W-BC298W

DUROTIP TC Ligature Wavecut Scissors

Catalog Number	Tip	Blade	Length (in.)
BC294W	B/	CVD	5 3/4
BC295W	B	CVD	7
BC296W	B/	CVD	9
BC297W	B	CVD	10 1/4
BC298W	B/	CVD	13 3/4

B
B/
B
B/
B

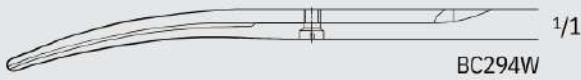

BC294W

1/1

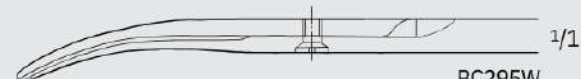

BC295W

1/1

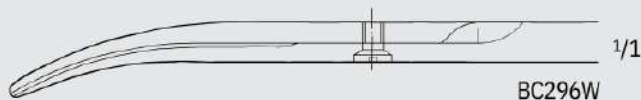

BC296W

1/1



BC297W

1/1

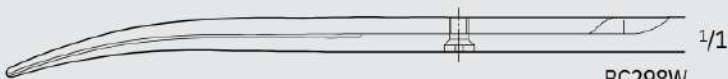

BC298W

1/1



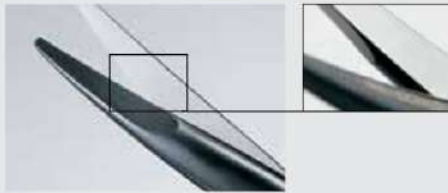

Microtome Edge

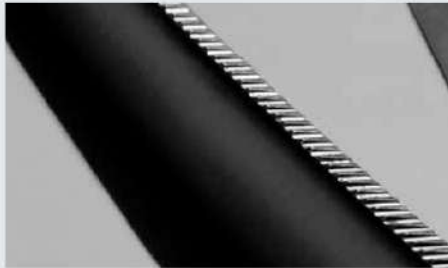

Wavecut

Noir Supreme Cut Scissors

■ **Noir**

The combination of the renowned Aesculap Tungsten Carbide technology with the Aesculap Noir coating results in an extremely high surface hardness and therefore high wear resistance in daily hospital use.

■ **Microtome edge**

The extremely sharp cutting edge of the scissors blade facilitates gentle cutting of tissue with minimal use of force.

■ **Wavecut** helps prevent tissue from slipping out during the cutting process.

■ The **WB** after the item number indicates the Noir scissors are the wavecut style, e.g. BC211WB.

For more information about Noir Supreme Cut Scissors see our brochure number **DOC637**.



Noir MAYO Dissecting Scissors

Catalog Number	Tip	Blade	Length (in.)
BC252B	B/	STR	6 3/4
BC253B	B	CVD	6 3/4
BC253WB	B/	CVD	6 3/4



Noir MAYO-LEXER Dissecting Scissors

Catalog Number	Tip	Blade	Length (in.)
BC284B	B/	CV	6 1/2
BC284WB	B	D	6 1/2



B/
B

CV
D



INCHES

Cardiovascular

Noir™ Supreme Cut Scissors



Noir LEXER Dissecting Scissors

Catalog Number	Tip	Blade	Length (in.)
BC283B	B/	DEL,	6 1/2
BC283WB	B	CVD	6 1/2
	B/	DEL,	
	B	CVD	



Noir Iris Dissecting Scissors

Catalog Number	Tip	Blade	Length (in.)
BC210B	S/	STR	4 1/4
BC211B	S	CVD	4 1/4
BC211WB	S/	CVD	4 1/4
	S		
	S/		
	S		



Noir TOENNIS-ADSON Dissecting Scissors

Catalog Number	Tip	Blade	Length (in.)
BC273B	B/	DEL,	6 7/8
BC273WB	B	CVD	6 7/8
	B/	DEL,	
	B	CVD	





BC261B-BC277WB



1/1

BC261B, BC261WB



1/1

BC263B, BC263WB



1/1

BC271B, BC271WB



1/1

BC265B, BC265WB



1/1

BC275B, BC275WB



1/1

BC267B, BC267WB



1/1

BC277B, BC277WB

Noir METZENBAUM Dissecting Scissors

Catalog Number	Tip	Blade	Length (in.)
BC261B	B/	CVD	5 3/4
BC261WB	B	CVD	5 3/4
BC263B	B/	CVD	7
BC263WB	B	CVD	7
BC271B	B/	DEL, CVD	7
BC271WB	B	DEL, CVD	7
BC265B	B/	CVD	7 7/8
BC265WB	B	CVD	7 7/8
BC275B	B/	DEL, CVD	7 7/8
BC275WB	B	DEL, CVD	7 7/8
BC267B	B/	CVD	9
BC267WB	B	CVD	9
BC277B	B/	DEL, CVD	9
BC277WB	B	DEL, CVD	9

B/
B
B/
B
B/
B
B
B/
B
B/
B
B



Cardiovascular

Noir™ Supreme Cut Scissors



Noir NELSON-METZENBAUM Dissecting Scissors

Catalog Number	Tip	Blade	Length (in.)
BC279B	B/B	DEL, CVD	10 1/4
BC279WB	B/B	DEL, CVD	10 1/4
BC281B	B/B	DEL, CVD	11
BC281WB	B/B	DEL, CVD	11



BC279B-BC281WB



BC279B, BC279WB



BC281B, BC281WB



FD020R-FD021R



FD020R



FD021R

MILLESI Micro Scissors

Catalog Number	Tip	Blade	Handle	Length (in.)
FD020R/S/S		STR, SERR	FLAT,	6 1/4
FD021R/S/S		CVD, SERR	SERR	6 1/4
			FLAT, SERR	



FD028R

1/1

FD028R



BIEMER Vein Scissors

Catalog Number	Blade	Handle	Length (in.)
FD028R	STR	FLAT, SERR	5 1/8

MILLESI Micro Scissors

Catalog Number	Tip	Blade	Handle	Length (in.)
FD020R/S/S		STR, SERR	FLAT,	6 1/4
FD021R/S/S		CVD, SERR	SERR	6 1/4
			FLAT, SERR	



FD022R-FD023R

1/2



FD022R



FD023R

YASARGIL Micro Vessel Scissors

Catalog Number	Blade	Handle	Length (in.)
FD022R	STR	FLAT,	7 1/4
FD023R	CVD	SERR	7 1/4
		FLAT, SERR	



INCHES

Cardiovascular

Micro Scissors



FM430R-FM474R

1/2

Blade: **STR**

Blade: **25°**

Blade: **45°**



FM444R

1/1



FM431R

1/1



FM432R

1/1



FM442R

1/1



FM437R

1/1



FM438R

1/1

Blade: **CVD**



FM430R

1/1



FM451R

1/1



FM452R

1/1



FM436R

1/1



FM470R

1/1



FM471R

1/1

Blade: **60°**

Blade: **90°**

Blade: **125°**



FM433R

1/1



FM434R

1/1



FM435R

1/1



FM439R

1/1



FM440R

1/1



FM441R

1/1



FM453R

1/1



FM454R

1/1



FM455R

1/1



FM472R

1/1



FM473R

1/1



FM474R

1/1

Micro Scissors, Flat Handle

Catalog Number	Tip	Blade	Blade Angle	Blade Length (mm)	Length (in.)	
FM444R	S/	X-DEL	STR	7	6 1/2	
FM430R	S	X-DEL	CVD	7	6 1/2	
FM431R	S/	X-DEL	25°	7	6 1/2	
FM432R	S	X-DEL	45°	7	6 1/2	
FM433R	S/	X-DEL	60°	7	6 1/2	
FM434R	S	X-DEL	90°	7	6 1/2	
FM435R	S/	X-DEL	125°	7	6 1/2	
FM442R	S	DE	STR	10	6 1/2	
FM436R	S/	L	CVD	10	6 1/2	
FM437R	S	DE	25°	10	6 1/2	
FM438R	S/	L	45°	10	6 1/2	
FM439R	S	DE	60°	10	6 1/2	
FM440R	S/	L	90°	10	6 1/2	
FM441R	S	DE	125°	10	6 1/2	
FM451R	S/	L	FINE	25°	15	6 1/2
FM452R	S/1	DE	FINE	45°	15	6 1/2
FM453R	S/1	L	FINE	60°	15	6 1/2
FM454R	S/1	FINE	FINE	90°	15	6 1/2
FM455R	S/1	FINE	125°	15	6 1/2	
FM470R	S/S	FINE	FINE	15	6 1/2	
FM471R	S/S	FINE	125°	15	6 1/2	
FM472R	S/S		60°	15	6 1/2	
FM473R	S/S		90°			
FM474R	S/S		125°			

FM451R BALL-TIP
 FM452R BALL-TIP
 FM453R BALL-TIP
 FM454R BALL-TIP
 FM455R BALL-TIP
 FM470R S/S
 FM471R S/S
 FM472R S/S
 FM473R S/S
 FM474R S/S

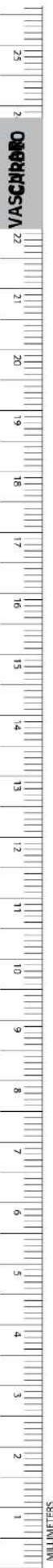



FM476R-FM508R

1/2

Blade: STR



FM488R

1/1

Blade: 25°



FM504R

1/1

Blade: 45°



FM505R

1/1

Blade: CVD



FM503R

1/1



FM482R

1/1



FM483R

1/1



FM481R

1/1



FM489R

1/1



FM490R

1/1



FM476R

1/1



FM477R

1/1

Blade: 60°



FM506R

1/1



FM507R

1/1



FM508R

1/1



FM484R

1/1



FM485R

1/1



FM486R

1/1



FM491R

1/1



FM492R

1/1



FM493R

1/1



FM478R

1/1



FM479R

1/1



FM480R

1/1

Blade: 90°

Blade: 125°

Micro Scissors, Round Handle

Catalog Number	Tip	Blade	Blade Angle	Blade Length (mm)	Length (in)
FM503	S/	X-DEL	CVD	7	6 1/2
R	S	X-DEL	25X-	7	6 1/2
FM504	S/	DEL	X-DEL	7	6 1/2
R	S	X-DEL	45X-	7	6 1/2
FM505	S/	DEL	125°	7	6 1/2
R	S		60	7	6 1/2
FM506	S/	DE	STR	10	6 1/2
R	S	L	90°	10	6 1/2
FM507	S/	DE	25°	10	6 1/2
R	S	L	45°	10	6 1/2
FM508	S/	DE	60°	10	6 1/2
R	S	L	90°	10	6 1/2
FM488	S/	DE	125°	10	6 1/2
R	S	L			
FM489R	S/	DEL	25°	10	6 1/2
R	S	L			
FM482	S/	DE			
FM490R	S/	DEL	45°	10	6 1/2
FM483	S/	DE			
R	S/	L			
FM484R	S/	DEL	60°	10	6 1/2
R	S/	L			
FM485	S/				
FM492R	S/	DEL	90°	10	6 1/2
FM486	S/				
R	S/				
FM493R	S/	DEL	125°	10	6 1/2
R	S/				
FM476	S/S	FIN	25°	15	6 1/2
R	S/S	E	45°	15	6 1/2
FM477	S/S	FIN	60°	15	6 1/2
R	S/S	E	90°	15	6 1/2
FM478	S/S	FIN	125°	15	6 1/2
R	S/S	E			
FM479		FIN			
R		E			
FM480		FIN			
R		E			



INCHES

Cardiovascular

Special CV Scissors



FD056R-FD057R

NAGEL Micro Scissors

Catalog Number	Tip	Blade	Length (in.)
FD056R	S/S	45°	7-7/8
FD057R	PROBE	45°	7-7/8



FD056R



FD057R



FD059R

DEBAKEY Circum ex Micro Scissors

Catalog Number	Tip	Blade	Length (in.)
FD059R	S/S	125°	7-1/2



FD059R



FD100R-FD103R

Micro Scissors

Catalog Number	Tip	Blade	Handle	Length (in.)
FD100R	S/S	STR	ROUND	5-3/4
FD101R	S/S	CVD	ROUND	5-3/4
FD103R	B/B	CVD	ROUND	5-3/4



FD100R



FD101R



FD103R

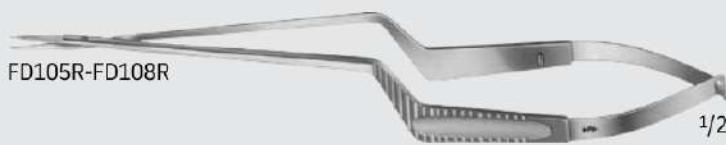

FD105R-FD108R

Micro Vessel Scissors

Catalog Number	Tip	Blade	Length (in.)
FD105R	S/S	STR	7-1/2
FD106R	S/S	CVD	7-1/2
FD107R	S/S	DEL, STR	7-1/2
FD108R	S/S	DEL, CVD	7-1/2



FD105R



FD106R



FD107R



FD108R





BM563R-BM564R



CASTROVIEJO Micro Needle Holder, W/ Catch

Catalog Number	Tip	Jaw	Length (in.)
BM563R	STR	SMOOT	5 3/4
BM564R	CVD	H SMOOT H	5 3/4



FD045R-FD046R



JACOBSON Micro Needle Holder

Catalog Number	Handle	Jaw	Length (in.)
FD045R	W/O CATCH	SMOOT	7 1/4
FD046R	W/ CATCH	H SMOOT H	7 1/4



FD048R



Micro Needle Holder, W/ Catch

Catalog Number	Jaw	Length (in.)
FD048R	SMOOTH	7 7/8



FD076R-FD079R



Micro Needle Holder, W/O Catch

Catalog Number	Tip	Jaw	Length (in.)
FD076R	STR	SMOOT	6 1/4
FD079R	CVD	H SMOOT H	6 1/4



FD080R-FD081R



Micro Needle Holder, W/O Catch

Catalog Number	Tip	Jaw	Length (in.)
FD080R	STR	SMOOT	7 1/4
FD081R	CVD	H SMOOT H	7 1/4

Cardiovascular

Micro Needle Holders



Micro Needle Holder, Bayonet-Shaped

Catalog Number	Tip	Length (in.)
FD120R	CVD-UP	7 3/4

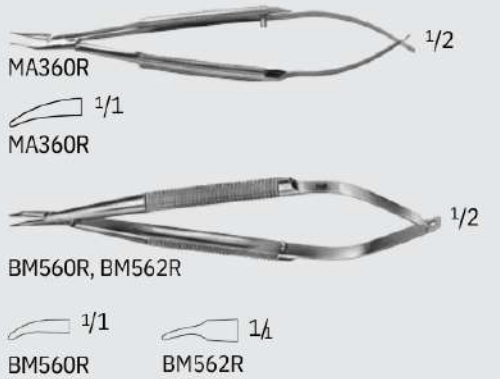

BARRAQUER Micro Needle Holder, Round Knurled Handle

Catalog Number	Tip	Handle	Length (in.)
FD230R	STRW/O CATCH		4 3/4
MA352R	STRW/O CATCH		5 1/4
BM562R	CVD, DELW/O CATCH		4 3/4
MA360R	CVDW/O CATCH		4 1/4
BM560R	CVDW/O CATCH		4 1/2
FD231R	CVDW/O CATCH		4 3/4
MA357R	CVDW/O CATCH		5 1/4
FD232R	STRW/ CATCH		4 3/4
MA351R	STRW/ CATCH		5 1/4
FD233R	CVDW/ CATCH		4 3/4
MA358R	CVDW/ CATCH		5 1/4

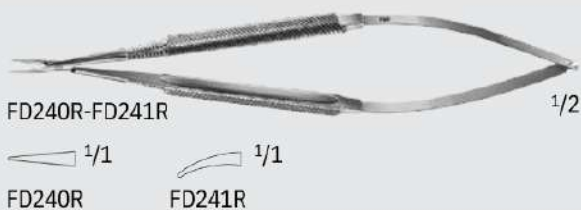
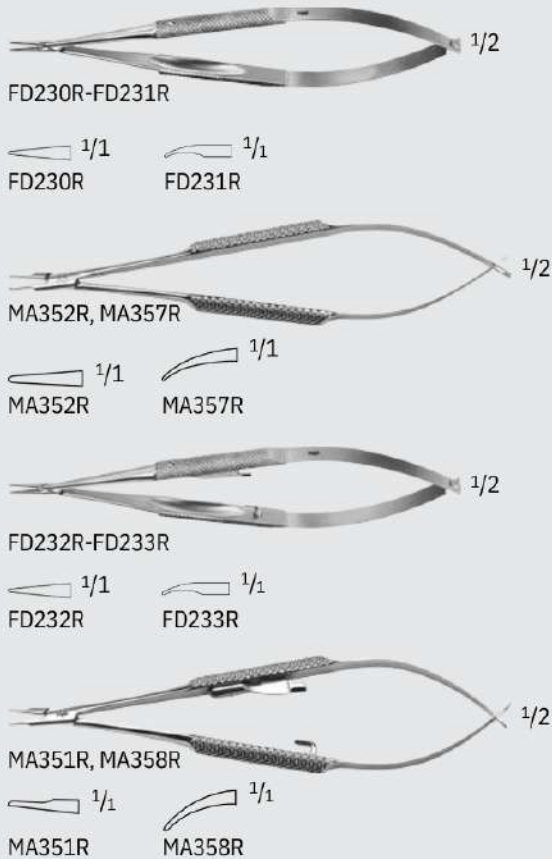

REILL Micro Needle Holder, W/O Catch

Catalog Number	Tip	Jaw	Length (in.)
FD240	STR	SMOOTH	6
R	CVD	H	6
FD241		SMOOTH	
R		H	



Cardiovascular

Micro Needle Holders



FD242R-FD243R



FD242R



FD243R

Micro Needle Holder, Round Knurled Handle W/ Catch

Catalog Number	Tip	Jaw	Length (in.)
FD242R	STR	SMOOT	6
FD243R	CVD	H	6
		SMOOT	
		H	



FD244R-FD245R



FD244R



FD245R

Micro Needle Holder, Round Knurled Handle W/O Catch

Catalog Number	Tip	Jaw	Length (in.)
FD244R	STR	SMOOT	7 1/4
FD245R	CVD	H	7 1/4
		SMOOT	
		H	



FD246R-FD247R



FD246R



FD247R

Micro Needle Holder, Round Knurled Handle W/ Catch

Catalog Number	Tip	Jaw	Length (in.)
FD246R	STR	SMOOT	7 1/4
FD247R	CVD	H	7 1/4
		SMOOT	
		H	



FM392R



FM392R

Round Knurled Handle Micro Needle Holder, W/ Catch

Catalog Number	Tip	Jaw	Length (in.)
FM392R	STR	SMOOTH	9



FM021R



FM021R

MUELLER Micro Needle Holder, Plastic Handle W/ Catch

Catalog Number	Tip	Length (in.)
FM021R	CVD	5 3/4



Cardiovascular

DUROGRIP™ TC Micro Needle Holders

Aesculap features Needle Holders with Tungsten Carbide (TC) inserts. A smooth jaw and three different serration patterns are available, depending on the size of the suture needle.

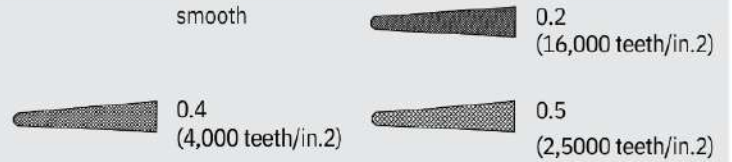

We recommend carbide inserts as follows:

Jaw Surface

Smooth
 0.2 mm pitch of serration
 0.4 mm pitch of serration
 0.5 mm pitch of serration

Suture Material

9/0 - 11/0
 6/0 - 10/0
 4/0 - 6/0
 up to 3/0

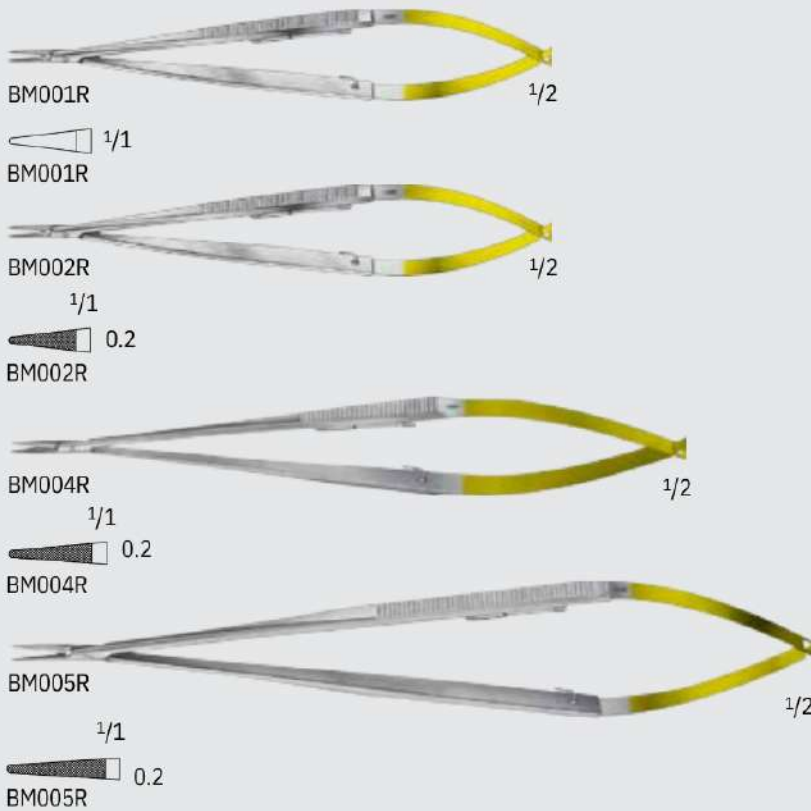

DUROGRIP TC CASTROVIEJO Micro Needle Holder, Flat Handle

Catalog Number	Jaw	Length (in.)
BM001R	SMOOTH	5 3/4
BM002R	SERR	5 3/4
BM004R	SERR	7
BM005R	SERR	8 1/2



DUROGRIP TC SPENCER Coronary Needle Holder

Catalog Number	Jaw	Length (in.)
US126	SMOOTH	7



DUROGRIP™ TC Micro Needle Holders

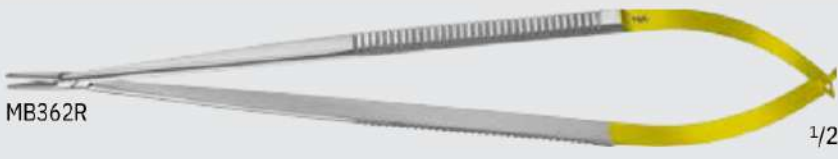

MB362R 1/2

1/1
MB362R

DUROGRIP TC JACOBSON Needle Holder, Flat Handle W/O Catch

Catalog Number	Jaw	Length (in.)
MB362R	SERR	8 3/4



MB214R 1/2

1/1
MB214R

DUROGRIP TC Micro Needle Holder, Flat Handle W/ Catch

Catalog Number	Jaw	Length (in.)
MB214R	SMOOTH	7 1/4



MB215R 1/2

1/1
MB215R

DUROGRIP TC MILLS Vascular Needle Holder, Round Handle W/ Catch

Catalog Number	Jaw	Length (in.)
MB215R	SERR	8



FM388R-FM390R

1/1 0.2
FM388R

1/1 0.2
FM390R

DUROGRIP TC Micro Needle Holder, Round Handle W/ Catch

Catalog Number	Jaw	Length (in.)
FM388R	SER	7
FM390R	R SER R	7 7/8



MG070R 1/2

1/1 0.2
MG070R

DUROGRIP TC GIANNINI Needle Holder

Catalog Number	Jaw	Length (in.)
MG070R	SERR	10 1/2



Cardiovascular

Dia Dust™ Micro Needle Holders



■ Dia Dust diamond dust coating ensures an even harder and more wear resistant surface on the inside of the jaws. The structure of the Dia Dust coating enables a reliable grip for the needles, sutures, and tissue.



FM540R-FM544R



Dia Dust Micro Needle Holder, Flat Handle W/ Catch

Catalog Number	Tip	Suture Size	Length (in.)
FM540R	STR	7/0 AND SMALLER	6 3/4
FM541R	STR	5/0 AND SMALLER	5 3/4
FM542R	STR	5/0 AND SMALLER	7 1/4
FM543R	STR	5/0 AND SMALLER	8 1/4
FM544R	STR	5/0 AND SMALLER	9



FM545R-FM549R



1/2

Dia Dust Micro Needle Holder, Flat Handle W/O Catch

Catalog Number	Tip	Suture Size	Length (in.)
FM545R	STR	7/0 AND SMALLER	6 3/4
FM546R	STR	5/0 AND SMALLER	5 3/4
FM547R	STR	5/0 AND SMALLER	7 1/4
FM548R	STR	5/0 AND SMALLER	8 1/4
FM549R	STR	5/0 AND SMALLER	9



FM550R-FM552R



1/2

Dia Dust Micro Needle Holder, Flat Knurled Handle W/ Catch

Catalog Number	Tip	Suture Size	Length (in.)
FM550R	STR	5/0 AND SMALLER	7 1/4
FM551R	STR	5/0 AND SMALLER	8 1/4
FM552R	STR	5/0 AND SMALLER	9

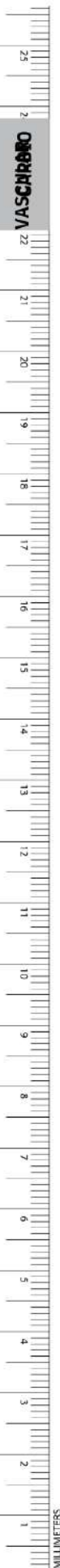



FM553R-FM555R



FM553R-FM555R

Dia Dust Micro Needle Holder, Flat Knurled Handle W/O Catch

Catalog Number	Tip	Suture Size	Length (in.)
FM553R	STR	5/0 AND SMALLER	7 1/4
FM554R	STR	5/0 AND SMALLER	8 1/4
FM555R	STR	5/0 AND SMALLER	9



FD258R-FD259R

1/2



FD258R



FD259R

Dia Dust Micro Needle Holder, Golf Ball Handle Design

Catalog Number	Tip	Suture Size	Length (in.)
FD258R	STR	7/0 AND SMALLER	7
FD259R	CVD	7/0 AND SMALLER	7



FM218R-FM230R



FM218R-FM230R



FM221R-FM223R



FM221R-FM223R

Dia Dust Micro Needle Holder, Round Handle W/ Catch

Catalog Number	Tip	Suture Size	Length (in.)
FM218R	STR	4/0 AND SMALLER	7 1/4
FM228R	STR	4/0 AND SMALLER	8 1/4
FM230R	STR	4/0 AND SMALLER	9
FM221R	CVD	4/0 AND SMALLER	8 1/4
FM223R	CVD	4/0 AND SMALLER	9



Cardiovascular

Dia Dust™ Micro Needle Holders



FM520R-FM568R



FM520R, FM521R, FM563R, FM565R, FM567R



FM522R, FM523R, FM564R, FM566R, FM568R

Dia Dust Micro Needle Holder, Round Handle W/ Catch

Catalog Number	Tip	Suture Size	Length (in.)
FM520	ST	7/0 AND SMALLER	4 3/4
R	R	7/0 AND SMALLER	6 1/4
FM521	ST	7/0 AND SMALLER	7 1/4
R	R	7/0 AND SMALLER	8 1/4
FM563	ST	7/0 AND SMALLER	9
R	R	5/0 AND SMALLER	5 3/4
FM565	ST	5/0 AND SMALLER	6 1/4
R	R	5/0 AND SMALLER	7 1/4
FM567	ST	5/0 AND SMALLER	8 1/4
R	R	5/0 AND SMALLER	9
FM522	ST	SMALLER	



FM524R-FM533R



FM524R-FM527R, FM532R



FM528R-FM531R, FM533R

Dia Dust Micro Needle Holder, Round Handle W/O Catch

Catalog Number	Tip	Suture Size	Length (in.)
FM523	ST		
R	R		
FM524	ST	7/0 AND SMALLER	4 3/4
FM564	ST	7/0 AND SMALLER	6 1/4
R	R	7/0 AND SMALLER	7 1/4
FM525	ST	7/0 AND SMALLER	7 1/4
FM566	ST	7/0 AND SMALLER	8 1/4
R	R	7/0 AND SMALLER	9
FM526	ST	7/0 AND SMALLER	9
FM568	ST	5/0 AND SMALLER	5 3/4
R	R	5/0 AND SMALLER	6 1/4
FM527	ST	5/0 AND SMALLER	6 1/4
R	R	5/0 AND SMALLER	7 1/4
FM532	ST	5/0 AND SMALLER	8 1/4
R	R	5/0 AND SMALLER	9
FM528	ST	SMALLER	



FM236R



1/2

Dia Dust Micro Needle Holder, Round Handle W/ Catch

Catalog Number	Tip	Suture Size	Length (in.)
FM529	ST		
R	R		
FM236R	STR	5/0 AND SMALLER	8 1/4
FM530	ST		

R R



FM276R 1/2



FM276R

Catalog Number	Tip	Suture Size	Length (in.)
FM276R	STR	5/0 AND SMALLER	8 1/4



FM534R-FM539R



FM534R-FM539R

Catalog Number	Tip	Description	Length (in.)
FM538R	STR	2/0 AND SMALLER	7 1/2
FM539R	STR	2/0 AND SMALLER	9
FM534R	STR	2/0 AND SMALLER	9 3/4



FM535R-FM537R



FM535R-FM537R

Catalog Number	Tip	Suture Size	Length (in.)
FM535R	STR	2/0 AND SMALLER	7 1/2
FM536R	STR	2/0 AND SMALLER	9
FM537R	STR	2/0 AND SMALLER	9 3/4

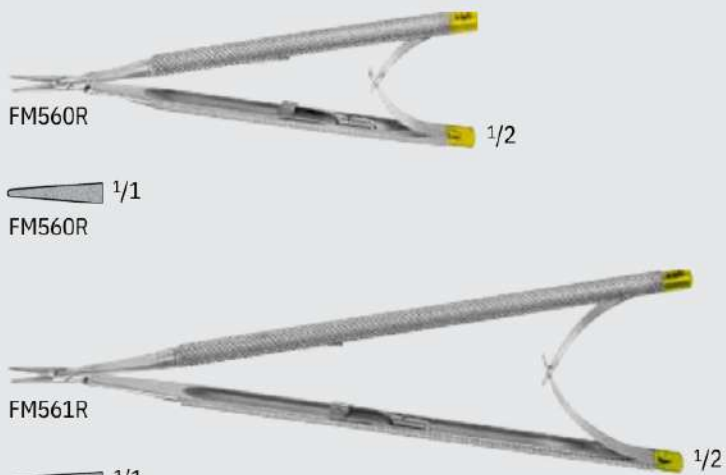

FM560R 1/2



FM560R

FM561R 1/2



FM561R

Catalog Number	Tip	Suture Size	Length (in.)
FM560R	STR	5/0 AND SMALLER	5
FM561R	STR	5/0 AND SMALLER	7



Cardiovascular

Titanium Micro Needle Holders

Aesculap Titanium Micro Instruments

■ The extremely light Titanium material is an advantage for

lengthy cardiac and vascular operations. This helps to carry on operating over longer time periods with minimum fatigue.

■ The non-magnetic material makes working with particularly fine needles easier for you.

■ Non-reflecting surface finish.

■ Incomparable operating sensitivity: the Aesculap golf ball handle design.

■ Unmistakable identification: the Aesculap color code.

For more information about Titanium Micro Instruments see our brochure number DOC890.



All needle holder jaws are coated with Aesculap Dia Dust™ diamond dust coating. This coating ensures that the inner surfaces provide the best possible performance in hardness and wear resistance. The texture of the jaws greatly increases its surface area, allowing you to grasp fine needles, sutures and soft tissue safely and securely. The needle quickly aligns itself in an ideal position in the rough surface. This results in a perfect grip that quite simply prevents any needle slippage.



FM238T-FM260T



FM258T-FM260T



FM238T-FM240T

Titanium Micro Needle Holder, Golf Ball Handle Design W/ Catch

Catalog Number	Tip	Suture Size	Handle Color	Length (in.)
FM258T	STR	7/0 AND SMALLER	GREEN	7 1/4
FM259T	STR	7/0 AND SMALLER	GREEN	8 1/4
FM260T	STR	7/0 AND SMALLER	GREEN	9
FM238T	STR	5/0 AND SMALLER	BLUE	7 1/4
FM239T	STR	5/0 AND SMALLER	BLUE	8 1/4
FM240T	STR	5/0 AND SMALLER	BLUE	9

SMALLER



FM232T-FM254T



FM252T-FM254T



FM232T-FM234T

Titanium Micro Needle Holder, Golf Ball Handle Design W/O Catch

Catalog Number	Tip	Suture Size	Handle Color	Length (in.)
FM252T	STR	7/0 AND SMALLER	GREEN	7 1/4
FM253T	STR	7/0 AND SMALLER	GREEN	8 1/4
FM254T	STR	7/0 AND SMALLER	GREEN	9
FM232T	STR	5/0 AND SMALLER	BLUE	7 1/4
FM233T	STR	5/0 AND SMALLER	BLUE	8 1/4
FM234T	STR	5/0 AND SMALLER	BLUE	9

SMALLER

VASCULAR



Dia Dust RYDER Needle Holder

Catalog Numbe	Tip	Suture Size	Length (in.)
BM301R	X-DEL	5/0 AND SMALLER	5 1/2
BM302R	X-DEL	5/0 AND SMALLER	7
BM325R	X-DEL	5/0 AND SMALLER	6 1/4
BM327R	X-DEL	5/0 AND SMALLER	8 3/4
BM328R	X-DEL	5/0 AND SMALLER	9 3/4

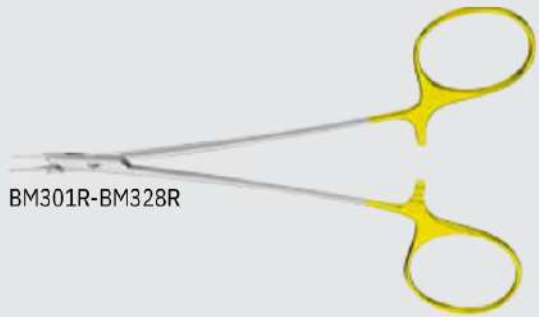

Titanium Dia Dust RYDER Needle Holder

Catalog Numbe	Tip	Suture Size	Length (in.)
BM385T	X-DEL	5/0 AND SMALLER	6 1/4
BM386T	X-DEL	5/0 AND SMALLER	7
BM387T	X-DEL	5/0 AND SMALLER	8 1/4

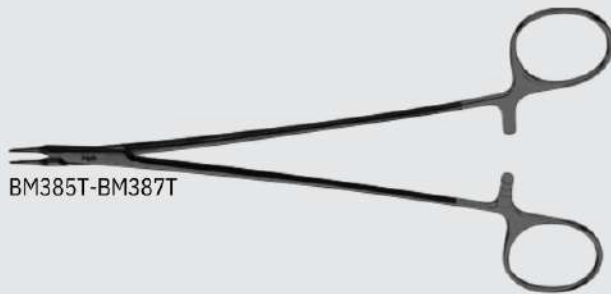

DUROGRIP TC DEBAKEY Needle Holder, O set

Catalog Number	Jaw	Length (in.)
BM051R	SER	7 3/4
BM052R	R	9 5/8

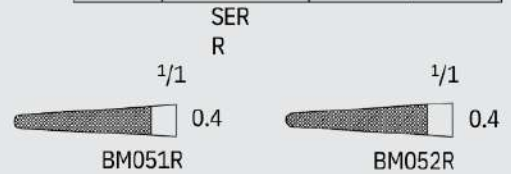

DUROGRIP TC Microvascular Needle Holder

Catalog Number	Jaw	Length (in.)
MG071R	SERR	6

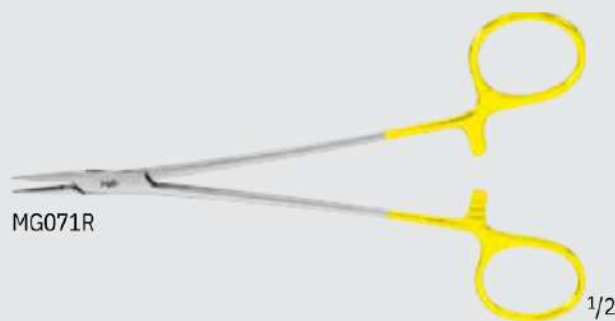

Cardiovascular

DUROGRIP™ TC Needle Holders



BM032R

1/1 0.4

BM033R

BM034R

BM035R-BM038R

BM035R

BM036R

BM037R

BM038R

BM040R

1/1 0.4

DUROGRIP TC DEBAKEY Needle Holder

Catalog Number	Tip	Jaw	Length (in.)
BM032R	DEL	SER	6
BM033R	DEL	R	6 1/2
BM035R	DEL	SER	7
BM034R	DEL	R	8 1/4
BM036R	DEL	SER	9
BM037R	DEL	R	10 1/4
BM038R	DEL	SER	12
BM063R	X-DEL	R	6 1/2
BM064R	X-DEL	SER	8 1/4
BM040R	X-DEL	R	12

SER
R
SER
R
SER
R
SER
R
SER
R

1/1 0.2

1/1 0.2

DUROGRIP TC RYDER Needle Holder

Catalog Number	Tip	Jaw	Length (in.)
BM054R	X-DEL	SERR	5 1/4
BM055R	X-DEL	SERR	6 1/8
BM056R	X-DEL	SERR	6 7/8
BM057R	X-DEL	SERR	8 1/4
BM058R	X-DEL	SERR	9
BM044R	DEL	SERR	5 1/4
BM045R	DEL	SERR	6 7/8
BM046R	DEL	SERR	7 3/4
BM047R	DEL	SERR	10 1/2
BM074R	DEL	SMOOTH	6
BM075R	DEL	SMOOTH	7
BM076R	DEL	SMOOTH	8 7/8

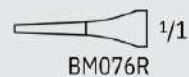
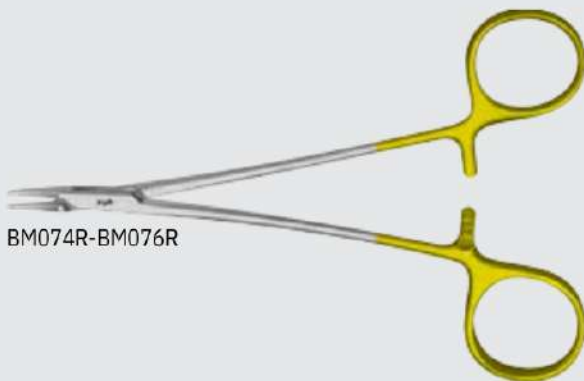
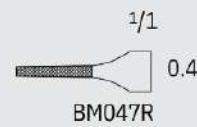
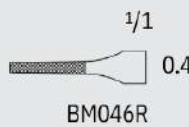
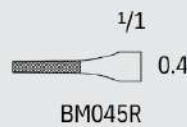
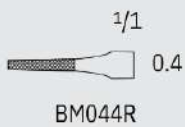
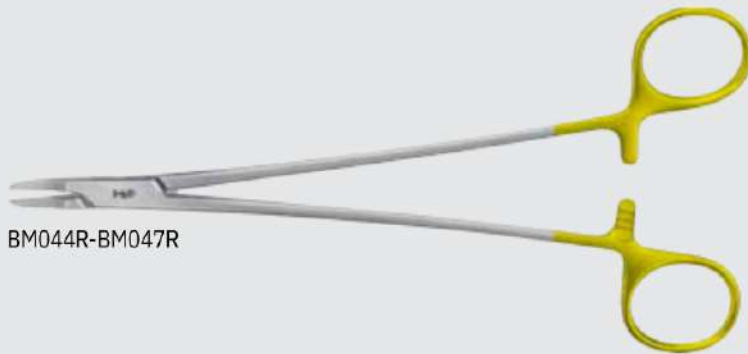
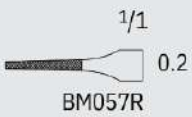
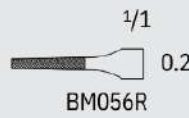

Cardiovascular

DUROGRIP™ TC Needle Holders



BM095R-BM096R

1/1 0.5
BM095R

1/1 0.5
BM096R

DUROGRIP TC STRATTE Needle Holder

Catalog Number	Tip	Jaw	Length (in.)
BM095R	CV	SER	8 1/4
BM096R	D	R	9
	CV	SER	
	D	R	

MB210R

1/1 1/2
MB210R

DUROGRIP TC COOLEY Intracardiac Needle Holder

Catalog Number	Jaw	Length (in.)
MB210R	SERR	9

DEBAKEY Tissue Forceps

Catalog Number	Tip Size (mm)	Length (in.)
MB062R	2	1
MB915R	2	4
MB916R	3	1



WHEELER Vessel Forceps

Catalog Number	Tip	Length (in.)
MG440R	SERR	6

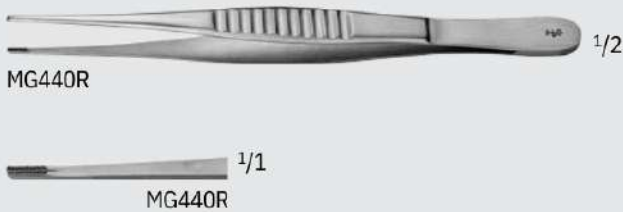

GERALD Dressing Forceps, Delicate

Catalog Number	Tip	Jaw	Length (in.)
BD228	STR	SER	6 7/8
R	STR	R	9
BD230	CVD	SER	6 7/8

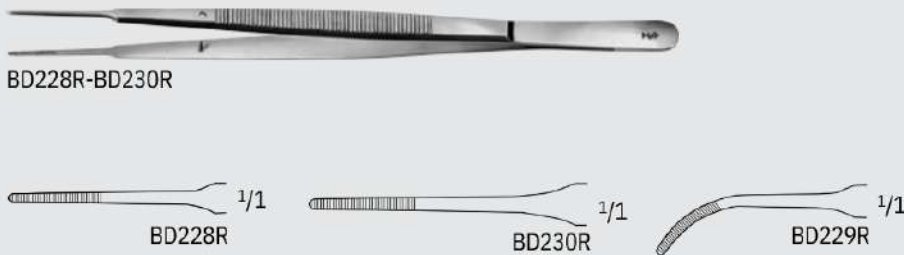

GERALD Tissue Forceps, Delicate

Catalog Number	Tip	Teeth	Length (in.)
BD662	STR	1 x 2	6 7/8
R	STR	1 x 2	9
BD664	CVD	1 x 2	6 7/8

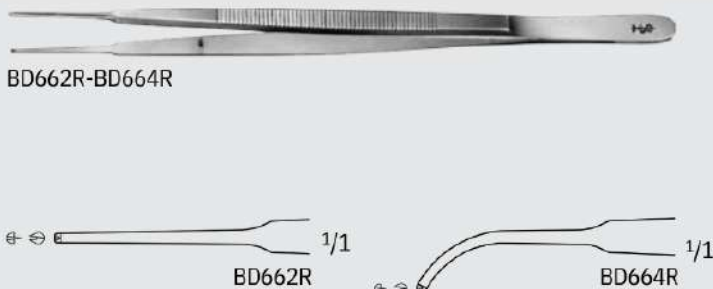

SELMAN Tissue Forceps

Catalog Number	Length (in.)
BD750R	6 1/8
MB795R	7 7/8
MG078R	9 3/4

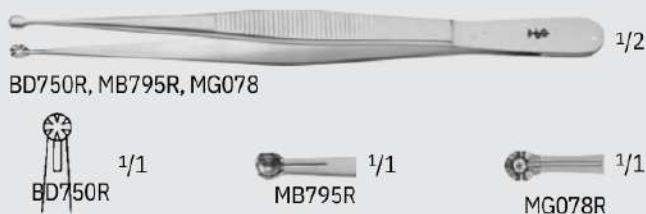

Cardiovascular

Forceps

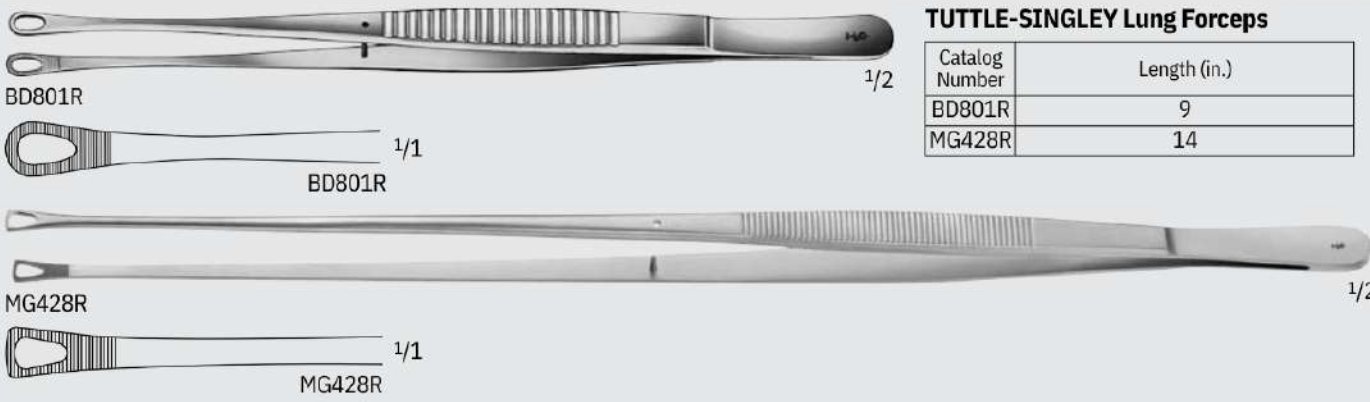
TUTTLE-SINGLEY Lung Forceps

Catalog Number	Length (in.)
BD801R	9
MG428R	14

BD801R 1/2
BD801R 1/1
MG428R 1/2
MG428R 1/1



NELSON Lung Forceps

Catalog Number	Length (in.)
BD802R	9

BD802R 1/2
BD802R 1/1
BD802R 1/1



RESANO Cardiac Valve Forceps

Catalog Number	Tip Size (mm)	Length (in.)
BD710	2.	7
R	5	8
BD711	2.	9
R	5	
BD712	2.	
R	5	

BD710R-BD712R
BD710R 1/1
BD711R 1/1
BD712R 1/1

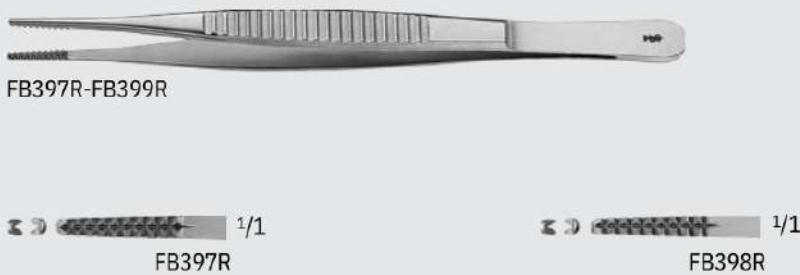

RESANO Cardiac Valve Forceps

Catalog Number	Tip Size (mm)	Length (in.)
FB397	2	7
R	2	9
FB398	2	11 3/4
R		
FB399		
R		

FB397R-FB399R
FB397R 1/1
FB398R 1/1
FB399R 1/1

GERALD Micro Forceps, Flat Handle

Catalog Number	Tip	Length (in.)
BD190R	SERR	7
BD197R	SERR	9 3/4



BD190R-BD197R



BD190R-BD197R

GERALD Micro Forceps, Flat Handle

Catalog Number	Tip	Length (in.)
BD191R	DEBAKEY	7
BD195R	DEBAKEY	7 7/8



BD191R-BD195R

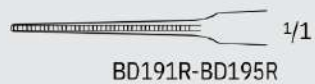

BD191R-BD195R

Micro Suture Forceps, W/ Platform

Catalog Number	Tip Size (mm)	Length (in.)
BD338R	0.3	4 3/4
BD264R	0.5	7 1/4



BD338R



BD338R



BD264R



BD264R

MUELLER Micro Forceps, Plastic Handle

Catalog Number	Teeth	Length (in.)
FM033R	-	6 1/4
FM034R	1 x 2	6 1/4



FM033R



FM033R



FM034R



FM034R



Cardiovascular

Forceps



FM035R



1/1
FM035R

MUELLER Micro Ring Forceps, Plastic Handle

Catalog Number	Diam. of Ring (mm)	Length (in.)
FM035R	1.2	6 1/4



FM036R



1/1
FM036R

MUELLER Micro Forceps, Plastic Handle, W/ Platform

Catalog Number	Length (in.)
FM036R	6 1/4



FM063R



1/1
FM063R

Micro Forceps, Round Handle

Catalog Number	Tip	Counter-balance	Length (in.)
FM063R	CROSS-SERR	NO	7 7/8



FM590R-FM591R



1/1
FM590R



1/1
FM591R

Micro Forceps, Round Handle

Catalog Number	Tip	Counter-balance	Length (in.)
FM590R	DEBAKEY	NO	7 1/4
FM591R	DEBAKEY	NO	8 1/4
FM592R	DEBAKEY	YES	7 1/4
FM600R	DEBAKEY	YES	8 1/4



FM592R-FM600R



1/1
FM592R



1/1
FM600R



BD154R



1/1
BD154R

DUROGRIP TC (POTTS-SMITH) Thumb Forceps

Catalog Number	Tip Number	Length (in.)
BD154R	X-SERR	5 3/4

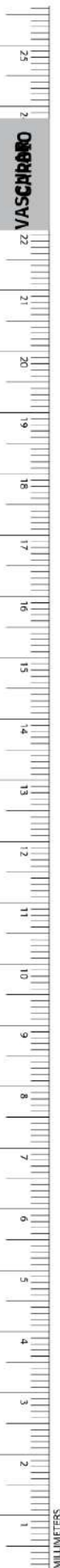



■ The Dia Dust diamond dust coating ensures an even harder and more wear resistant surface on the inside of the jaws. The structure of the Dia Dust coating enables a reliable grip for needles, sutures, and tissue.



BD192R-BD193R



BD192R

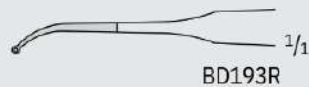

BD193R

Dia Dust GERALD Micro Ring Forceps, Flat Handle

Catalog Number	Diam. of Ring (mm)	Tip	Length (in.)
BD192R	1.	STR	7
BD193R	0	CVD	7
	1.		
	0		



BD194R-BD196R

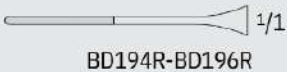

BD194R-BD196R

Dia Dust GERALD Micro Forceps, Flat Handle

Catalog Number	Tip	Tip Size (mm)	Length (in.)
BD194R	ST	1.	7
BD196R	R	0	7 7/8
	ST	1.	
	R	0	



BD200R-BD201R



BD200R-BD201R

Dia Dust THUMB Forceps, Flat Handle

Catalog Number	Tip	Tip Size (mm)	Length (in.)
BD200R	ST	1.	7
BD201R	R	0	8 1/4
	ST	1.	
	R	0	



FD253R

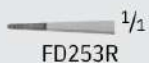

FD253R

Dia Dust Micro Forceps W/ Platform

Catalog Number	Tip	Counter-balance	Length (in.)
FD253R	STR	NO	7



Cardiovascular

Dia Dust™ Forceps



FM053R-FM054R



Dia Dust Micro Ring Forceps, Round Handle

Catalog Number	Diam. of Ring (mm)	Tip	Counter-balance	Length (in.)
FM053	2.	ST	NO	7
R	5	R	NO	7 7/8
FM054	2.	ST		
R	5	R		



FM597R-FM598R



FM587R



Dia Dust Micro Ring Forceps, Round Handle

Catalog Number	Diam. of Ring (mm)	Tip	Counter-balance	Length (in.)
FM597	1.	STR	NO	7 1/4
R	0	STR	NO	8 1/4
FM598	1.	CVD	NO	7 1/4
R	0			
FM587	1.			
R	0			



FM582R-FM584R



Dia Dust Micro Ring Forceps, W/ Platform, Round Handle

Catalog Number	Diam. of Ring (mm)	Tip	Counter-balance	Length (in.)
FM582	1.	ST	NO	7 1/4
R	0	R	NO	8 1/4
FM584	1.	ST		
R	0	R		



FM586R-FM588R



Dia Dust Micro Forceps, W/ Platform, Round Handle

Catalog Number	Tip	Counter-balance	Length (in.)
FM586	ST	NO	7 1/4
R	R	NO	8 1/4
FM588	ST		
R	R		



Dia Dust Micro Ring Forceps, Round Handle

Catalog Number	Diam. of Ring (mm)	Tip	Counter-balance	Length (in.)
FM570	1.	STR	YE	6
R	0	STR	S	7 1/4
FM572	1.	STR	YE	8 1/4
R	0	STR	S	9
FM574	1.	STR	YE	9 3/4
R	0	STR	S	7 1/4
FM576	1.	CVD	YE	6
R	0	CVD	S	7 1/4
FM596	1.	CVD	YE	8 1/4
R	0	CVD	S	9
FM579	2.	CVD	YE	9 3/4
R	0		S	
FM571	1.		YE	
R	0		S	
FM573	1.		YE	
R	0		S	
FM575	1.		YE	
R	0		S	
FM577	1.		YE	
R	0		S	
FM595	1.		YE	
R	0		S	

Dia Dust Micro Forceps, W/ Platform, Round Handle

Catalog Number	Tip	Counter-balance	Length (in.)
FM578	STR	YE	6
R	STR	S	7 1/4
FM580	STR	YE	8 1/4
R	STR	S	9 3/4
FM599	CVD	YE	6
R	CVD	S	7 1/4
FM594	CVD	YE	8 1/4
R	CVD	S	9 3/4
FM581		YE	
R		S	
FM583		YE	
R		S	
FM585		YE	
R		S	
FM593		YE	
R		S	



Cardiovascular

Titanium Forceps

Aesculap Titanium Micro Instruments

■ The extremely light Titanium material is an advantage for

lengthy cardiac and vascular operations. This helps to carry on operating over longer time periods with minimum fatigue.

■ Non-reflecting surface finish - for optimal glare reduction. ■ The Aesculap golf ball handle design - gives incomparable operating sensitivity.

■ The Aesculap color code - provides unmistakable instrument identification.

For more information about Titanium Micro Instruments see our brochure number **DOC890**.



All titanium forceps jaws are coated with Aesculap Dia Dust™ diamond dust coating. This coating ensures that the inner surfaces provide the best possible performance in hardness and wear resistance. The texture of the jaws greatly increases its surface area, allowing you to grasp sutures and soft tissue safely and securely.



FM317T-FM319T



FM317T-FM319T

Titanium Micro Ring Forceps, Golf Ball Handle

Catalog Number	Diam. of Ring (mm)	Tip	Handle Color	Counter-balance	Length (in.)
FM317T	1.0	DIA DUST	BLUE	NO	7 1/4
FM318T	1.0	DIA DUST	BLUE	NO	8 1/4
FM319T	1.0	DIA DUST	BLUE	NO	9



FM327T-FM329T



FM327T-FM329T

Titanium Micro Forceps, W/ Platform, Golf Ball Handle

Catalog Number	Tip	Handle Color	Counter-balance	Length (in.)
FM327T	DIA DUST	GREEN	NO	7 1/4
FM328T	DIA DUST	GREEN	NO	8 1/4
FM329T	DIA DUST	GREEN	NO	9



FM337T-FM339T



FM337T-FM339T

Titanium Micro Forceps, Golf Ball Handle

Catalog Number	Tip	Handle Color	Counter-balance	Length (in.)
FM337T	DEBAKEY	PURPLE	NO	7 1/4
FM338T	DEBAKEY	PURPLE	NO	8 1/4
FM339T	DEBAKEY	PURPLE	NO	9

Titanium Standard Forceps

- Non-reflecting surface finish.
 - Fatigue-free lightness.
 - Blue handle for definite identification of an Aesculap Titanium Instrument.
- For more information about Titanium forceps see our brochure number **DOC890**.



FB387T-FB389T



FB387T-FB389T 1/1



FB390T-FB392T



FB390T-FB392T 1/1

Titanium DEBAKEY Atraumatic Forceps

Catalog Number	Tip Size (mm)	Length (in.)
FB387T	1.	5 3/4
FB388T	5	7 3/4
FB389T	1.	9 1/2
FB390T	5	5 3/4
FB391T	1.	7 3/4
FB392T	5	9 1/2



BD221T 1/2



BD221T 1/1

Titanium Micro ADSON Dissecting Forceps

Catalog Number	Tip	Length (in.)
BD221T	SERR	4 3/4



BD514T 1/2



BD514T 1/1

Titanium Micro ADSON Tissue Forceps, Delicate

Catalog Number	Tip	Teeth	Length (in.)
BD514T	SERR	1 x 2	4 3/4



BD516T 1/2



BD516T 1/1

Titanium Micro ADSON Tissue Forceps

Catalog Number	Tip	Teeth	Length (in.)
BD516T	SERR	1 x 2	4 3/4



Cardiovascular

Titanium Forceps



Titanium GERALD Dissecting Forceps, Delicate

Catalog Number	Tip	Length (in.)
BD227T	SERR	6 3/4



Titanium GERALD Tissue Forceps

Catalog Number	Tip	Teeth	Length (in.)
BD657T	SERR	1 x 2	6 3/4



Titanium RESANO Grasping Forceps

Catalog Number	Tip	Length (in.)
BD715T	SERR	9

VASCARBO

Titanium Ringhandled Instruments

- Non-reflecting surface finish.
 - Fatigue-free lightness.
 - Blue rings for definite identification of an Aesculap Titanium Instrument.
- For more information about Titanium Ringhandled Instruments see our brochure number **DOC890**.

Titanium DEBAKEY Atraumatic Vascular Clamp

Catalog Number	Jaw	Jaw Length (mm)	Length (in.)
FC320T	STR	70	9

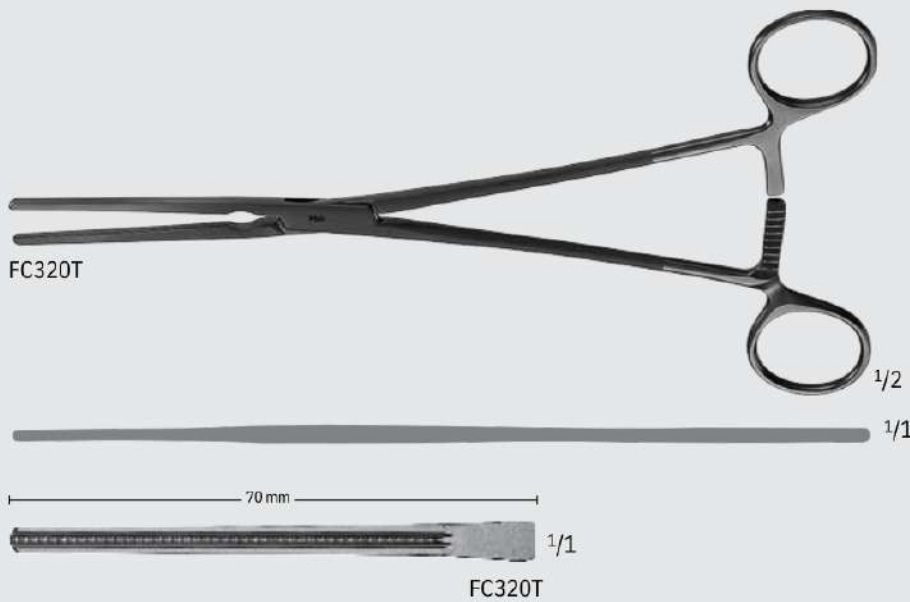

Titanium DEBAKEY Atraumatic Vascular Clamp

Catalog Number	Jaw	Jaw Length (mm)	Shaft	Length (in.)
FC321T	STR	60	ANG	8 1/2

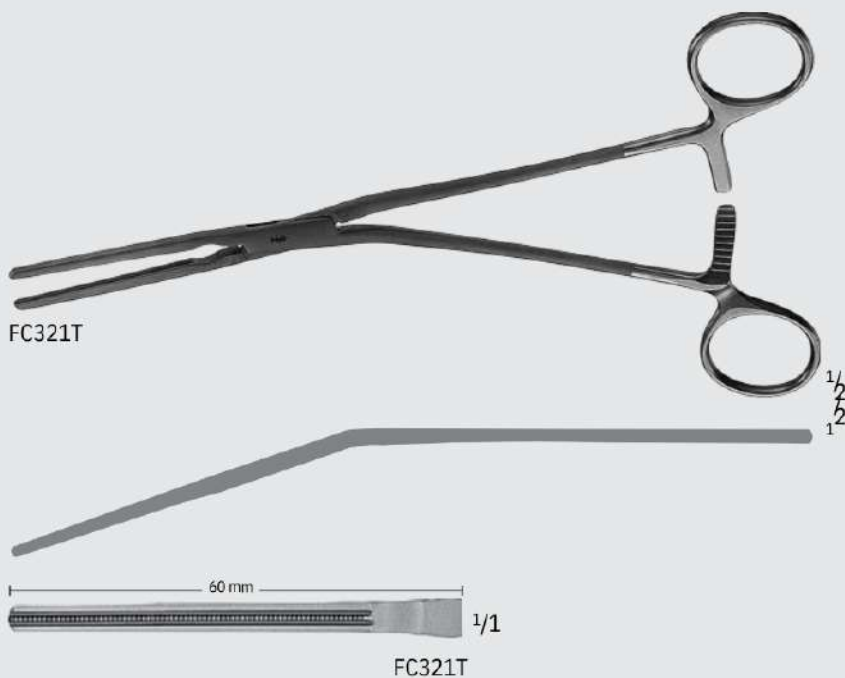

INCHES

Cardiovascular

Titanium Clamps



FC322T-FC323T

Titanium DEBAKEY Atraumatic Vascular Clamp

Catalog Number	Jaw	Jaw Length (mm)	Length (in.)
FC322	CV	7	8 7/8
T	D	0	9 5/8
FC323	CV	7	
T	D	5	

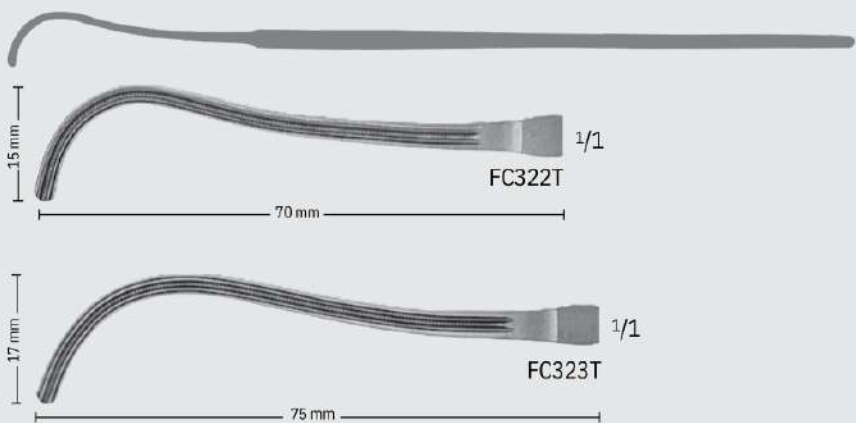

FC324T-FC325T

Titanium GLOVER Atraumatic Vascular Clamp

Catalog Number	Jaw	Jaw Length (mm)	Length (in.)
FC324	CV	6	8 3/4
T	D	0	10 5/8
FC325	CV	8	
T	D	0	

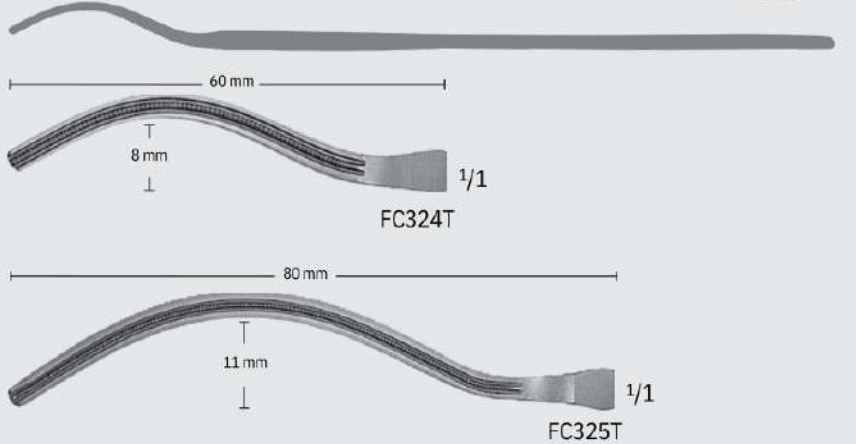

Titanium LAMBERT-KAY Atraumatic Vascular Clamp

Catalog Number	Jaw Angle	Jaw Length (mm)	Shaft	Length (in.)
FC326T	MULTI	45	ANG	7 3/4

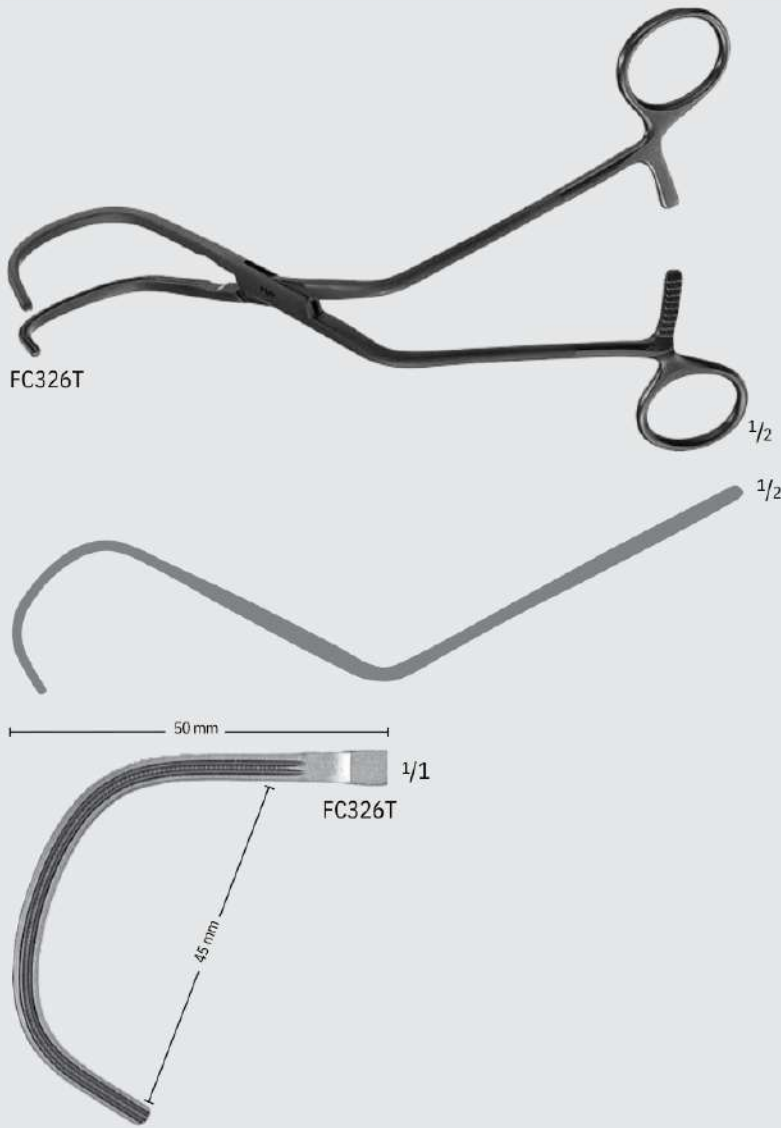

Cardiovascular

Titanium Clamps

Titanium DEBAKEY Atraumatic Vascular Clamp

Catalog Number	Jaw	Length (in.)
FC327	SLIGHT-CVD	12 1/4
T	SLIGHT-CVD	12 1/2

FC328
T

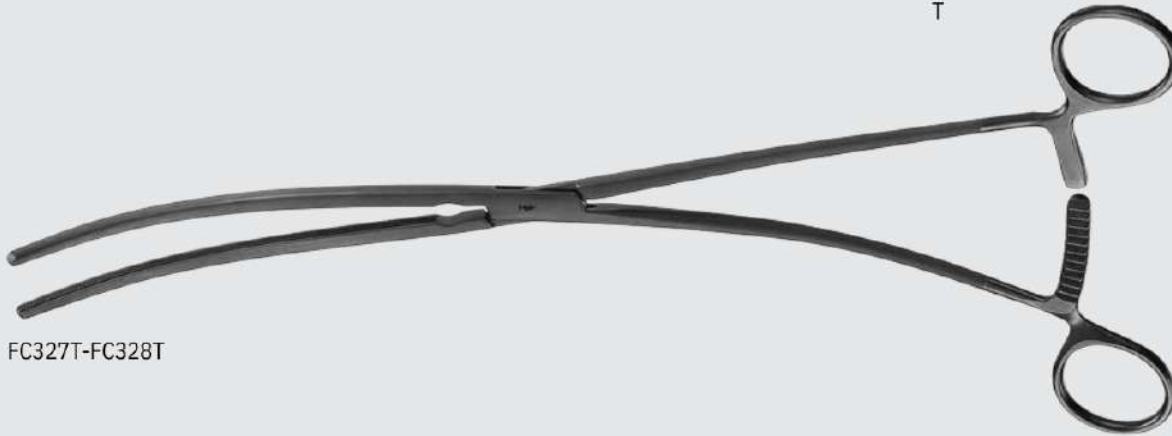

FC327T-FC328T



130 mm

30 mm

1/1

FC327T

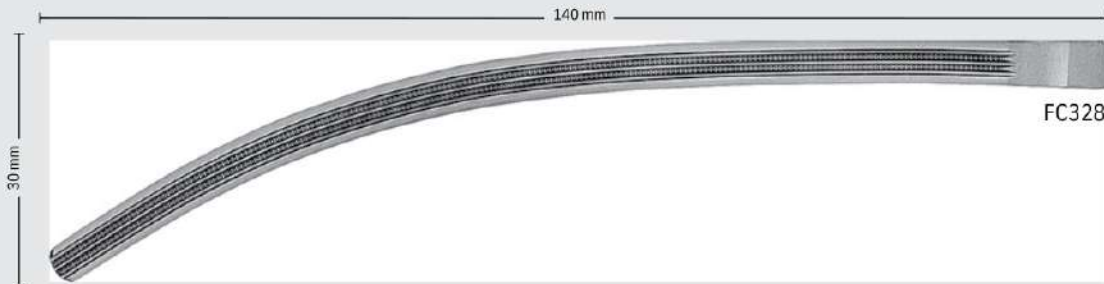

140 mm

30 mm

1/1

FC328T



Titanium DEBAKEY Atraumatic Vascular Clamp

Catalog Number	Jaw	Shaft	Length (in.)
FC331	CVD	ANG	7 3/4
T	ANG	ANG	7

FC330
T



FC330T-FC331T



65 mm

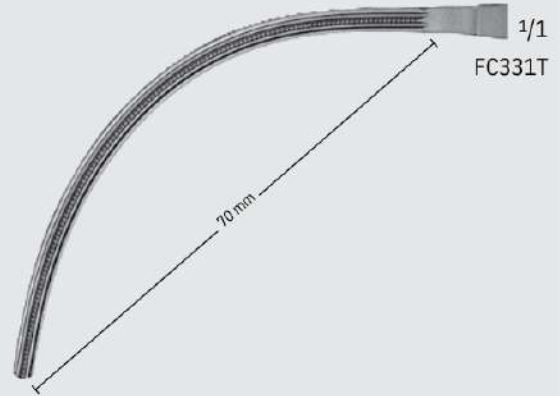

1/1
FC331T



55 mm

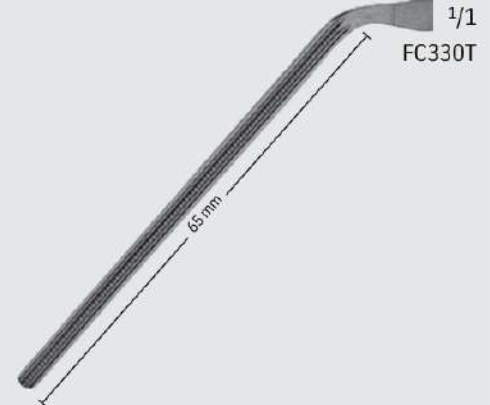

1/1
FC330T



INCHES

Cardiovascular

Titanium Clamps



VASCULAR

Titanium DEBAKEY Atraumatic Vascular Clamp

Catalog Number	Jaw	Length (in.)
FC329T	HEAVY-CVD	10 1/4



FC329T

1/2



1/2

60 mm

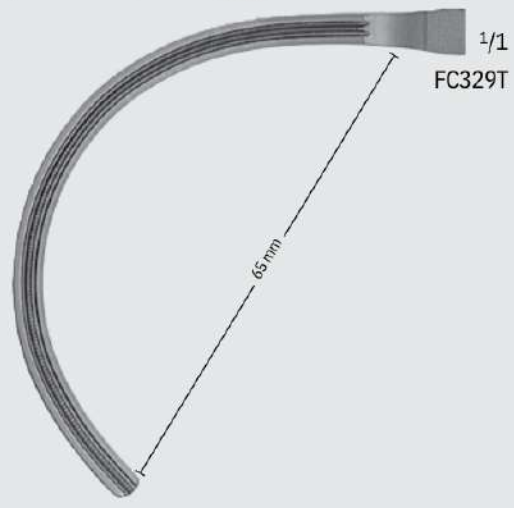

1/1
FC329T

65 mm

Titanium DEBAKEY Atraumatic Vascular Clamp

Catalog Number	Jaw	Shaft	Length (in.)
FC332	ANG	ANG	9 1/2
T	ANG	ANG	8 1/2

FC333
T



FC332T-FC333T

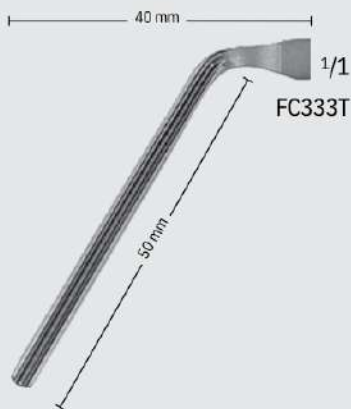

INCHES

Cardiovascular

Titanium Clamps



VASCULAR



FC334T-FC336T

Titanium DEBAKEY-SATINSKY Atraumatic Vascular Clamp

Catalog Number	Jaw Angle	Shaft	Length (in.)
FC336	MULT	ANG	7 7/8
T	I	ANG	9 5/8
FC335	MULT	ANG	9 3/4
T	I		
FC334	MULT		
T	I		

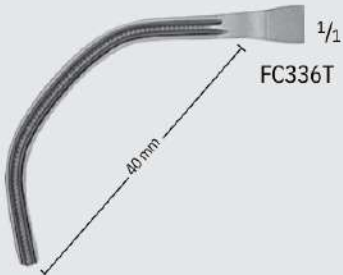

FC336T

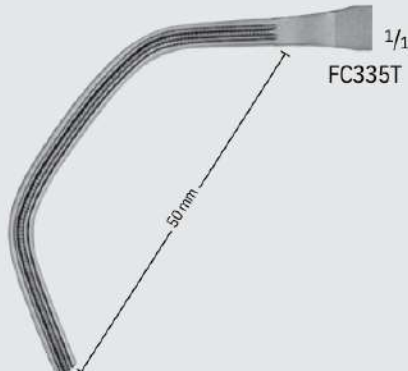

FC335T

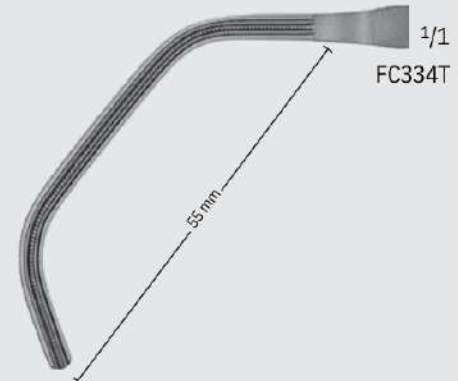

FC334T

Titanium DEBAKEY Atraumatic Pediatric Vascular Clamp

Catalog Number	Jaw Angle	Length (in.)
FC337	STR	4 1/4
T	30°	4 1/4
FC338	45°	4 1/4
T	60°	4 1/4
FC339	MULTI	3 3/4
T	MULTI	4
FC340	MULTI	4

T
FC341
T
FC342
T
FC343
T



FC337T-FC343T



30 mm
1/1
FC337T

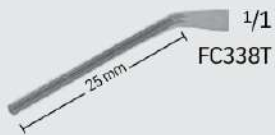

1/1
25 mm
FC338T

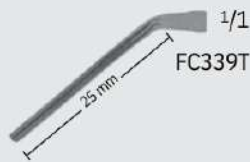

1/1
25 mm
FC339T

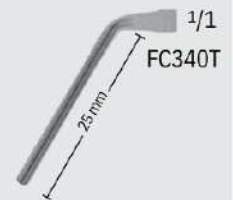

1/1
25 mm
FC340T



1/1
6 mm
10 mm
FC341T



1/1
6 mm
10 mm
FC342T



1/1
6 mm
12 mm
FC343T



Cardiovascular

Forceps and Clamps

Chest Tube Passer

Catalog Number	Description	Length (in.)
MG578R	W/O RATCHET	9 3/4
MG589R	W/O RATCHET	14
MG588R	W/ RATCHET	9 3/4



MG578R, MG589R



MG578R, MG589R



MG588R



MG588R





Tubing Clamp

Catalog Number	Jaw	Length (in.)
AN909R	SMOOTH	6 1/2
MD452R	SERR	6
MD453R	SERR	7
MD454R	SERR	7 7/8

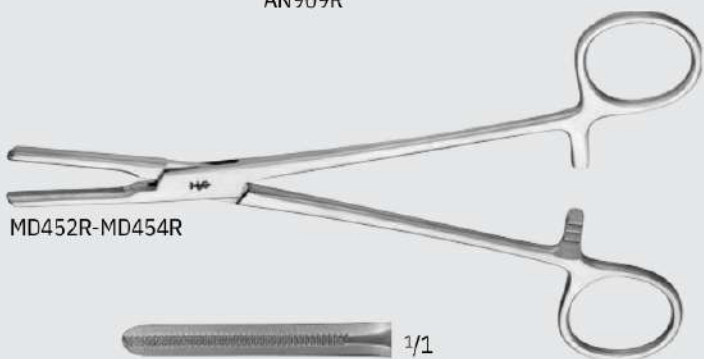

Tubing Clamp, W/ Guard

Catalog Numbe	Jaw	Length (in.)
MD652	SER	6
MD653	R	7
MD654	SER	7 7/8
	R	
	SER	
	R	



Cardiovascular

Forceps and Clamps



SAROT Forceps, Delicate

Catalog Number	Teeth	Length (in.)
BH224R		9 1/2
BH234R	1 x 2	9 1/2



CRAFOORD Forceps, Delicate

Catalog Number	Jaw	Length (in.)
BH225R	CVD	9 5/8

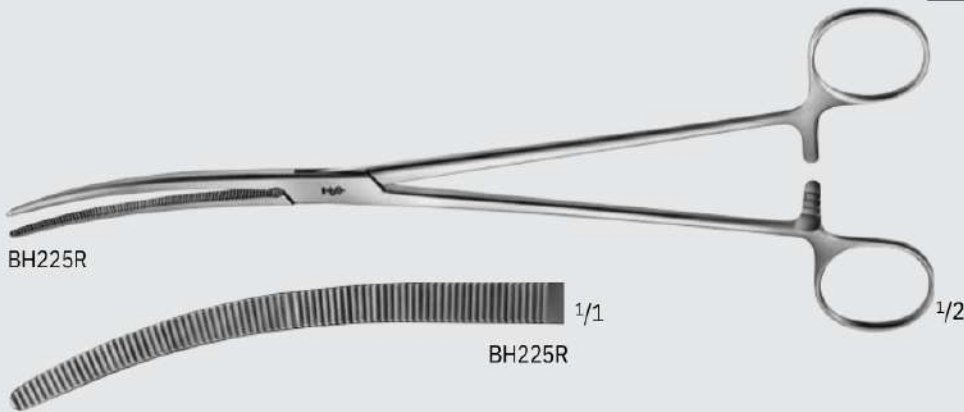

HOLLE Forceps, Delicate

Catalog Number	Jaw	Length (in.)
BJ037R	CVD	5 3/4
BJ038R	CVD	7 1/4
BJ039R	CVD	9 1/4

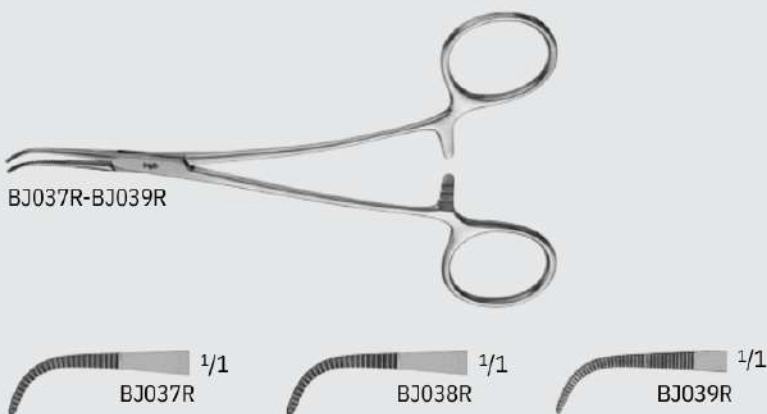

COLLER Artery Forceps

Catalog Number	Jaw Angle	Length (in.)
MG421R	90°	9 1/2

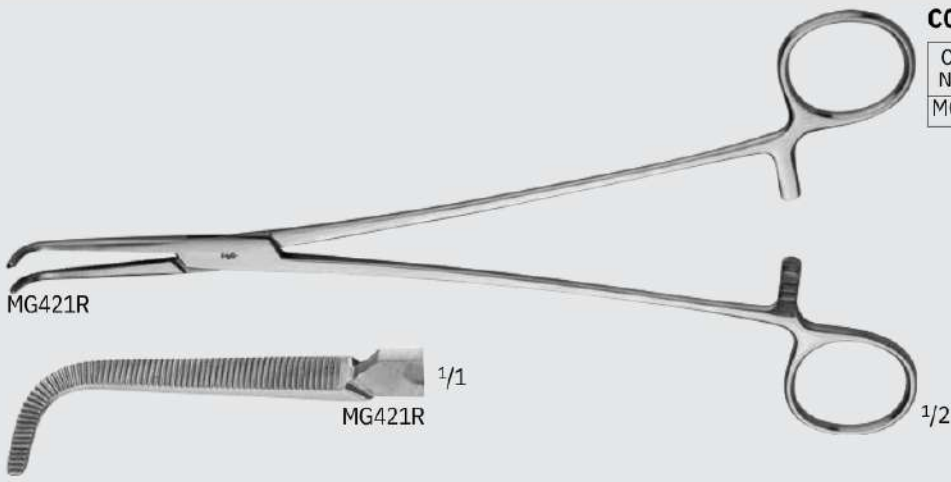

SAROT Intrathoracic Artery Forceps

Catalog Number	Jaw	Length (in.)
BH226R	SLIGHT-CVD	9 3/4

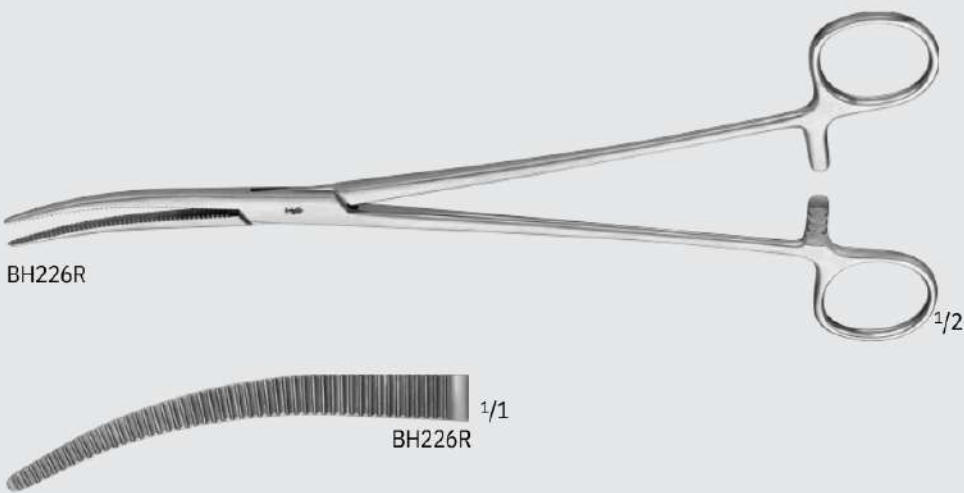

JULIAN Thoracic Artery Forceps

Catalog Number	Jaw	Length (in.)
BH233R	CVD	

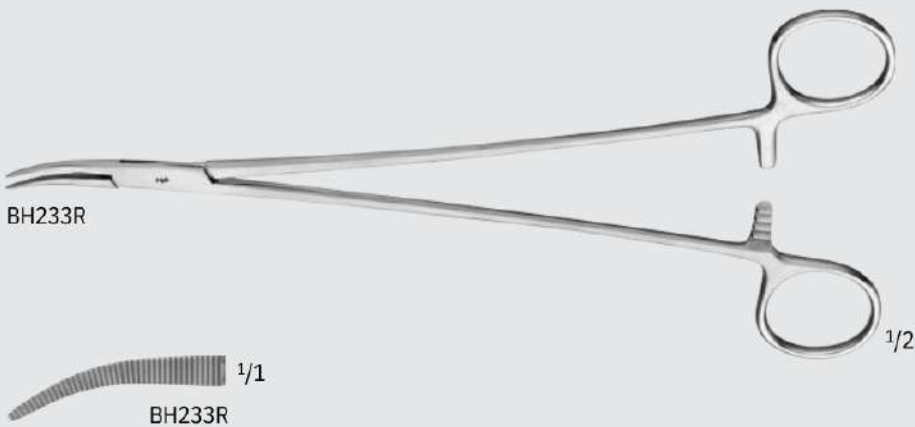

Cardiovascular

Forceps and Clamps



VASCULAR

LOVELACE Lung Forceps

Catalog Number	Length (in.)
MB056R	8

MB056R 1/2

MB056R 1/1

DUVAL Lung Forceps

Catalog Number	Length (in.)
FB930R	9

FB930R 1/2

FB930R 1/1

BABCOCK Thoracic Tissue Forceps

Catalog Number	Length (in.)
MB057R	9 1/2

MB057R 1/2

MB057R 1/1

Thoracoscopy Forceps

Catalog Number	Jaw	Jaw Length (mm)	Length (in.)
MB458R	STR, LONG	15	12
MB296R	CVD, LONG	8	1/2
		15	12
		8	1/4

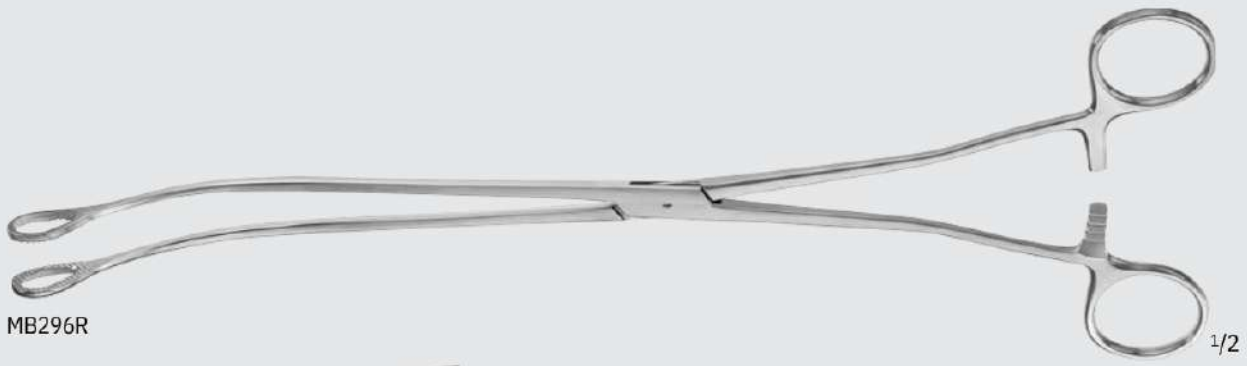
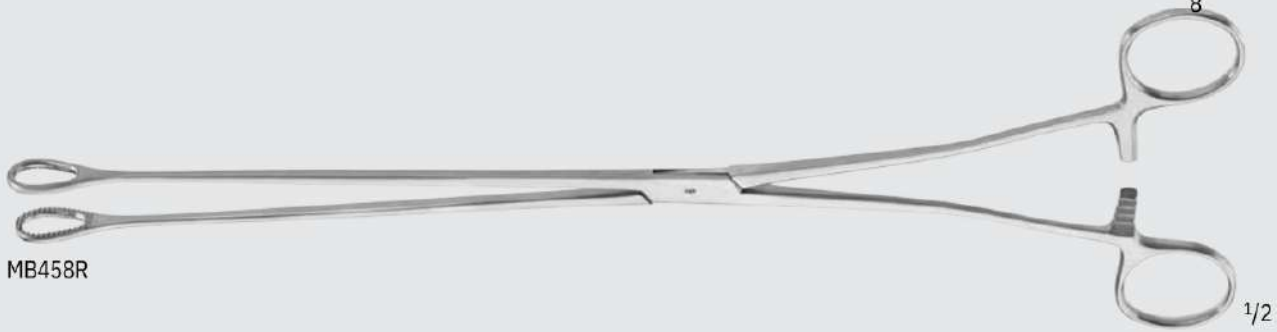

Cardiovascular

Forceps and Clamps

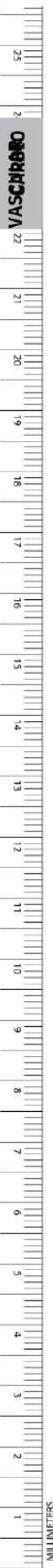

ROCHESTER-OCHSNER Artery Forceps

Catalog Number	Jaw	Teeth	Length (in.)
MB172R	STR	1 x 2	14

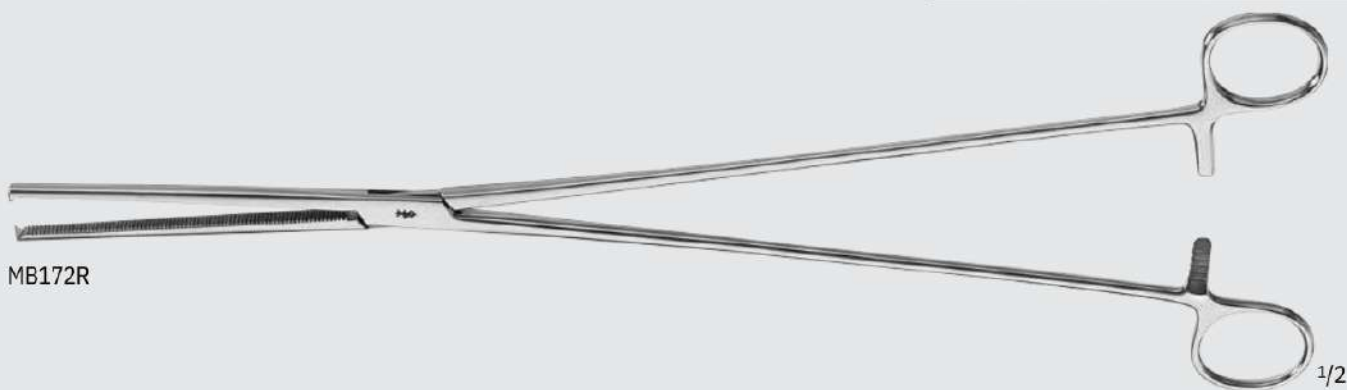

MB172R

MB172R

1/2

1/2

CARMALT Artery Forceps, Longitudinal Serrations

Catalog Number	Jaw	Length (in.)
MB182R	SLIGHT-CVD	12

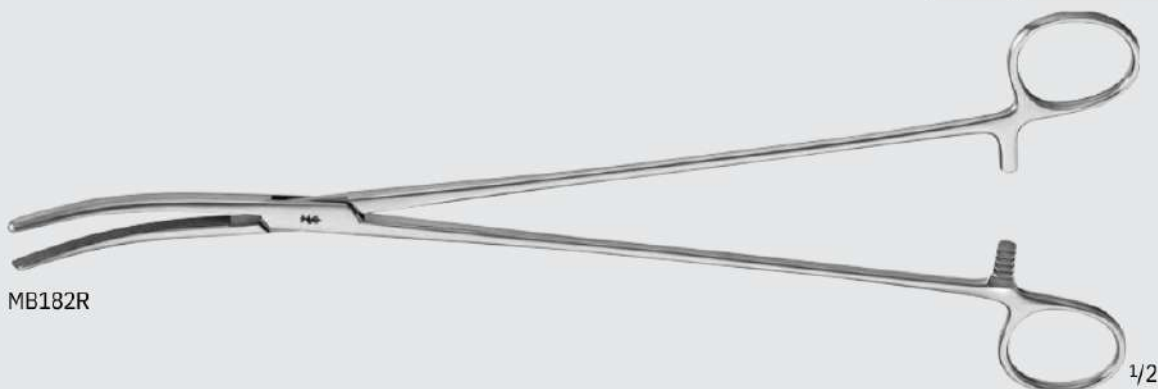

MB182R

MB182R

1/2

1/2

COOLEY Bronchus Clamp

Catalog Number	Jaw	Length (in.)
MG449R	ANG	8 1/4

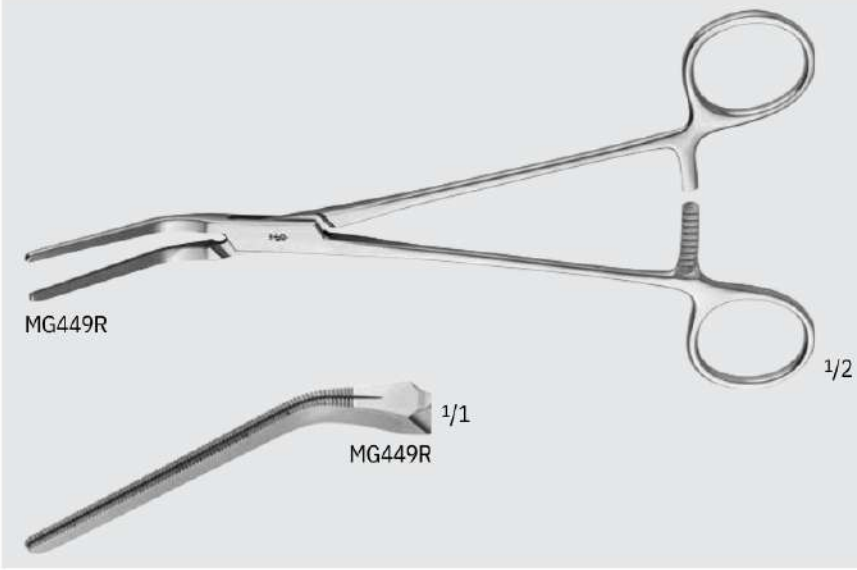

Bronchus Clamp, Longitudinal Serrations

Catalog Number	Jaw Angle	Jaw Length (mm)	Length (in.)
FB954	90	6	9
R	°	0	9
FB955	90	8	
R	°	0	

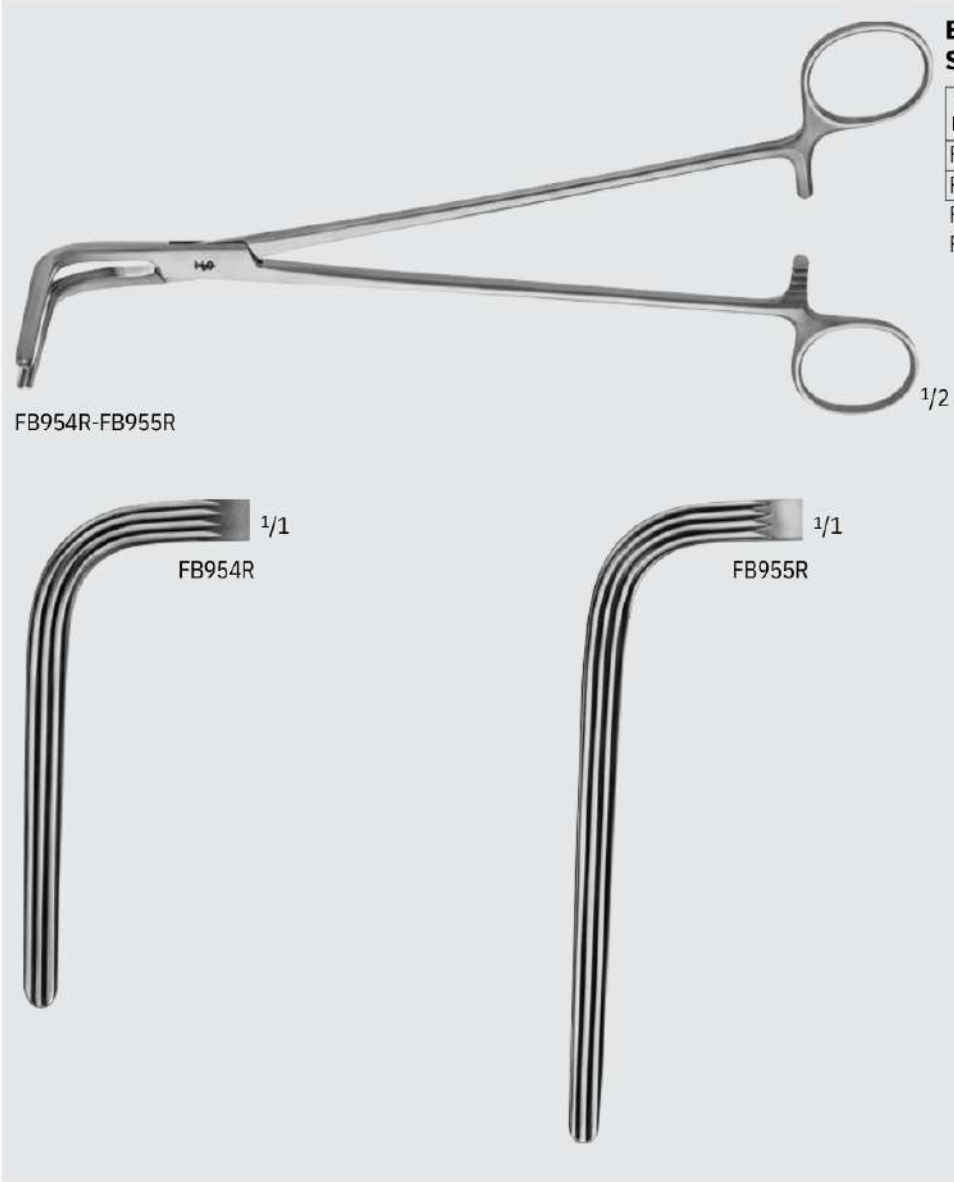

Cardiovascular

Forceps and Clamps



MB608R-MB610R

SAROT Bronchus Clamp

Catalog Number	Jaw	Length (in.)
MB610R	CVD-RIGHT	9
MB608R	CVD-LEFT	9

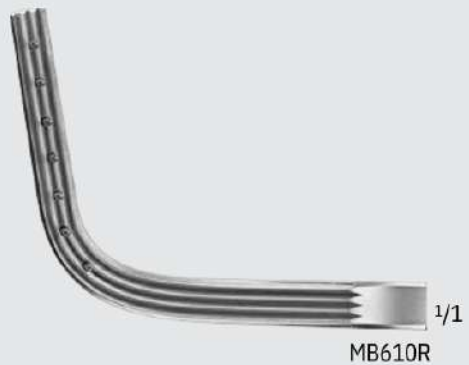

MB610R



MB608R



FOGARTY-Type Clamp

Catalog Number	Jaw	Jaw Length (mm)	Length (in.)
MB091R	STR	3	6 1/2
MB070R	STR	3	11 5/8
MB096R	STR	6	12 1/4
MB092R	ANG	1	4 5/8
MB094R	ANG	8	8 1/2
MB093R	ANG	6	8 3/4
MB095R	ANG	3	9 1/4



MB070R, MB091R-MB096R



MB092R



MB093R



MB094R

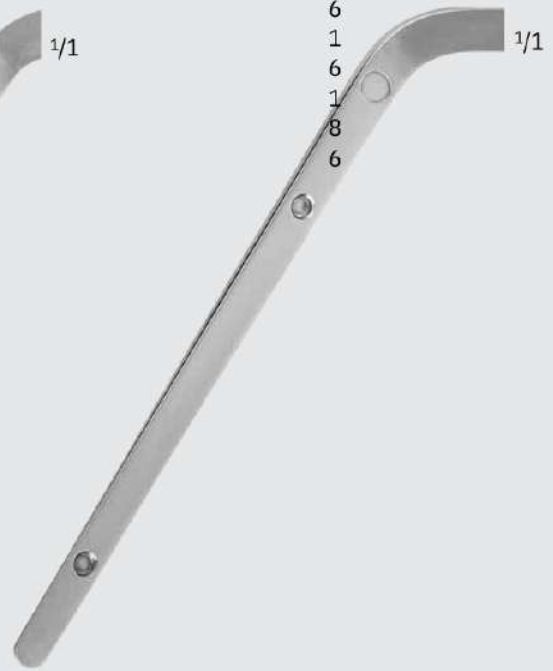

MB095R



MB091R



MB070R



MB096R

FOGARTY-Type Spring Clip Applicator

Catalog Number	Teeth	Length (in.)
MB097R	1 x 2	7 1/4



MB097R



MB097R

Cardiovascular

Vascular Clamps

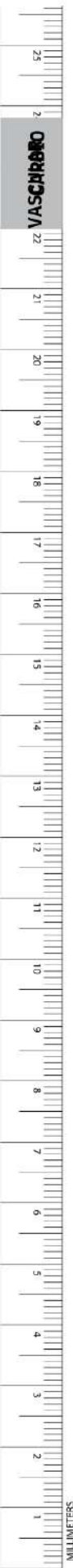

PRICE-THOMAS Bronchus Forceps

Catalog Number	Length (in.)
FB950R	8 7/8

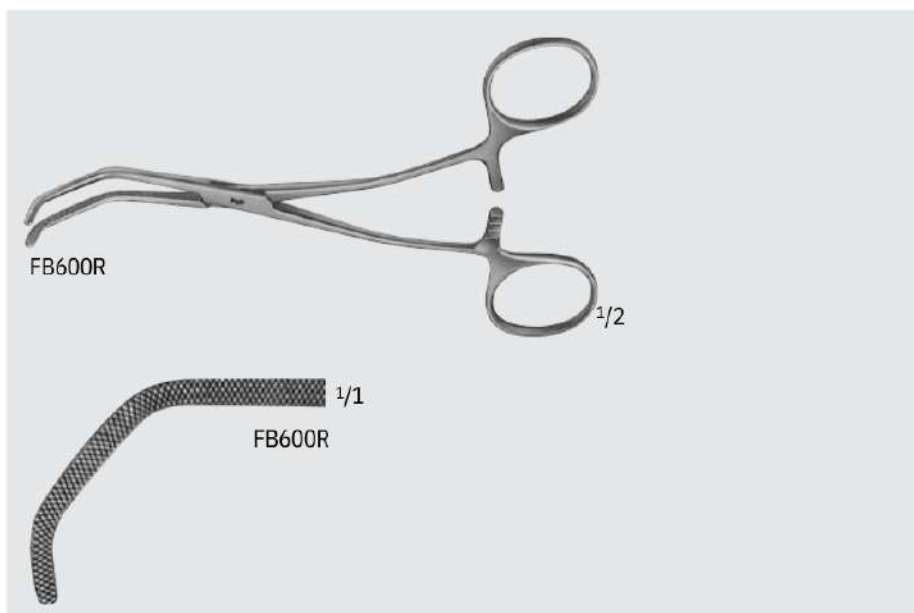

Baby SATINSKY Vena Cava Clamp

Catalog Number	Jaw	Length (in.)
FB600R	X-SERR	6

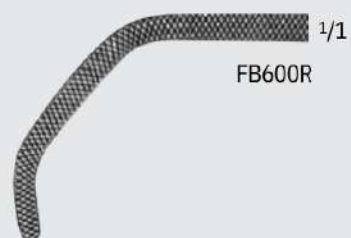

SATINSKY Vena Cava Clamp

Catalog Number	Jaw ANG	Jaw Size	Shaft	Length (in.)
FB602R	X-SERR			
FB604R	ANG,	LARGE	STR	10 1/2
FB605R	X-SERR	SMALL	LIGHT-CVD	10 1/2
	ANG,	LARGE	LIGHT-CVD	10 1/2



FB602R

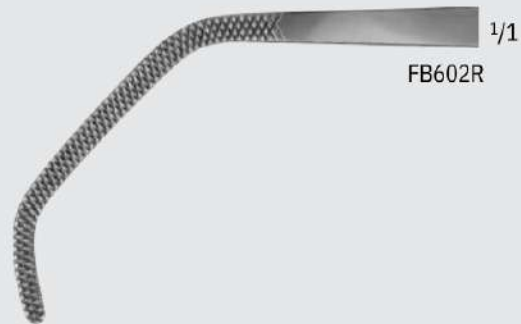

FB602R



FB604R-FB605R



FB604R

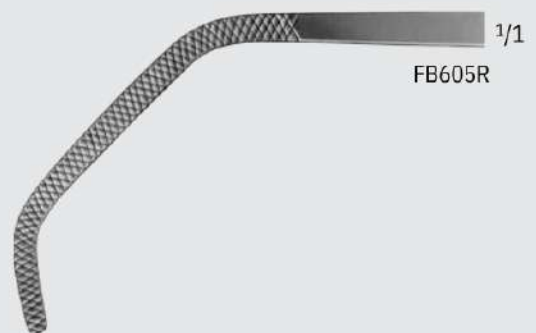

FB605R



INCHES

Cardiovascular

Vascular Clamps



CRAFOORD-SELLORS Coarctation Clamp, Longitudinal Serrations

Catalog Number	Jaw	Length (in.)
FB633R	SLIGHT-CVD	9 1/2

FB633R

1/2

1/1

FB633R

CRAFOORD Auricle Clamp, Longitudinal Serrations

Catalog Number	Jaw	Length (in.)
FB634	MEDIUM-CVD	9 1/2
R	HEAVY-CVD	9 1/2

FB634R-FB635R

1/2

1/1

FB634R

1/1

FB635R

SEMB Suture Forceps

Catalog Number	Jaw	Length (in.)
FB961R	HEAVY-CVD	9 1/2

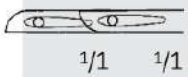

HALLMAN Tunnelling Forceps

Catalog Number	Jaw	Length (in.)
MG075R	SERR RING	13 1/2

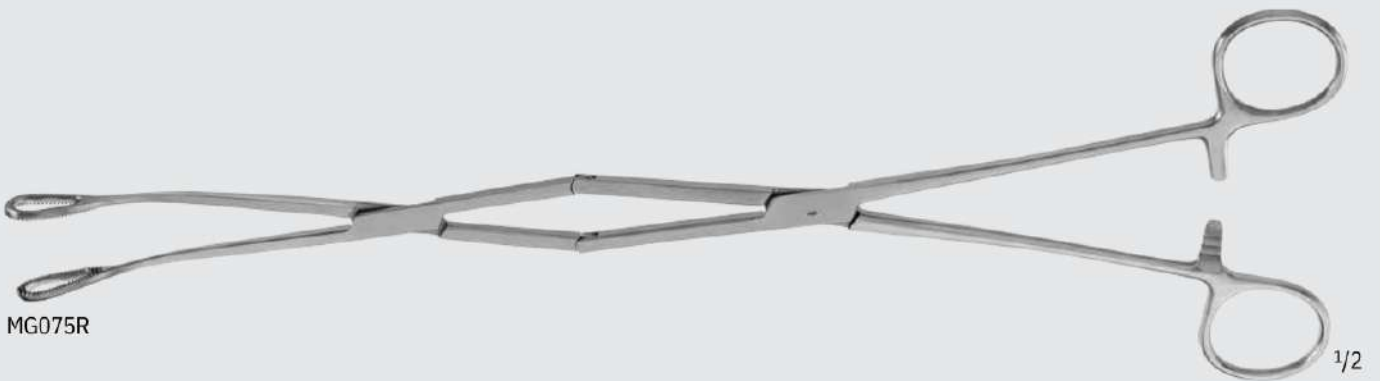

Cardiovascular

Vascular Clamps



FB440R-FB441R



FB440R



FB441R



FB442R-FB443R



FB442R



FB443R

DEBAKEY Mosquito Atraumatic Forceps

	Jaw Number	Jaw Length (mm)	Length (in.)
FB440	STR	2	5
R	STR	0	6 1/2
FB442	CVD	2	5
R	CVD	7	6 1/2
FB441		2	
R		0	
FB443		2	
R		7	



DEBAKEY-BAINBRIDGE Atraumatic Forceps

	Jaw	Catalog Number	Jaw Length (mm)	Length (in.)
FB446	STR		4	6 1/8
R	STR		0	7
FB448	CVD		6	6 1/8
R	CVD		5	7
FB447			4	
R			0	
FB449			6	
R			5	

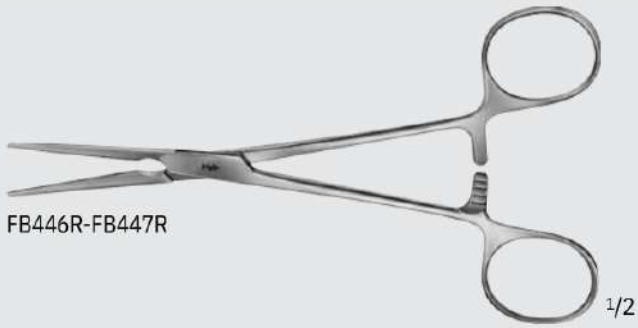

Cardiovascular

Vascular Clamps

DEBAKEY-HARKEN Atraumatic Vascular Clamps

Catalog Number	Tip Size (#)	Jaw	Jaw Length (mm)	Length (in.)
FB521R	1	CVD	86	10
FB522R	2	CVD	86	9 5/8
FB523R	3	CVD	86	9 5/8
FB524R	4	CVD	86	9 3/4

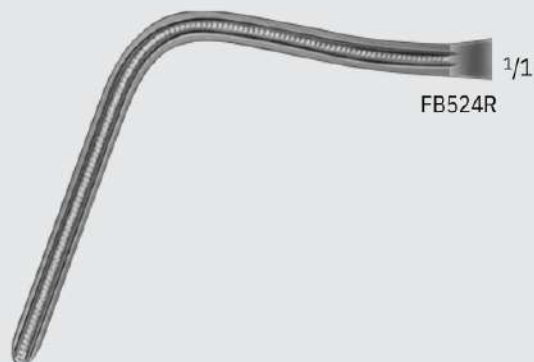
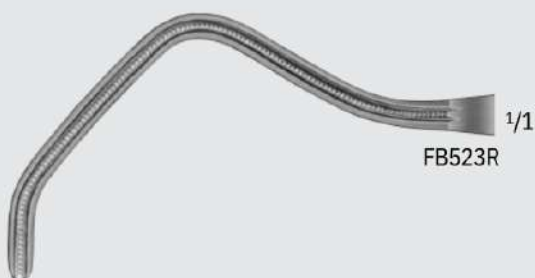
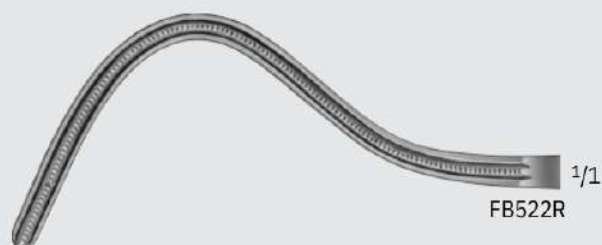

DEBAKEY-PEAN Atraumatic Forceps

Catalog Number	Jaw	Jaw Length (mm)	Length (in.)
FB526R	STR	60	7 7/8
FB532R	STR	89	10 1/2
FB534R	STR	99	11
FB527R	CVD	60	7 7/8
FB533R	CVD	89	10 1/4
FB535R	CVD	99	10 3/4



FB526R-FB535R



FB526R



FB532R



FB534R



FB527R



FB533R



FB535R



Cardiovascular

Vascular Clamps



FB540R-FB541R, FB543R-FB544R

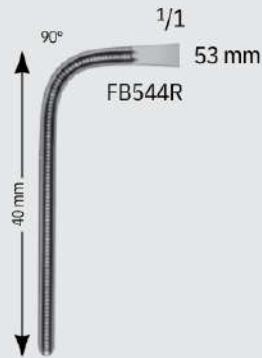
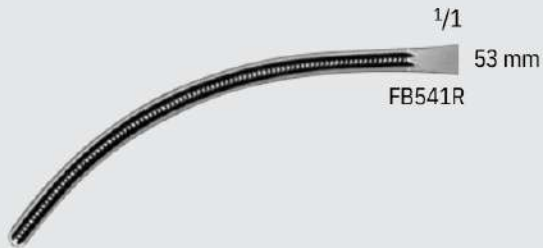
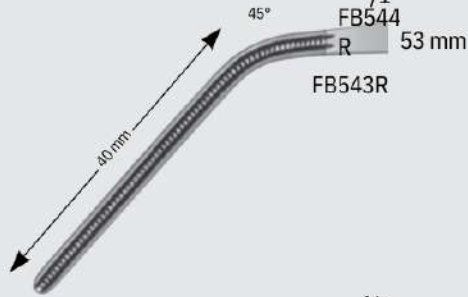

FB542R



DEBAKEY Atraumatic Ring Handle Bulldog Clamp

Catalog Number	Jaw Angle	Jaw Length (mm)	Length (in.)
FB540	STR	5	5 1/8
R	CVD	3	5
FB541	CVD*	5	5
R	45°	3	5
FB542	90°	5	4 1/8

* Instrument is S-Shaped
 FB543 3
 R 1/1 5
 FB544 3
 R 53 mm 5
 3

DEBAKEY Atraumatic Multi-Purpose Clamp, Curved

Catalog Number	Jaw Length (mm)	Length (in.)
FB557	31	6 1/2
R	40	6 3/4

FB558
R

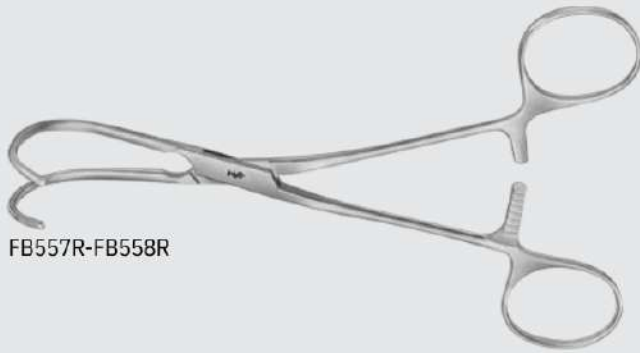

FB557R-FB558R

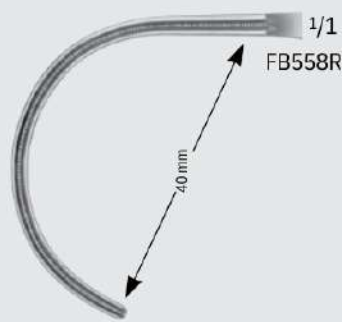
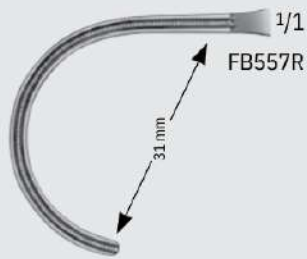

COOLEY Atraumatic Pediatric Vascular Clamp

Catalog Number	Jaw Angle	Jaw Length (mm)	Length (in.)
FB563R	MULTI	24	6 1/4

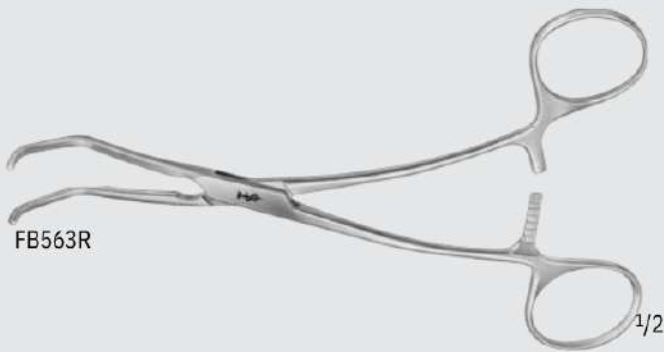

FB563R

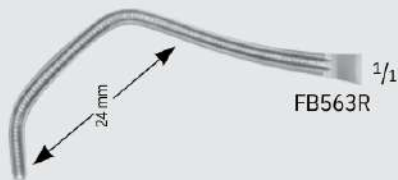

INCHES

Cardiovascular

Vascular Clamps



COOLEY Atraumatic Pediatric Vascular Clamp (continued)

Catalog Number	Jaw Length		Length (in.)
	Jaw Angle	(mm)	
FB741	25°	3	5 3/4
R	30°	8	6 1/2
FB567	60°	3	6 1/4
R	90°	0	6
FB568	MULTI	3	7 7/8
R		0	
FB569		3	
R		0	
FB570		9	
R		0	

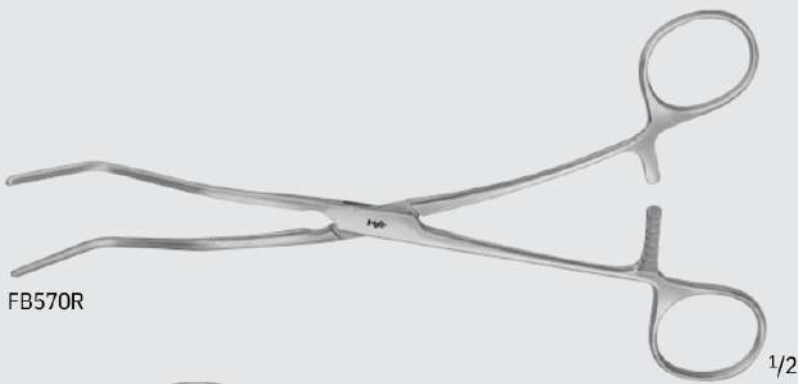
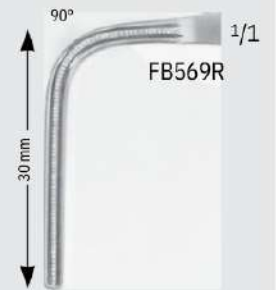
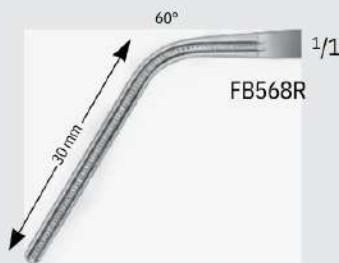
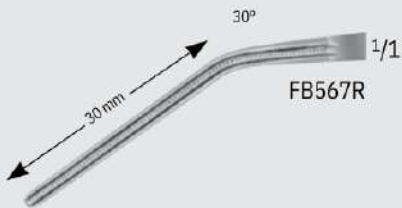
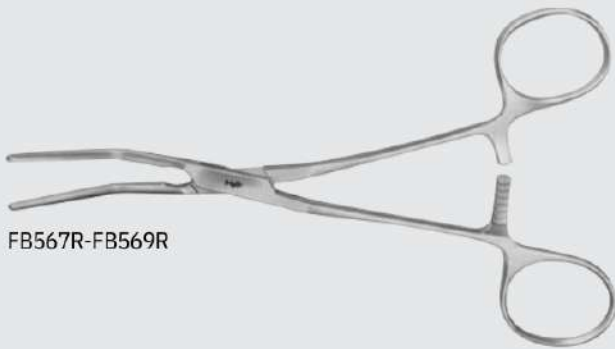

CASTANEDA Atraumatic Neonatal Clamp, Angled

Catalog Number	Jaw Angle	Jaw Length (mm)	Length (in.)
FB581	30	3	4 3/4
R	°	3	4 3/4
FB582	45	3	
R	°	1	

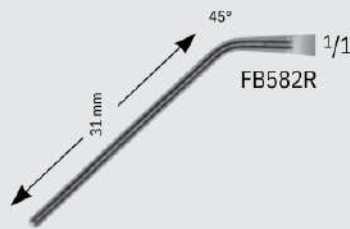
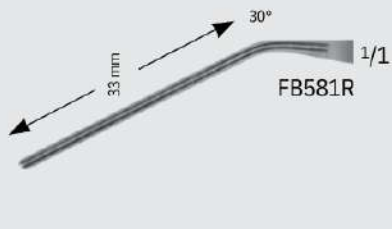
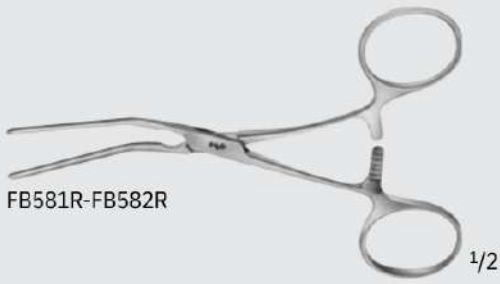

CASTANEDA Atraumatic Neonatal Clamp

Catalog Number	Jaw Angle	Jaw Length (mm)	Length (in.)
FB593	CVD	1	6 1/8
R	MULTI	5	6 1/8
FB590	MULTI	1	6 1/8
R	MULTI	8	6 1/8
FB591		2	
R		3	
FB592		2	
R		5	

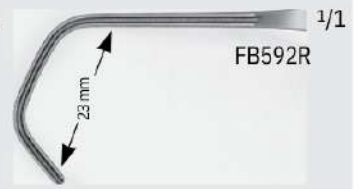
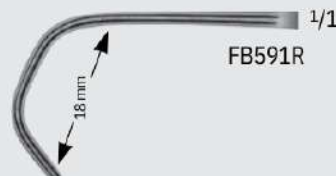
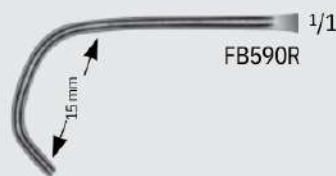
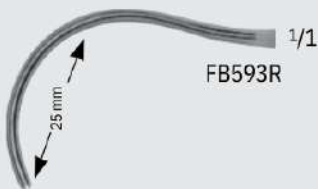
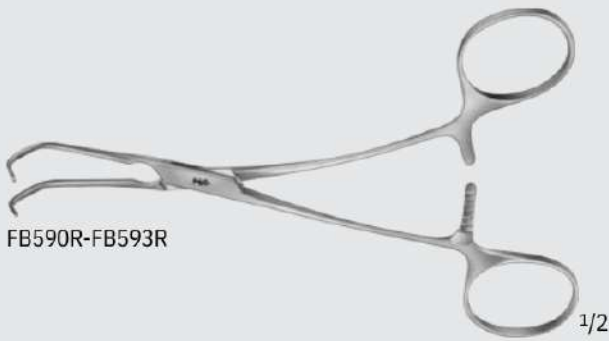

VASCIBOND

INCHES

Cardiovascular

Vascular Clamps

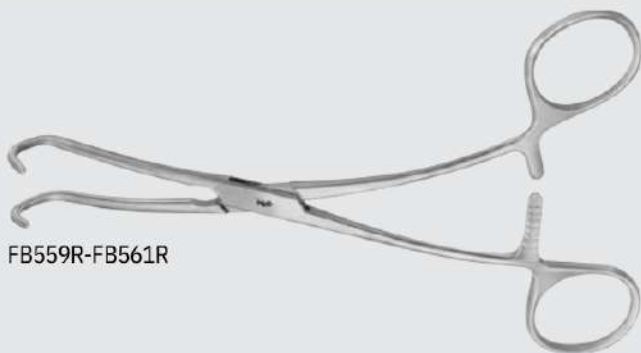

FB559R-FB561R

DERRA Atraumatic Pediatric Forceps

Catalog Number	Jaw Angle	Jaw Length (mm)	Length (in.)
FB559	MULT	1	6 3/4
R	I	6	6 3/4
FB560	MULT	2	6 7/8
R	I	0	
FB561	MULT	2	
R	I	6	



1/1

FB559R



1/1

FB560R

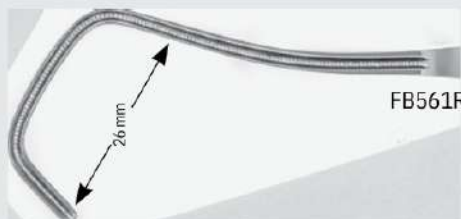

1/1

FB561R



LELAND-JONES Atraumatic Peripheral Clamp

Catalog Number	Jaw Angle	Jaw Length (mm)	Length (in.)
FB469R	STR	77	7 3/4
FB468R	15°	65	7 1/2
FB467R	30°	65	7 1/2



FB469R

1/2

1/1



77 mm

FB469R



FB467R-FB468R

1/2

1/2

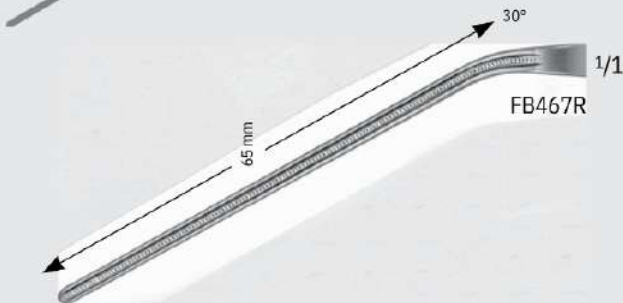

FB467R

1/1

65 mm

FB468R

1/1

65 mm

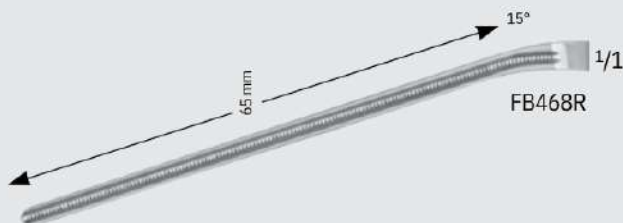

INCHES

Cardiovascular

Vascular Clamps



VASCULAR

DEBAKEY Atraumatic Suture Forceps

Catalog Number	Jaw	Jaw Length (mm)	Shaft	Length (in.)
FB483R	CVD	94	CVD	9 1/2

FB483R

1/2

1/2

1/1

94 mm

FB483R

18 mm

DIETRICH Atraumatic Aortic Clamp

Catalog Number	Jaw Angle	Jaw Length (mm)	Length (in.)
FB525R	MULTI	45	8 1/4

FB525R

1/2

1/2

1/1

75 mm

FB525R

45 mm

FB 525 R

DEBAKEY Atraumatic Forceps

Catalog Number	Jaw	Jaw Length (mm)	Length (in.)
FB484R	C-CURVE	7	7 1/2
FB498R	C-CURVE	7	8 1/4
FB485R	D-CURVE	5	9
FB499R	D-CURVE	1	9



FB484R-FB485R

1/2



FB484R

1/1



FB485R

1/1



FB498R

1/1



FB499R

1/1

HENLY Atraumatic Clamp

Catalog Number	Jaw Length (mm)	Length (in.)
FB617R	75	7 7/8



FB617R

1/2



1/2



FB617R

1/1



Cardiovascular

Vascular Clamps



VASCULAR

DEBAKEY-RUMEL Atraumatic Forceps

Catalog Number	Jaw	Jaw Length (mm)	Length (in.)
FB486R	SIGHT-CVD	81	9 3/4
FB487R	CVD	81	9 5/8

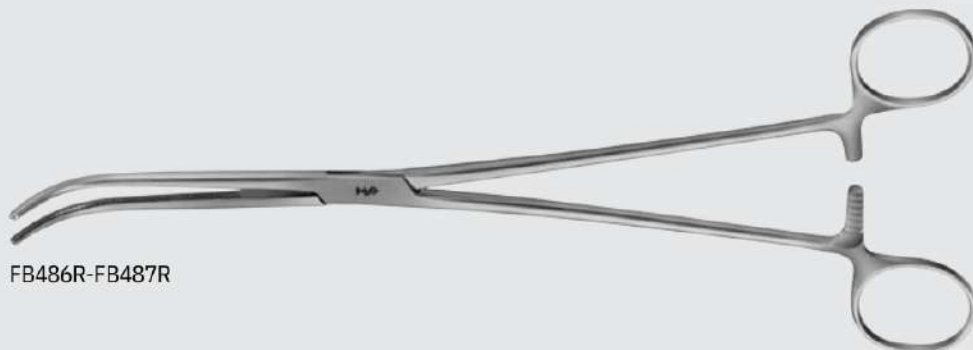

FB486R-FB487R



FB486R



FB487R

LEES Atraumatic Bronchus Clamp

Catalog Number	Jaw Angle	Jaw Length (mm)	Length (in.)
FB573R	90°	42	8 3/4



FB573R

1/2

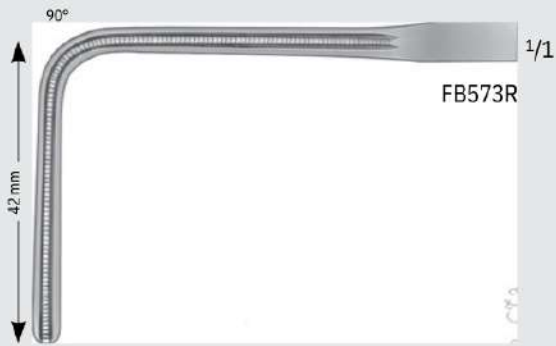

LEES Atraumatic Bronchus Clamp

Catalog Number	Jaw Angle	Jaw Length (mm)	Shaft	Length (in.)
FB574R	ANG	40	CVD	9 5/8



FB574R

1/2

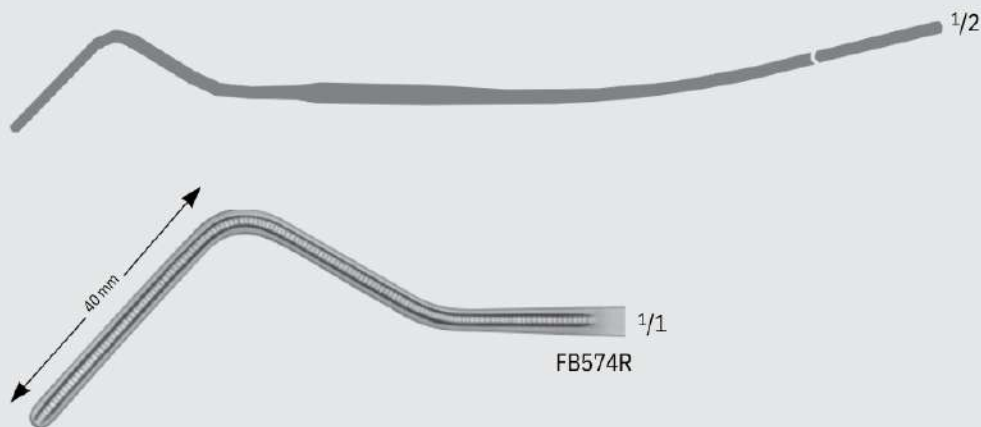

FB574R

1/1



INCHES

Cardiovascular

Vascular Clamps

DEBAKEY Atraumatic Multi-Purpose Clamp

Catalog Number	Jaw Angle	Jaw Length (mm)	Length (in.)
FB510	60°	40	9 1/2
R	°	55	8 3/4
FB511	60°	65	11
R	°	100	12

FB512 60°
R °
FB513 60°
R °



FB510R-FB513R

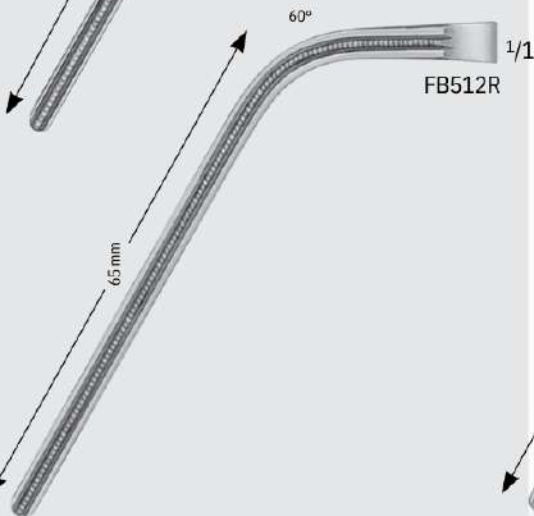
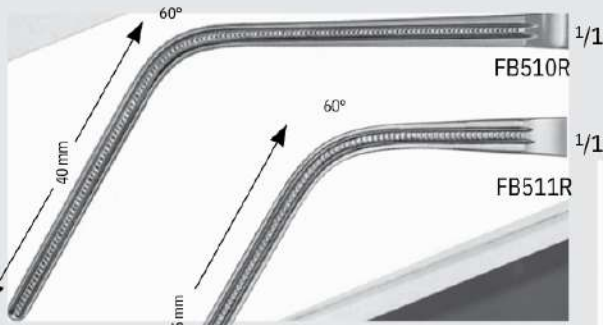

FB 513 R



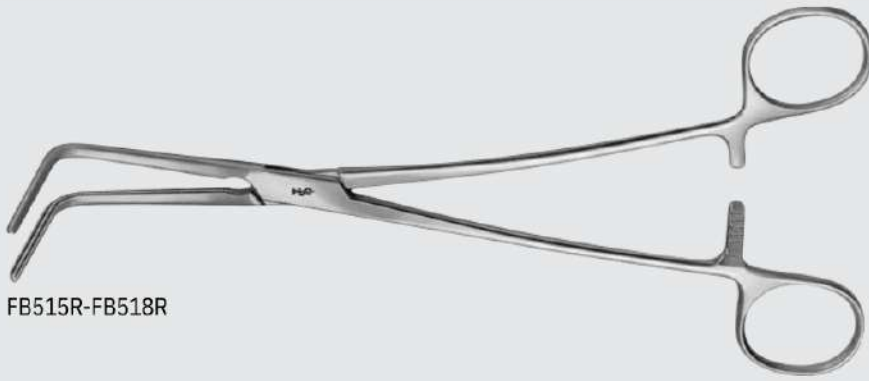

FB515R-FB518R

DEBAKEY Atraumatic Multi-Purpose Clamp

Catalog Number	Jaw Angle	Jaw Length (mm)	Length (in.)
FB515	90	45	8 7/8
R	°	55	8 1/4
FB516	90	72	10
R	°	108	10 3/4

FB517	90		
R	°		
FB518	90		
R	°		

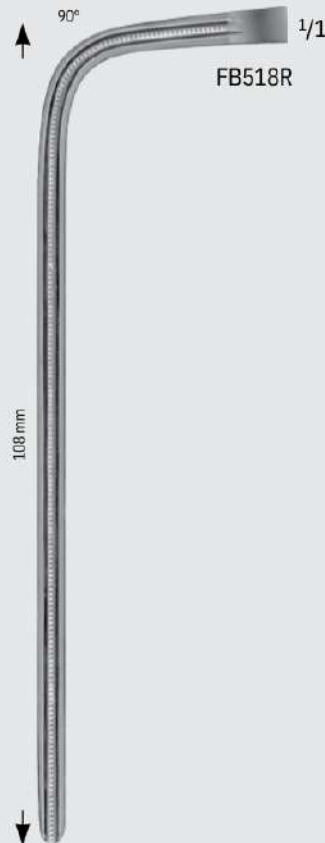
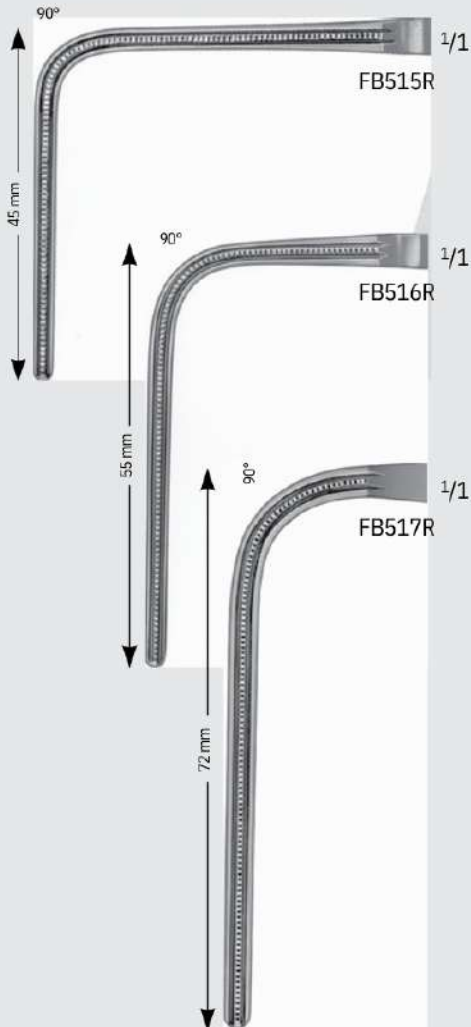

INCHES

Cardiovascular

Vascular Clamps



LEMOLE-STRONG Atraumatic Clamp, Angled Shaft

Catalog Number	Jaw Size (mm)	Length (in.)
FB618	40 x 15	7 7/8
R	45 x 20	7 7/8

FB619
R

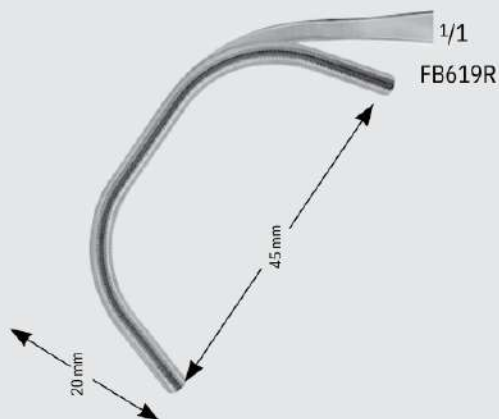
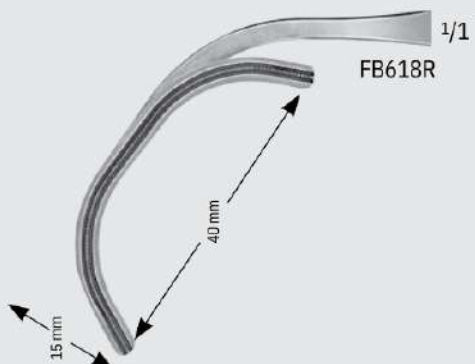

STRONG Aorta Clamp, Straight Shaft

Catalog Number	Jaw	Length (in.)
MG074R	CVD	7 7/8

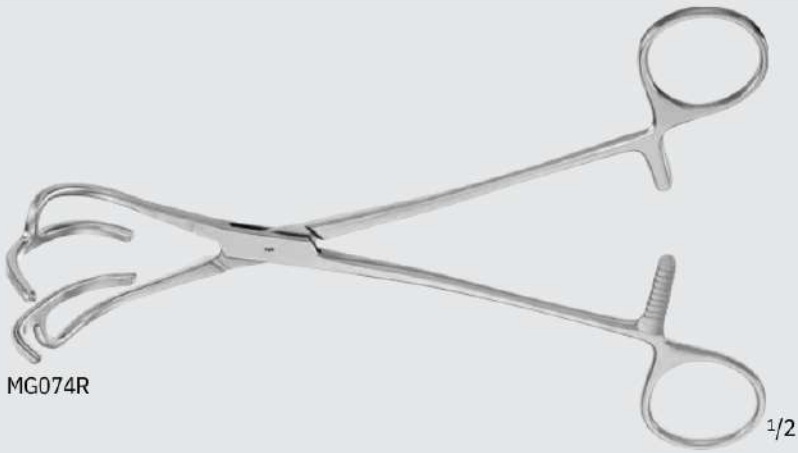

MG074R

1/2

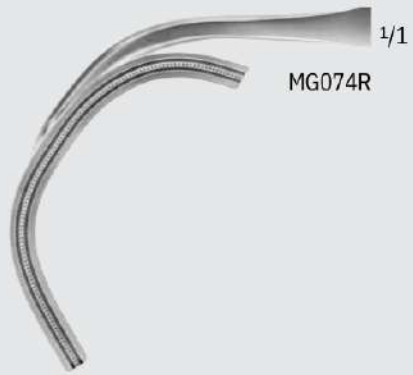

MG074R

1/1



Cardiovascular

Vascular Clamps

WYLIE Hypogastric Clamp

Catalog Number	Jaw	Jaw Length (mm)	Shaft	Length (in.)
MB241	CVD	70	ANG	8 1/2
MB240	CVD	75	ANG	9 3/4

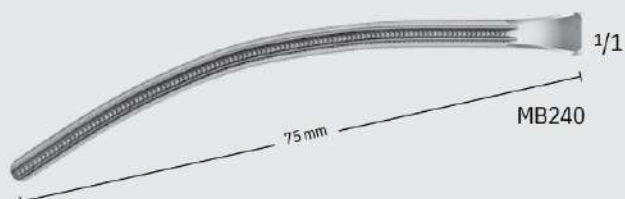



FB669R-FB670R

WYLIE Atraumatic Clamp

Catalog Number	Jaw	Length (in.)
FB669	HEAVY-CVD	8 3/4
R	CVD-BACK	9

FB670

R

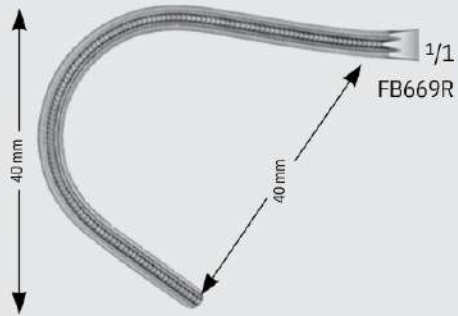

1/1
FB669R

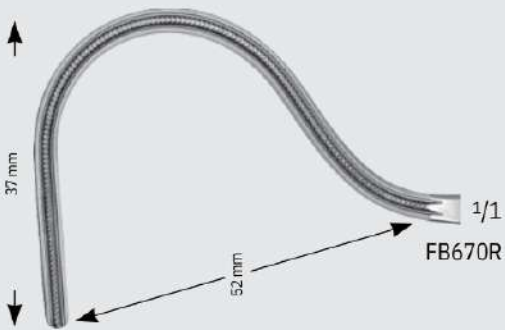

1/1
FB670R



INCHES

Cardiovascular

Vascular Clamps

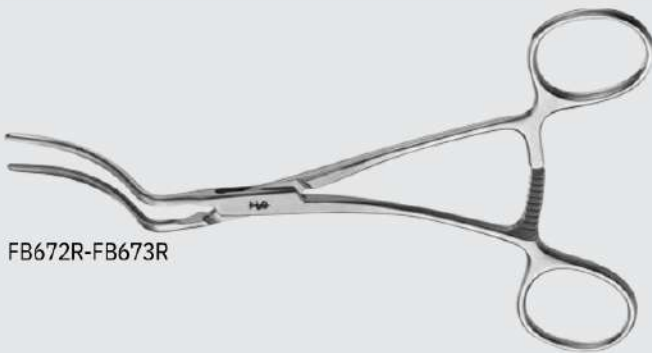

FB672R-FB673R

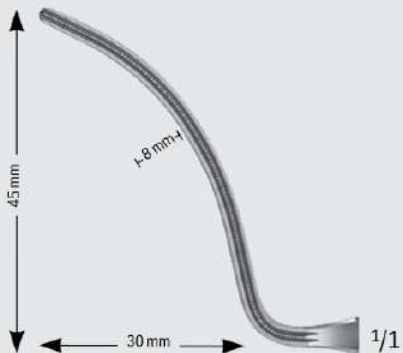

FB672R

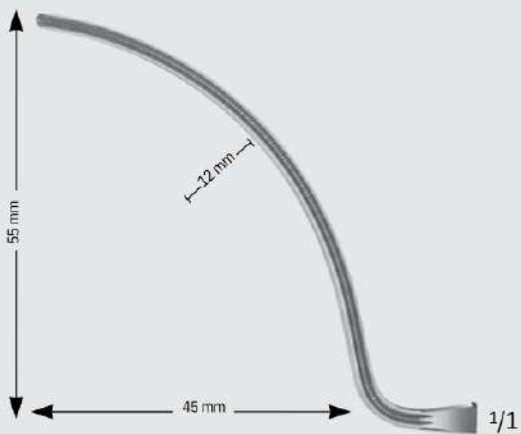

FB673R

WYLIE Atraumatic Clamp

Catalog Number	Jaw	Length (in.)
FB672	CVD-UP	6 1/4
R	CVD-UP	7

FB673
R

WYLIE Atraumatic Clamp

Catalog Number	Jaw	Length (in.)
FB674	CVD-DOWN	6
R	CVD-DOWN	6 1/2

FB675

R

FB674R-FB675R

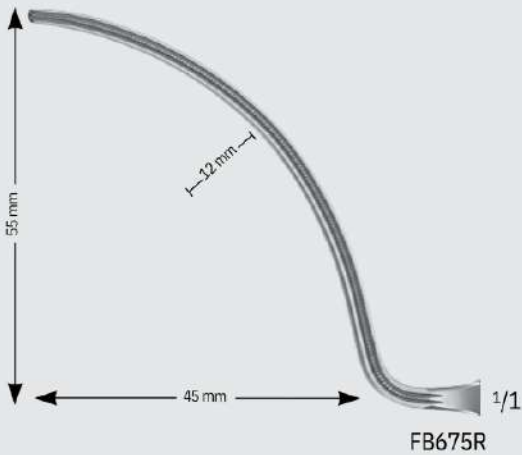
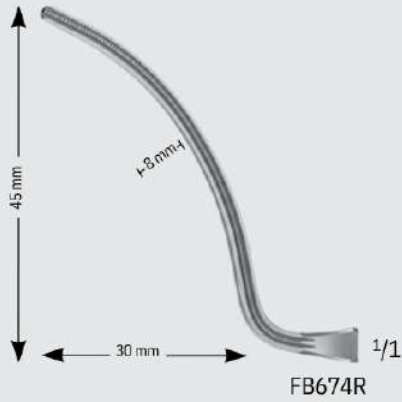

Cardiovascular

Vascular Clamps



VASCULAR

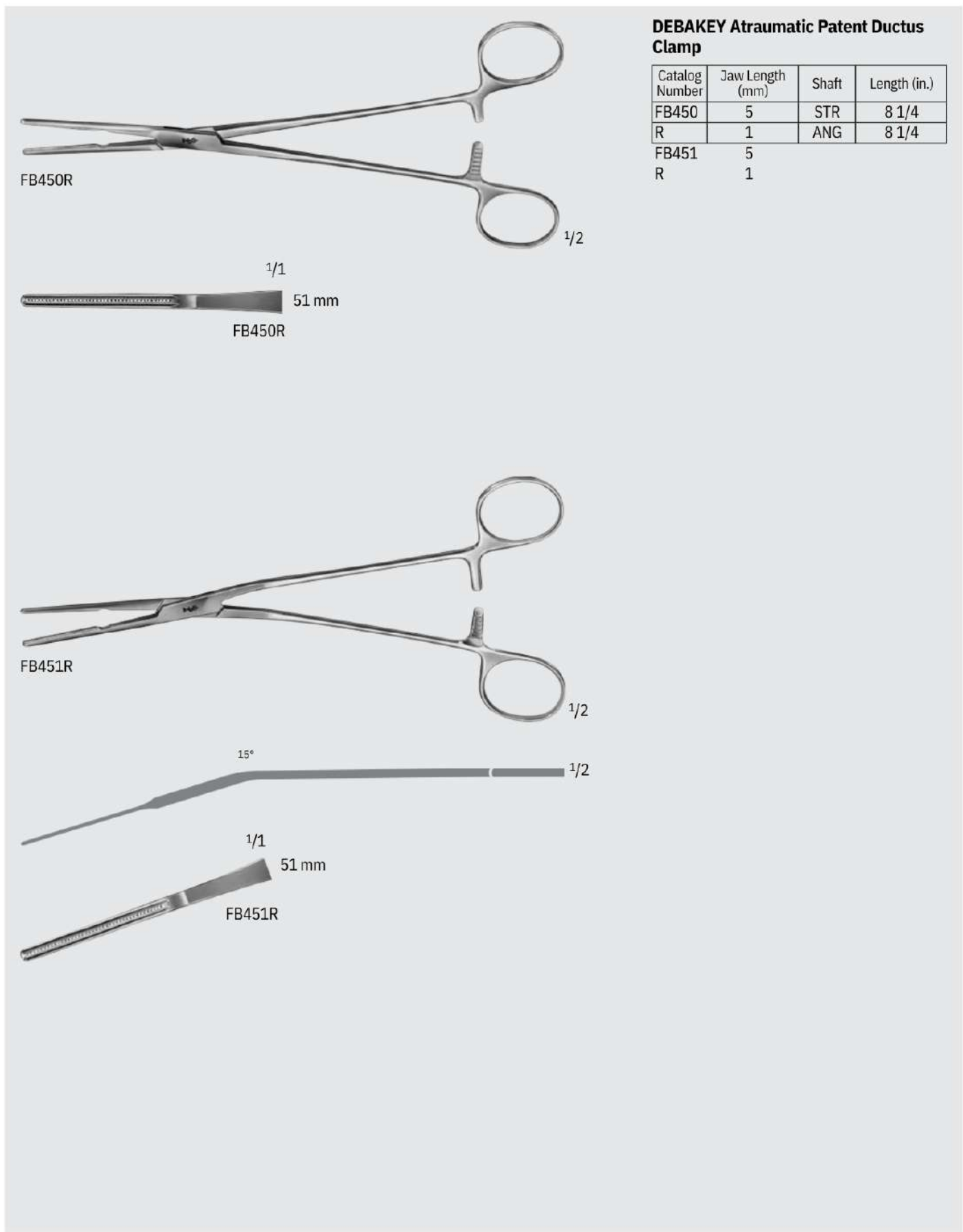

DEBAKEY Atraumatic Patent Ductus Clamp

Catalog Number	Jaw Length (mm)	Shaft	Length (in.)
FB450	5	STR	8 1/4
R	1	ANG	8 1/4
FB451	5		
R	1		

FB450R

1/1

51 mm

FB450R

1/2

FB451R

15°

1/1

51 mm

FB451R

1/2

1/2



FB453R-FB457R



15°



FB453R



FB553R



FB455R



FB457R

DEBAKEY Atraumatic Coarctation Clamp

Catalog Number	Jaw Length (mm)	Shaft	Length (in.)
FB453	4	ANG	7 7/8
R	1	ANG	6 1/2
FB553	5	ANG	8 7/8
R	0	ANG	9 1/2

FB455	6
R	5
FB457	8
R	0



INCHES

Cardiovascular

Vascular Clamps



FB452R-FB552R

DEBAKEY Atraumatic Coarctation Clamp

Catalog Number	Jaw	Jaw Length (mm)	Length (in.)
FB452	ST	4	8
R	R	1	6 3/4
FB552	ST	5	8 7/8
R	R	0	9 1/2
FB454	ST	6	
R	R	5	
FB456	ST	8	
R	R	0	



1/1
FB452R



1/1
FB552R



1/1
FB454R



1/1
FB456R



MG423R

1/2

NOON AV Fistula Clamp

Catalog Number	Jaw Angle	Length (in.)
MG423R	50°	4 3/4

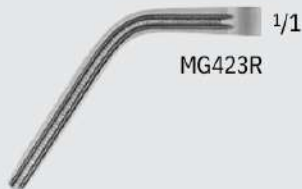

1/1
MG423R

GLOVER Atraumatic Clamp

Catalog Number	Jaw	Jaw Length (mm)	Length (in.)
FB458R	FB460R SPOON SHAPED	6	8 1/2
FB550R	SPOON SHAPED	5	8 3/4
FB459R	CVD	0	9 5/8
FB461R	FULL-CVD	7	7 3/4
FB462R	FULL-CVD	0	8 1/4

R 8
 FB462 6
 R 4
 7
 6
 3



FB458R-FB550R

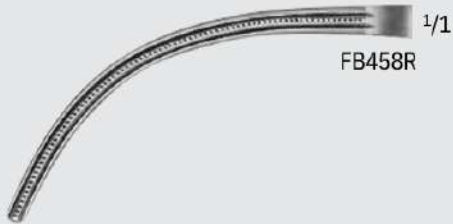

FB458R

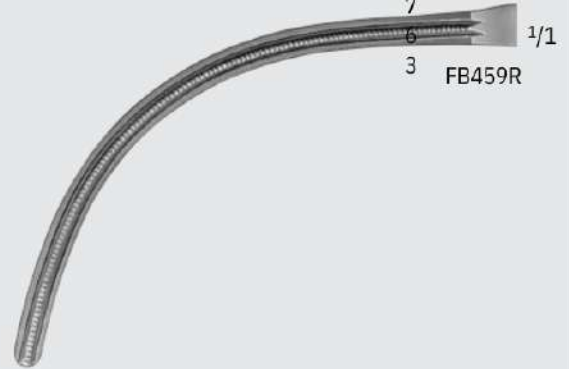

FB459R



FB460R

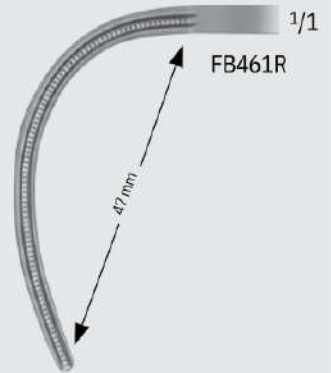

FB461R



FB550R

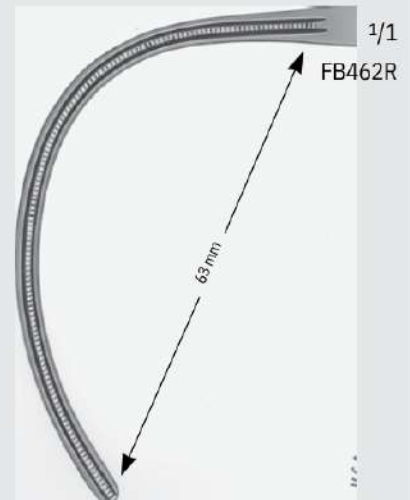

FB462R



Cardiovascular

Vascular Clamps



MB893R, MB895R



MB893R



MB895R



MB894R, MB896R



MB894R



MB896R

GLOVER Coarctation Clamp

Catalog Number	Jaw	Jaw Length (mm)	Length (in.)
MB893R	STR	6	9
MB895R	STR	0	10 1/4
MB894R	ANG	7	8 3/4
MB896R	ANG	0	10

6
0
7
0

GREGORY Atraumata Profunda Clamp

Catalog Number	Jaw	Jaw Length (mm)	Length (in.)
MG014R	X-SMALL	2	5
MB750R	SMALL	9	5 3/4
MB751R	MEDIUM	5	7
MB752R	LARGE	7	7 3/4

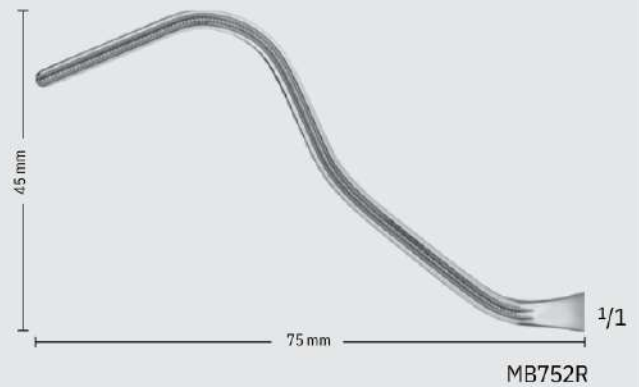
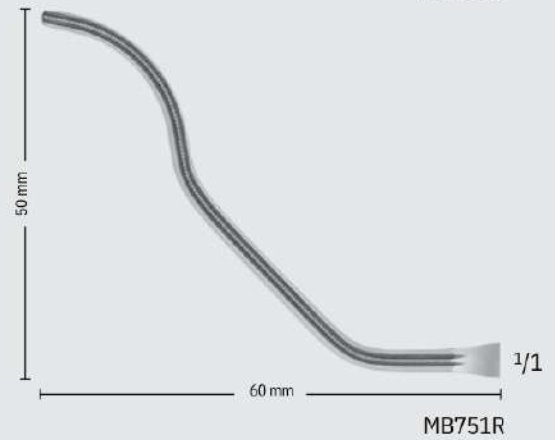
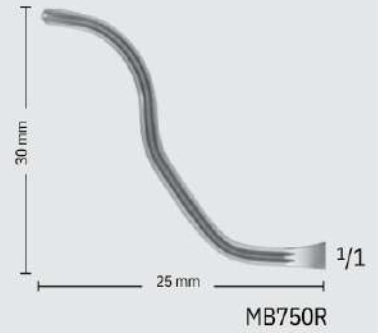
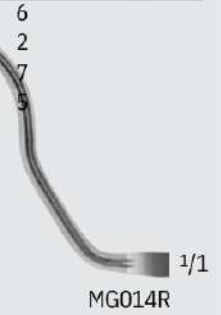
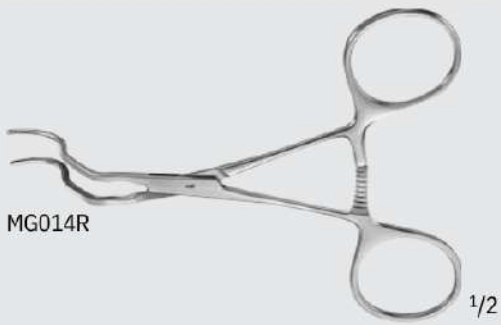

Cardiovascular

Vascular Clamps

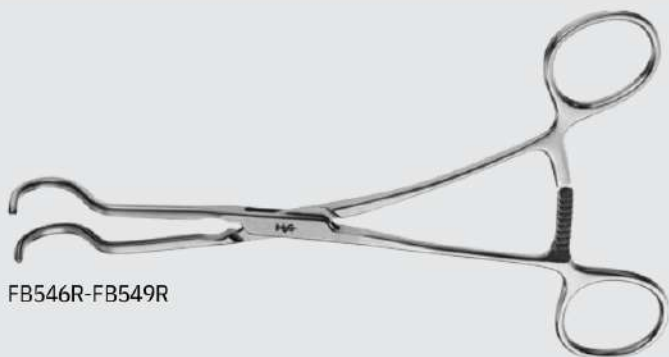

FB546R-FB549R

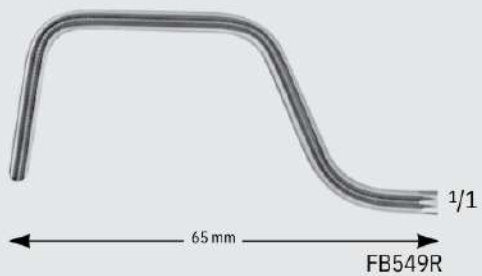
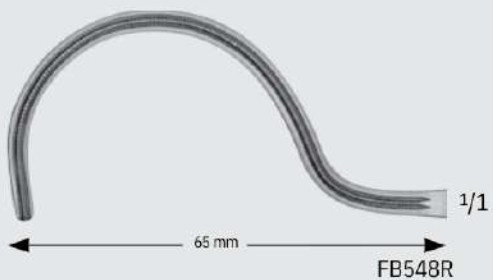
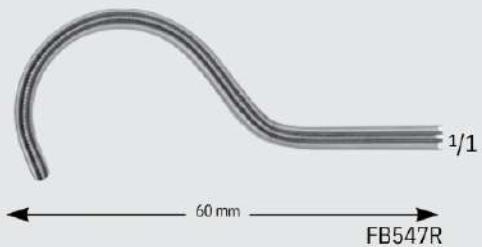
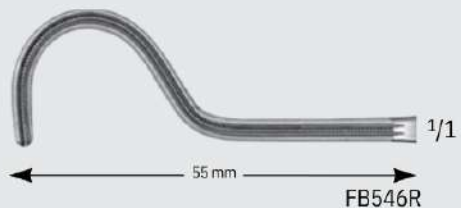

DALE Femoral Popliteal Clamp

Catalog Number	Jaw	Length (in.)
FB546	SMALL	6 7/8
R	MEDIUM	7
FB547	LARGE	7
R	-	7

FB548
R
FB549
R

SELMAN Vessel Forceps

Catalog Number	Jaw	Jaw Length (mm)	Length (in.)
MG361R	STR	2	5 1/4
MG362R	COOLEY SERR	5	5 1/4
	ANG,		
	COOLEY SERR		



1/2



1/1



1/2



1/1



INCHES

Cardiovascular

Vascular Clamps



VASCULAR

CHERRY Clamp

Catalog Number	Jaw	Teeth	Shaft	Length (in.)
MG368CVD		2 x 3	60° ANG	12 3/8

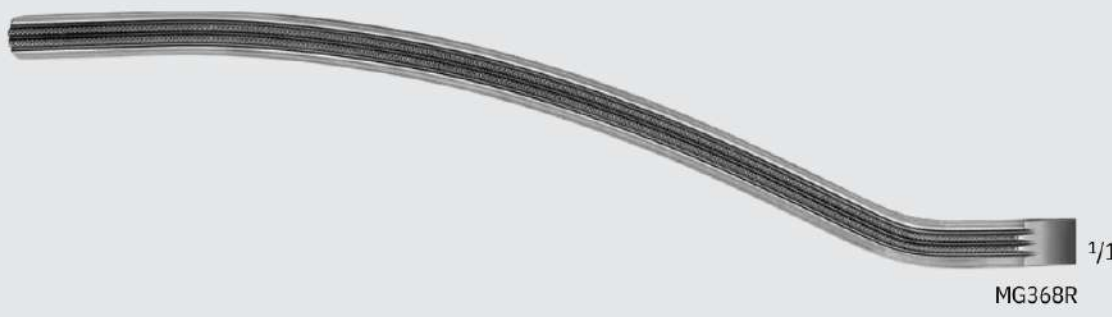

DEBAKEY Atraumatic Peripheral Clamp #1

Catalog Number	Jaw Length (mm)	Length (in.)
FB463R	56	6 1/4

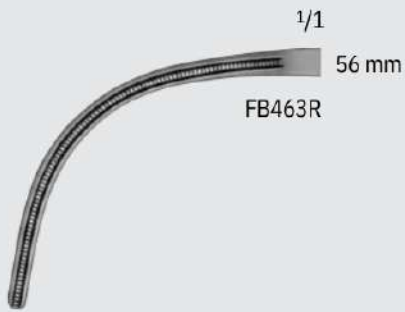

DEBAKEY Atraumatic Peripheral Clamp #2

Catalog Number	Jaw Length (mm)	Length (in.)
FB464R	90	7 1/2

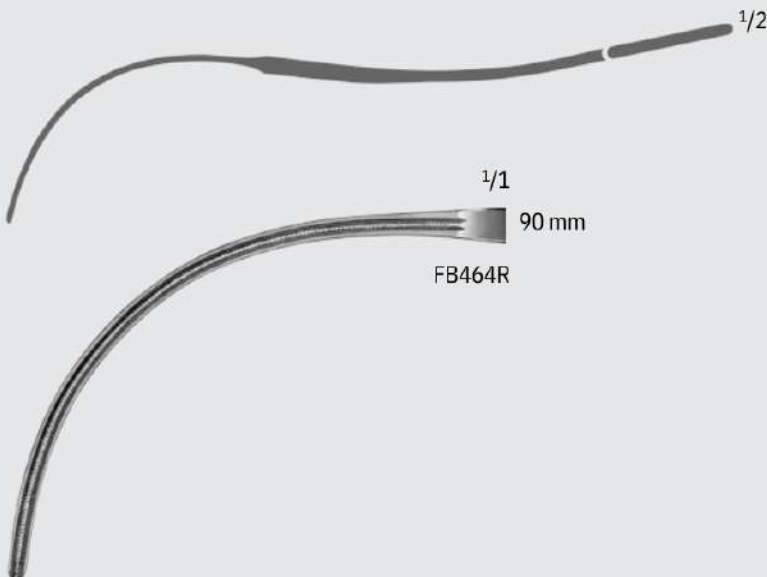

Cardiovascular

Vascular Clamps



VASCULAR



FB465R

1/2



1/2

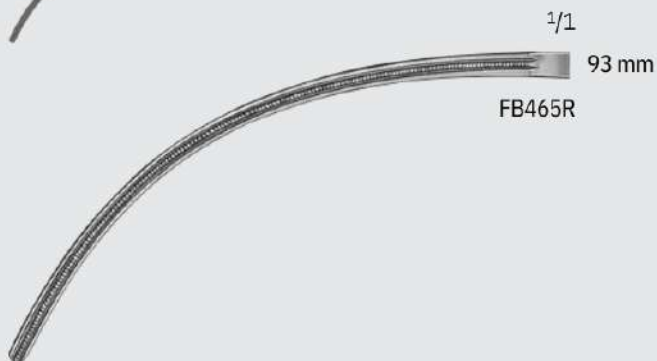

1/1

93 mm

FB465R

DEBAKEY Atraumatic Peripheral Clamp #3

Catalog Number	Jaw Length (mm)	Length (in.)
FB465R	93	7 7/8

DEBAKEY Atraumatic Peripheral Clamp #4

Catalog Number	Jaw Angle	Jaw Length (mm)	Length (in.)
FB466R	60°	77	7

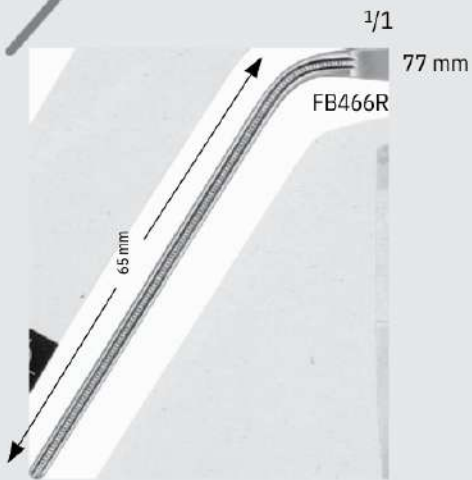
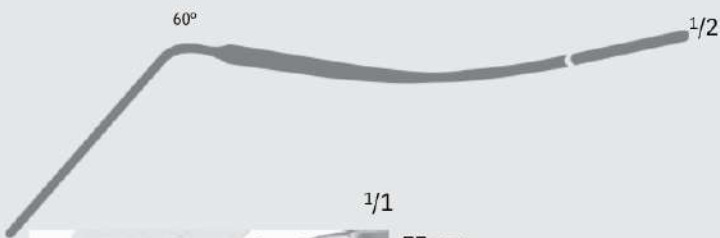

Cardiovascular

Vascular Clamps



VASCULAR

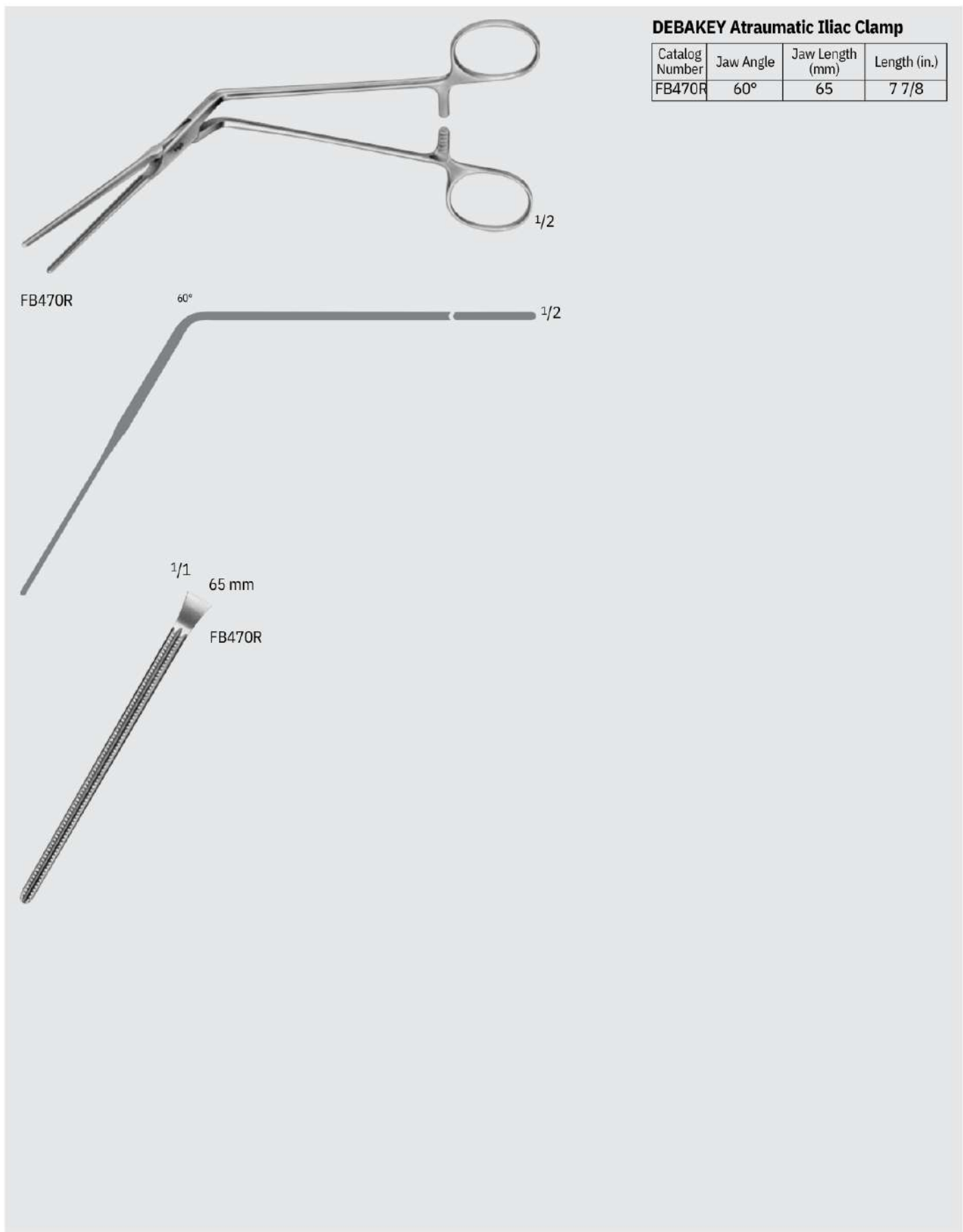

DEBAKEY Atraumatic Iliac Clamp

Catalog Number	Jaw Angle	Jaw Length (mm)	Length (in.)
FB470R	60°	65	7 7/8

COOLEY Aortic Aneurysm Clamp

Catalog Number	Jaw CVD	Jaw Length (mm)	Length (in.)
MG448R	CVD	75	10

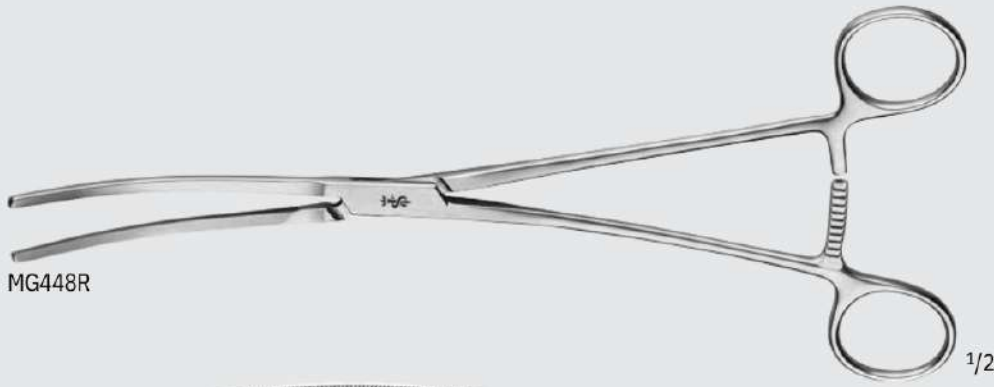

MG448R

1/2



1/1

MG448R



Cardiovascular

Vascular Clamps

DEBAKEY Atraumatic Aortic Aneurysm Clamp, Light Curved

Catalog Number	Jaw	Jaw Length (mm)	Length (in.)
FB471R	2 x 3 SERR	95	9 3/4
FB472R	2 x 3 SERR	110	11 3/4
FB473R	2 x 3 SERR	130	12 3/8
FB480R	2 x 3 SERR	140	12 3/4



FB471R-FB473R, FB480R



FB471R 1/1



FB472R 1/1



FB473R 1/1



FB480R 1/1



DEBAKEY Atraumatic Aortic Aneurysm Clamp

Catalog Number	Jaw	Jaw Length (mm)	Length (in.)
FB478R	SLIGHT-CVD	70	10
FB477R	CVD	75	10 1/2
FB476R	HEAVY-CVD	85	11



FB476R-FB478R



FB478R



FB477R



FB476R



Cardiovascular

Vascular Clamps

DEBAKEY Atraumatic Aortic Aneurysm Clamp, S-Curved

Catalog Number	Jaw Length (mm)	Length (in.)
FB475R	115	11 3/4



FB475R

1/2



1/2



1/1

FB475R



DEBAKEY-SEMB Atraumatic Aortic Aneurysm Clamp, Curved

Catalog Number	Jaw Length (mm)	Length (in.)
FB482R	100	10 1/2



Cardiovascular

Vascular Clamps

DEBAKEY Atraumatic Aortic Aneurysm Clamp, Full Curved

Catalog Number	Jaw Length (mm)	Length (in.)
FB481R	111	10 5/8

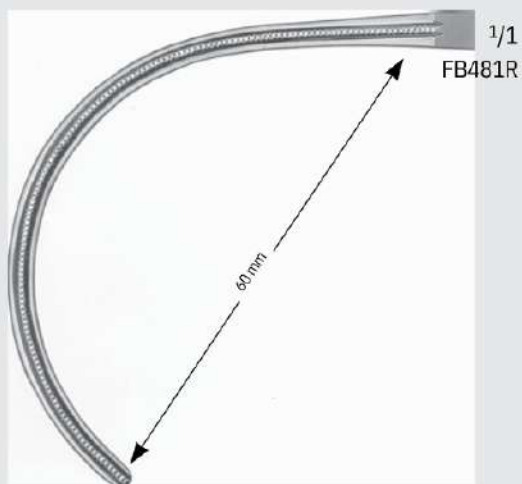

WEBER Atraumatic Aortic Clamp, Left

Catalog Number	Jaw Length (mm)	Length (in.)
FB488R	113	10 1/4

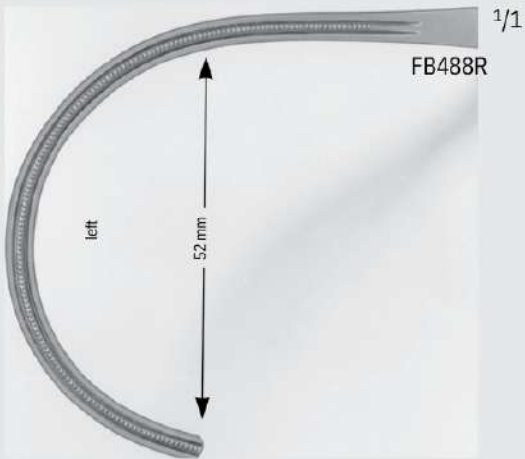

Cardiovascular

Vascular Clamps

WEBER Atraumatic Aortic Clamp, Right

Catalog Number	Jaw Length (mm)	Length (in.)
FB489R	113	10 1/4

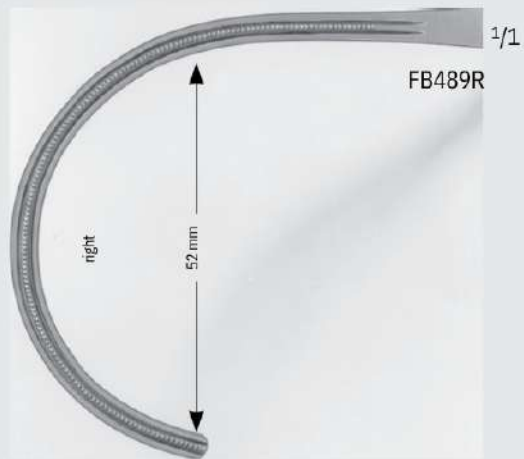
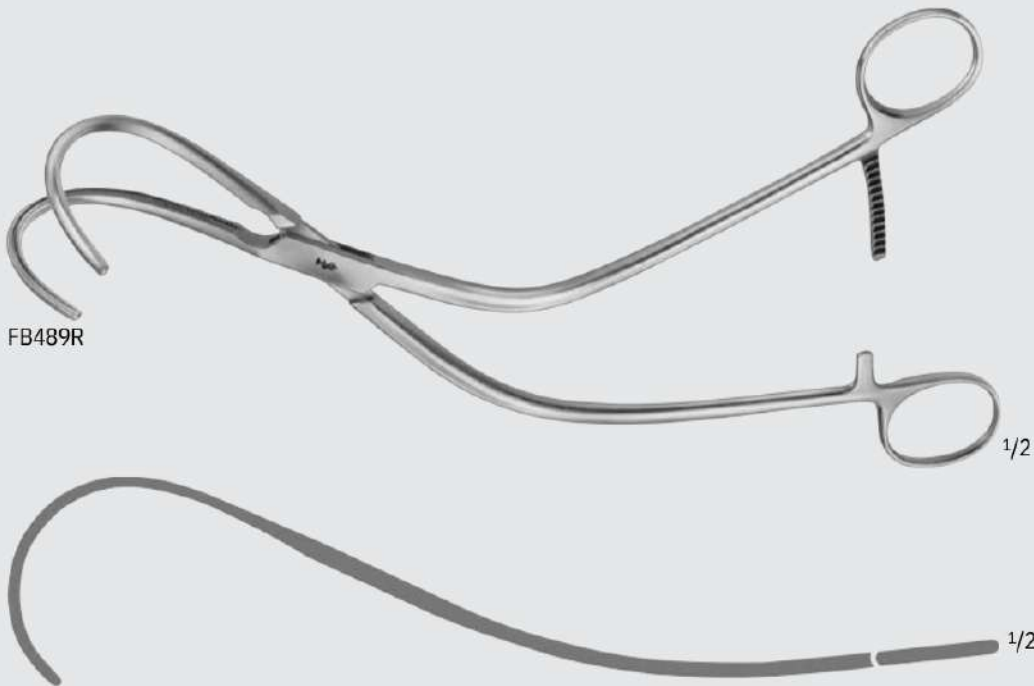

LAMBERT-KAY Atraumatic Aortic Clamp

Catalog Number	Weight	Jaw Length (mm)	Length (in.)
FB490	LIGHT	93	8 1/2
R	HEAVY	100	8 1/4

FB492
R



FB490R-FB492R

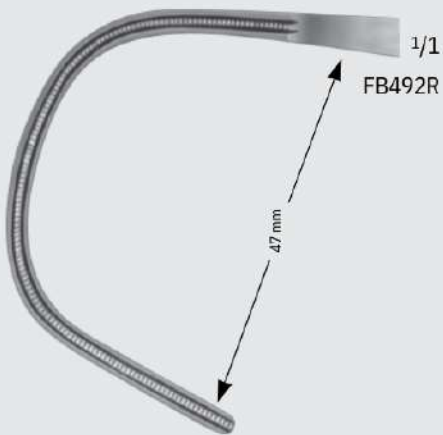
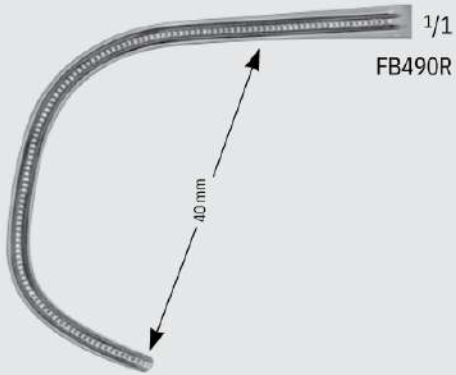

INCHES

Cardiovascular

Vascular Clamps

DEBAKEY-LAMBERT Atraumatic Aortic Clamp

Catalog Number	Jaw Angle	Jaw Length (mm)	Length (in.)
FB491R	MULTI	40	10

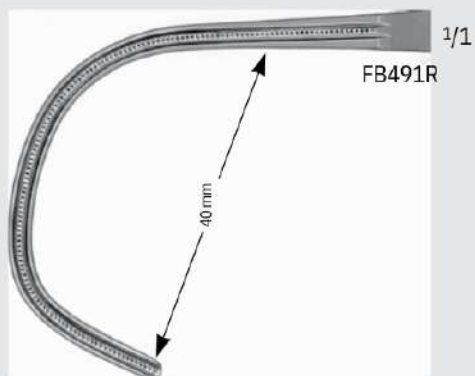

MORRIS Atraumatic Aortic Cross Clamp

Catalog Number	Jaw Angle	Jaw Length (mm)	Length (in.)
FB493R	70°	67	6 7/8

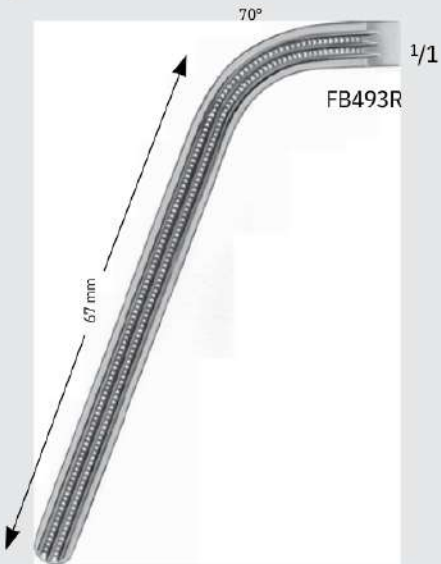
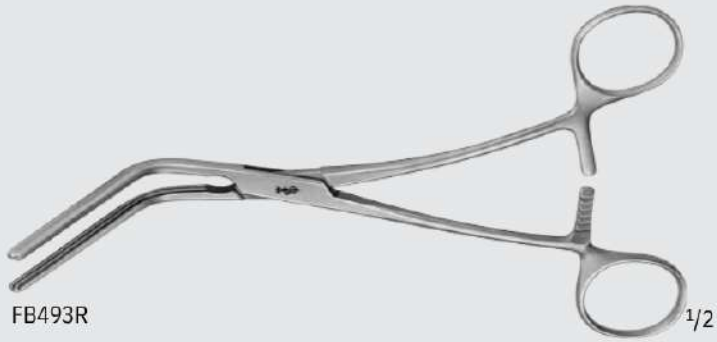

Cardiovascular

Vascular Clamps

DEBAKEY-MORRIS Atraumatic Cross-Clamp

Catalog Number	Jaw Angle	Jaw Length (mm)	Length (in.)
FB494R	70°	70	9 1/2

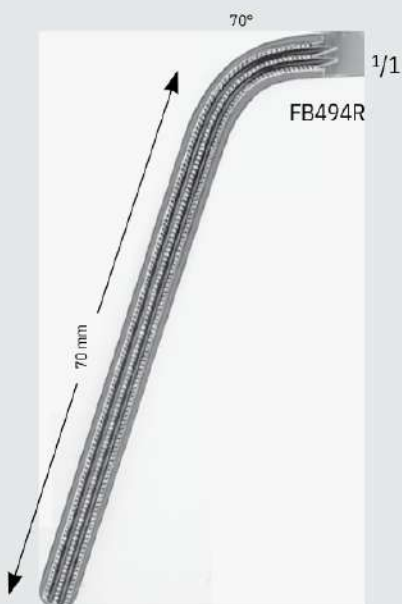

OCHSNER Atraumatic Aortic Clamp

Catalog Number	Jaw Angle	Jaw Length (mm)	Length (in.)
FB495R	70°	50	10 1/4

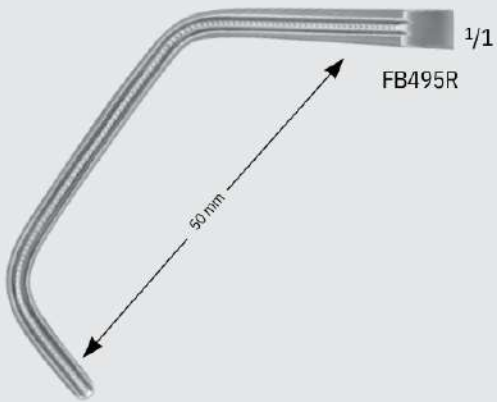

Cardiovascular

Vascular Clamps



FB519R-FB520R

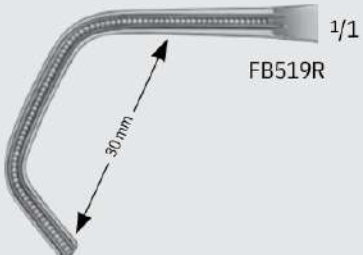

FB519R

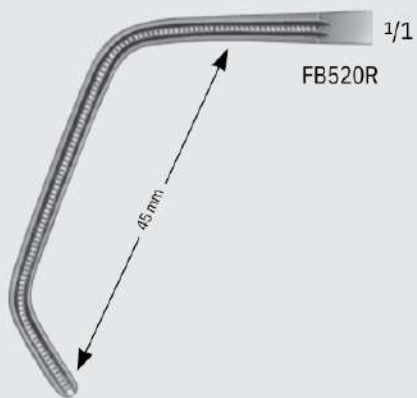

FB520R

DEBAKEY-BECK Atraumatic Vena Cava Clamp

Catalog Number	Jaw Length (mm)	Length (in.)
FB519	3	8
R	0	8 1/4
FB520	4	
R	5	





FB500R-FB504R

DEBAKEY Atraumatic Tangential Clamp

Catalog Number	Jaw Size (#)	Jaw Length (mm)	Length (in.)
FB500	1	3	8 3/4
R	2	8	10 1/2
FB501	3	4	10 5/8
R	4	8	10 5/8
FB502	5	5	11

R 4
 FB503 5
 R 8
 FB504 7
 R 5

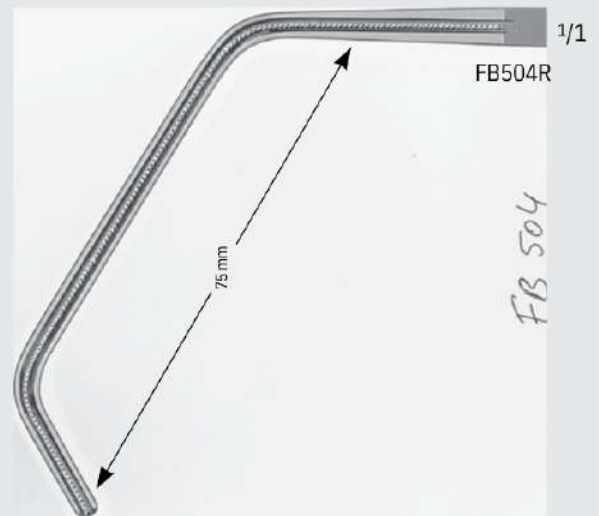
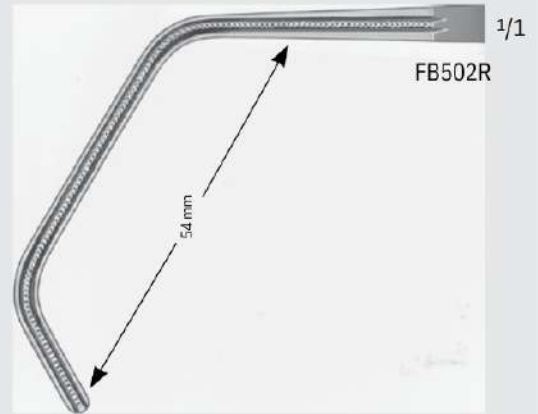
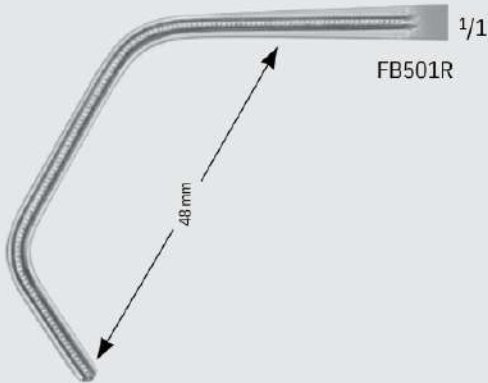
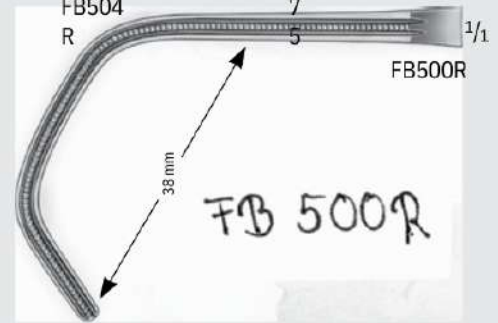

Cardiovascular

Vascular Clamps

DEBAKEY-SATINSKY Atraumatic Tangential Clamp

Catalog Number	Jaw Length (mm)	Length (in.)
FB506	3	9 1/4
R	2	9 1/2
FB507	4	9 5/8
R	0	
FB508	4	
R	7	

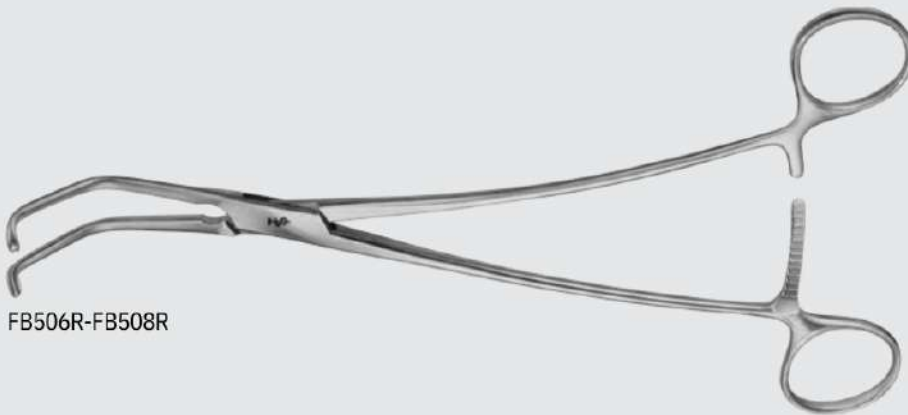

FB506R-FB508R

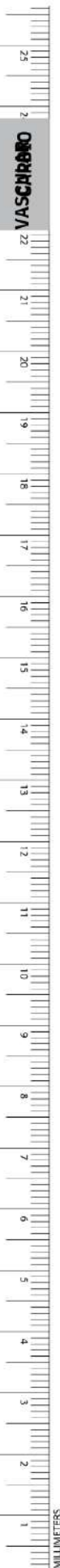
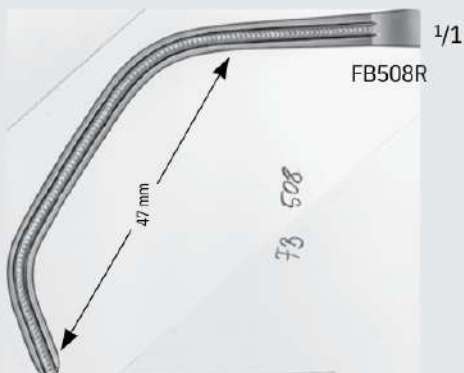
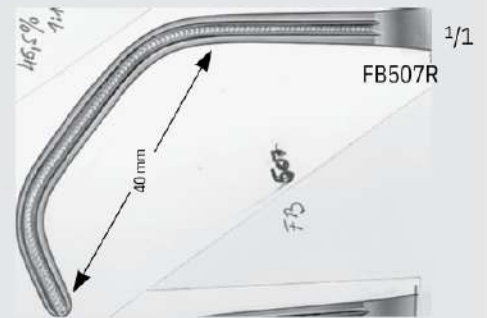
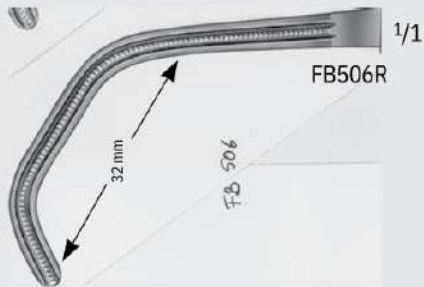

**DEBAKEY Atraumatic Sidewinder
Aortic Clamp**

Catalog Number	Jaw Angle	Jaw Length (mm)	Length (in.)
FB576R	70°	60	10 1/2



1/1

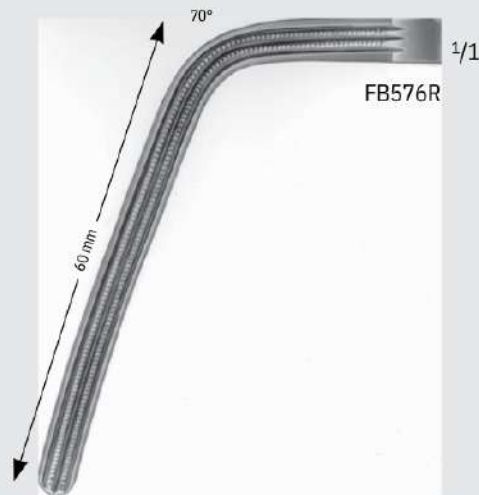

INCHES

Cardiovascular

Vascular Clamps



VASCULAR

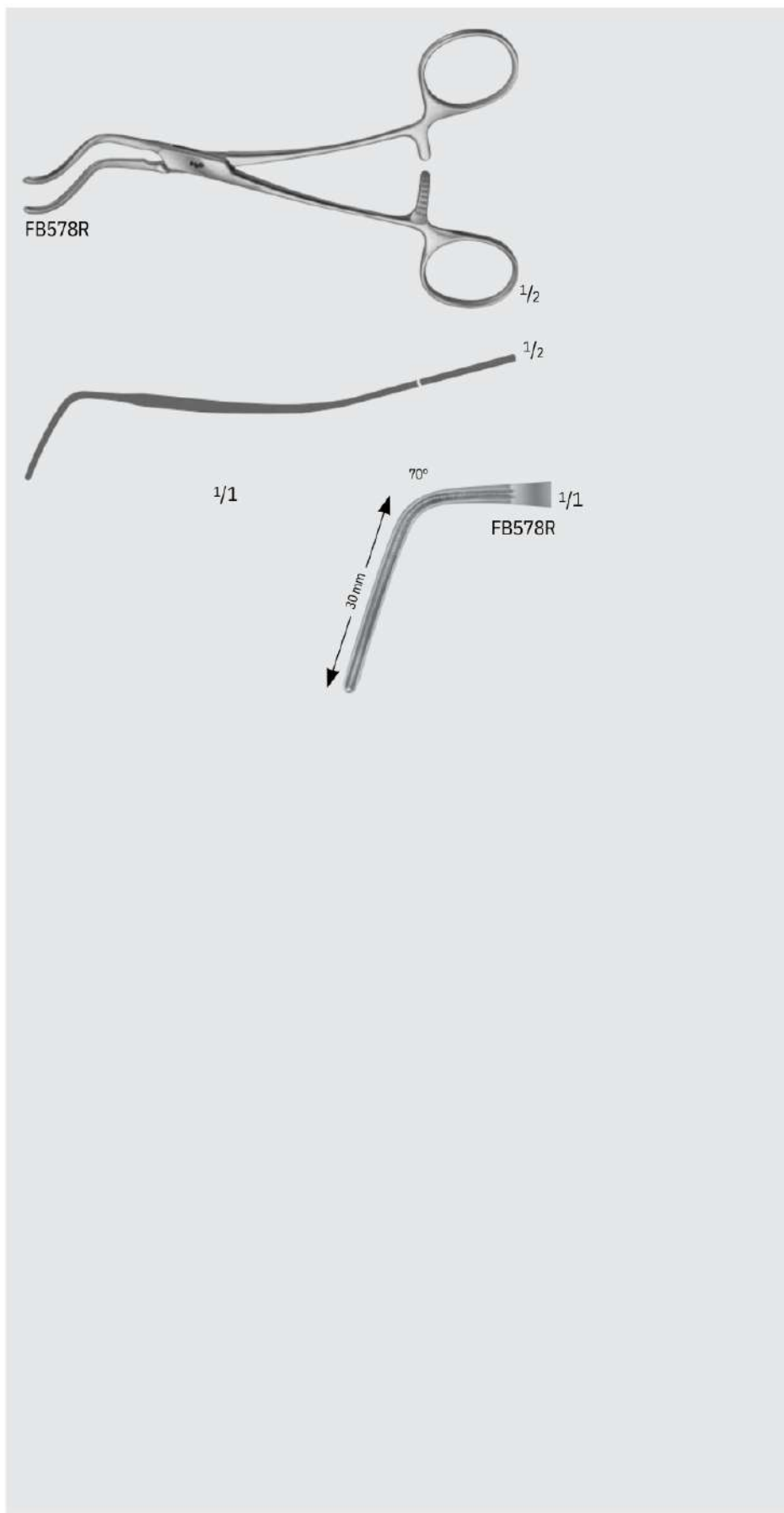

DEBAKEY-SUBRAMANIAN Atraumatic Aortic Clamp

Catalog Number	Jaw Angle	Jaw Length (mm)	Length (in.)
FB578R	70°	30	6 1/8

DEBAKEY Vascular Clamp

Catalog Number	Jaw Angle	Jaw Length (mm)	Length (in.)
US123	60	4	4 1/4
US124	°	0	3 3/4
	90	4	
	°	0	

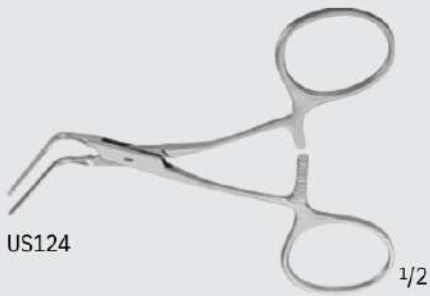
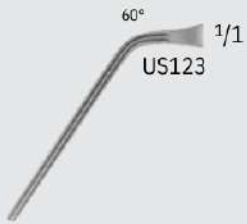
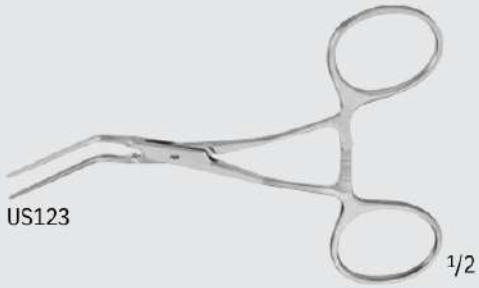

DEBAKEY Partial Occlusion Clamp

Catalog Number	Jaw Angle	Jaw Length (mm)	Length (in.)
US125	MULTI	24	4 1/2



Cardiovascular

Vascular Clamps



COOLEY Atraumatic Ring Handle Bulldog Clamp

Catalog Number	Shaft Angle	Jaw Angle	Jaw Length (mm)	Length (in.)
FB700R	STR	STR	50	5
FB702R	STR	CVD	50	4 1/2
FB701R	15° ANG	STR	50	5
FB703R	SLIGHT-CVD	CVD	50	5
FB704R	SLIGHT-CVD	40°	37	4 3/4
FB706R	SLIGHT-CVD	MULTI	52	5
FB705R	CVD	MULTI	50	4 3/4
FB707R	CVD	90°	12	4 1/4
FB708R	ANG		41	4

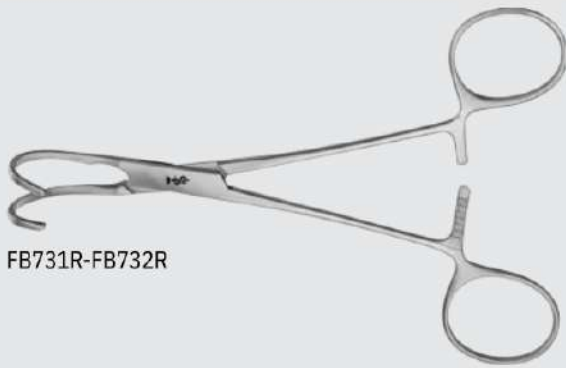

FB731R-FB732R

COOLEY-BECK Atraumatic Pediatric Clamp, Curved

Catalog Number	Jaw Length (mm)	Length (in.)
FB731	2	6
R	5	6 1/8
FB732	3	
R	0	

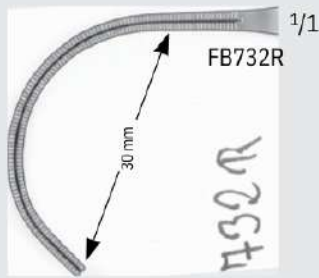
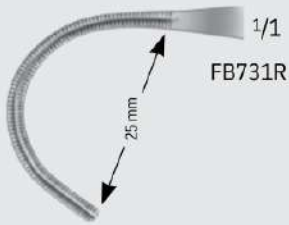

COOLEY Atraumatic Peripheral Vascular Clamp, Angled

Catalog Number	Jaw Length (mm)	Length (in.)
MB233	65	7

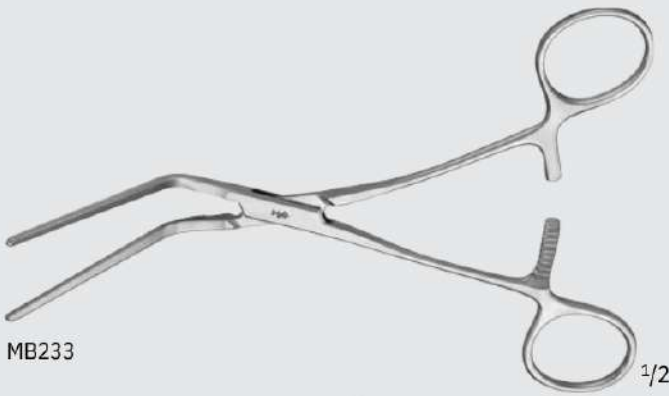

MB233

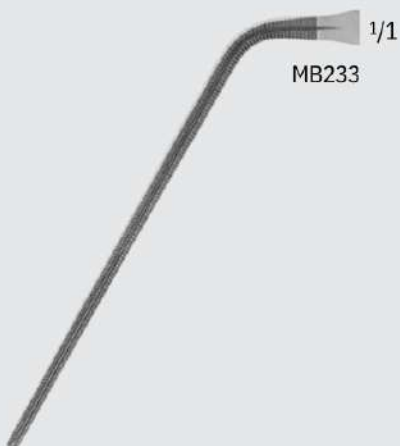

Cardiovascular

Vascular Clamps



VASCULAR

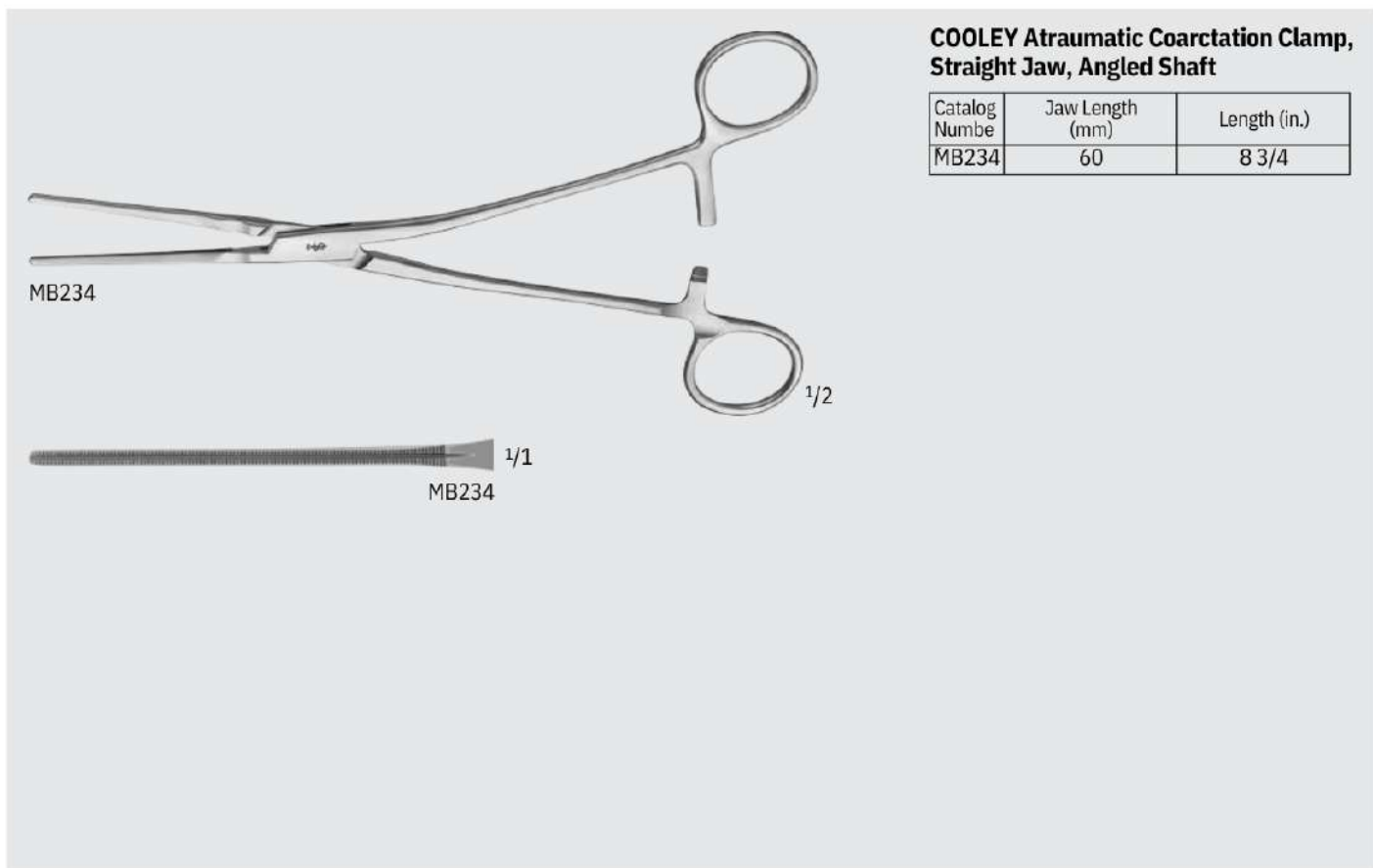

COOLEY Atraumatic Coarctation Clamp, Straight Jaw, Angled Shaft

Catalog Number	Jaw Length (mm)	Length (in.)
MB234	60	8 3/4

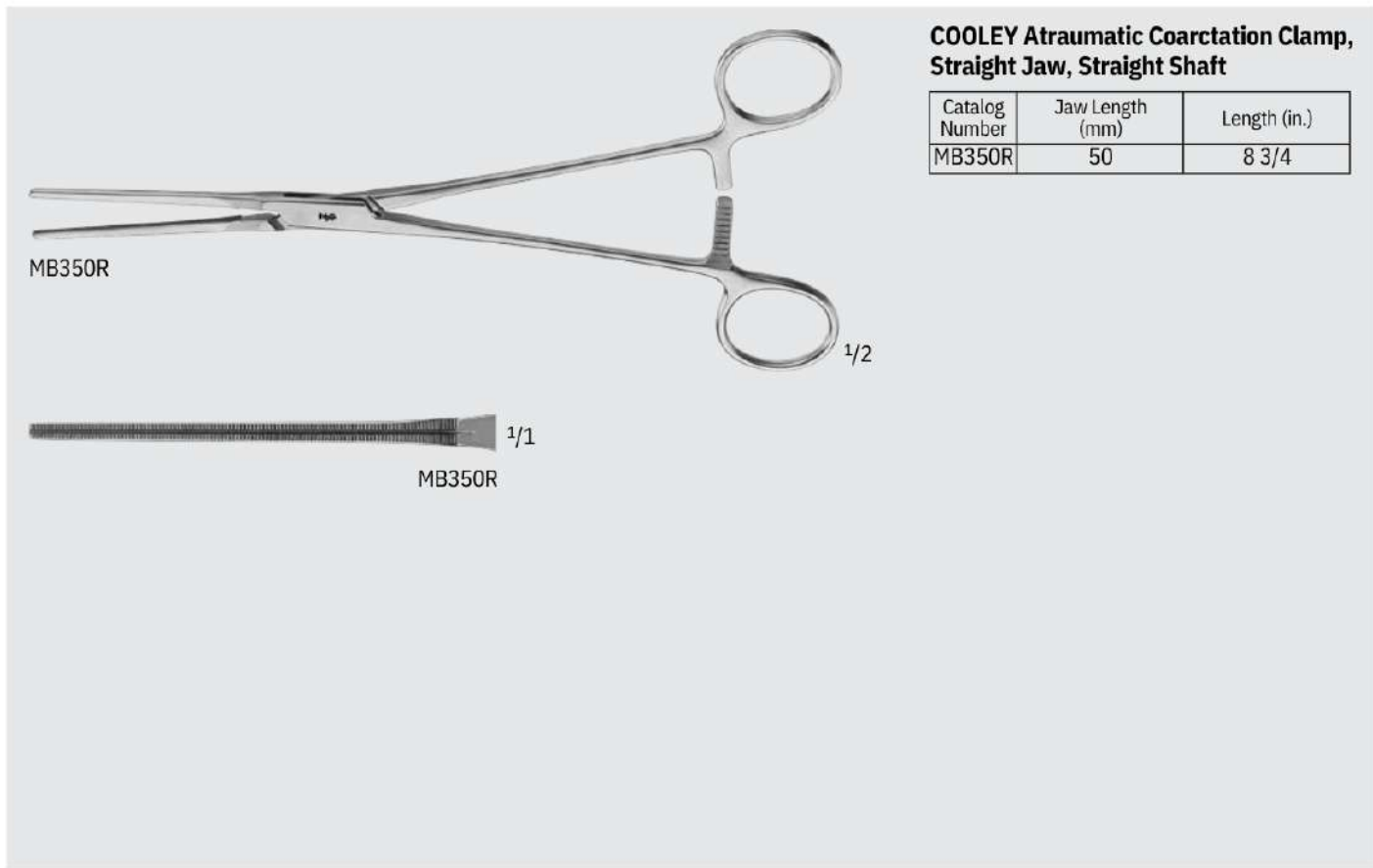

COOLEY Atraumatic Coarctation Clamp, Straight Jaw, Straight Shaft

Catalog Number	Jaw Length (mm)	Length (in.)
MB350R	50	8 3/4

DERRA-COOLEY Atraumatic Clamp

Catalog Number	Jaw Length (mm)	Length (in.)
FB725	1	6 3/4
R	6	6 7/8
FB726	2	6 7/8
R	1	
FB727	2	
R	7	

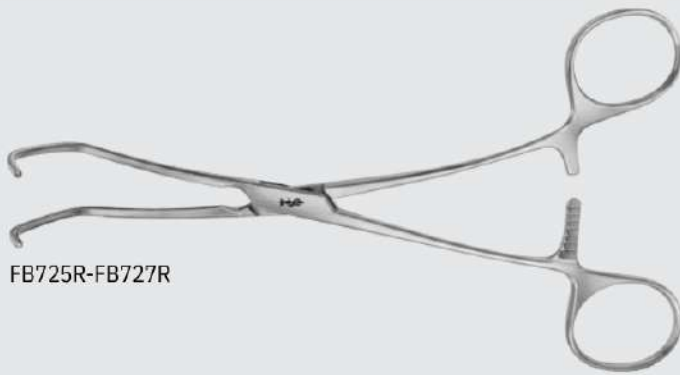

FB725R-FB727R

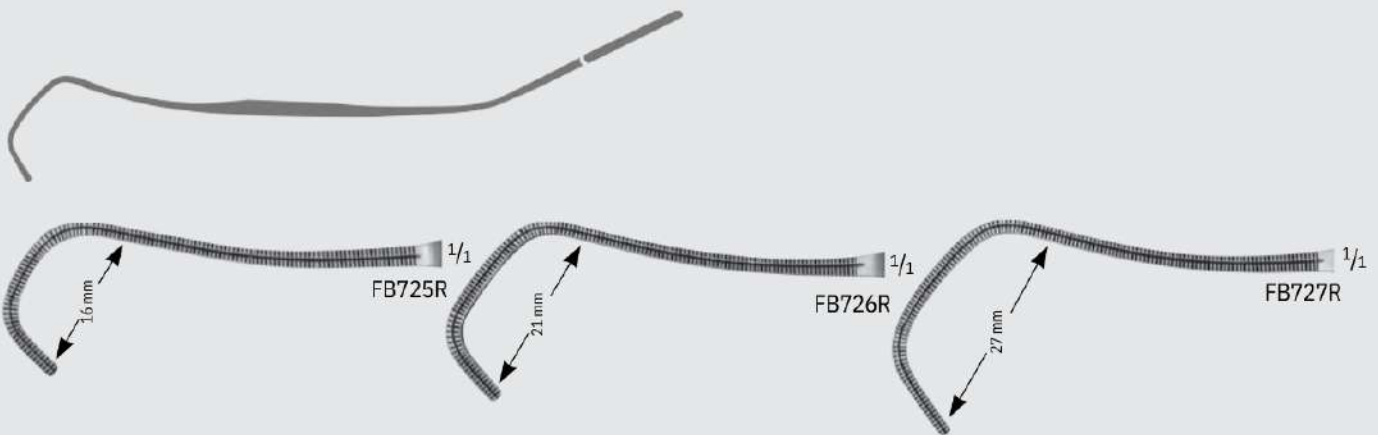

COOLEY Atraumatic Clamp, Spoon Shaped

Catalog Number	Jaw Length (mm)	Length (in.)
FB743R	42	5 3/4

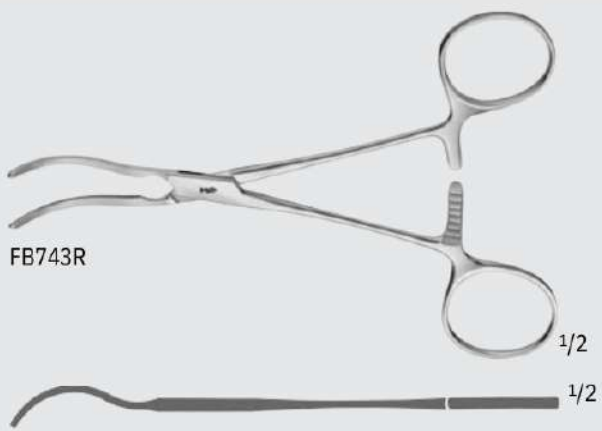

FB743R

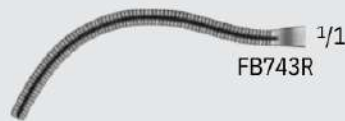

FB743R

COOLEY-SATINSKY Atraumatic Pediatric Clamp

Catalog Number	Jaw Length (mm)	Length (in.)
MB613R	21	5 1/2

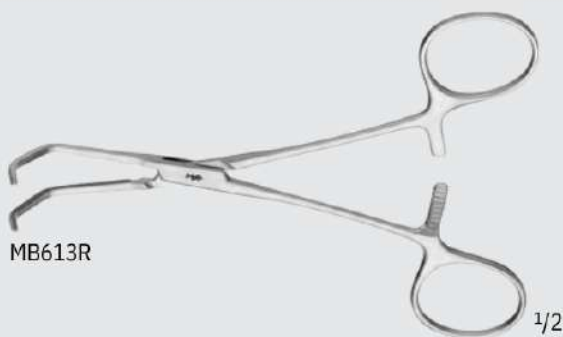

MB613R

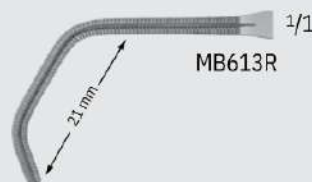

MB613R



INCHES

Cardiovascular

Vascular Clamps



COOLEY Atraumatic Cardiovascular Clamp, Curved

Catalog Number	Jaw Length (mm)	Length (in.)
MB348R	55	8 1/4

MB348R 1/2 MB348R 1/1

HENDREN Atraumatic Cardiovascular Clamp

Catalog Number	Jaw Length (mm)	Length (in.)
MB743R	1	8 1/4
MB744R	3	8 1/2
MB745R	3	8 1/2
MB746R	0	8 3/4
MB747R	3	8 3/4

MB743R-MB747R 1/1

13 mm 50 mm MB743R 1/1

30 mm 50 mm MB744R 1/1

35 mm 55 mm MB745R 1/1

40 mm 55 mm MB746R 1/1

45 mm 60 mm MB747R 1/1

COOLEY Atraumatic Pediatric Anastomosis Clamp, Curved

Catalog Number	Jaw Length (mm)	Length (in.)
FB734R	36	6 3/4
FB735R	44	6 3/4

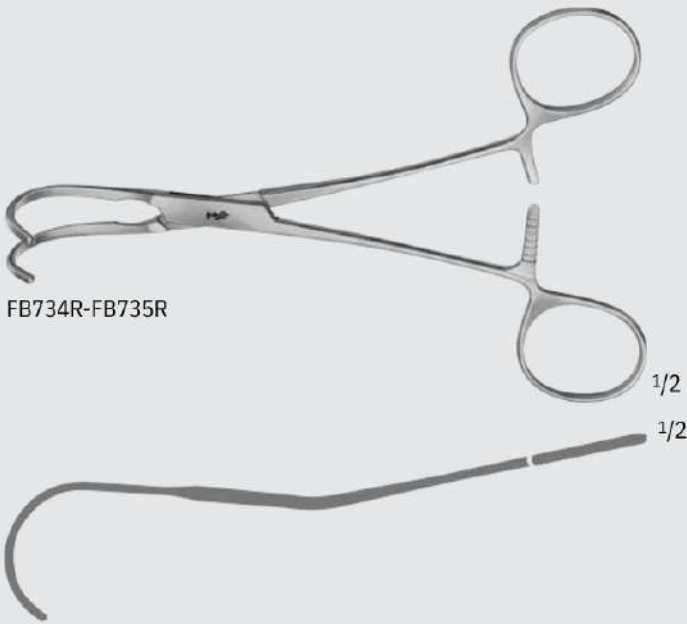

FB734R-FB735R

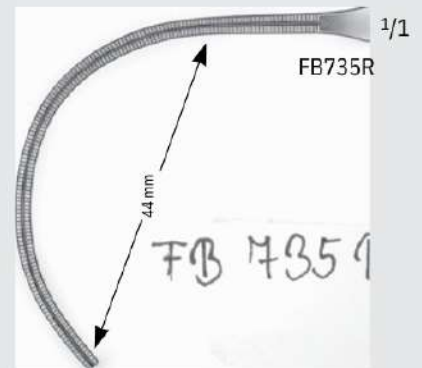
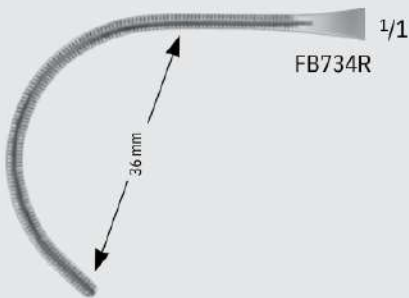

POTTS Anastomosis Clamp

Catalog Number	Jaw Angle	Jaw Length (mm)	Length (in.)
MB547R	90°	40	7 1/4

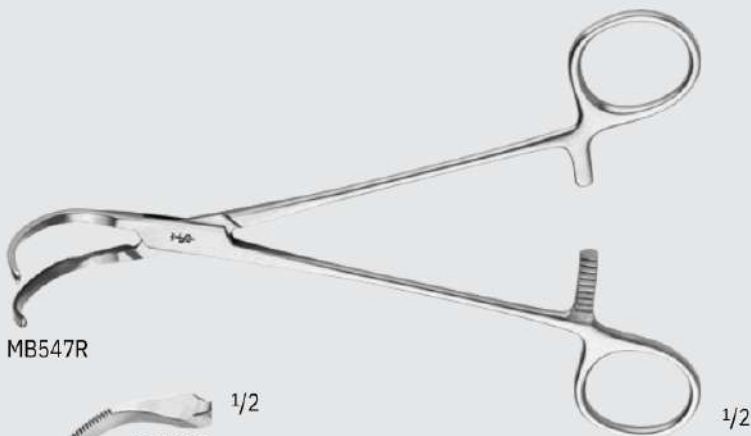

MB547R

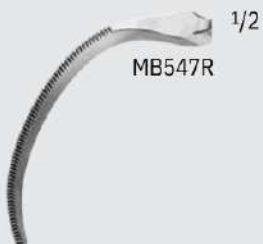

Cardiovascular

Vascular Clamps



COOLEY Atraumatic Carotid and Subclavian Clamp

Catalog Number	Jaw Length (mm)	Length (in.)
FB736	7	7 1/4
R	4	7 3/4
FB737	8	
R	6	

FB736R-FB737R

1/2

1/2

1/1

FB736R

1/1

FB737R

COOLEY Atraumatic Patent Ductus Clamp, Straight Shaft

Catalog Number	Jaw Length (mm)	Jaw	Length (in.)
FB710R	4	STR	6 1/4
FB712R	1	STR	6 3/4
FB713R	5	LIGHT-CVD	7
FB715R	2	S-CVD	7

FB710R-FB715R

1/1

FB710R

1/1

FB712R

1/1

FB713R

1/1

FB715R

COOLEY Atraumatic Patent Ductus Clamp, Angled Shaft

Catalog Number	Jaw Angle	Jaw Length (mm)	Length (in.)
FB711R	ST	4	6 1/4
FB714R	R	1	6 3/4
FB754R	ST	5	6 1/2
FB755R	R	2	6 3/4
FB756R	60°	5	7 1/4

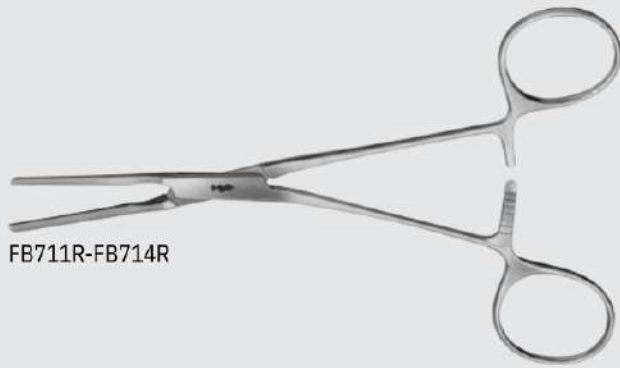

FB711R-FB714R



1/1
FB711R

1/1
FB714R



FB754R-FB756R

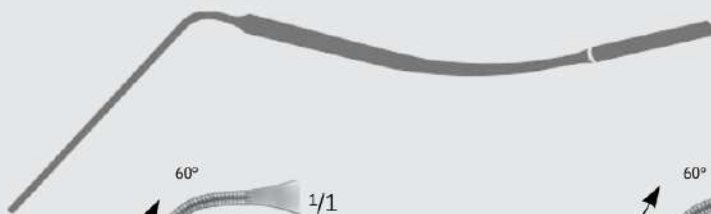

60°
40 mm
1/1
FB754R

60°
52 mm
1/1
FB755R

60°
70 mm
1/1
FB756R



Cardiovascular

Vascular Clamps



FB640R-FB649R, MB580R-MB582R

COOLEY Cava Occlusion Clamp

Catalog Number	Jaw Size (FR)	Length (in.)
FB640R	2	6 1/4
FB641R	0	6 1/4
FB642R	2	7 1/2
MB580R	4	7 1/2
FB644R	2	7 1/2
MB581R	6	7 1/2
MB582R	2	7 1/2
FB647R	8	7 1/2
FB649R	3	7 1/2



FB640R



FB642R



FB644R



MB582R



FB649R

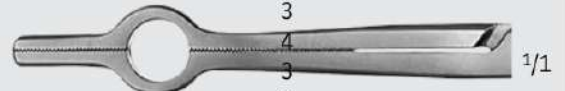

FB641R



MB580R



MB581R



FB647R

0
3
2
3
4
3
6
4
0

COOLEY Atraumatic Pediatric Anastomosis Clamp, Angled Shaft

Catalog Number	Jaw Length (mm)	Length (in.)
FB729	1	6 3/4
R	7	6 1/2
FB721	2	6 1/2
R	5	6 7/8
FB722	2	7
R	8	
FB723	3	
R	3	
FB724	3	
R	6	

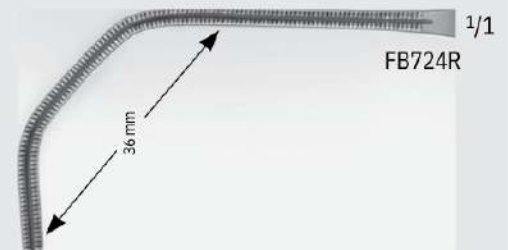
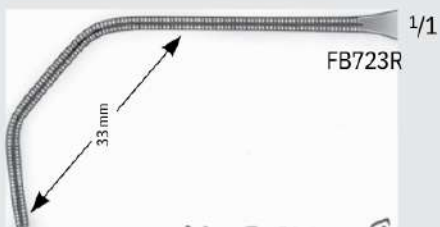
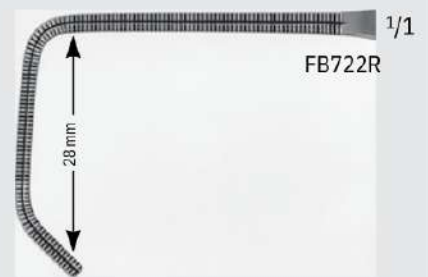
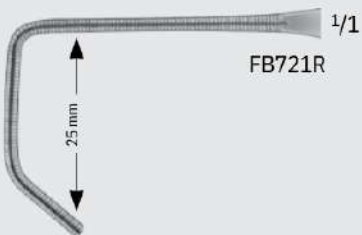
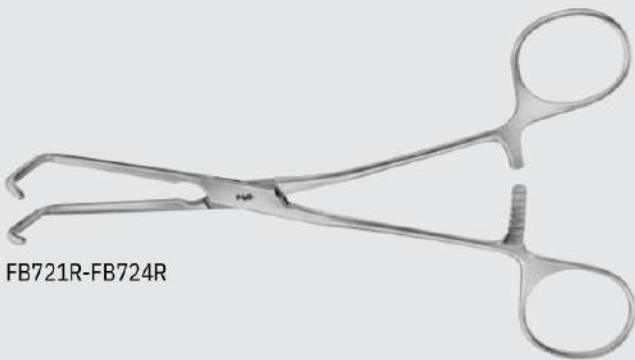
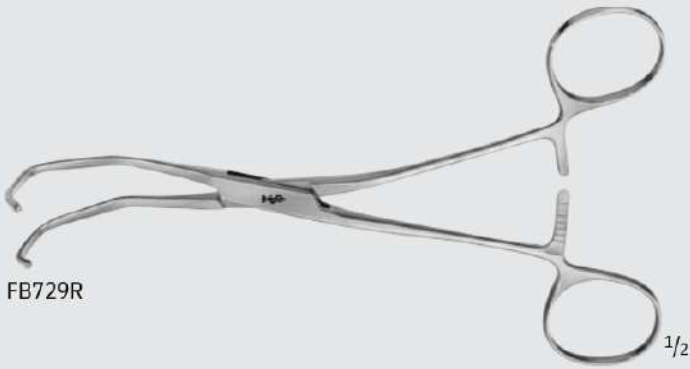

Cardiovascular

Vascular Clamps



COOLEY Atraumatic Pediatric Multi-Purpose Clamp, Angled Shaft

Catalog Number	Jaw Angle	Jaw Length (mm)	Length (in.)
FB717	30°	3	6 1/2
R	°	5	6 1/4
FB718	60°	3	6
R	°	5	
FB719	90°	3	
R	°	7	

COOLEY Atraumatic Pediatric Anastomosis Clamp, Angled Shaft

Catalog Number	Jaw Length (mm)	Length (in.)
FB730R	20	6 7/8

**COOLEY Atraumatic Renal Artery
Clamp, Angled Shaft**

Catalog Number	Jaw Length (mm)	Length (in.)
FB738R	108	10 1/4

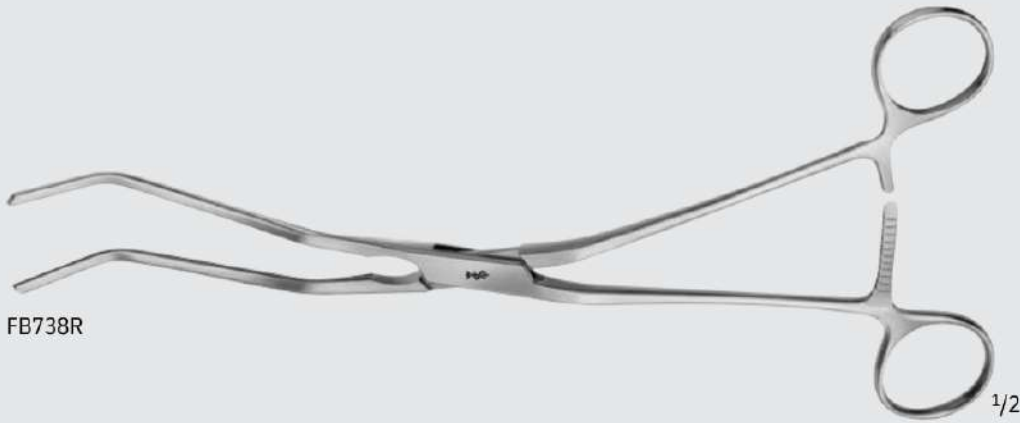

FB738R

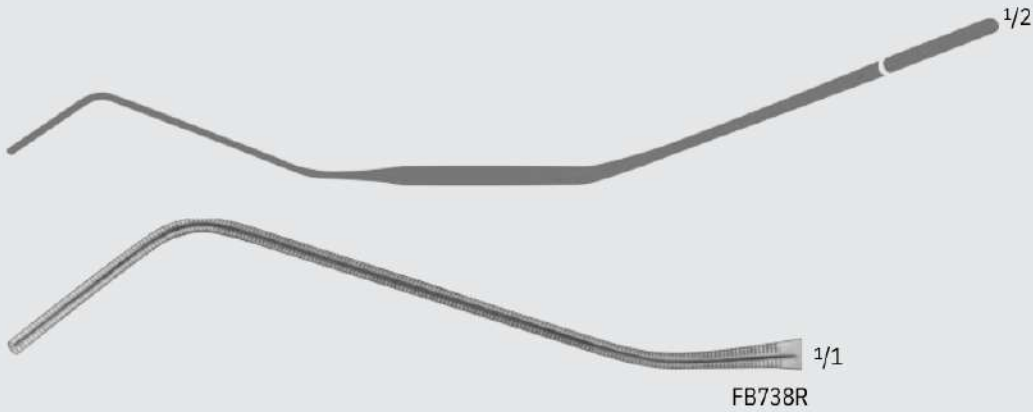

FB738R



INCHES

Cardiovascular

Vascular Clamps

COOLEY Atraumatic Aorta Clamp, Angled Shaft

Catalog Number	Jaw Length (mm)	Length (in.)
MB349R	73	10



MB349R

1/2

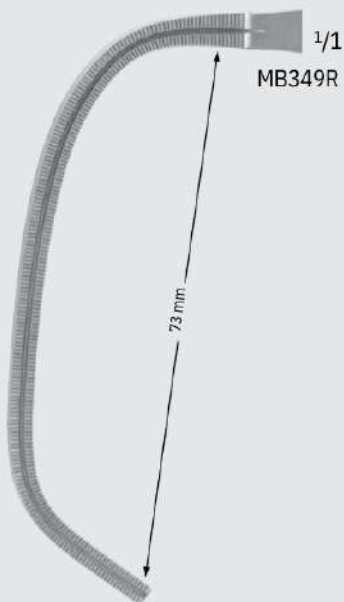

1/1
MB349R

73 mm



COOLEY Tangential Clamp, Calibrated

Catalog Number	Jaw (mm)	Length (in.)
MG456R	20 x 7	7 3/4
MG457R	25 x 8	7 7/8
MG458R	38 x 10	7 7/8

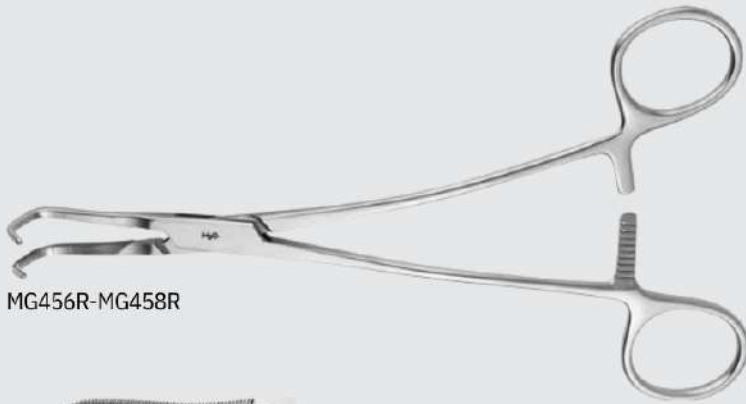

MG456R-MG458R



MG456R



MG457R



MG458R



INCHES

Cardiovascular

Vascular Clamps

COOLEY Atraumatic Forceps, S-Shaped

Catalog Number	Jaw Length (mm)	Length (in.)
FB764R	115	12 1/2

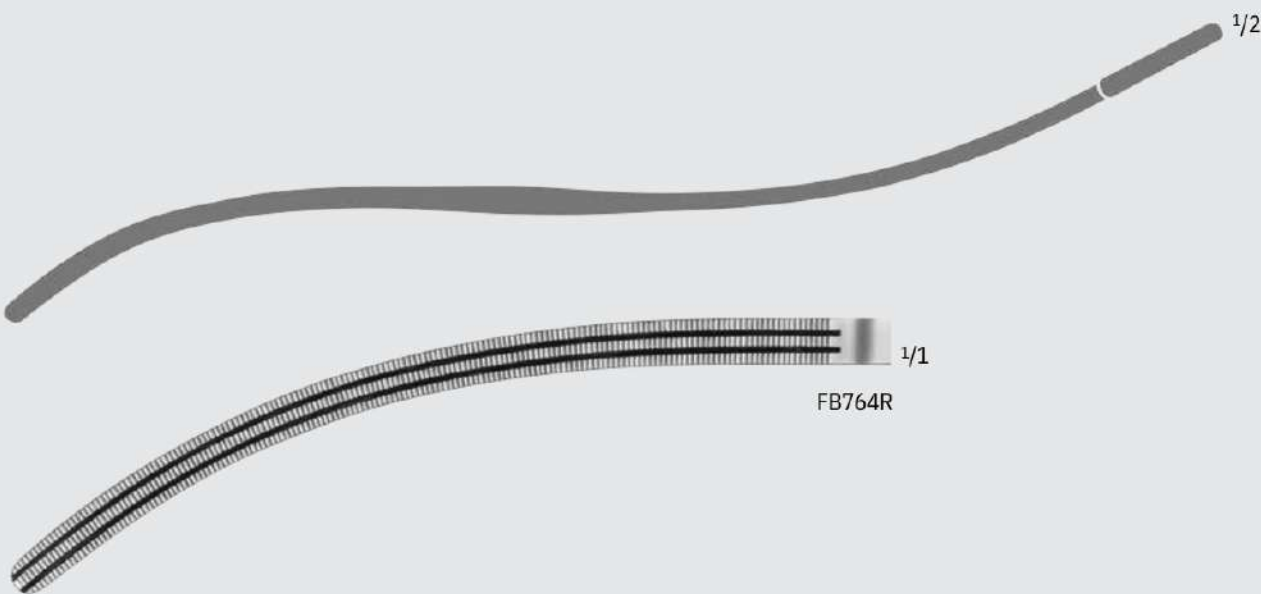
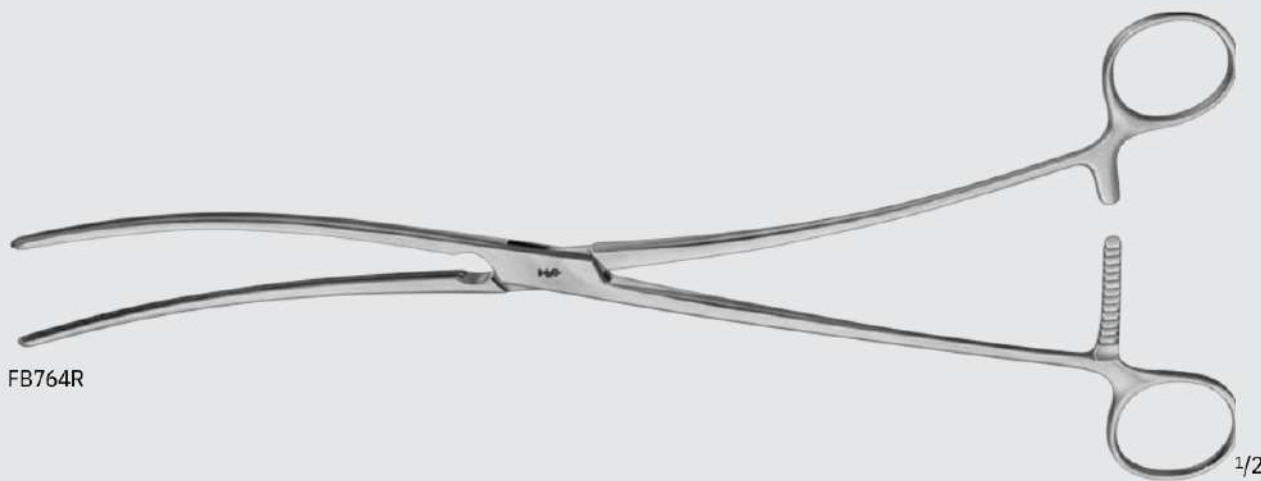

COOLEY Atraumatic Multi-Purpose Clamp, Curved, Angled Shaft, Calibrated

Catalog Number	Jaw Length (mm)	Length (in.)
MB528R	32	8

COOLEY Atraumatic Forceps, Curved, Angled Shaft

Catalog Number	Jaw Length (mm)	Length (in.)
FB765R	82	11 1/4



Cardiovascular

Vascular Clamps

PARRY-COOLEY Atraumatic Forceps

Catalog Number	Jaw Length (mm)	Length (in.)
FB775R	70	11 5/8

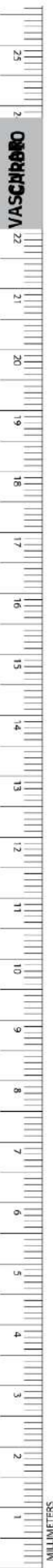
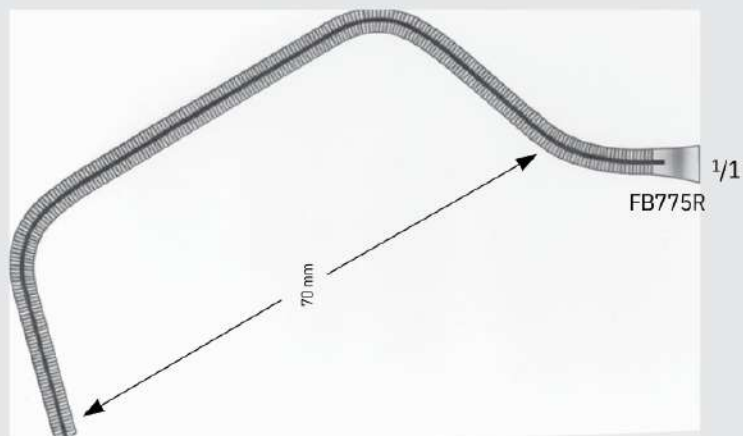
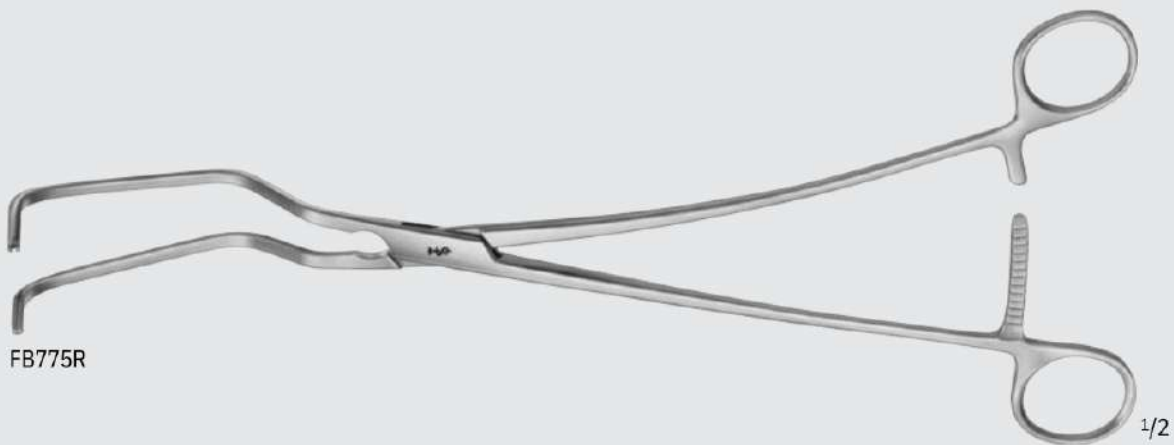

COOLEY Auricular Appendage Clamp

Catalog Number	Jaw	Length (in.)
MG451R	40 x 10	10



Cardiovascular

Vascular Clamps

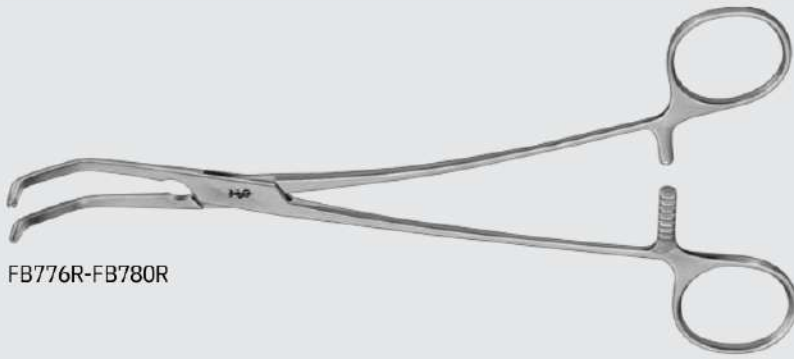

FB776R-FB780R

COOLEY Partial Occlusion Clamp

Catalog Number	Jaw Length (mm)	Length (in.)
FB776	3	8
R	1	10 1/4
FB777	4	10 1/2
R	4	10 1/2
FB778	5	10 3/4
R	0	
FB779	6	
R	3	
FB780	7	
R	8	



1/1
FB776R

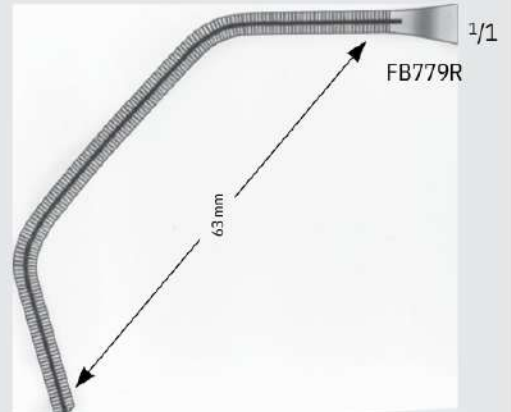

1/1
FB779R

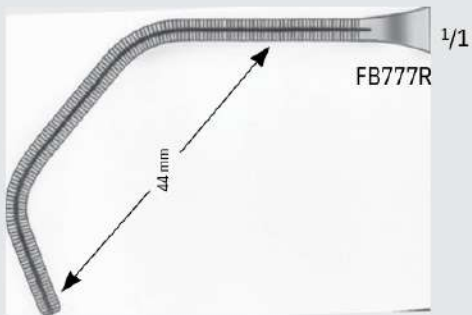

1/1
FB777R

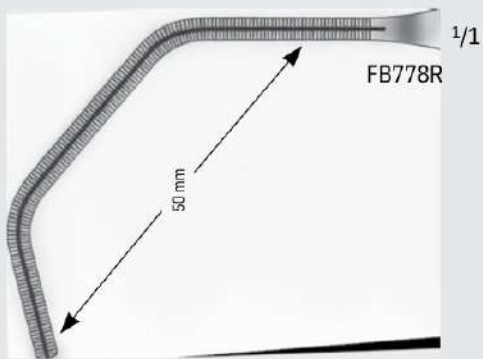

1/1
FB778R

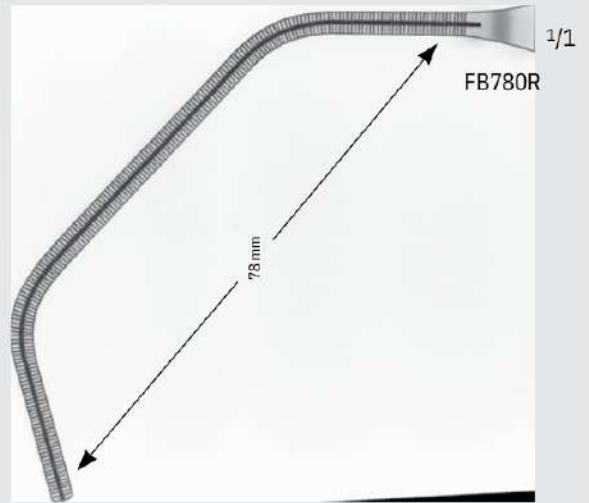

1/1
FB780R



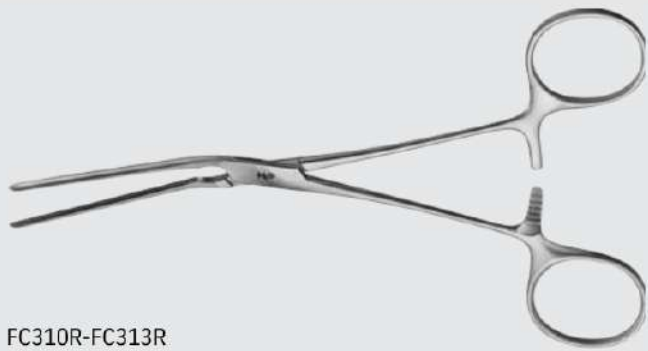

FC310R-FC313R

Atraumatic Multi-Purpose Clamp

Catalog Number	Jaw Length (mm)	Jaw	Length (in.)
FC310	5	STR	6 3/4
R	0	ANG 15°	6 3/4
FC311	5	ANG 30°	6 3/4
R	0	ANG 45°	6 1/4
FC312	5		
R	0		
FC313	5		
R	0		



50 mm



1/1

FC310R

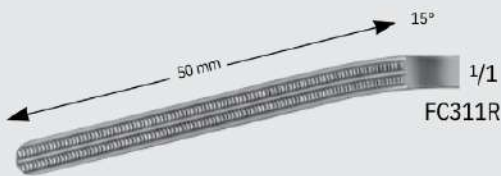

15°

50 mm

1/1

FC311R

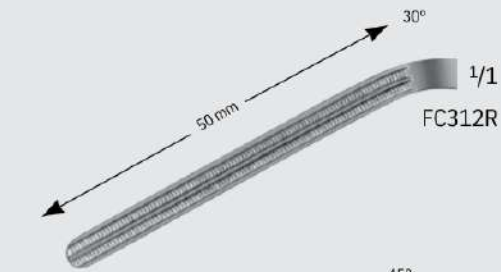

30°

50 mm

1/1

FC312R

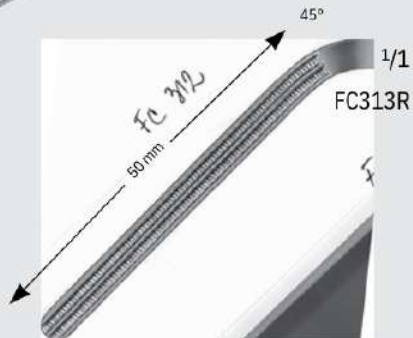

45°

50 mm

1/1

FC313R



INCHES

Cardiovascular

Vascular Clamps



KLINTMALM Liver Transplant Clamp

Catalog Number	Jaw Length (mm)	Length (in.)
MG073R	95	9 3/4

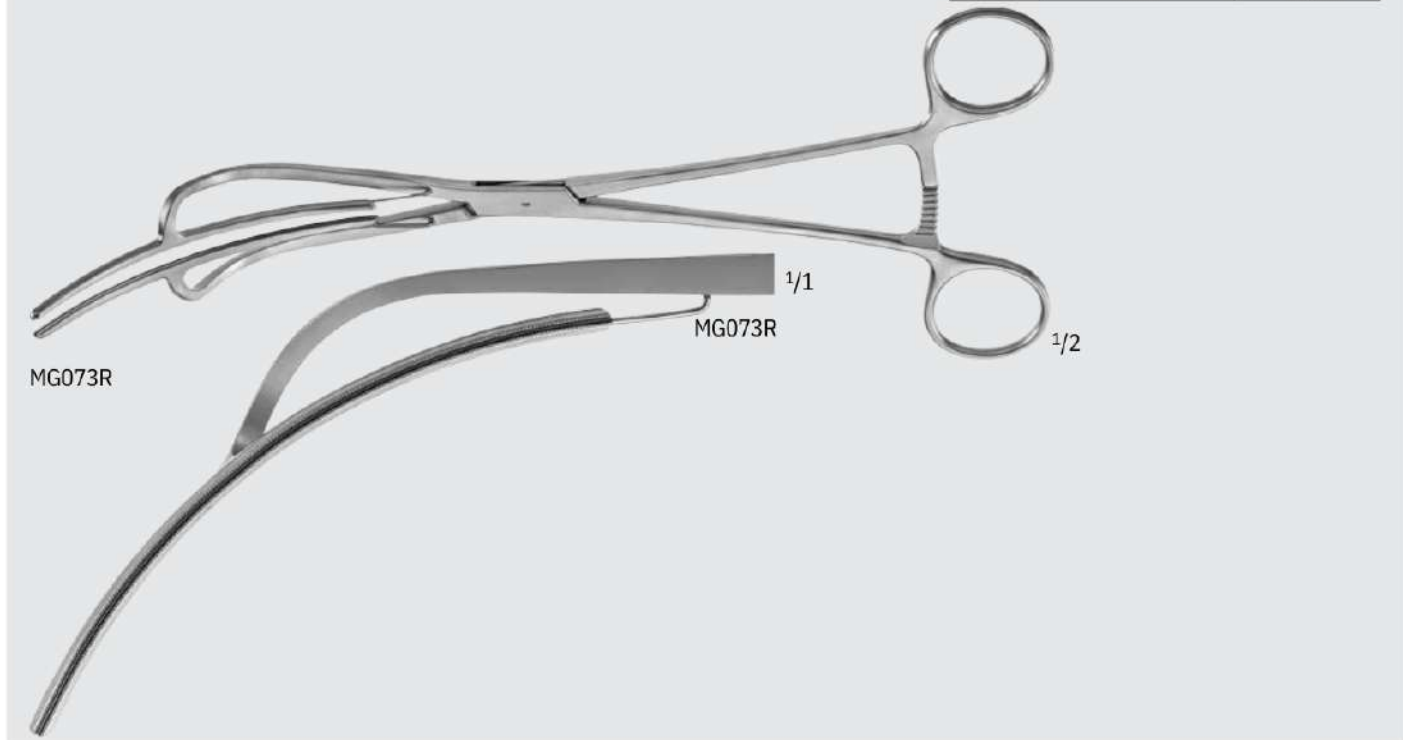

KITZMILLER Clamp

Catalog Number	Jaw	Jaw Length (mm)	Length (in.)
MG012R	ANG LEFT	1	5 1/4
MG013R	ANG RIGHT	0	5 1/4
		1	
		0	

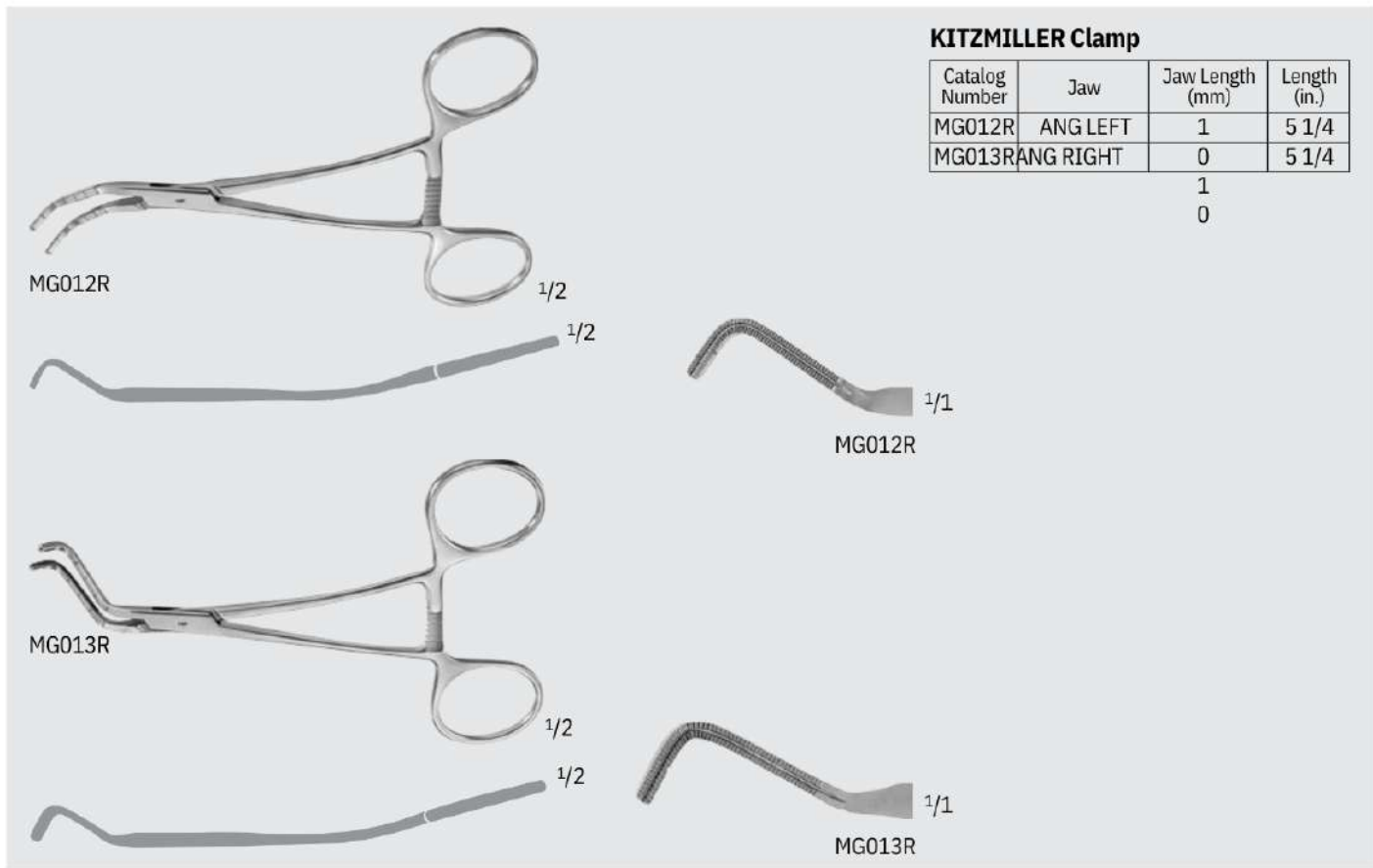

POTTS Liver Clamp W/ Teeth

Catalog Number	Size	Length (in.)
MB481R	SMALL	10
MB482R	MEDIUM	10
MB483R	LARGE	1/4
		10
		5/8



MB481R-MB483R

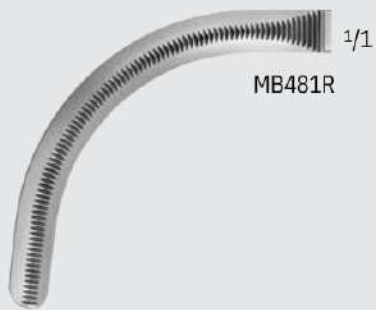

MB481R

1/1



MB482R

1/1

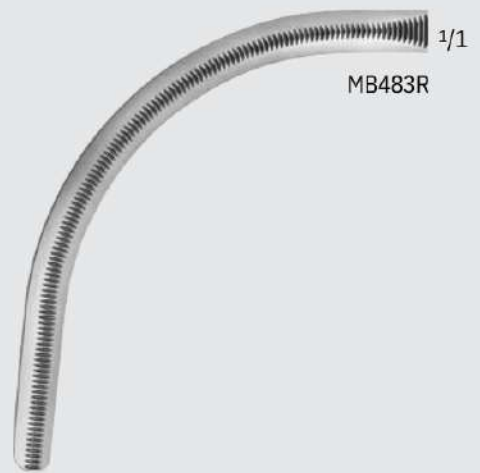

MB483R

1/1



INCHES

Cardiovascular

Vascular Clamps



VASCULAR

PARSONNET Aorta Clamp

Catalog Number	Jaw Length (mm)	Length (in.)
MB671R	2	9 3/8
MB672R	8	9 5/8
MB673R	3	9 5/8
MB674R	2	10

- 3
- 8
- 4
- 5

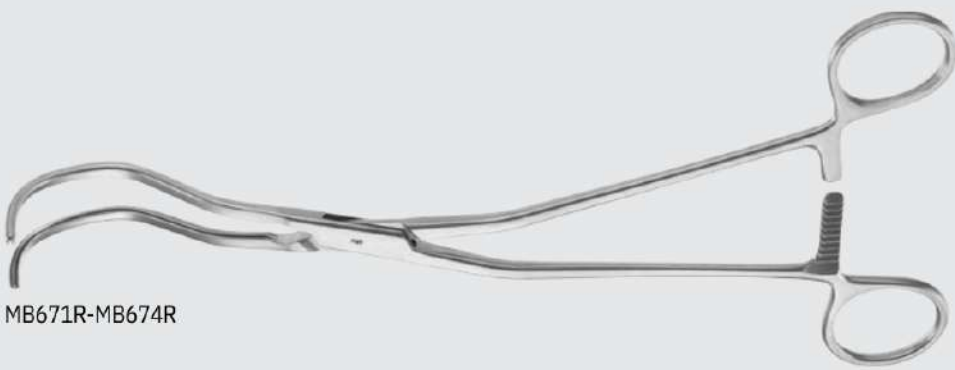

MB671R-MB674R

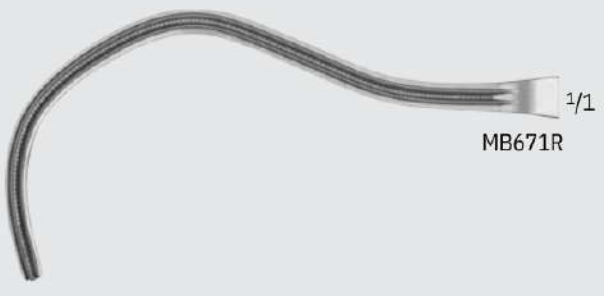

MB671R



MB672R

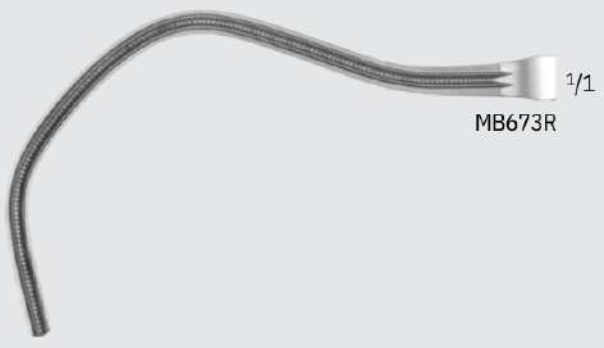

MB673R



MB674R

**JAVID Carotid Artery Bypass
Shunt Clamp**

Catalog Number	Jaw	Length (in.)
MB238R	4 MM RING	6 5/8
MB239R	6 MM RING	7



MB238R-MB239R



MB238R

1/1



MB239R

1/1



Cardiovascular

Bulldog and Micro Vessel Clamps



JOHNS-HOPKINS Apply/Remove Forceps

Catalog Number	Length (in.)
BH018R	9 1/2

Forceps for applying and removing bulldog clamps BH011R - BH031R and FB420R - FB427R

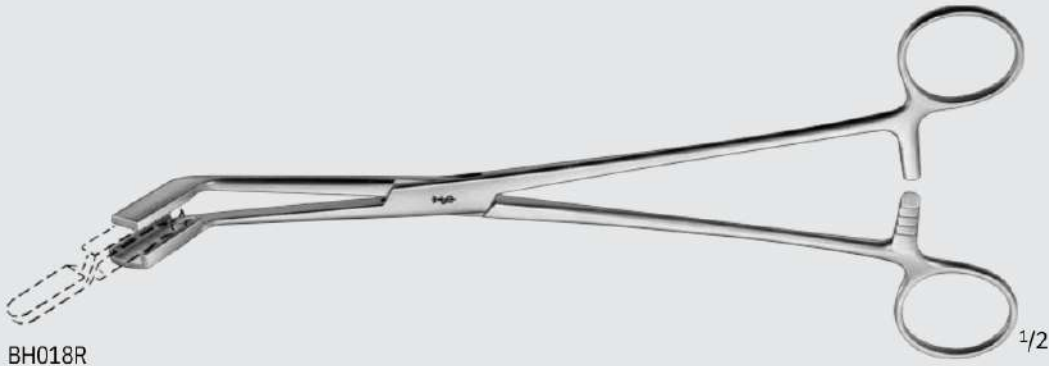

BH018R

JOHNS-HOPKINS Bulldog Clamp

Catalog Number	Jaw	Jaw Length (mm)	Length (in.)
BH011R	CVD	12	1 1/2
BH012R	CVD	17	1 7/8
BH013R	CVD	25	2 1/8
BH014R	CVD	30	2 1/2
BH015R	CVD	33	2 3/4
BH016R	CVD	42	3 1/8
BH017R	CVD	52	3 1/2



BH011R-BH017R

DIEFFENBACH Bulldog Clamp

Catalog Number	Jaw	Jaw Length (mm)	Length (in.)
BH020R	STR	12	1 1/2
BH022R	STR	16	1 7/8
BH026R	STR	16	2 1/8
BH021R	CVD	12	1 1/2
BH023R	CVD	16	1 7/8
BH027R	CVD	16	2 1/8



BH020R



BH026R



BH021R



BH027R



Bulldog Clamp, Lightweight

Catalog Number	Jaw	Jaw Length (mm)	Length (in.)
MG082R	STR	1	1 1/2
MG083R	ANG	8	1 3/8
MG084R	ANG	1	1 1/2
		8	
		2	
		1	



DEBAKEY-HESS Bulldog Clamp

Catalog Number	Jaw	Jaw Length (mm)	Length (in.)
BH030	ANG	2	1 3/8
R	ANG	0	1 1/2
BH031		3	
R		0	



GREGORY-DEBAKEY Bulldog Clamp

Catalog Number	Jaw	Jaw Length (mm)	Length (in.)
MB523R	ANG	70	4 3/4



GREGORY Mini-Bulldog Clamp

Catalog Number	Jaw Length (mm)	Jaw	Length (in.)
FB382R	5	ANG	4 1/8
FB383R	0	ANG	4 3/4
	6		
	5		



INCHES

Cardiovascular

Bulldog and Micro Vessel Clamps



GREGORY Mini-Bulldog Clamp

Catalog Number	Jaw	Jaw Length (mm)	Length (in.)
FB384R	CVD-LEFT	7	4 3/4
FB385R	CVD-RIGHT	0	4 3/4
		7	
		0	

FB384R-FB385R



1/1



1/1

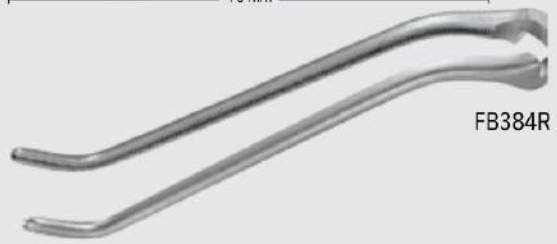

FB385R



1/1

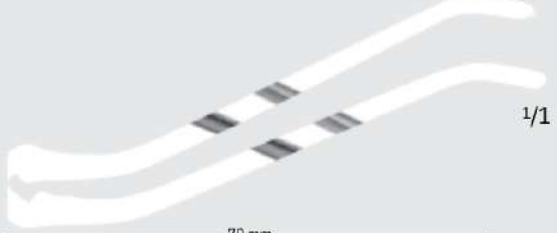

1/1

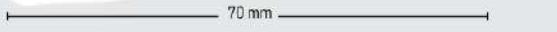

FB385R



FB420R, FB422R, FB424R, FB426R



FB421R, FB423R, FB425R, FB427R

DEBAKEY Atraumatic Mini-Bulldog Clamp

Catalog Number	Jaw	Jaw Length (mm)	Length (in.)
FB420	STR	2	3 1/8
R	STR	0	3 1/2
FB422	STR	3	4 1/8
R	STR	0	5
FB424	CVD	4	3 1/8
R	CVD	5	3 1/4
FB426	CVD	6	3 3/4
R	CVD	5	4 1/2

FB421

R

FB423

R

Atraumatic Mini-Bulldog Clamp

Catalog Number	Jaw	Jaw Length (mm)	Length (in.)
FB328	STR	5	1 3/8
R	STR	4	1 3/4
FB330	CVD	1	1 3/8
R	CVD	9	1 3/4

FB329

R

FB331

R



FB328R



FB330R



FB329R



FB331R



MB741R



MB285R



BH032R



BH034R

DIETRICH Micro Bulldog Clamp

Catalog Number	Jaw	Jaw Length (mm)	Length (in.)
MB741R	STR	1	2
MB285R	STR	6	2 1/4
BH032R	ANG	2	1 7/8
BH034R	ANG	0	1 7/8

1

0

1

3



INCHES

Cardiovascular

Bulldog and Micro Vessel Clamps

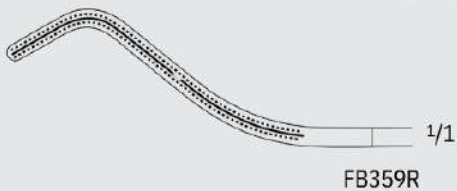
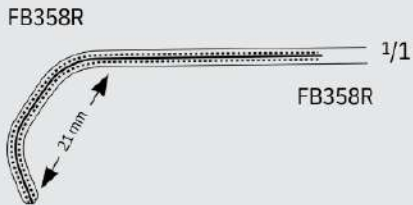
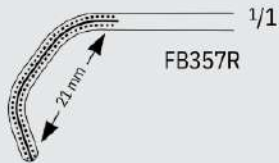

DEBAKEY Atraumatic Mini-Bulldog Clamp

Catalog Number	Jaw Angle	Jaw Length (mm)	Length (in.)
FB352	STR	2	2
R	CVD	0	1 7/8
FB353	MULTI	2	3
R	MULTI	0	4
FB357	S-SHAPED	2	3 3/4
R		1	
FB358		4	
R		2	
FB359		3	
R		8	





FB431R

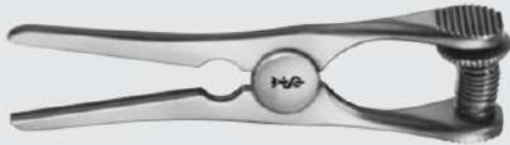

FB432R, FB434R, FB436R



FB433R, FB435R, FB437R

GLOVER Atraumatic Mini-Bulldog Clamp

Catalog Number	Jaw Angle	Jaw Length (mm)	Length (in.)
FB431	75°	20	2
R	STR	25	2 3/4
FB432	STR	40	3 3/4
R	STR	60	4 1/2
FB434	CVD	25	2 1/2
R	CVD	40	3 1/2
FB436	CVD	60	4 1/4

R
FB433
R
FB435
R
FB437
R



MB737R-MB740R



MB586R-MB589R

COOLEY Atraumatic Bulldog Clamp

Catalog Number	Jaw	Jaw Length (mm)	Length (in.)
MB737R	STR	2	2
MB738R	STR	0	2 1/2
MB739R	STR	3	3 1/4
MB740R	STR	0	5
MB586R	CVD	4	1 3/4
MB587R	CVD	5	2 1/2
MB588R	CVD	6	3 1/8
MB589R	CVD	0	4 3/4

4
4
6
4
7
5
6
0



Cardiovascular

Bulldog and Micro Vessel Clamps



FB370R

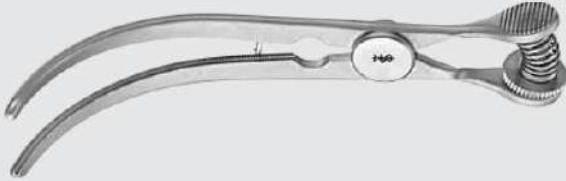

FB374R-FB376R



FB377R

GLOVER Atraumatic Bulldog Clamp

Catalog Number	Jaw	Jaw Length (mm)	Length (in.)
FB370	STR	2	2
R	CVD	5	1 1/2
FB374	CVD	2	2 3/8
R	CVD	0	3
FB375	CVD	3	4 3/4
R		0	
FB376		4	
R		5	
FB377		5	
R		5	

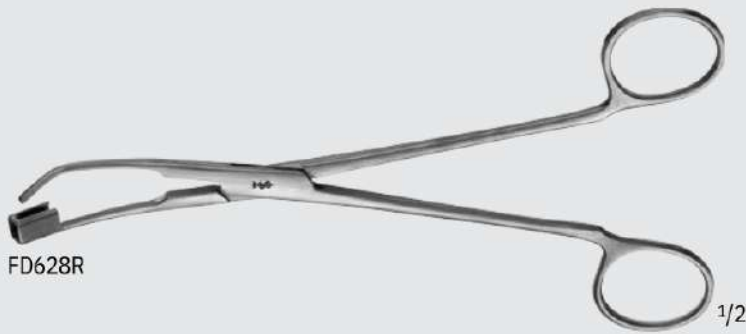

FD628R

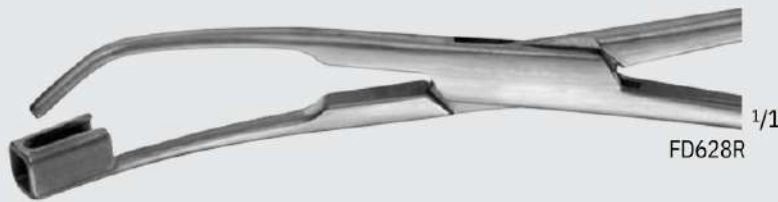

FD628R

SCHWARTZ Apply/Remove Forceps

Catalog Number	Length (in.)
FD628R	7 1/2



FD622R



FD623R



FD624R

SCHWARTZ Micro-Vessel Clamp, Cross-Serrated

Catalog Number	Jaw	Jaw Length (mm)	Closing Force	Length (in.)
FD622R	STR	8	400	1
FD623R	25°	8	G	1
FD624R	45°	8	400	1

G
400
G

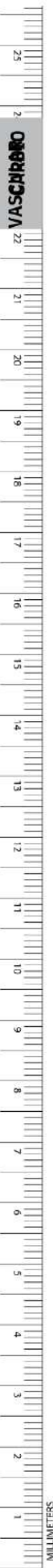



1/1

FE010K, FE020K



1/1

FE010K, FE020K



1/1

FE011K, FE021K



1/1

FE011K, FE021K



1/1

FE012K, FE022K



1/1

FE012K, FE022K



1/1

FE013K, FE023K



1/1

FE013K, FE023K



1/1

FE014K, FE024K



1/1

FE014K, FE024K

MUELLER Atraumatic Micro-Vessel Clamp

Catalog Number	Jaw	Closing Force
FE010	STR	50
K	STR	G
FE020	FULL-CVD	80
K	FULL-CVD	G
FE011	CVD-TIP	50
K	CVD-TIP	G
FE021	ANG	80
K	ANG	G
FE012	LAT-ANG	50
K	LAT-ANG	G
FE022		80
K		G
FE013		50
K		G
FE023		80
K		G
FE014		50
K		G
FE024		80
K		G



1/1

FE005K



1/1

FE005K

MUELLER Ligature Forceps

Catalog Number	Jaw
FE005K	STR



Cardiovascular

Bulldog and Micro Vessel Clamps



FE031S, FE041S



FE032S, FE042S



FE030S, FE040S



FE034S, FE044S

MUELLER Alpha Vessel Clamp

Catalog Numbe	Jaw	Closing Force
FE031	SLIGHT-CVD	250
S	SLIGHT-CVD	G
FE041	CVD	350
S	CVD	G
FE032	ANG	250
S	ANG	G
FE042	KNEE-BENT	350
S	KNEE-BENT	G

FE030	250
S	G
FE040	350
S	G
FE034	250
S	G
FE044	350
S	G



NABATOFF Vein Stripper Set

Catalog Number	Description
FB031R	METAL CASE
FB040R	HANDLE
FB033	PLASTIC PROBE TIP
FB034R	METAL PROBE TIP, 3 MM
FB035R	METAL OLIVE, 6 MM
FB036R	METAL OLIVE, 9 MM
FB037R	METAL OLIVE, 12 MM
FB038R	METAL OLIVE, 15 MM



FB033



FB034R



FB035R



FB036R



FB037R



FB038R



FB040R

NABATOFF Mini Vein Stripper Set

Catalog Number	Description
FB031	METAL CASE
R	METAL OLIVE, 3 MM
FB053	METAL OLIVE, 4 MM
R	METAL OLIVE, 5 MM



FB053R



FB054R



FB055R

FB054
R
FB055
R



Cardiovascular

Vessel Instruments



VARADY Varix Dissector, Double Ended

Catalog Number	Tip Size (mm)	Length (in.)
FB120R	0.30 / 0.30	7

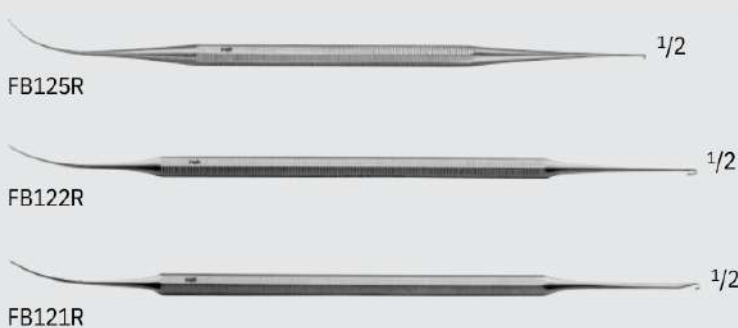

VARADY Varix Extractor, Double Ended W/ Hook

Catalog Number	Tip Size (mm)	Length (in.)
FB125	0.25 / 0.40	6 3/4
R	0.75 / 0.60	7
FB122	0.75 / 1.2	7
R		
FB121		
R		



VARADY Mini-Varix Extractor, Double Ended W/ Hook

Catalog Number	Tip Size (mm)	Length (in.)
FB126R	0.35 / 0.50	6 3/4



VARADY Micro Spatula, Double Ended

Catalog Number	Tip Size (mm)	Length (in.)
FB124R	0.35 / 0.25	6 7/8



FB108R-FB117R

○ 1/1
FB108R

○ 1/1
FB109R

○ 1/1
FB110R

○ 1/1
FB112R

1/1
FB113R

1/1
FB114R

○ 1/1
FB115R

○ 1/1
FB116R

1/1
FB117R



FB119R

Endarterectomy Stripper

Catalog Number	Tip Size (mm)	Length (in.)
FB108R221	3/4	FB109R321 3/4
FB110R421	3/4	FB112R621 3/4
FB113R721	3/4	FB114R8.521 3/4
FB115R1021	3/4	FB116R1221 3/4
FB117R1421	3/4	FB119R-4 1/4

FB119R is the handle for FB108R-FB117R



INCHES

Cardiovascular

Specialty CV/Thoracic Instruments



FB150R-FB151R



1/1

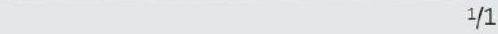

1/1

FB150R-FB151R

Vascular Spatula, Blunt, 3 mm

Catalog Number	Length (in.)
FB150R	7 1/4
FB151R	8 1/2



MB063R

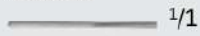

1/1

MB063R

JACOBSON Endarterectomy Spatula

Catalog Number	Length (in.)
MB063R	7

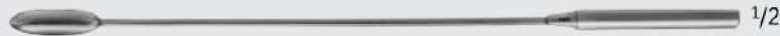

FB160R-FB172R, MG008R-MG010R



1/1

FB160R

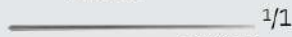

1/1

FB161R



1/1

FB162R



1/1

FB163R

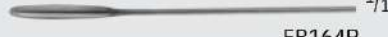

1/1

FB164R



1/1

FB165R



1/1

FB166R



1/1

FB167R



1/1

FB168R



1/1

FB169R

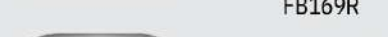

1/1

MG008R



1/1

FB170R



1/1

MG009R



1/1

FB172R

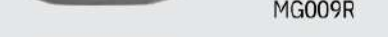

1/1

MG010R

DEBAKEY Vascular Dilator, Malleable

Catalog Number	Tip Size (mm)	Length (in.)
MG011R	SET OF 12	-
MG055R	SET OF 5	-
FB160R	0.5	7 1/2
FB161R	1.0	7 1/2
FB162R	1.5	7 1/2
FB163R	2.0	7 1/2
FB164R	2.5	7 1/2
FB165R	3.0	7 1/2
FB166R	3.5	7 1/2
FB167R	4.0	7 1/2
FB168R	4.5	7 1/2
FB169R	5.0	7 1/2
MG008R	6.0	7 1/2
FB170R	7.0	7 1/2
MG009R	8.0	7 1/2
FB172R	9.0	7 1/2
MG010R	10.0	7 1/2

MG011R Includes:

1 Dilator of each FB161R-165R, FB167R, FB169R, MG008R, FB170R, MG009R, FB172R, MG010R

MG055R Includes:

1 Dilator of each FB161R-165R

VASCULAR



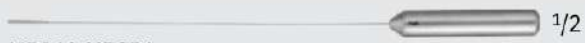

MB246-MB254

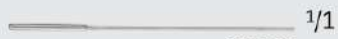

MB246



MB247

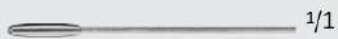

MB248



MB249



MB250

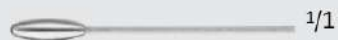

MB251



MB252

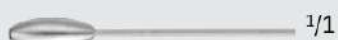

MB253



MB254



MB255

GARRETT Vascular Dilator

Catalog Number	Tip Size (mm)	Length (in.)
MB245	COMPLETE SET	5 1/2
MB246	1.0	5 1/2
MB247	1.5	5 1/2
MB248	2.0	5 1/2
MB249	2.5	5 1/2
MB250	3.0	5 1/2
MB251	3.5	5 1/2
MB252	4.0	5 1/2
MB253	4.5	5 1/2
MB254	5.0	5 1/2
MB255	TUBE	5 1/2

MB245 Includes:

1 Dilator of each MB246-MB254

MB255:

Tube for GARRETT Vascular Dilators

MB245-MB254

Cardiovascular

Specialty CV/Thoracic Instruments



VASCULAR

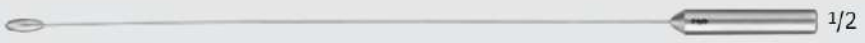

MB257-MB265

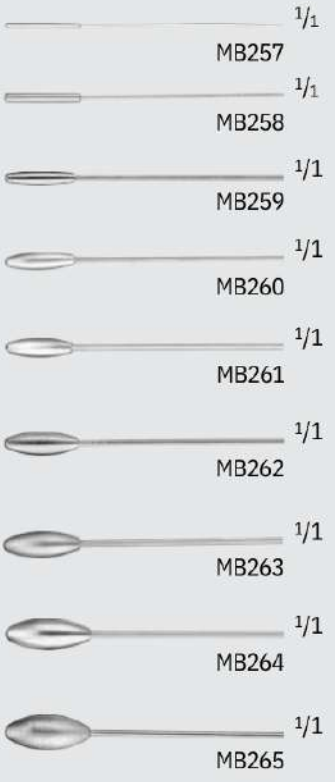

MB266

GARRETT Vascular Dilator

Catalog Number	Tip Size (mm)	Length (in.)
MB256	COMPLETE SET	8 1/2
MB257	1.0	8 1/2
MB258	1.5	8 1/2
MB259	2.0	8 1/2
MB260	2.5	8 1/2
MB261	3.0	8 1/2
MB262	3.5	8 1/2
MB263	4.0	8 1/2
MB264	4.5	8 1/2
MB265	5.0	8 1/2
MB266	TUBE	8 1/2

MB256 Includes:
 1 Dilator of each MB257-MB265
 MB266:
 Tube for GARRETT Vascular Dilator



MG051R-MG054R

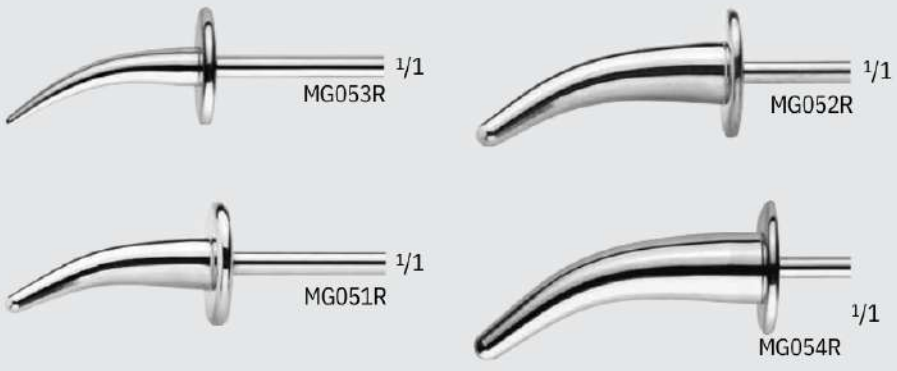

Aortic Arch Dilator

Catalog Number	Tip Size (mm)	Length (in.)
MG053R	5	8
MG051R	6	8
MG052R	8	8
MG054R	9.5	8

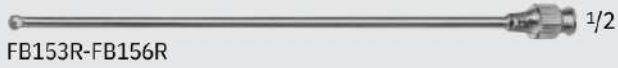

FB153R-FB156R



FB153R



FB154R



FB155R



FB156R

SCHMID Vessel Irrigation Cannula, Silver Plated

Catalog Number	Tip Size (mm)	Length (in.)
FB153R	3	6
FB154R	4	6
FB155R	5	6
FB156R	6	6



MD610-MD611

Heparin Needle

Catalog Number	Gauge	Length (in.)
MD610	13	3 1/2
MD611	18	3 3/4

MD610
MD611



MB601R

ZANGER Heparin Cannula, Malleable

Catalog Number	Tip Size (mm)	Length (in.)
MB601R	3.5	2 3/4



MB602R

IMA Heparin Cannula, Malleable

Catalog Number	Tip Size (mm)	Length (in.)
MB602R	1.5	2 1/8



MB634R

Luer Lock Adapter

Catalog Number	Length (in.)
MB634R	1 1/2

Cardiovascular

Specialty CV/Thoracic Instruments



FK340R

1/1

1/1

FK340R



FK341R

1/1

1/1

FK341R

FARABEUF Elevator

Catalog Number	Tip Size (mm)	Blade Shape	Length (in.)
FK340	12.5	STR	5 3/4
R	12.5	CVD	5 1/4

FK341
R



FK344R

1/1

1/1

FK344R



FK345R

1/1

1/1

FK345R

FARABEUF-COLLIN Elevator

Catalog Number	Tip Size (mm)	Blade Shape	Length (in.)
FK344	1	STR	6 1/4
R	1	CVD	6 1/4

FK345
R





MATSON Rib Stripper/Elevator

Catalog Number	Length (in.)
MB812R	8 3/4

MB812R

1/2



LAMBOTTE Rib Elevator

Catalog Number	Tip Size (mm)	Length (in.)
FK355	5	8 1/2
R	10	8 1/2
FK356	15	8 1/2
R	20	8 1/2
FK357	25	8 1/2

FK355R-FK359R

1/2

1/1

1/1

FK355R-FK359R

Cardiovascular

Specialty CV/Thoracic Instruments



FK381R-FK387R



FK381R



FK382R

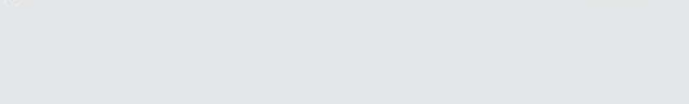

FK383R

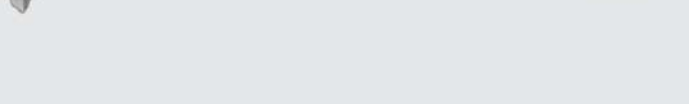

FK384R

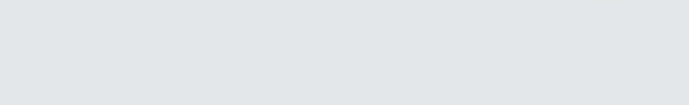

FK387R

SEMB Elevator

Catalog Number	Tip Size (mm)	Length (in.)
FK381	1	7 1/2
R	2	9
FK382	1	9
R	2	9
FK383	1	9
R	3	
FK384	1	
R	3	
FK387	1	
R	5	

DOYEN Elevator

Catalog Number	Blade End	Blade Shape	Length (in.)
FK400R	PEDIATRIC	LEFT-CVD	6 7/8
FK402R	ADULT	LEFT-CVD	6 7/8
FK401R	PEDIATRIC	RIGHT-CVD	6 7/8
FK403R	ADULT	RIGHT-CVD	6 7/8
FK408R - LEFT-CVD	FK409R -		9 1/2
RIGHT-CVD			9 1/2



FK400R-FK402R

1/2

1/1

FK400R

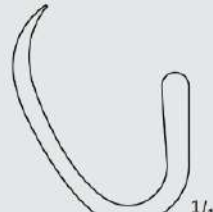

1/1

FK402R



FK401R-FK403R

1/2

1/1

FK401R

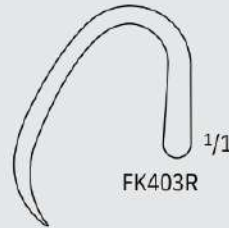

1/1

FK403R



FK408R

1/2

1/1

FK408R



FK409R

1/2

1/1

FK409R



INCHES

Cardiovascular

Specialty CV/Thoracic Instruments



FK420R

ALEXANDER Elevator

Catalog Number	Tip Size (mm)	Length (in.)
FK420R	12	8 1/4

1/1

1/1

1/1

1/1
FK420R



FB870R

Rib Shears

Catalog Number	Blade	Length (in.)
FB870R	S/B	9

1/2



FB873R

GLUCK Rib Shears

Catalog Number	Length (in.)
FB873R	7 1/2

1/2



FB878R

BETHUNE Rib Shears

Catalog Number	Length (in.)
FB878R	13 3/8

1/3





FB881R-FB882R

SAUERBRUCH Rib Shears

Catalog Number	Size	Length (in.)
FB881R	PEDIATRIC	9 1/2
FB882R	ADULT	10 5/8



FB890R

1/3

GIERTZ-STILLE Rib Shears

Catalog Number	Length (in.)
FB890R	9 3/4



MG094R

1/3

SWEET Sternum Punch

Catalog Number	Length (in.)
MG094R	10

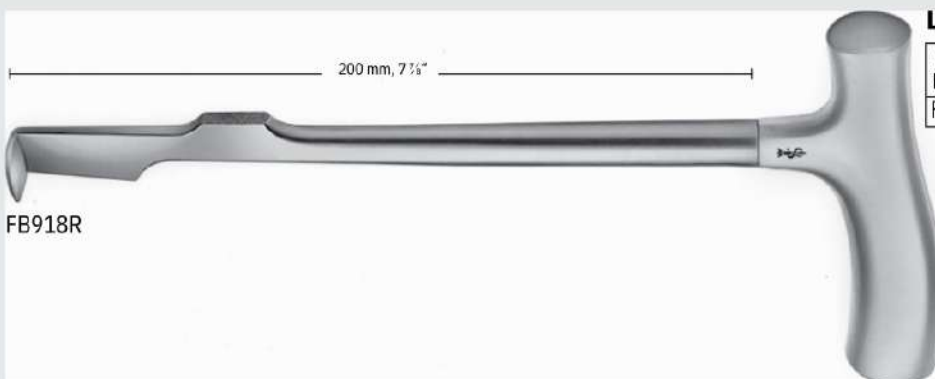

FB918R

200 mm, 7 7/8"

LEBSCHKE Sternum Chisel

Catalog Number	Length (in.)
FB918R	9 3/4

1/2



INCHES

Cardiovascular

Specialty CV/Thoracic Instruments

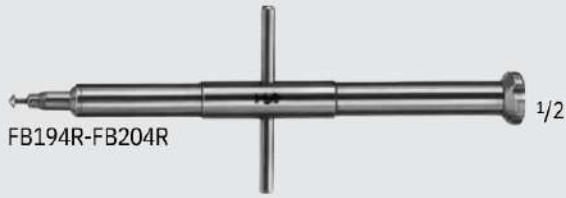

Aorta Punch

Catalog Number	Tip Size (mm)	Length (in.)
FB201	3.	5 1/2
R	0	5 1/2
FB202	3.	5 1/2
R	5	5 1/2
FB194	4.	5 1/2
R	0	5 1/2
FB203	4.	5 1/2
R	5	
FB195	5.	
R	0	
FB204	5.	
R	5	
FB196	6.	
R	0	

Valvulotome

Catalog Number	Tip	Length (in.)
MB360R	ANTEGRADE	6 3/8
MB358R	RETROGRADE	9 1/2
MB359R	RETROGRADE	12 1/4

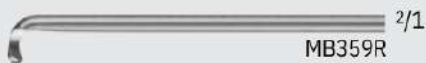

JENKNER Tunnelling Instruments

Catalog Number	Diameter (mm)	Description	Length (in.)
FC004R	12	TUNNELLING TUBE W/ CONICAL TIP	16
FC005R	12	TUNNELLING TUBE W/ CONICAL TIP	20
FC014R	14	TUNNELLING TUBE W/ CONICAL TIP	16
FC015R	14	TUNNELLING TUBE W/ CONICAL TIP	20
FC034R	5	FORCEPS F/ FC004R/ FC014R TUNNELLING	16
FC035R	5	FORCEPS F/ FC005R/ FC015R HANDLE	20
FC030	-	F/ TUNNELLING TUBES	-

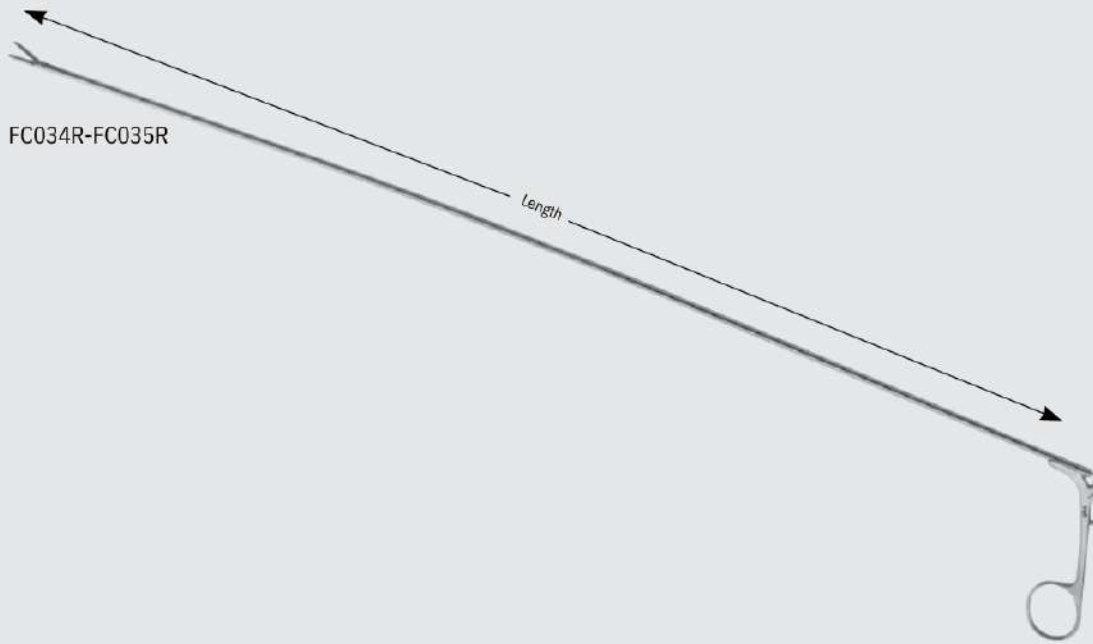

FC030

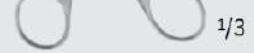

1/3



Cardiovascular

Specialty CV/Thoracic Instruments

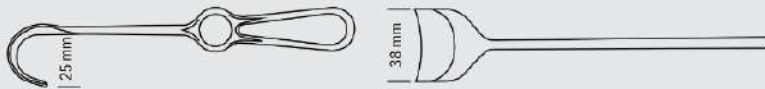

Dimensions for blade size of retractors
 1st number = depth Example: 25 x 38 mm
 2nd number = width

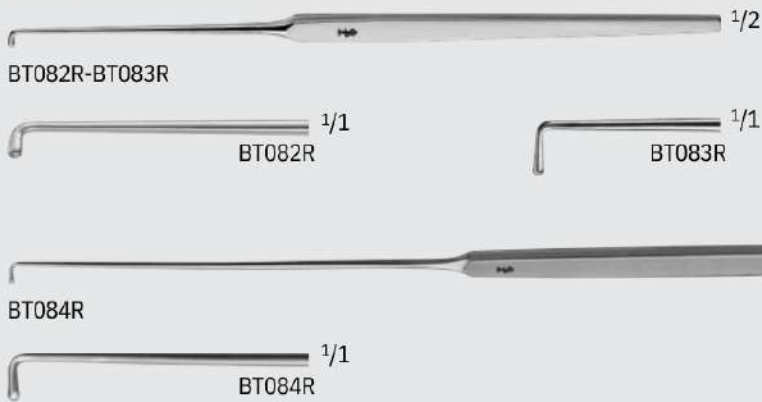

CUSHING Vessel Hook

Catalog Number	Tip Size (mm)	Tip	Length (in.)
BT082	1 x 4	BLUN	7 1/2
R	1 x 7	T	7 1/2
BT083	1 x 6	BLUN	11
R		T	
BT084		BLUN	
R		T	



CRILE Vessel Hook

Catalog Number	Tip Size (mm)	Tip	Length (in.)
BT080R	1.5 x 9	BLUNT	7 7/8



DANDY Nerve Hook

Catalog Number	Tip Size (mm)	Tip	Length (in.)
MD562	1 x 8	BLUNT	8 3/4

VASCULAR

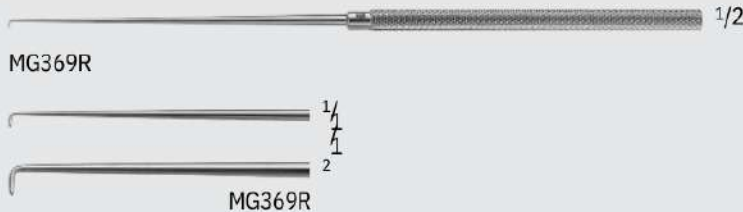

MG369R

MG369R

MG369R

MG369R

1/2

1/4

1/4

2

Blunt Hook

Catalog Number	Tip Size (mm)	Tip	Length (in.)
MG369R	2	RND	7

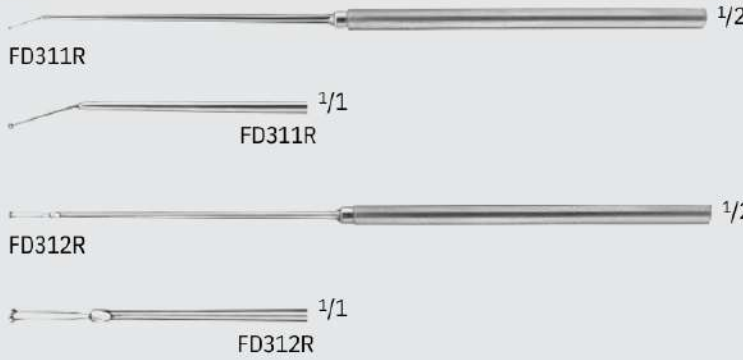

FD311R

FD311R

FD311R

FD312R

FD312R

1/2

1/1

1/1

1/2

1/1

JACOBSON Probe

Catalog Number	Tip	Length (in.)
FD311R	RANG, SINGLE PROBE	7 1/4
FD312R	STR, DOUBLE PROBE	7 1/4

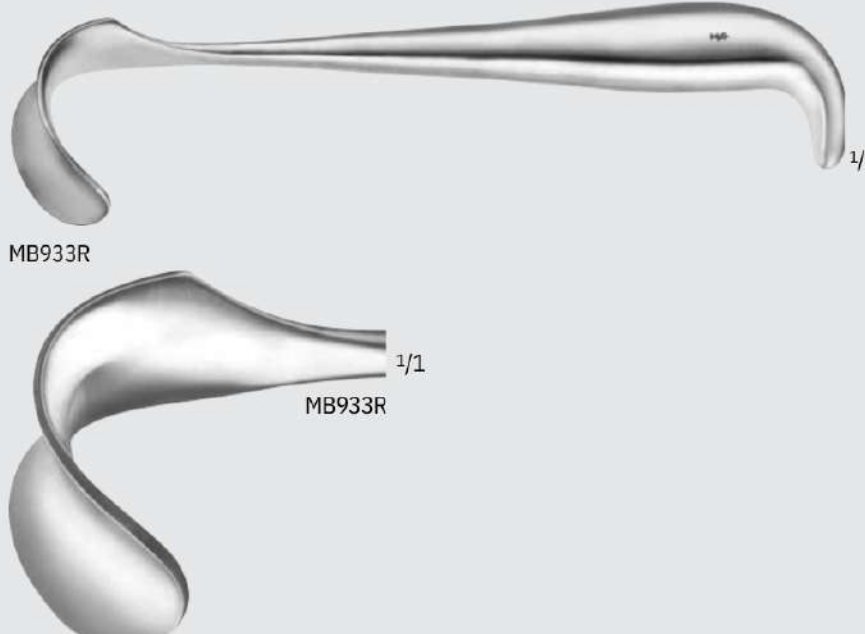

MB933R

MB933R

MB933R

1/2

1/1

BREWSTER Retractor

Catalog Number	Blade Size (mm)	Blade	Length (in.)
MB933R	25 x 45	CVD CONVEX	9



Cardiovascular

Retractors



BV014R



PARSONNET Epicardial Retractors

Catalog Number	Blade End	Tip	Length (in.)
BV014R	3 x 3 PRONGS	SHARP	2



BV021R-BV024R

IMA Epicardial Retractor

Catalog Number	Blade End	Tip	Length (in.)
BV021R	3 x 3 PRONGS	SHARP	1
BV022R	3 x 3 PRONGS	SHARP	1 1/4
BV023R	3 x 3 PRONGS	SHARP	1 1/2
BV024R	3 x 3 PRONGS	SHARP	2



MB047R-MB048R, MB700R-MB703R

ROSS Aortic Valve Retractor

Catalog Number	Blade Size (mm)	Length (in.)
MB047R	15 x 15	1
MB048R	13 x 22	0
MB700R	17 x 24	1
MB701R	13 x 27	0
MB702R	30 x 28	1
MB703R	40 x 25	0

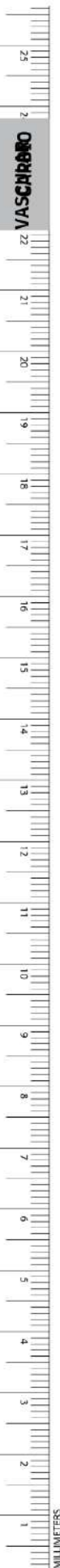
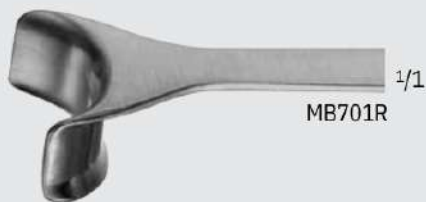



FB923R-FB927R

1/2

COOLEY Atrium Retractor, Left

Catalog Number	Blade Size (mm)	Length (in.)
FB923	25 x 20	9 5/8
R	25 x 25	9 5/8
FB924	25 x 30	9 5/8
R	25 x 35	9 5/8
FB925	25 x 45	9 5/8

R
FB926
R
FB927
R



25 x 20 mm

FB923R

1/1



25 x 25 mm

FB924R

1/1



25 x 30 mm

FB925R

1/1



25 x 35 mm

FB926R

1/1

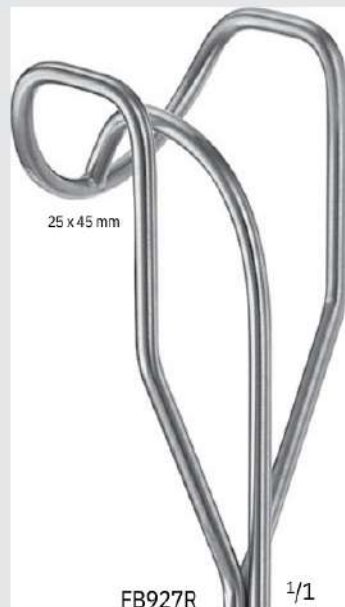

25 x 45 mm

FB927R

1/1



INCHES

Cardiovascular

Retractors



COOLEY Atrium Retractor, Right

Catalog Number	Blade Size (mm)	Length (in.)
FB963	25 x 20	9 1/4
R	40 x 25	9 1/4
FB964	40 x 30	9 1/4
R	40 x 35	9 1/4
FB965	40 x 45	9 1/4
R	50 x 35	9 1/4

FB963R-FB968R

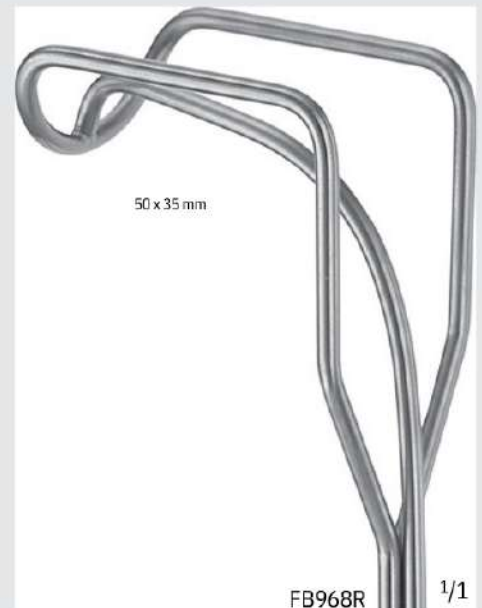
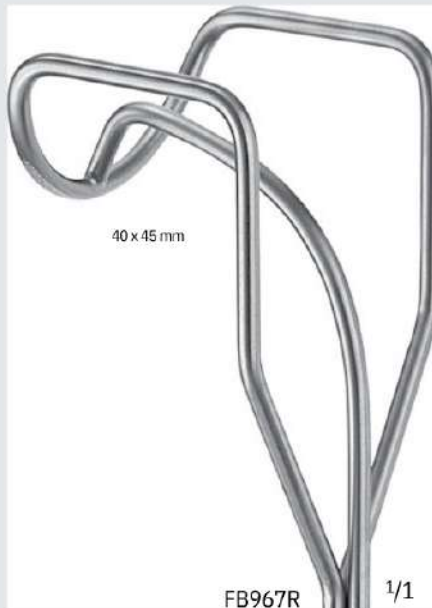
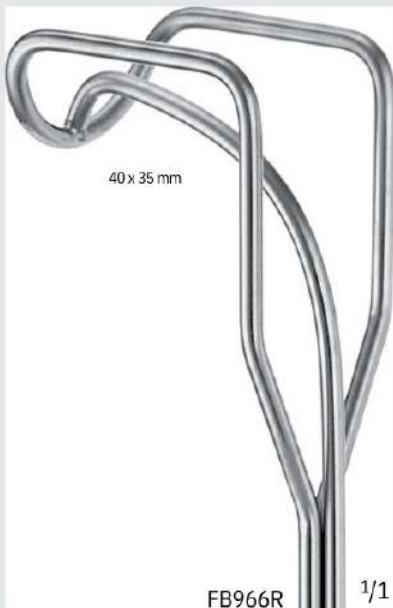

COOLEY Atrial Retractor, Right

Catalog Number	Blade Size (mm)	Length (in.)
MB383R	22 x 19	9 1/4
MB385R	29 x 19	9 1/4
MB386R	38 x 38	9 1/4
MB387R	48 x 44	9 1/4



MB383R-MB387R

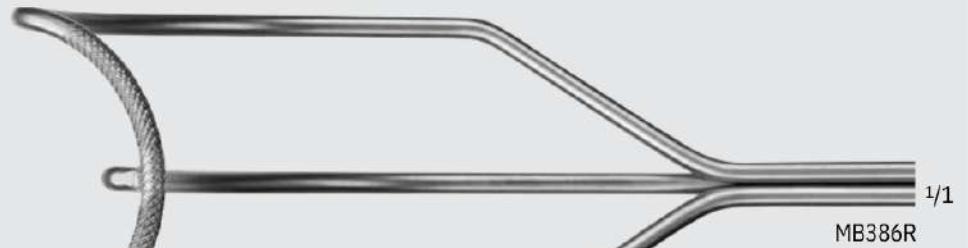
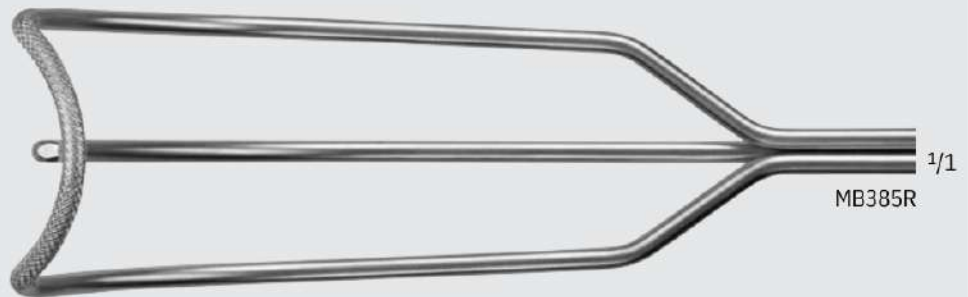
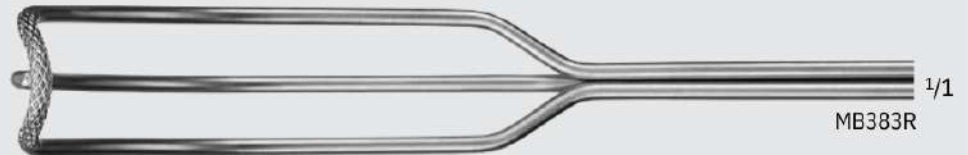

INCHES

Cardiovascular

Retractors



VASCARRO

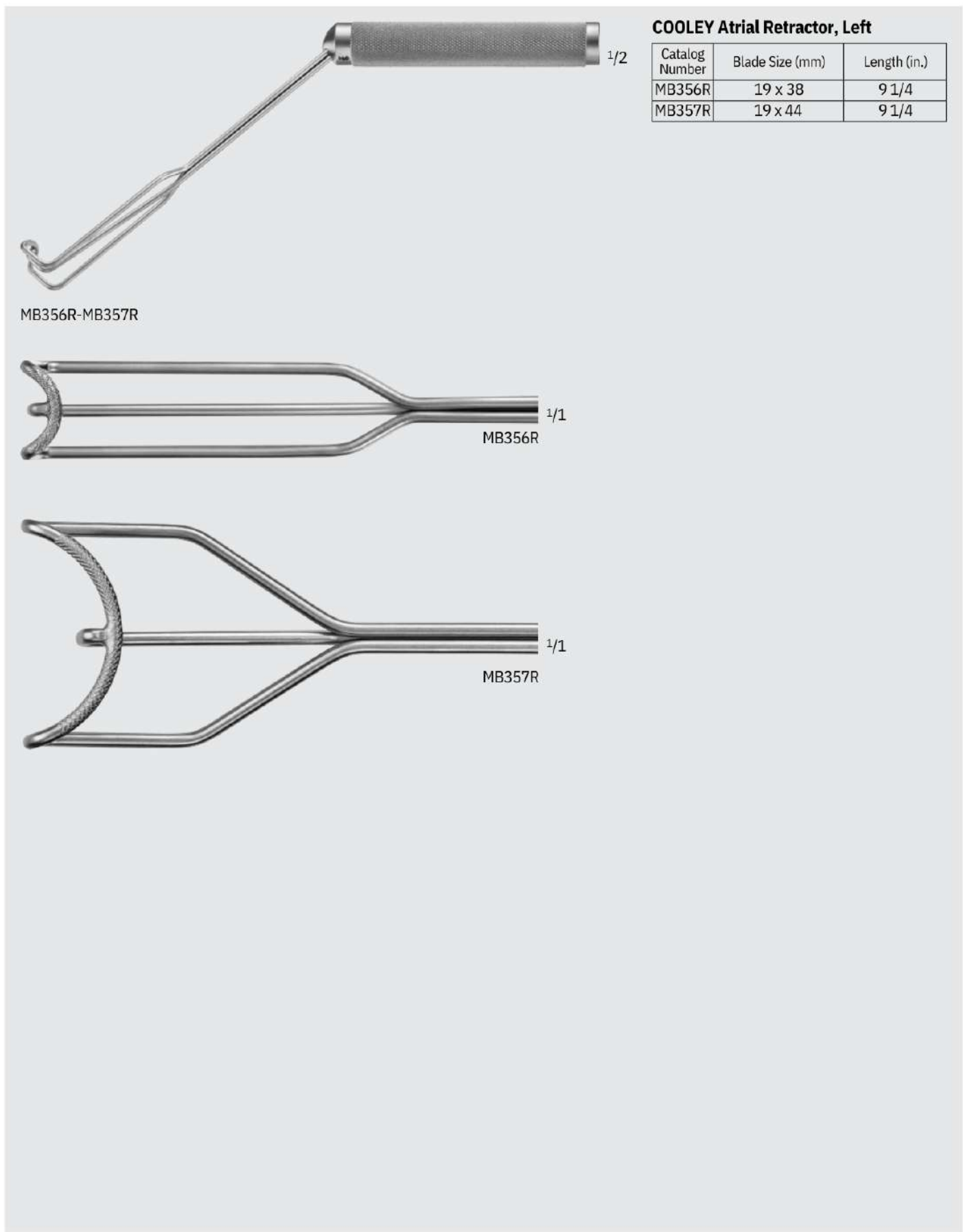

COOLEY Atrial Retractor, Left

Catalog Number	Blade Size (mm)	Length (in.)
MB356R	19 x 38	9 1/4
MB357R	19 x 44	9 1/4



MB356R-MB357R

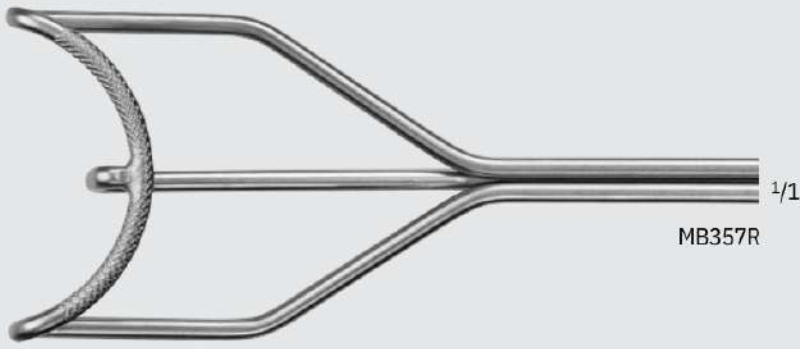

KRASKY Retractor

Catalog Number	Blade End	Tip	Blade Size (mm)	Length (in.)
MG067R	6	PRONGS SHARP	51 x 25	11



MG067R



MG067R



INCHES

Cardiovascular

Retractors



VASCARBO

CORYLLOS Retractor

Catalog Number	Blade Size (mm)	Length (in.)
BT521R	80 x 20	10
BT522R	115 x 38	10
BT523R	115 x 65	10

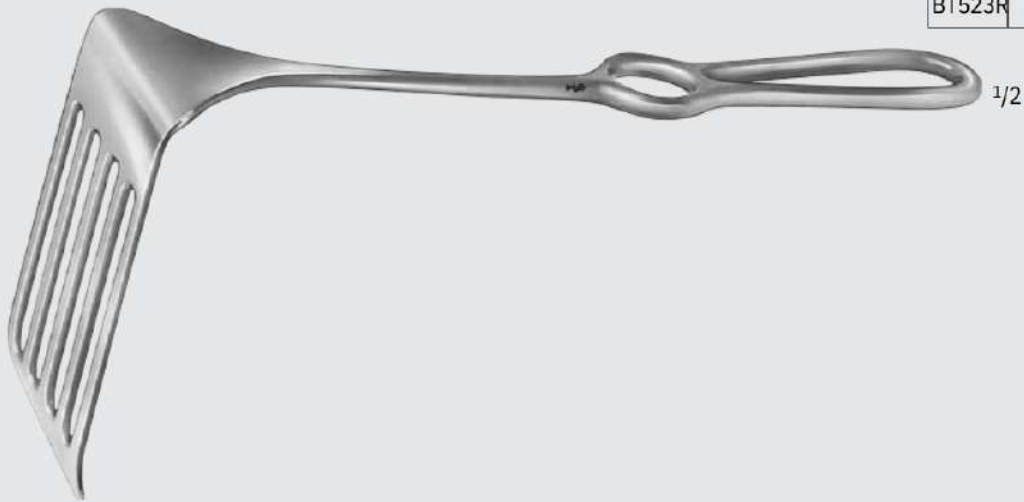

BT521R-BT523R



BT521R



BT522R

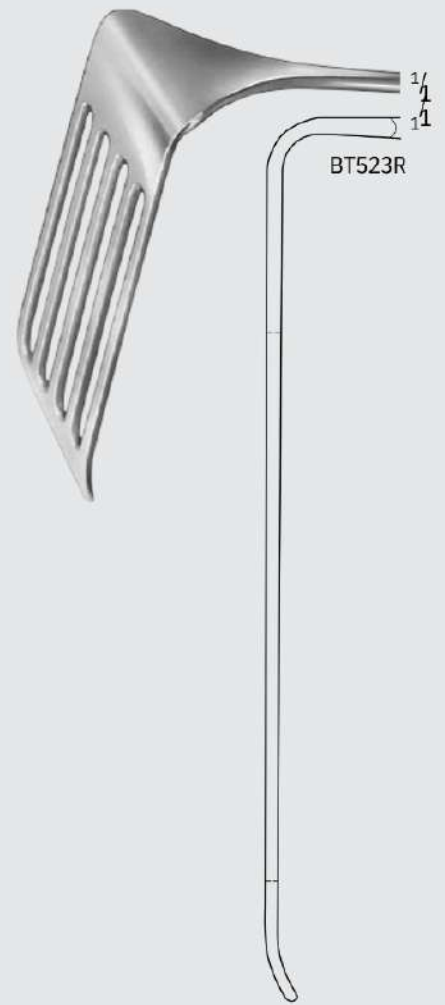

BT523R

DAVIDSON Scapula Retractor

Catalog Number	Blade Size (mm)	Length (in.)
MB758R	80 x 50	7 3/4
BT531R	90 x 80	7 3/4



MB758R



BT531R



Cardiovascular

Retractors

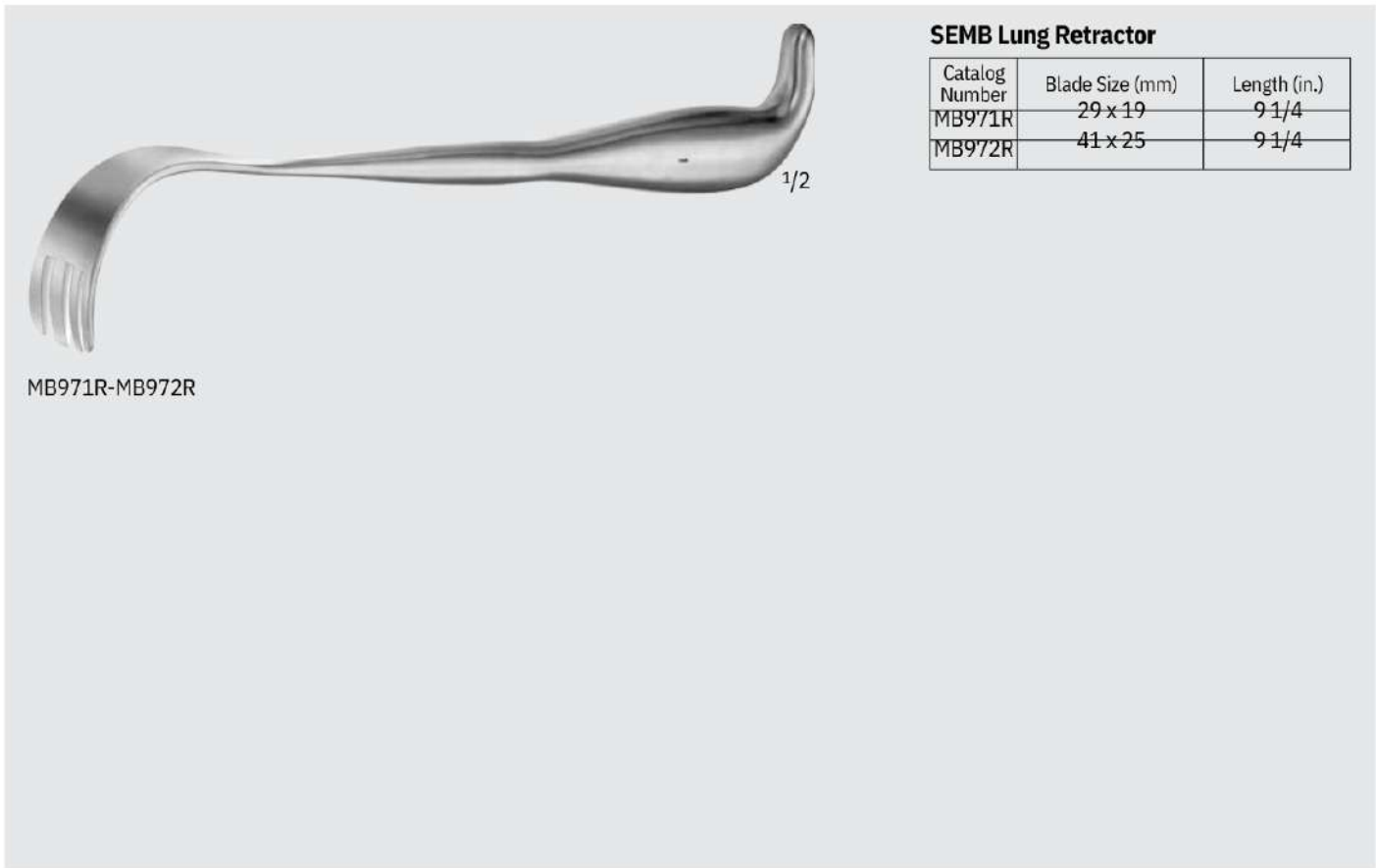

SEMBA Lung Retractor

Catalog Number	Blade Size (mm)	Length (in.)
MB971R	29 x 19	9 1/4
MB972R	41 x 25	9 1/4

MB971R-MB972R

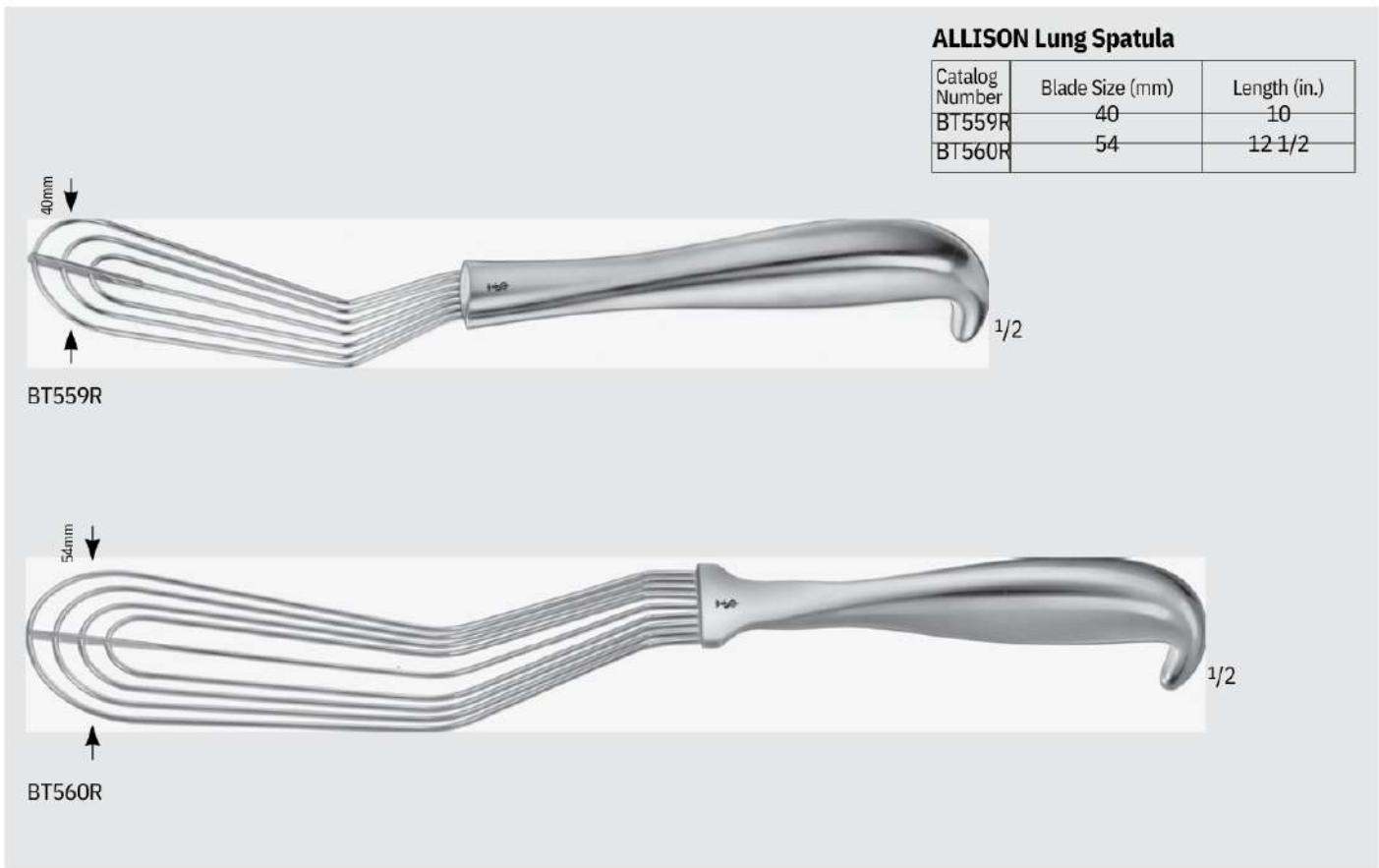

ALLISON Lung Spatula

Catalog Number	Blade Size (mm)	Length (in.)
BT559R	40	10
BT560R	54	12 1/2

BT559R

BT560R

Cardiovascular

Retractors

ALLISON "Sweetheart" Lung Spatula

Catalog Number	Blade Size (mm)	Length (in.)
BT561R	137	11 3/4

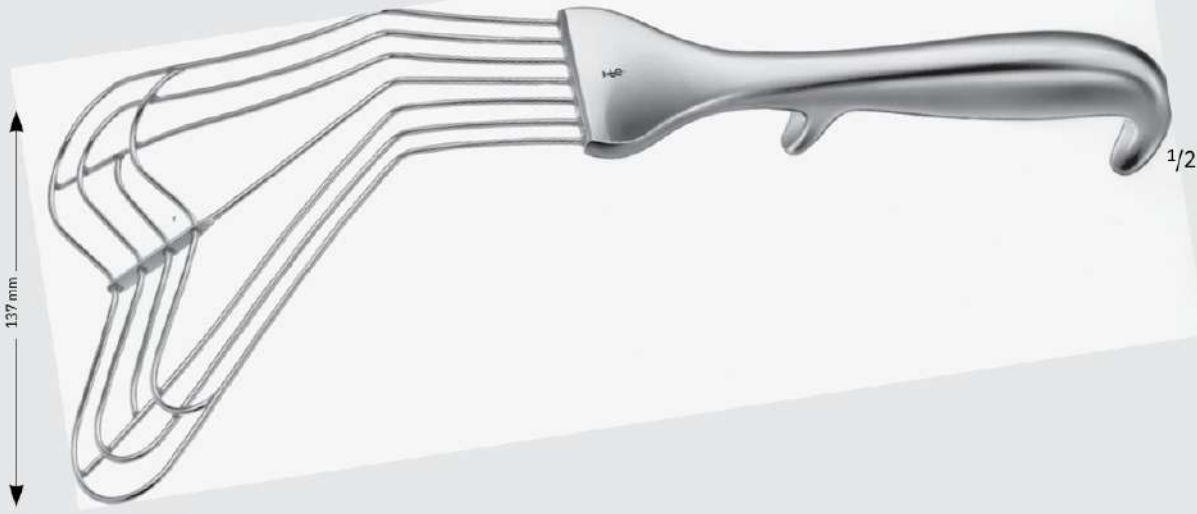

BT561R



INCHES

Cardiovascular

Rib Spreaders



Dimensions for blade size of rib spreaders:
 1st number = Depth
 2nd number = Width
 Example: 38 x 45 mm

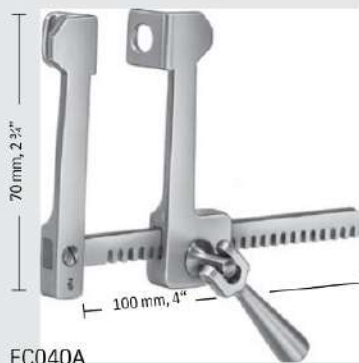

FC040A

FINOCHIETTO Rib Spreader, Aluminum

Catalog Number	Blade Size (mm)
FC040A	12 x 15



FC041A

FINOCHIETTO-HAIGHT Rib Spreader, Aluminum

Catalog Number	Blade Size (mm)
FC041A	28 x 30



FC042A

FINOCHIETTO Rib Spreader, Aluminum

Catalog Number	Blade Size (mm)
FC042A	31 x 45



FC043A

FINOCHIETTO Rib Spreader, Aluminum

Catalog Number	Blade Size (mm)
FC043A	42 x 61

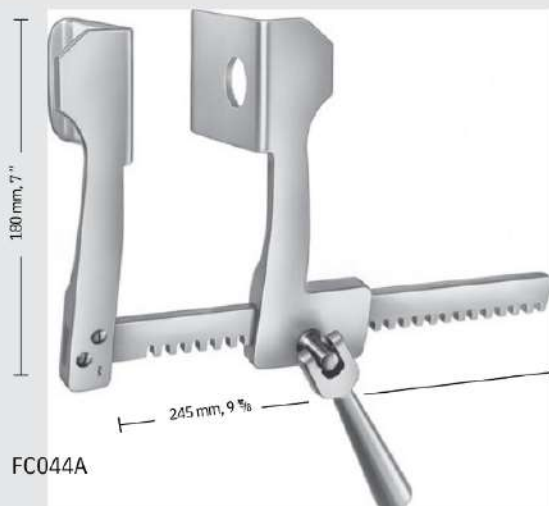

FC044A

FINOCHIETTO Rib Spreader, Aluminum

Catalog Number	Blade Size (mm)
FC044A	74 x 64



INCHES