





Obstetrics/Gynecology

Scissors	1202 - 1211
Needle Holders	1212
Forceps	1213 - 1250
Clamps	1251 - 1260
Retractors	1261 - 1262
Vaginal Retractors and Specula	1263 - 1281
Endospecula	1282
Dilators and Probes	1283 - 1287
Curettes	1288 - 1294
Accessories	1295

Obstetrics/Gynecology

Scissors

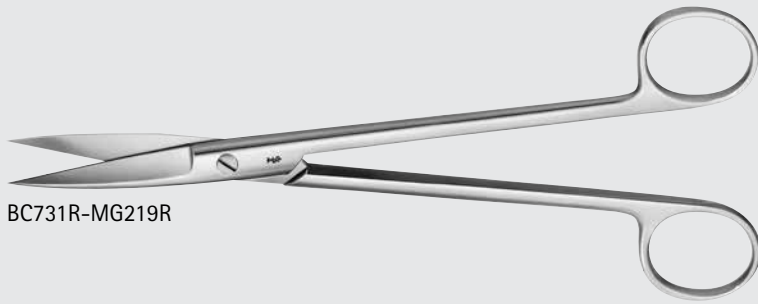

BC731R-MG219R

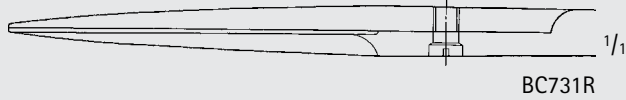

BC731R

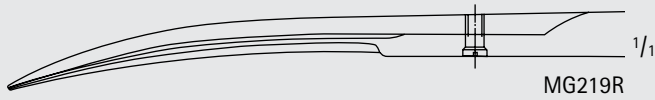

MG219R

SIMS Scissors

Catalog Number	Tip	Blade	Length (in.)
BC731R	S/S	STR	7 7/8
MG219R	S/S	CVD	8

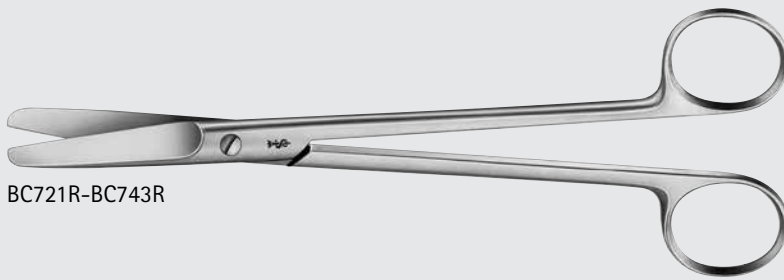

BC721R-BC743R

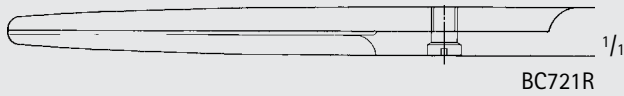

BC721R

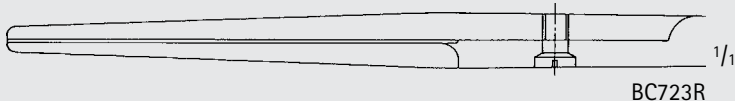

BC723R

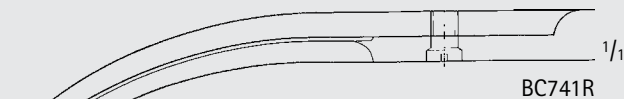

BC741R



BC708R

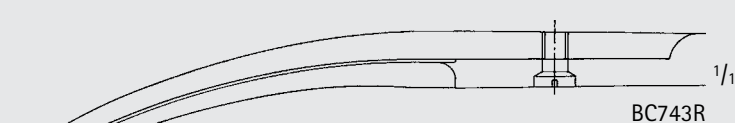

BC743R

SIMS Scissors

Catalog Number	Tip	Blade	Length (in.)
BC721R	B/B	STR	7 7/8
BC723R	B/B	STR	9
BC741R	B/B	CVD	7 7/8
BC708R	B/B	CVD	8 1/4
BC743R	B/B	CVD	9

OB/GYN

MILLIMETERS

SIMS Scissors (continued)

Catalog Number	Tip	Blade	Length (in.)
MG218R	S/B	STR	8
BC746R	S/B	CVD	7 7/8
BC748R	S/B	CVD	9

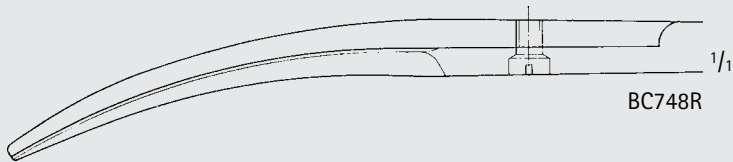
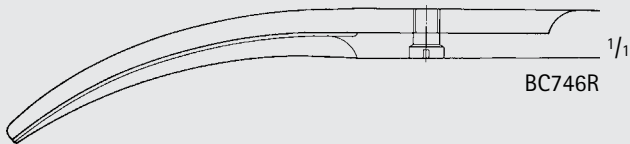
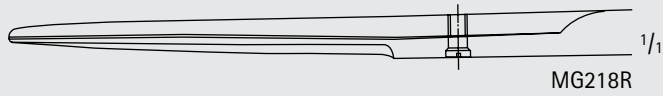
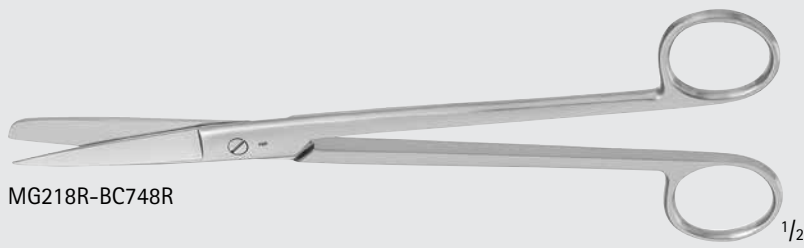

Obstetrics/Gynecology

Scissors



BC702R-BC704R

WERTHEIM Scissors

Catalog Number	Tip	Blade	Length (in.)
BC702R	B/B	CVD	5 3/4
BC703R	B/B	CVD	7 7/8
BC704R	B/B	CVD	9

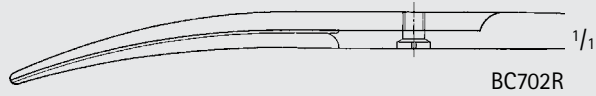

BC702R

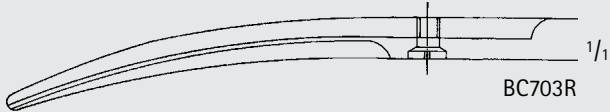

BC703R

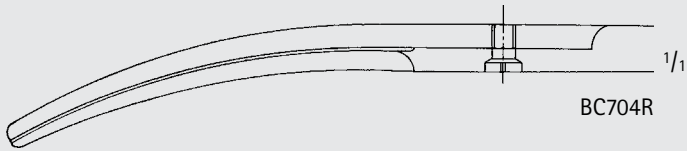

BC704R



OB/GYN

MILLIMETERS

JORGENSEN Scissors

Catalog Number	Tip	Blade	Length (in.)
MD491	B/B	CVD	8 3/4

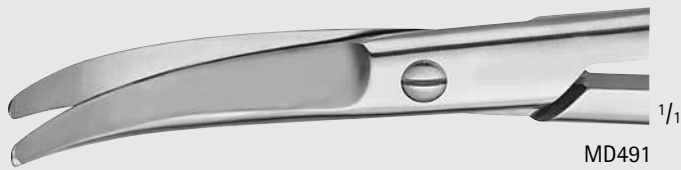
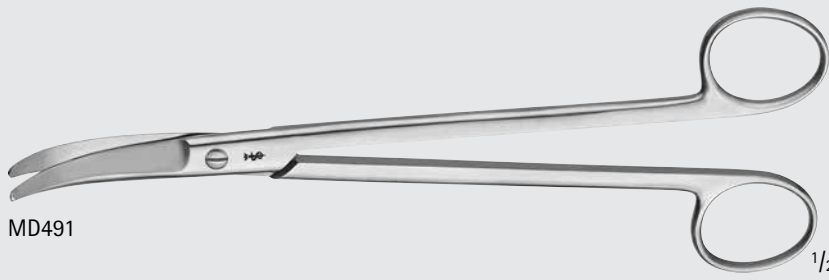

SIEBOLD Uterine Scissors

Catalog Number	Tip	Blade	Length (in.)
BC760R	B/B	CVD	9 5/8

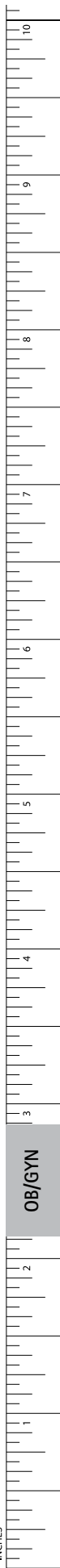
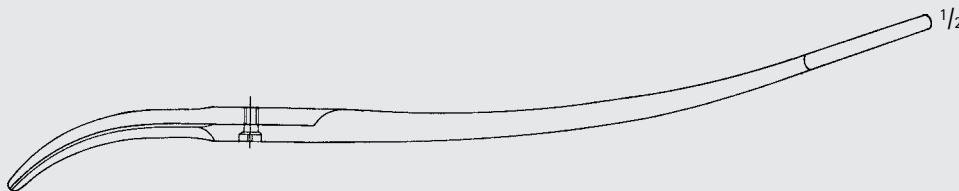
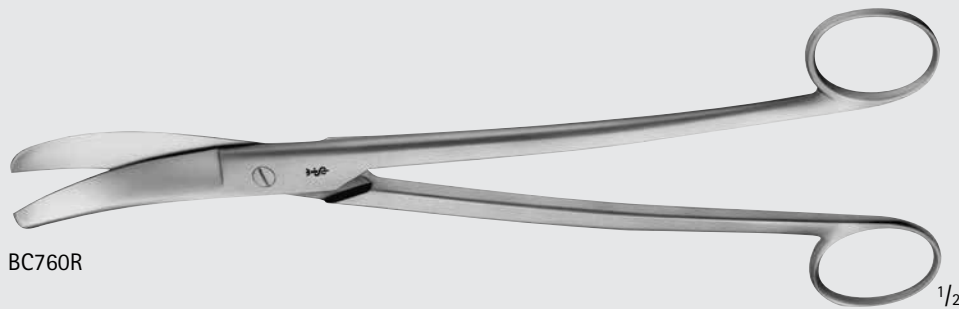

Obstetrics/Gynecology

Scissors

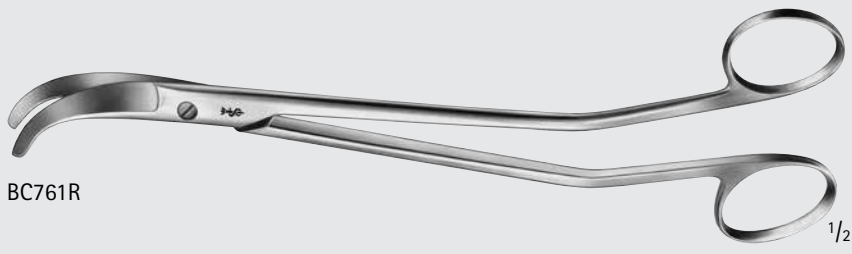
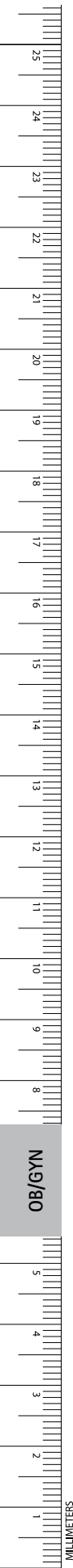

BC761R

BOZEMANN Uterine Scissors

Catalog Number	Tip	Blade	Length (in.)
BC761R	B/B	CVD	8 3/4

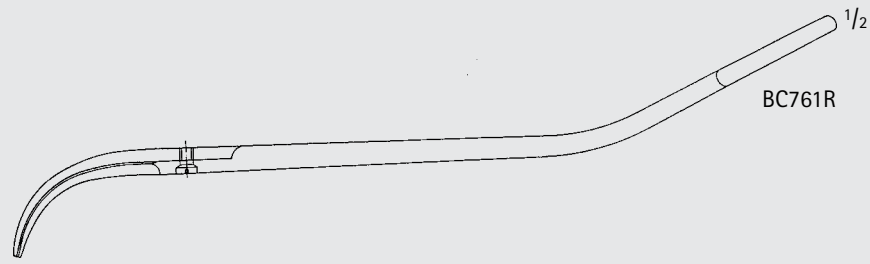

BC761R

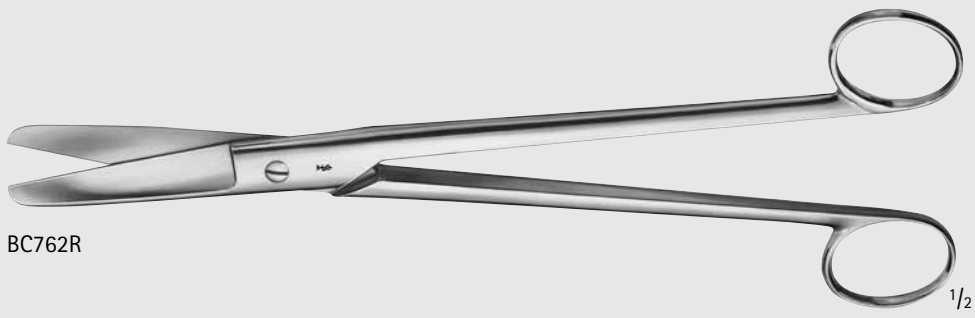

BC762R

SIMS-SIEBOLD Uterine Scissors

Catalog Number	Tip	Blade	Length (in.)
BC762R	B/B	STR	9 3/4

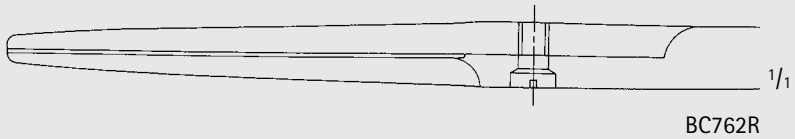

BC762R

DUROTIP TC MAYO Dissecting Scissors

Catalog Number	Tip	Blade	Length (in.)
BC558R	B/B	STR	9
MG215R	B/B	STR	14
BC559R	B/B	CVD	9
MB726R	B/B	CVD	14

BC558R-BC559R, MB726R, MG215R

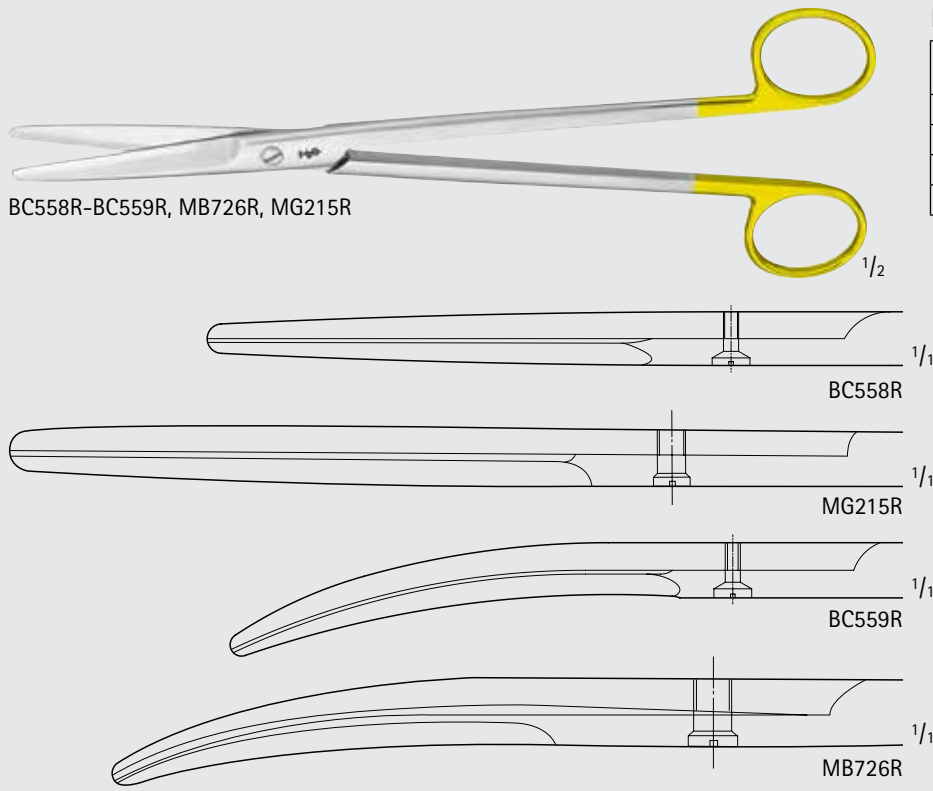

DUROTIP TC SIMS Uterine Scissors

Catalog Number	Tip	Blade	Length (in.)
BC290R	B/B	CVD	7 7/8
BC291R	B/B	CVD	9

BC290R-BC291R

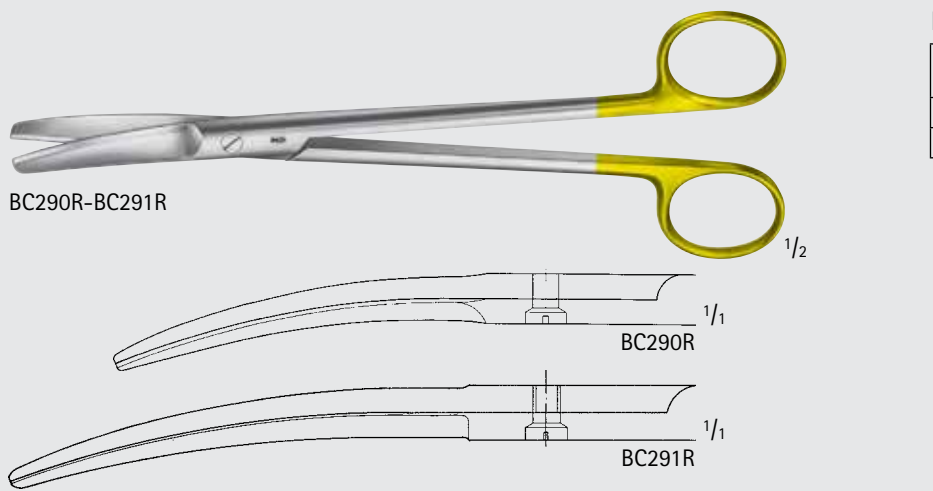

DUROTIP TC WERTHEIM Scissors

Catalog Number	Length (in.)
BC293R	9

BC293R

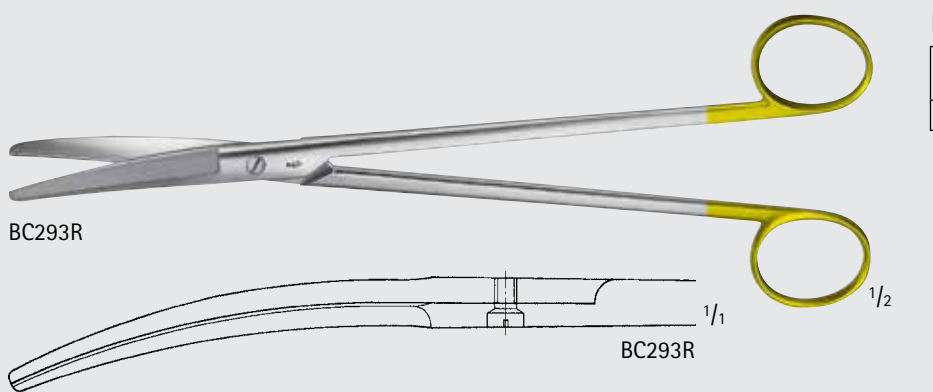

Obstetrics/Gynecology

DUROTIP™ TC Scissors

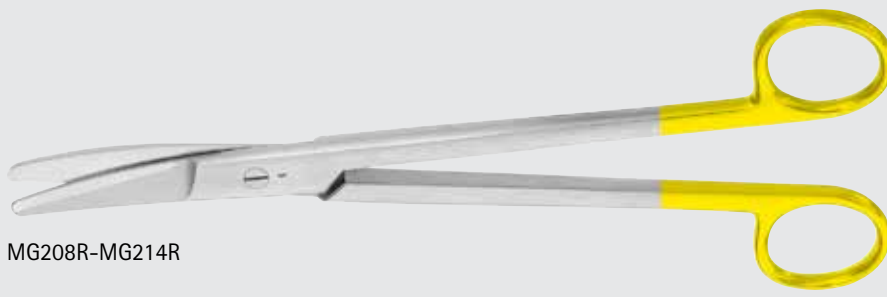

MG208R-MG214R

DUROTIP TC Uterine Scissors

Catalog Number	Tip	Length (in.)
MG208R	SLIGHT CVD	9
MG209R	STRONG CVD	9
MG210R	ANG	9
MG211R	ANG	10 1/2
MG212R	SLIGHT CVD	11 3/4
MG213R	STRONG CVD	11 3/4
MG214R	ANG	11 3/4

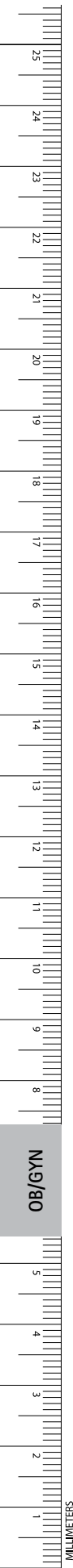
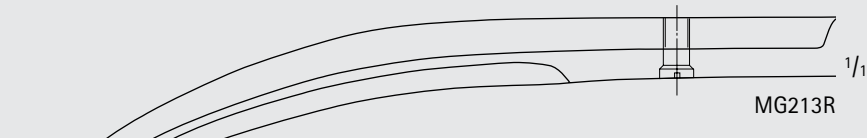
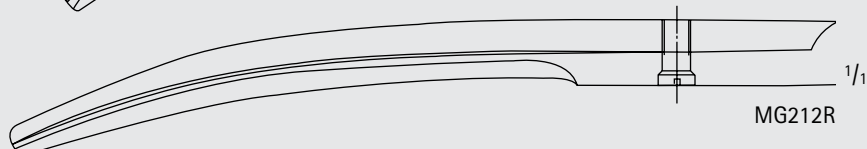
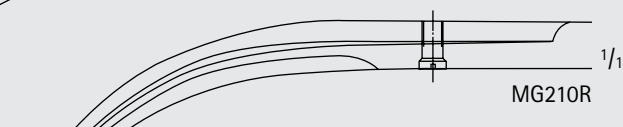
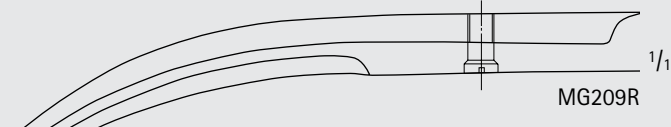
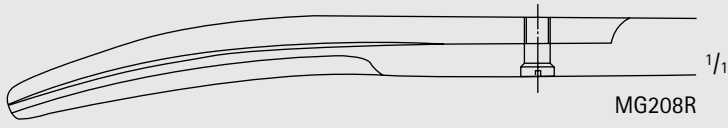



Wavecut

Wavecut scissors have one serrated cutting edge to help prevent tissue from slipping. The W after the item number indicates the scissors are the wavecut style, e.g. BC211W.



BC290W-BC291W

DUROTIP TC SIMS Uterine Wavecut Scissors

Catalog Number	Tip	Blade	Length (in.)
BC290W	B/B	CVD	7 7/8
BC291W	B/B	CVD	9

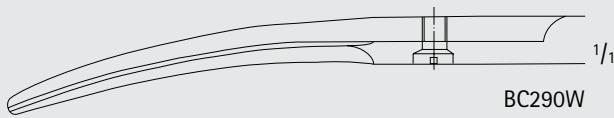

BC290W



BC291W



BC287W

DUROTIP TC METZENBAUM Wavecut Dissecting Scissors, Heavy

Catalog Number	Tip	Blade	Length (in.)
BC287W	B/B	CVD	9

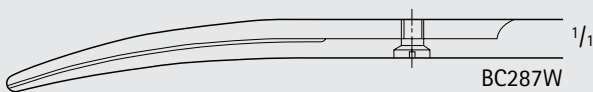

BC287W

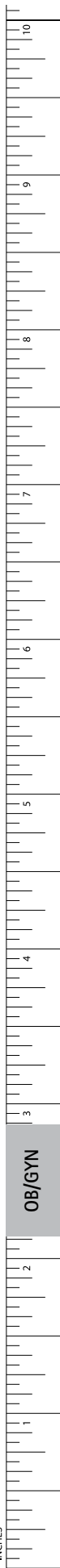

INCHES

OB/GYN

Obstetrics/Gynecology

Scissors



BC796R-BC797R

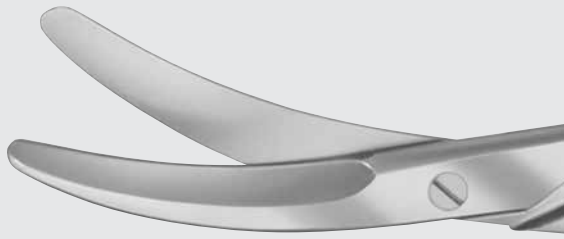

BC796R

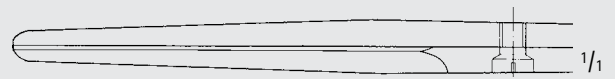

BC797R

Umbilical Cord Scissors

Catalog Number	Tip	Blade	Length (in.)
BC796R	B/B	LAT-CVD	5 1/4
BC797R	B/B	LAT-CVD	6 1/4



ET152R

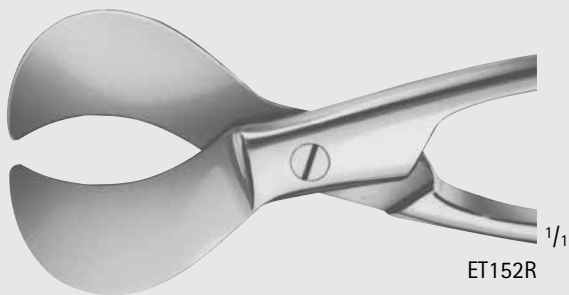

ET152R

Umbilical Cord Scissors

Catalog Number	Length (in.)
ET152R	4 1/8

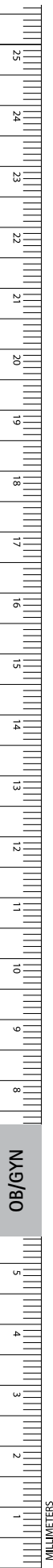

OB/GYN

SCHUHMACHER Umbilical Cord Scissors

Catalog Number	Length (in.)
ET150R	6 1/8

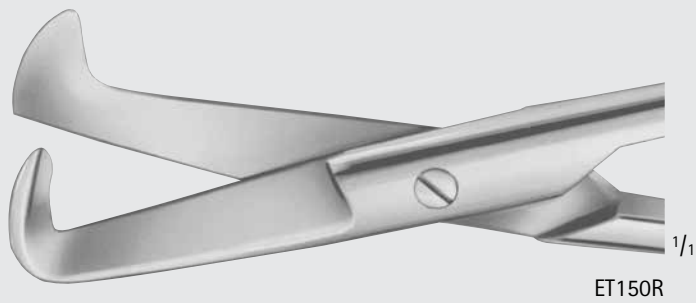
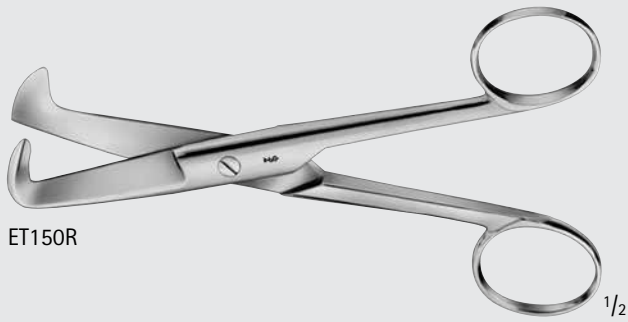

BRAUN-STADLER Episiotomy Scissors

Catalog Number	Blade	Length (in.)
ET140R	SERR	5 3/4
ET141R	SERR	7 7/8

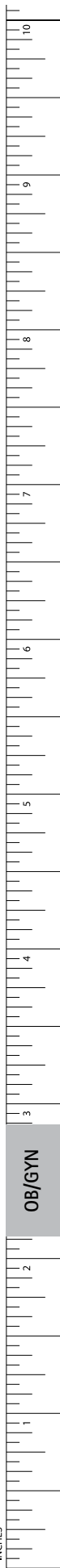
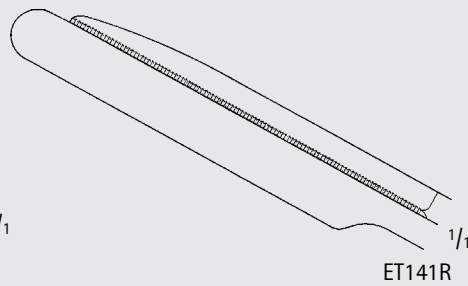
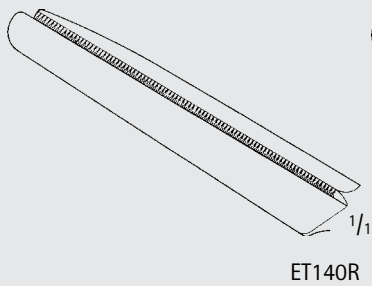

Obstetrics/Gynecology

Needle Holders

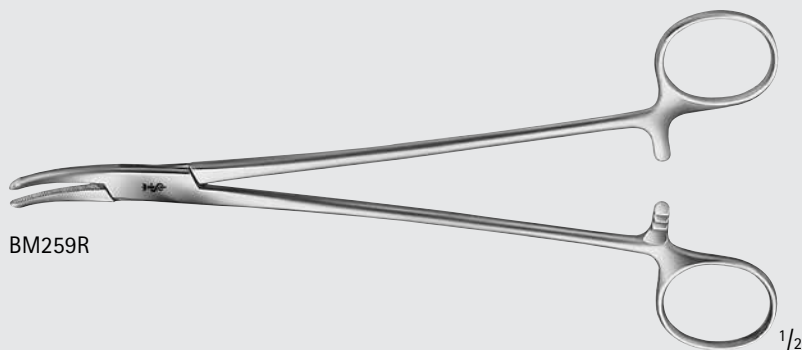

BM259R

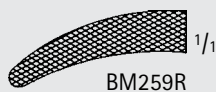

HEANEY Needle Holder

Catalog Number	Tip	Jaw	Length (in.)
BM259R	CVD	SERR	7 7/8

Aesculap features Needle Holders with Tungsten Carbide (TC) inserts. A smooth jaw and three different serration patterns are available, depending on the size of the suture needle.

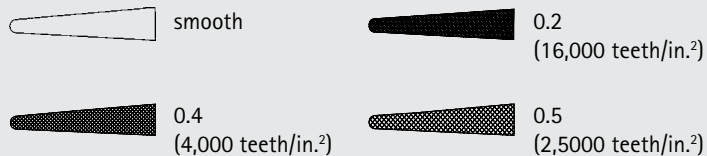
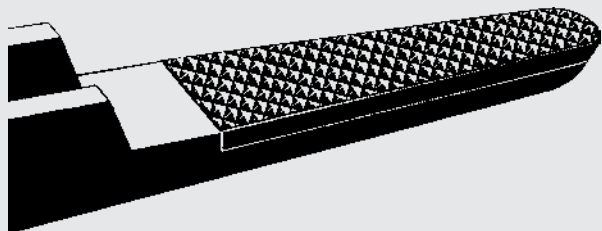

We recommend carbide inserts as follows:

Jaw Surface	Suture Material
Smooth	9/0 - 11/0
0.2 mm pitch of serration	6/0 - 10/0
0.4 mm pitch of serration	4/0 - 6/0
0.5 mm pitch of serration	up to 3/0

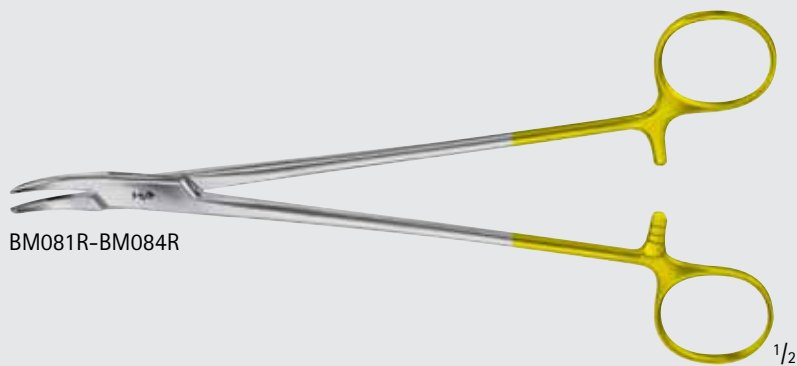

BM081R-BM084R

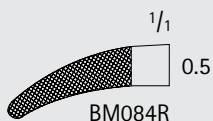
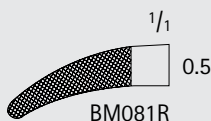

DUROGRIP™ TC HEANEY Needle Holder

Catalog Number	Tip	Jaw	Length (in.)
BM081R	CVD	SERR	7 7/8
BM084R	CVD	SERR	10 1/4

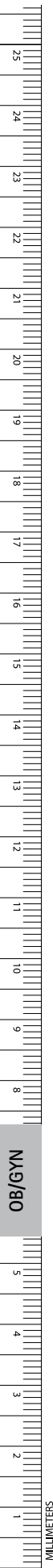

Obstetrics/Gynecology

Tenaculum and Sponge Forceps

MAIER Forceps

Catalog Number	Jaw	Length (in.)
BF056R	STR	10 1/2
BF057R	CVD	10 1/2

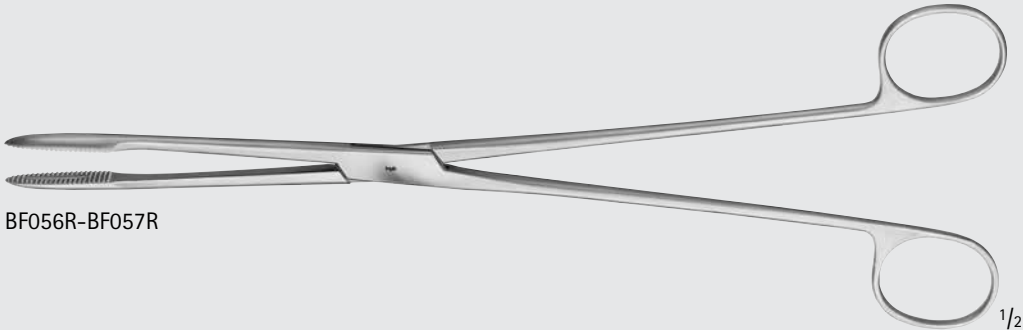

BF056R-BF057R

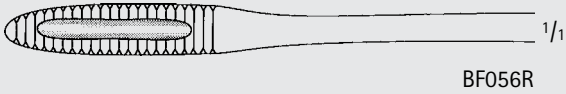

BF056R

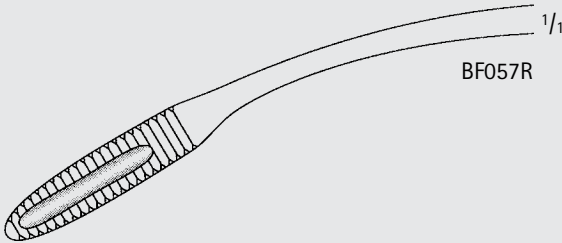

BF057R

MAIER Forceps, W/ Ratchet

Catalog Number	Jaw	Length (in.)
BF058R	STR	10 1/4
BF059R	CVD	10 1/4

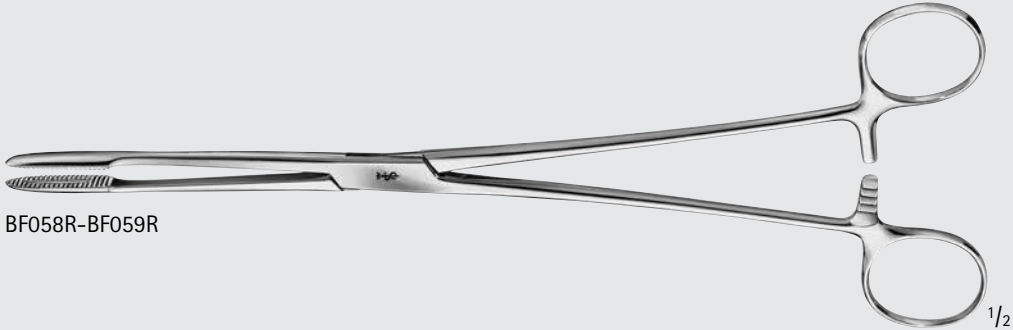

BF058R-BF059R



BF058R

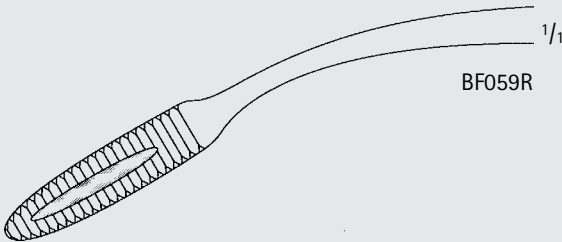

BF059R



Obstetrics/Gynecology

Tenaculum and Sponge Forceps

SIMS-MAIER Sponge Forceps, W/ Ratchet

Catalog Number	Jaw	Length (in.)
BF076R	STR	11
BF077R	CVD	11

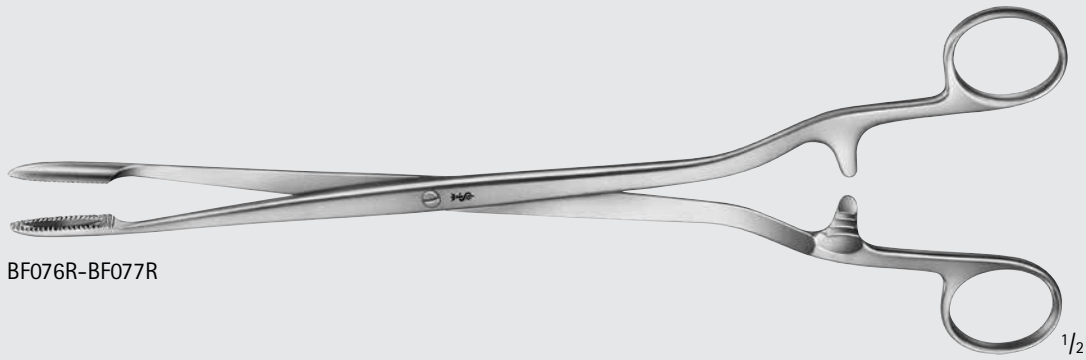

BF076R-BF077R



BF076R



BF077R

PELKMANN Forceps

Catalog Number	Tip	Jaw	Length (in.)
EO060R	SERR	STR	10 1/4
EO061R	SERR	CVD	10 1/4

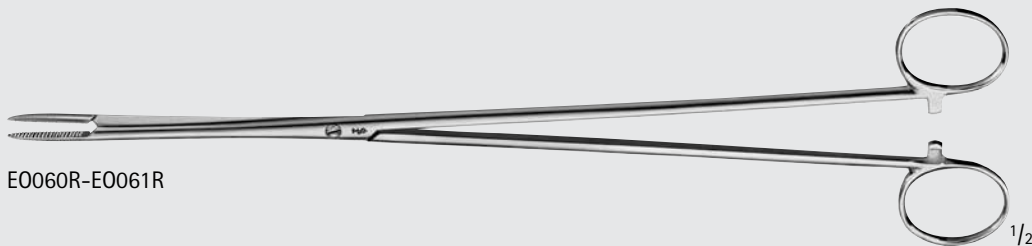

EO060R-EO061R

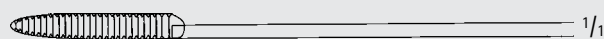

EO060R



EO061R

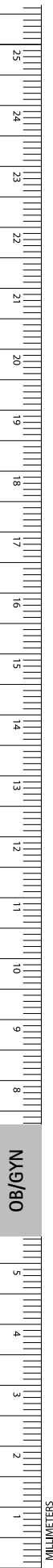

OB/GYN

Obstetrics/Gynecology

Tenaculum and Sponge Forceps

BOZEMANN Forceps

Catalog Number	Shaft	Jaw	Length (in.)
E0080R	STR	SERR	10 1/4
E0075R	S-CVD	SMOOTH	9 3/4
E0082R	S-CVD	SERR	9 3/4
E0077R	S-CVD	W/ GROOVE	10

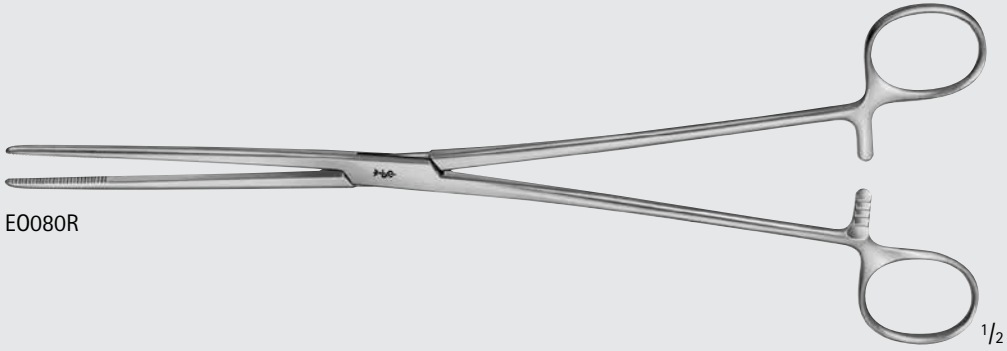

E0080R

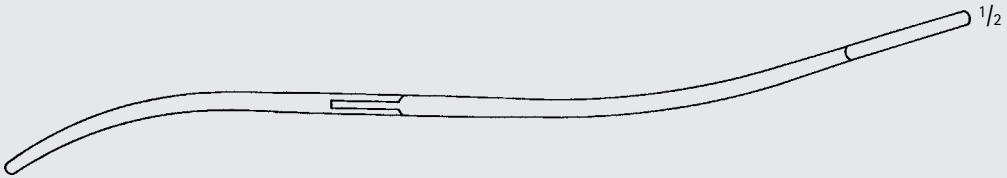

E0080R

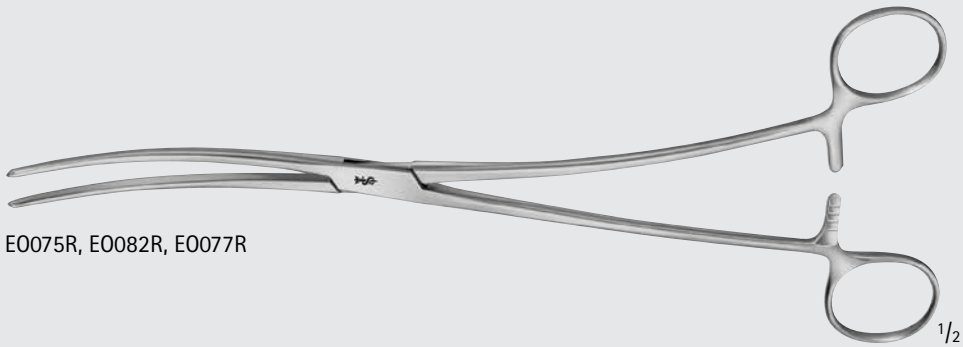

E0075R, E0082R, E0077R

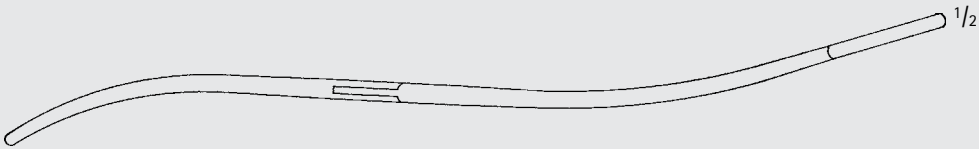

E0075R, E0082R, E0077R

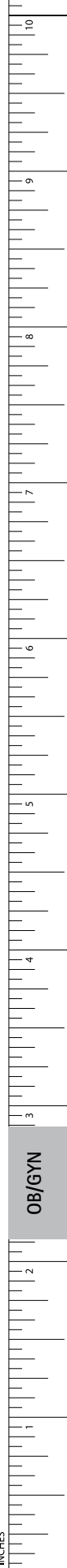

Obstetrics/Gynecology

Tenaculum and Sponge Forceps

BOZEMANN-DOUGLAS Forceps

Catalog Number	Tip	Length (in.)
EO085R	SERR	10 1/4

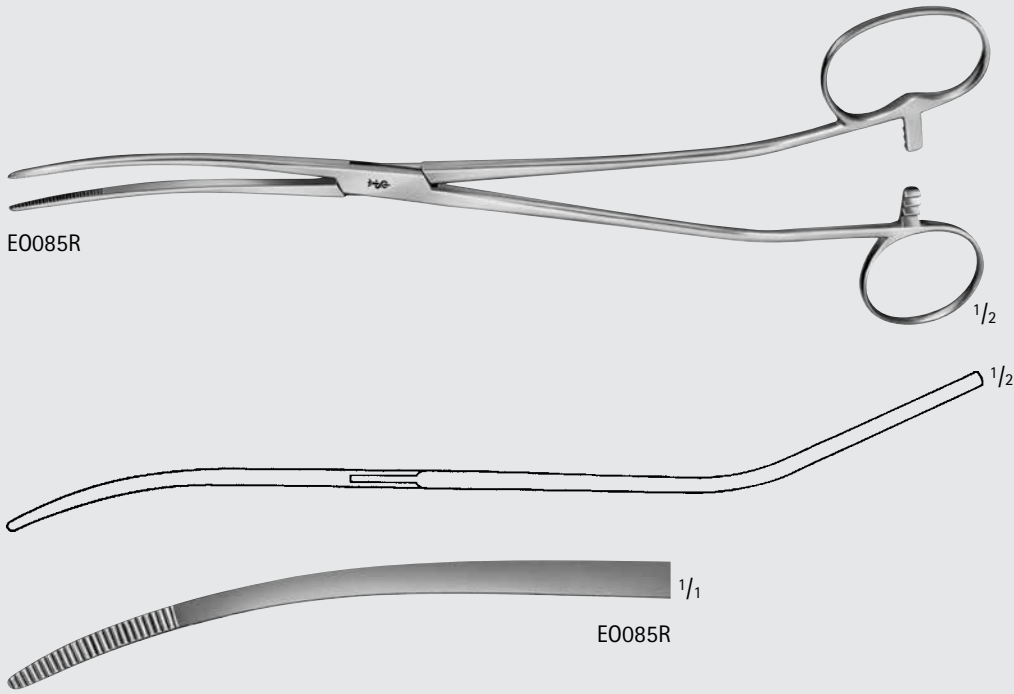

ADAIR Uterine Forceps

Catalog Number	Teeth	Length (in.)
EO106R	1 x 1	7 1/2

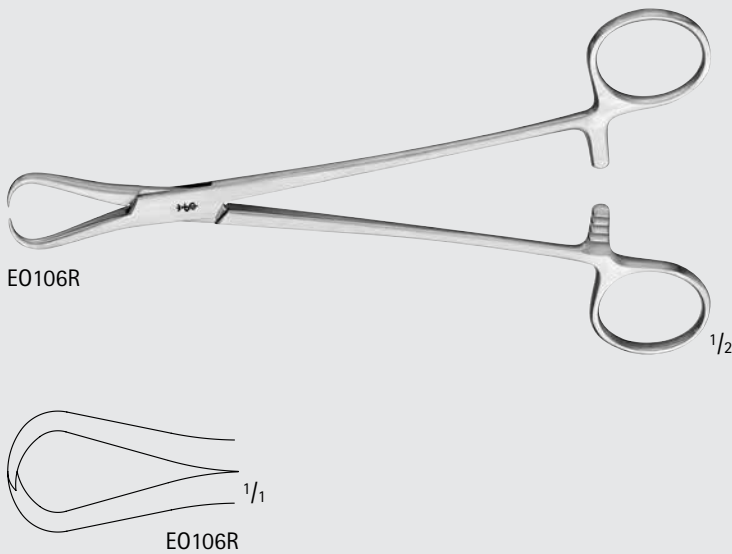

Obstetrics/Gynecology

Tenaculum and Sponge Forceps

POZZI Tenaculum Forceps, Standard

Catalog Number	Teeth	Length (in.)
E0105R	1 x 1	6 7/8



E0105R

1/2

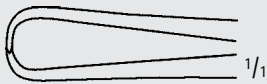

E0105R

1/1

BARRETT Uterine Tenaculum Forceps

Catalog Number	Teeth	Length (in.)
MG200R	1 x 1	7

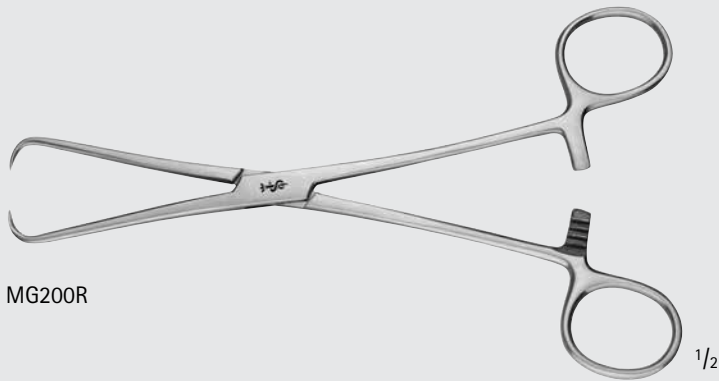

MG200R

1/2



MG200R

1/1

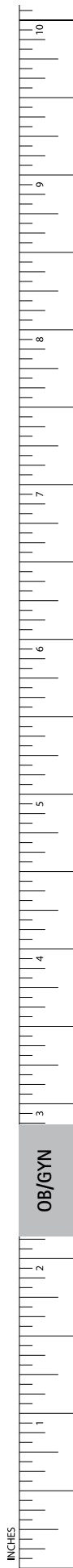

Obstetrics/Gynecology

Tenaculum and Sponge Forceps

BRAUN Tenaculum Forceps

Catalog Number	Teeth	Length (in.)
EO108R	1 x 1	9 3/4

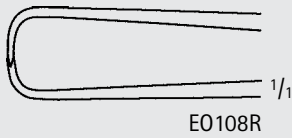
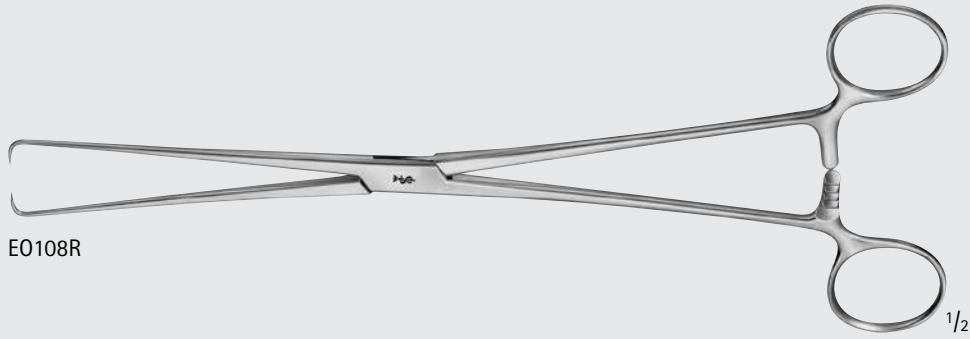

SCHROEDER Tenaculum Forceps

Catalog Number	Shaft	Teeth	Length (in.)
EO110R	STR	1 x 1	9 3/4

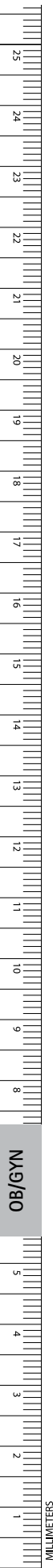
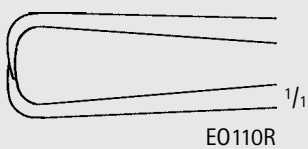
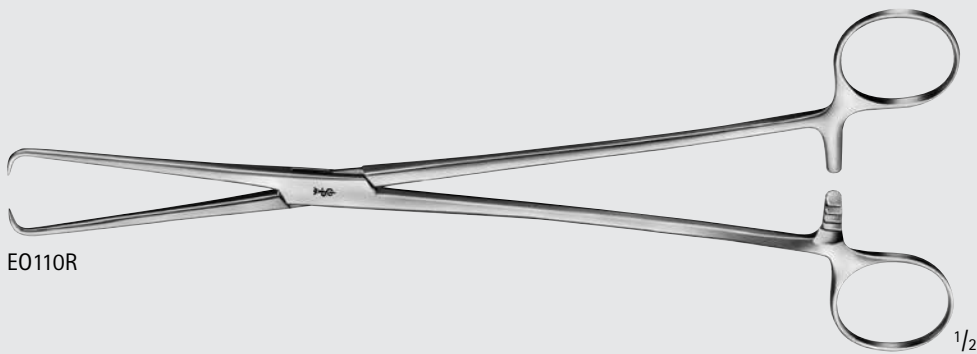

Obstetrics/Gynecology

Tenaculum and Sponge Forceps

SCHROEDER Tenaculum Forceps

Catalog Number	Shaft	Teeth	Length (in.)
E0150R	STR	2 x 2	9 3/4
E0151R	CVD	2 x 2	9 3/4
E0163R	STR	3 x 3	10 5/8

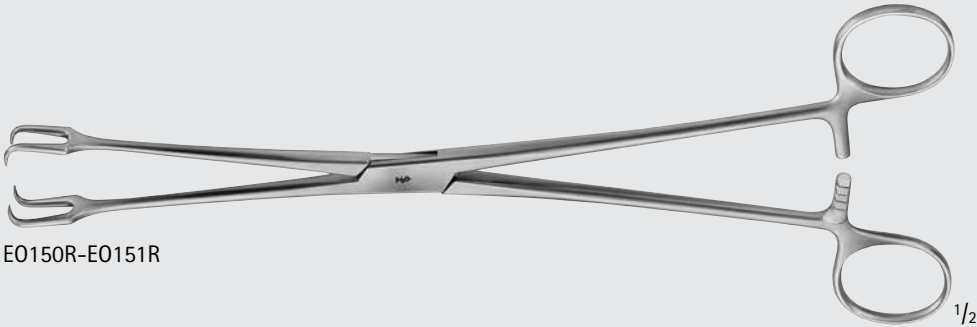

E0150R-E0151R

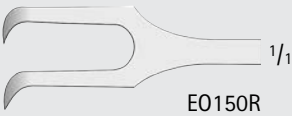

E0150R



E0151R

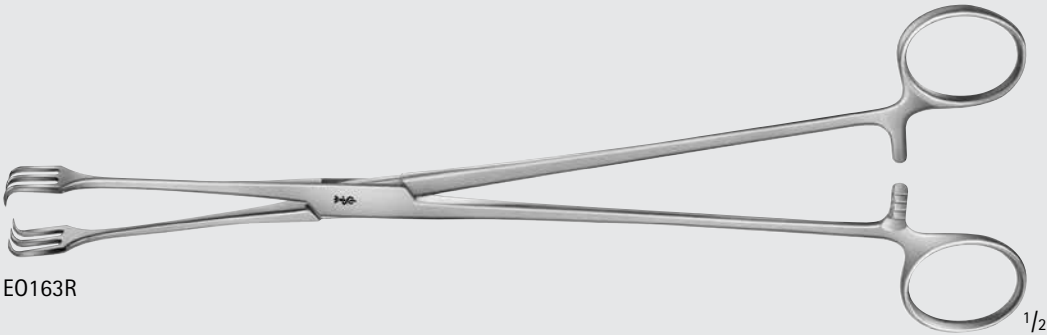

E0163R

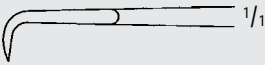

E0163R

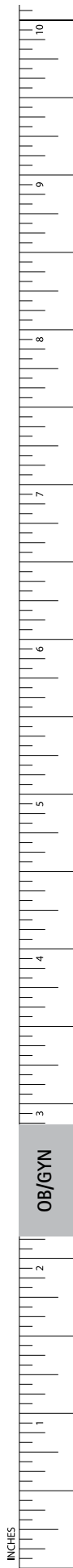

Obstetrics/Gynecology

Tenaculum and Sponge Forceps

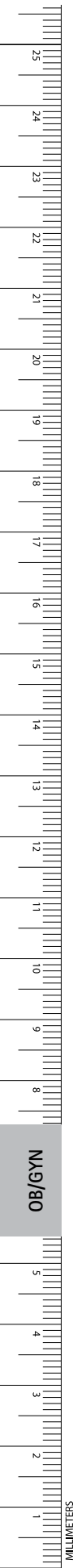

POZZI Tenaculum Forceps, Heavy

Catalog Number	Teeth	Length (in.)
EO125R	1 x 1	10



EO125R

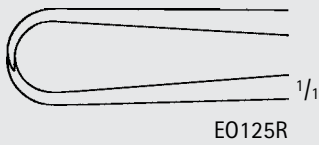

EO125R

DUPLAY Tenaculum Forceps, Delicate

Catalog Number	Teeth	Length (in.)
EO130R	1 x 1	9 3/4

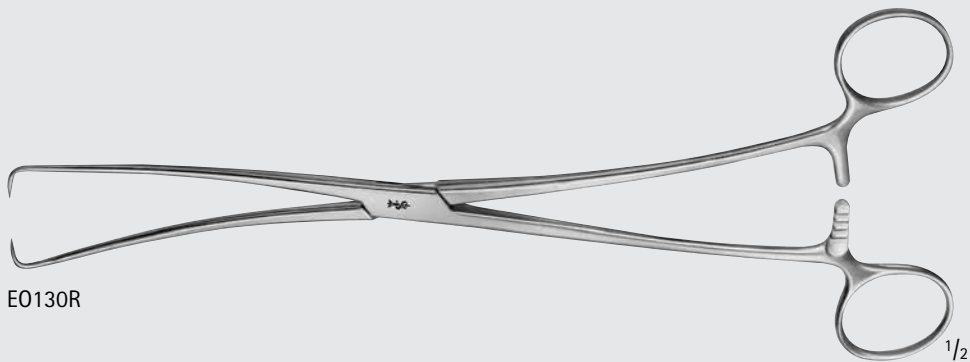

EO130R

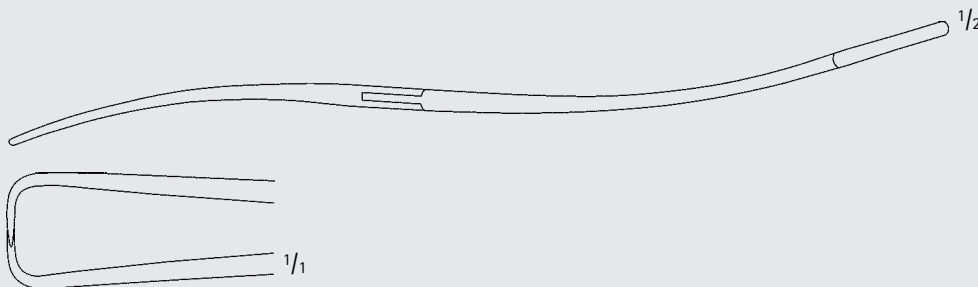

EO130R

Obstetrics/Gynecology

Tenaculum and Sponge Forceps

ABEL Tenaculum Forceps

Catalog Number	Teeth	Length (in.)
EO140R	1 x 1	11

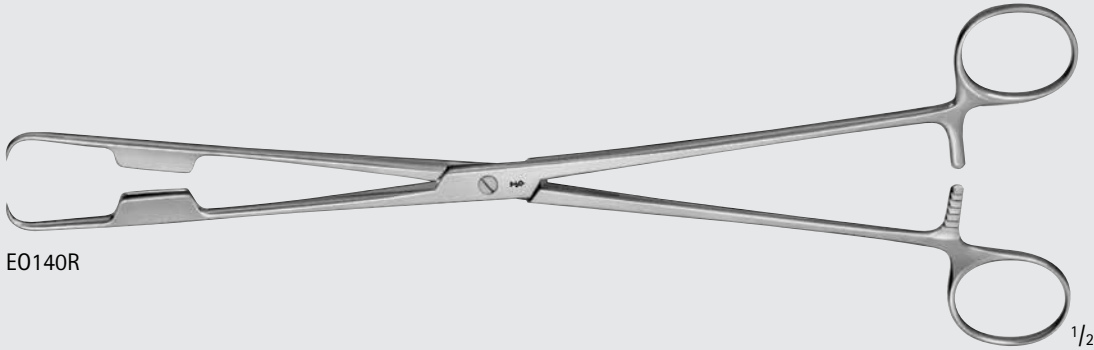

EO140R

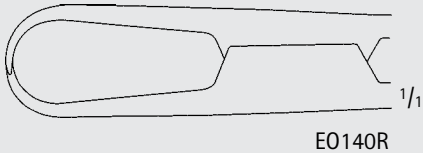

EO140R

HENROTIN Uterine Vulsellum Forceps

Catalog Number	Teeth	Length (in.)
MG202R	2 x 3	8 1/4

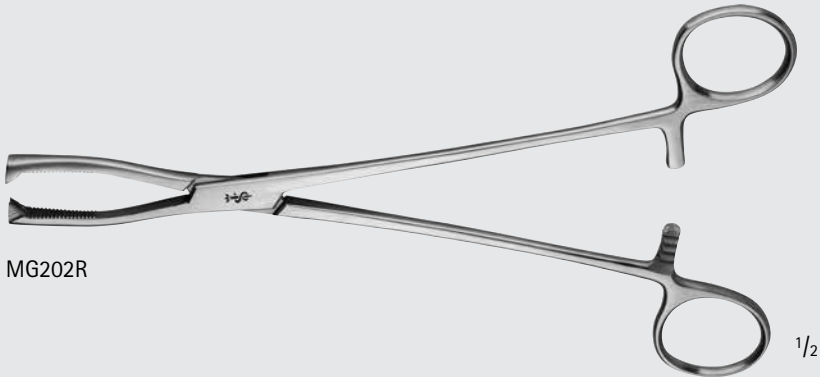

MG202R

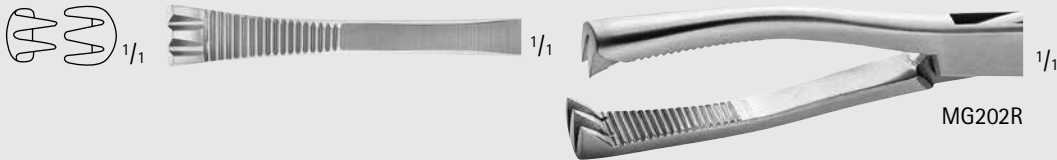

MG202R

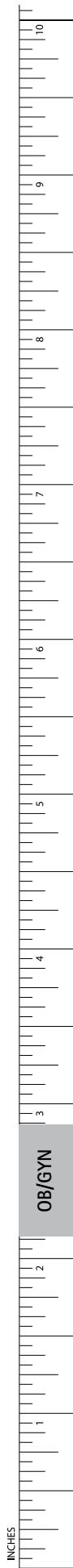

Obstetrics/Gynecology

Tenaculum and Sponge Forceps

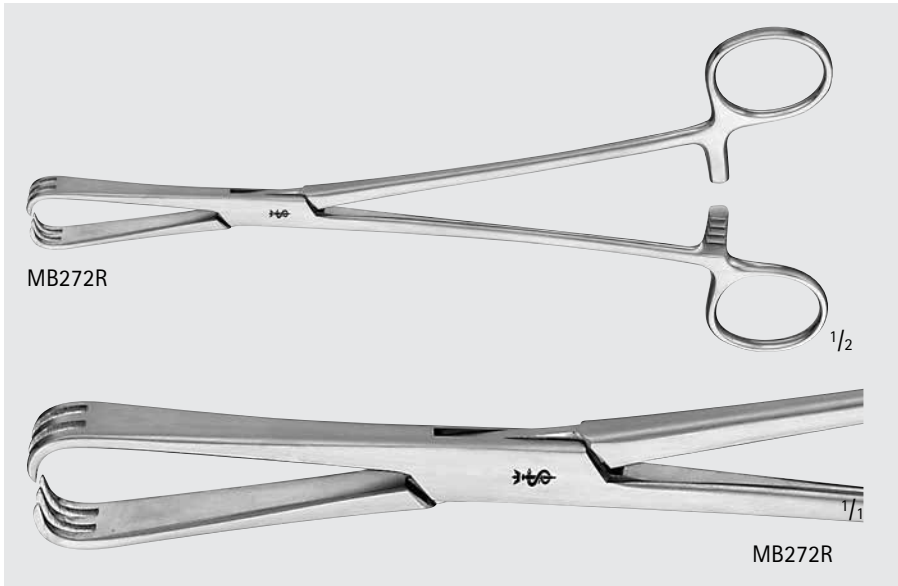
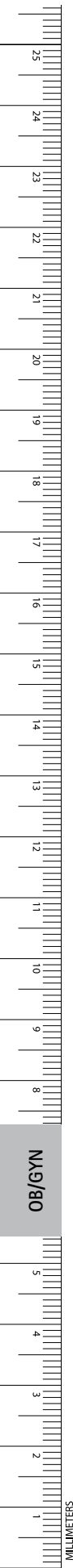

GORDON Uterine Vulsellum Forceps

Catalog Number	Teeth	Length (in.)
MB272R	3 x 3	8 3/4

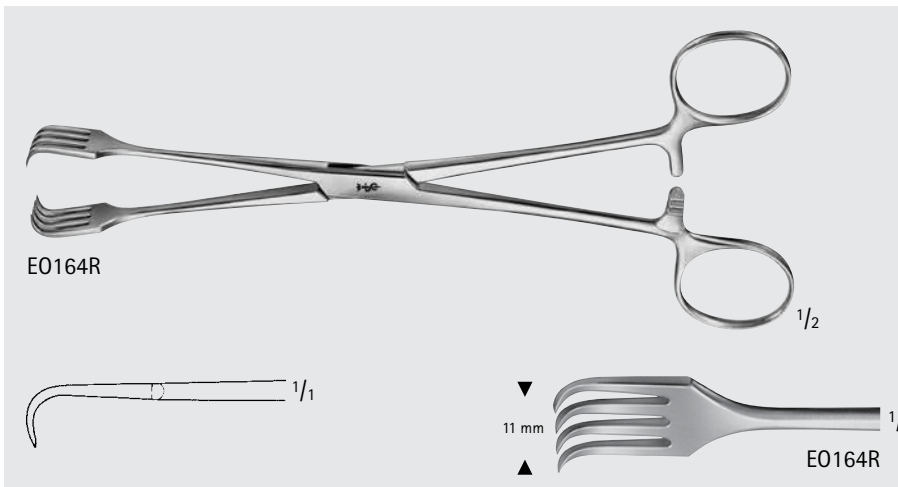

CZERNY Uterine Tenaculum Forceps

Catalog Number	Teeth	Length (in.)
EO164R	4 x 4	7 7/8

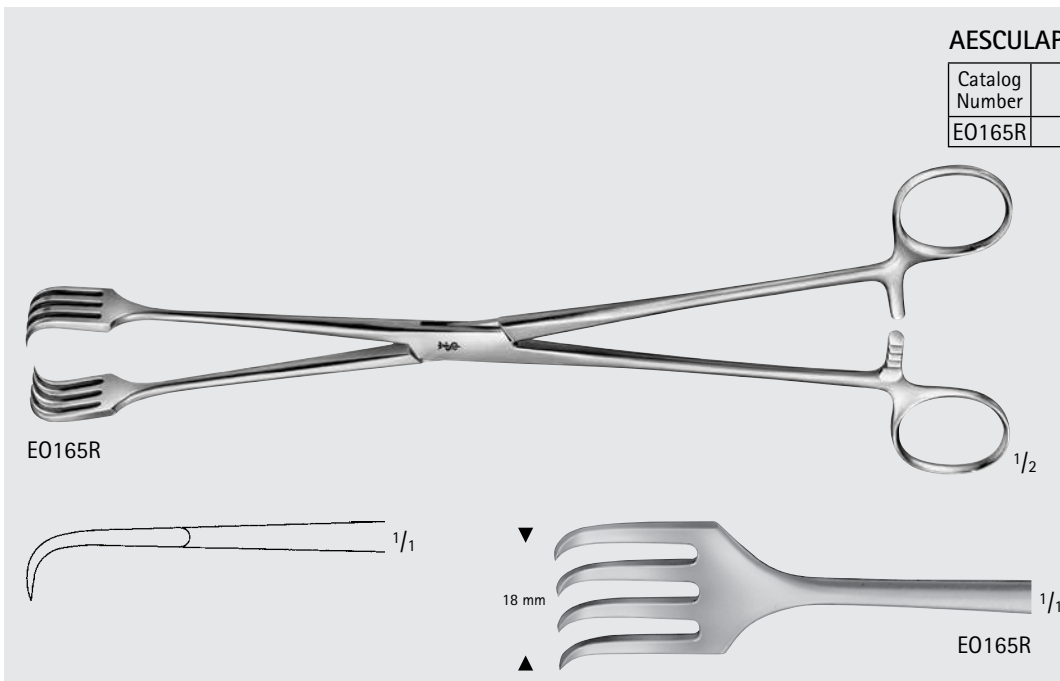

AESCULAP-PRATT Tenaculum Forceps

Catalog Number	Teeth	Length (in.)
EO165R	4 x 4	10 1/4

Obstetrics/Gynecology

Tenaculum and Sponge Forceps

PRATT Tenaculum Forceps

Catalog Number	Teeth	Length (in.)
EO166R	4 x 4	10 5/8



EO166R

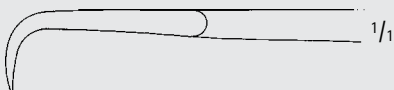

TEALE Tenaculum Forceps

Catalog Number	Teeth	Length (in.)
MG184R	3 x 4	9 5/8
EO180R	3 x 4	10

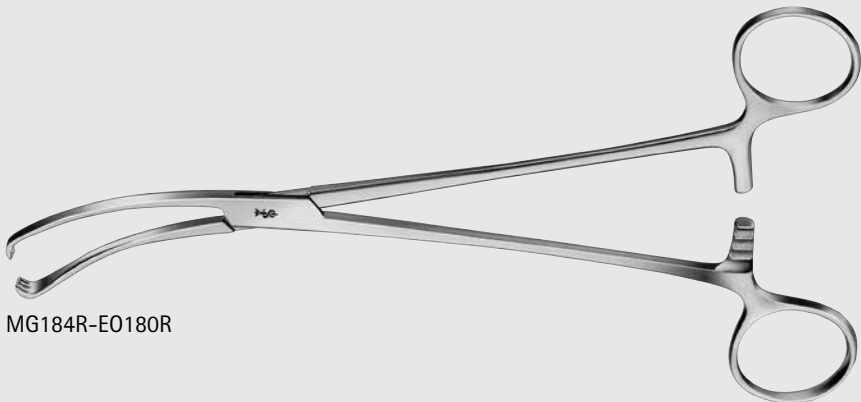

MG184R-EO180R

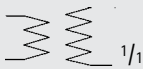

MG184R-EO180R

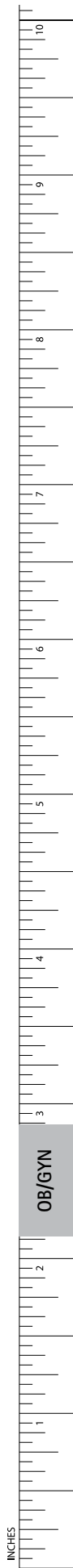

Obstetrics/Gynecology

Tenaculum and Sponge Forceps

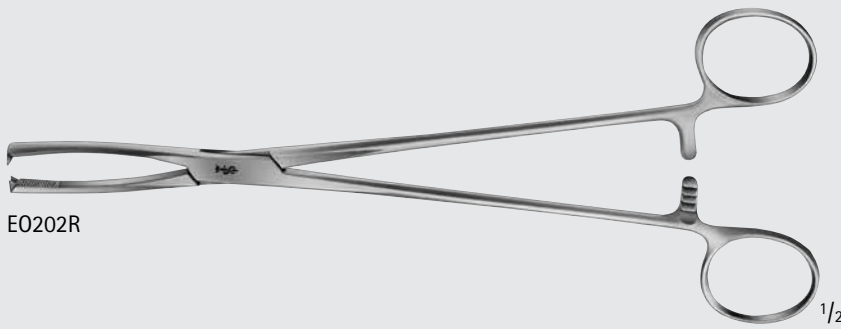

EO202R



EO202R

JACOBS Vulsellum Forceps

Catalog Number	Teeth	Length (in.)
EO202R	2 x 2	8 1/2

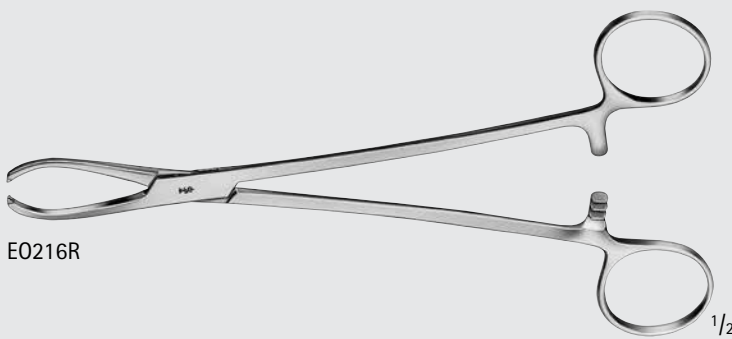

EO216R

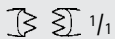

EO216R

LITTLEWOOD Tenaculum Forceps

Catalog Number	Teeth	Length (in.)
EO216R	2 x 3	7 1/4

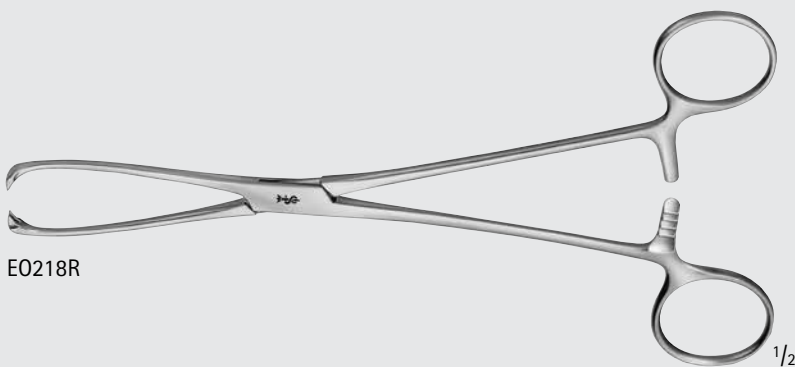

EO218R

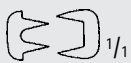

EO218R

MUSEUX Tenaculum Forceps, Small

Catalog Number	Teeth	Length (in.)
EO218R	2 x 2	7 7/8

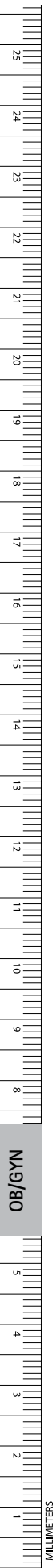

Obstetrics/Gynecology

Tenaculum and Sponge Forceps

MUSEUX Tenaculum Forceps

Catalog Number	Jaw	Length (in.)
E0220R	STR	9 1/2
E0221R	STR	9 1/2
E0222R	STR	9 1/2

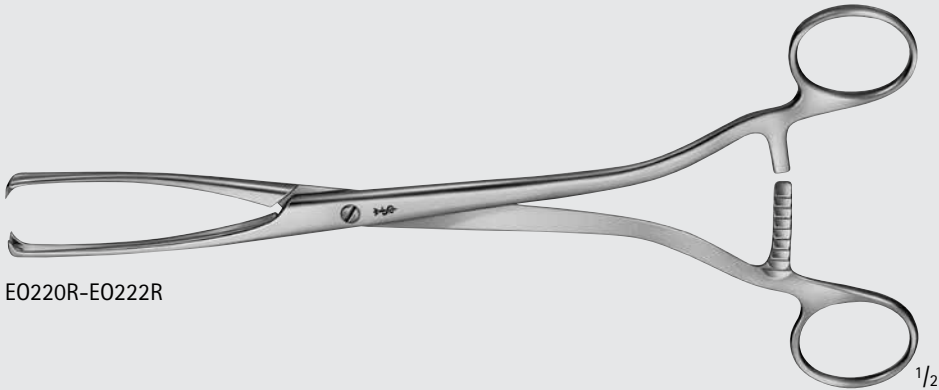

E0220R-E0222R

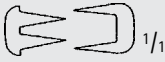

E0220R

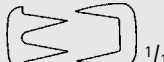

E0221R



E0222R

MUSEUX Tenaculum Forceps

Catalog Number	Jaw	Length (in.)
E0225R	CVD	9 1/2

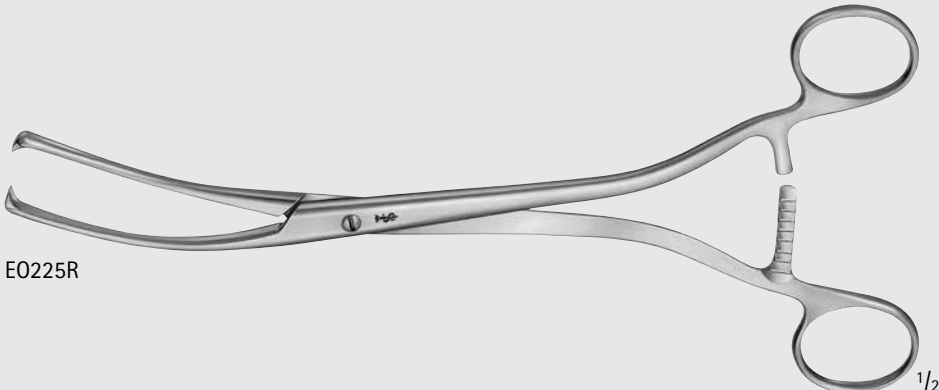

E0225R

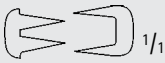

E0225R

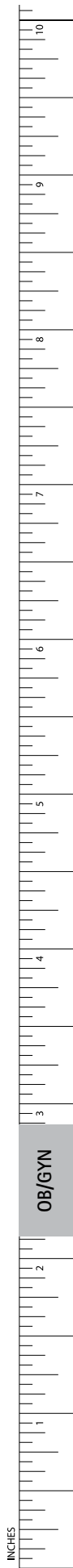

Obstetrics/Gynecology

Tenaculum and Sponge Forceps

MUSEUX Tenaculum Forceps

Catalog Number	Jaw	Size	Length (in.)
E0240R	STR	LARGE	10 1/2
E0242R	STR	X-LARGE	10 1/2

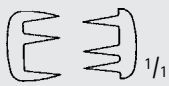
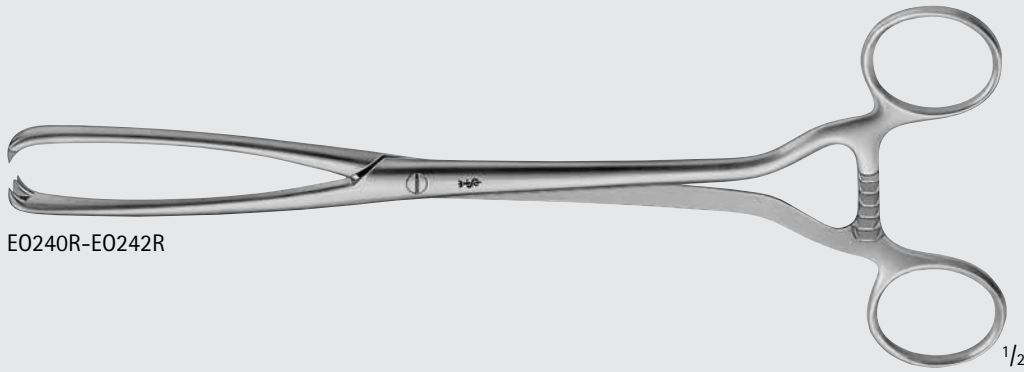

E0240R

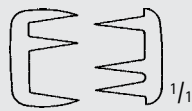

E0242R

FLETCHER-VAN DOREN Uterine Polyp, Sponge Holding Forceps

Catalog Number	Length (in.)
MB273R	9 1/2

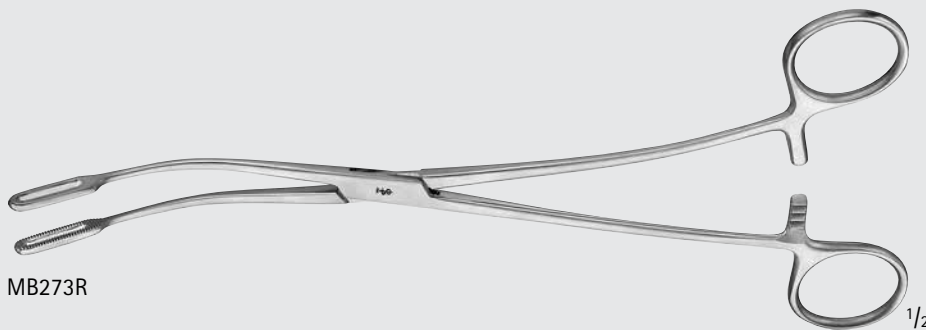

MB273R



MB273R



FLETCHER Sponge Forceps

Catalog Number	Tip	Length (in.)
MG193R	STR	9 3/4

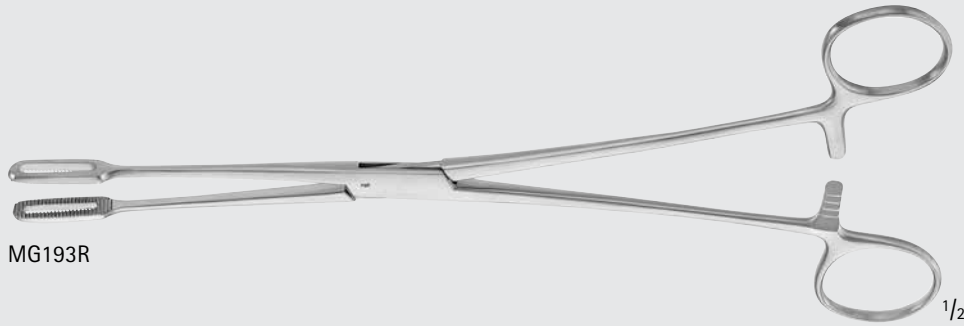

OVERSTREET Endometrial Polyp Forceps

Catalog Number	Jaw	Length (in.)
MG195R	HOLLOW, FENESTRATED	9 1/4

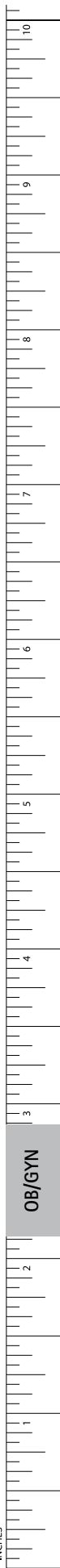
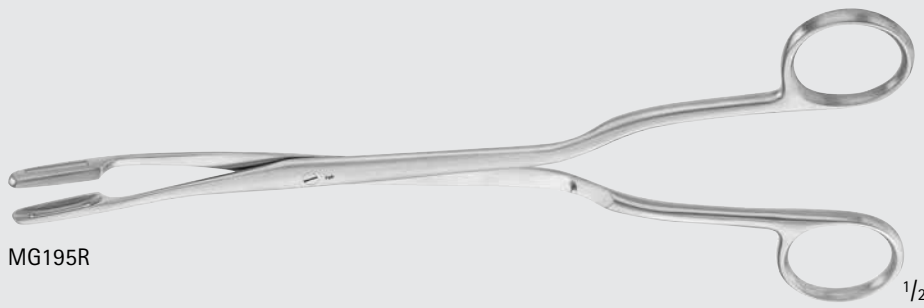

OB/GYN

Obstetrics/Gynecology

Polyp Forceps

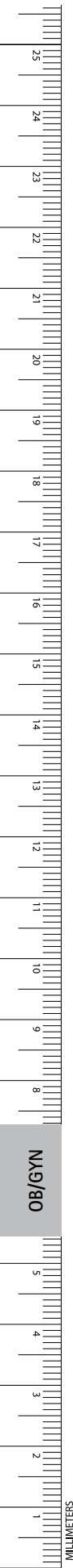

HEYWOOD-SMITH Polyp Forceps

Catalog Number	Length (in.)
EO310R	9 3/4

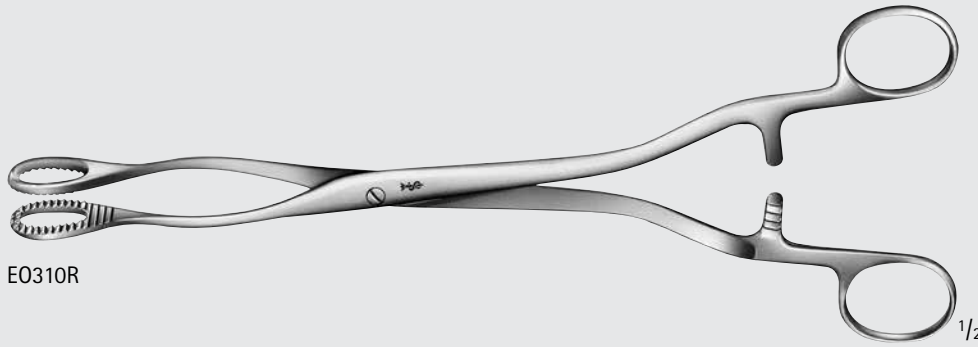

EO310R

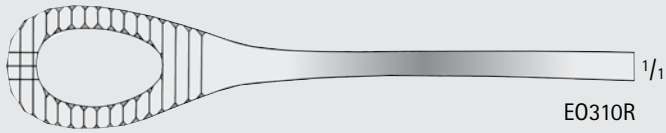

EO310R

NOTO Polyp Forceps

Catalog Number	Length (in.)
EO315R	11

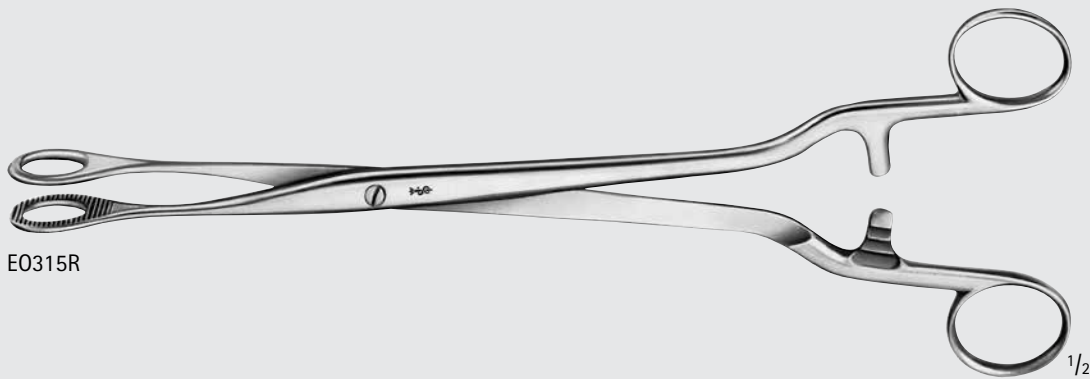

EO315R

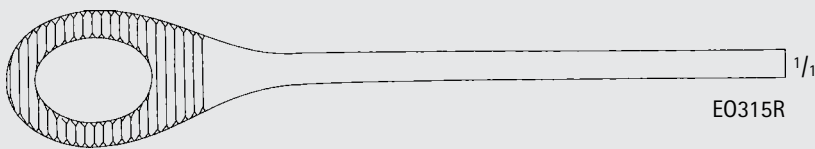

EO315R

DOYEN Ovum Forceps

Catalog Number	Length (in.)
E0332R	7 1/4

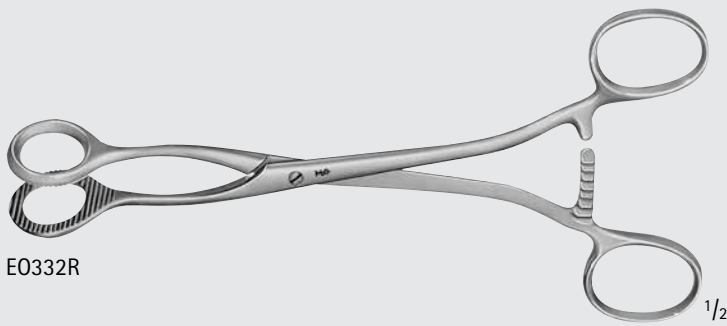

E0332R

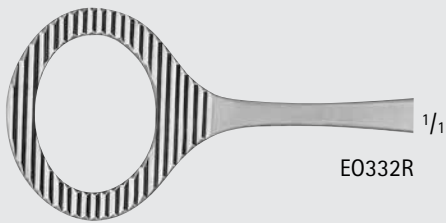

E0332R

Atraumatic Ovum Forceps

Catalog Number	Tip	Length (in.)
E0338R	SMALL	9 3/4

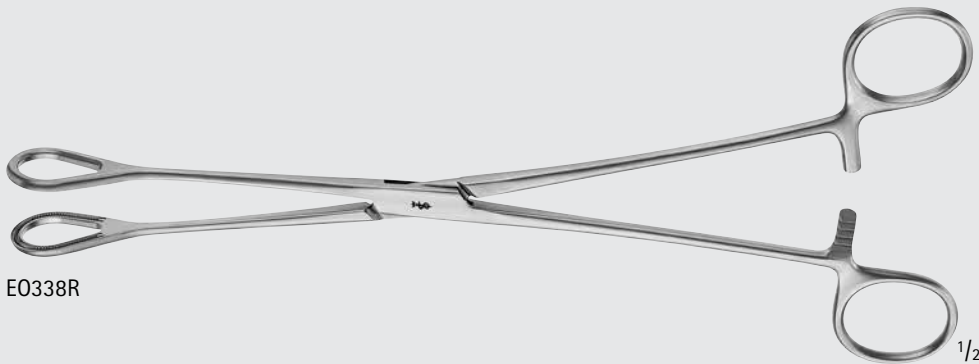

E0338R

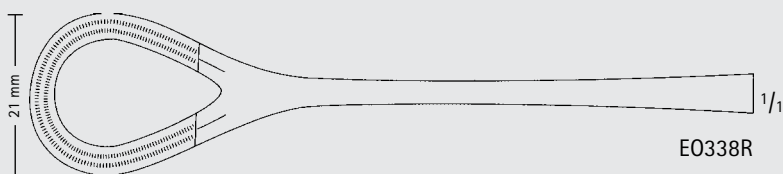

E0338R

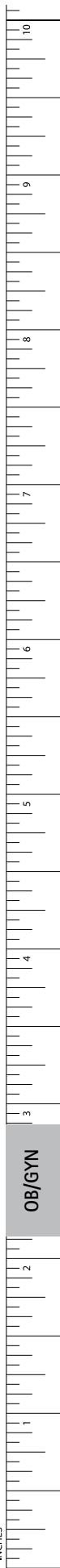

OB/GYN

INCHES

Obstetrics/Gynecology

Uterine Elevating Forceps

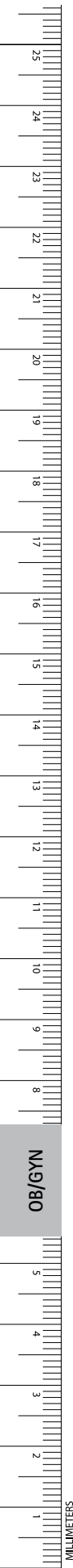

DARTIGUES Elevating Forceps

Catalog Number	Length (in.)
EO407R	10

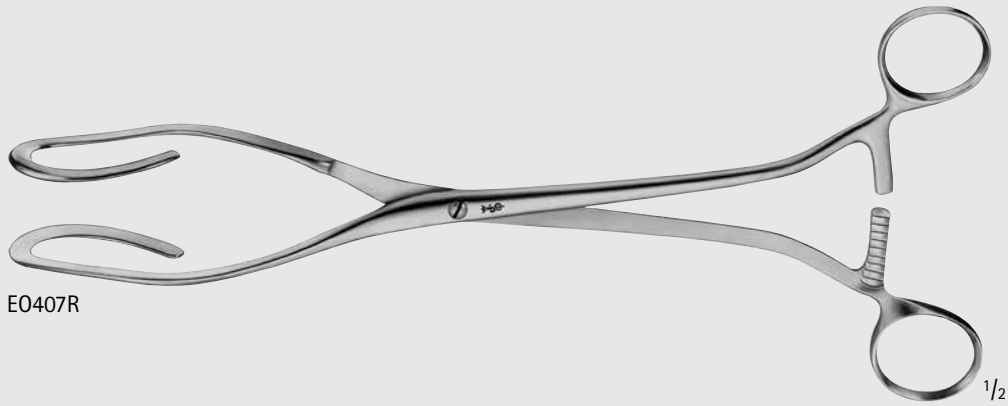

EO407R

SOMER Uterine Elevating Forceps

Catalog Number	Length (in.)
EO415R	9 1/4

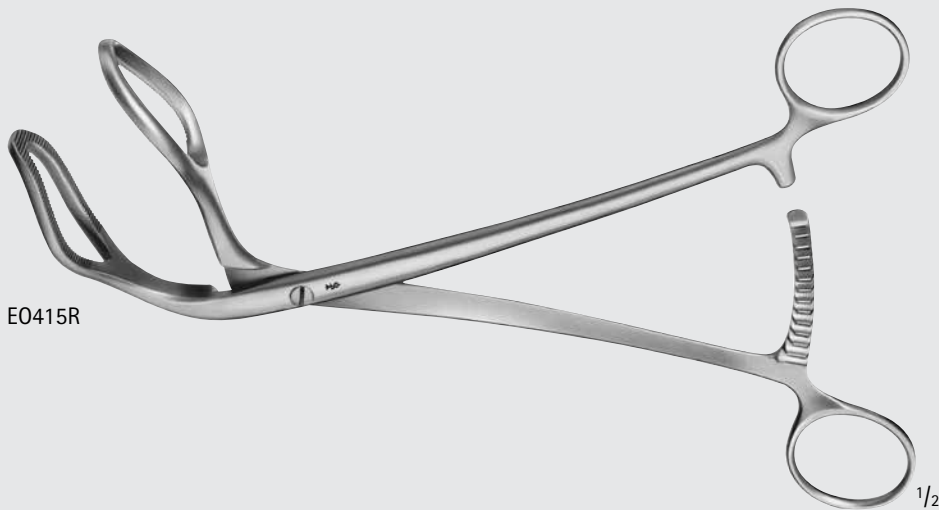

EO415R

Obstetrics/Gynecology
Uterine Elevating Forceps

COLLIN Uterine Elevating Forceps

Catalog Number	Length (in.)
EO405R	11 1/4

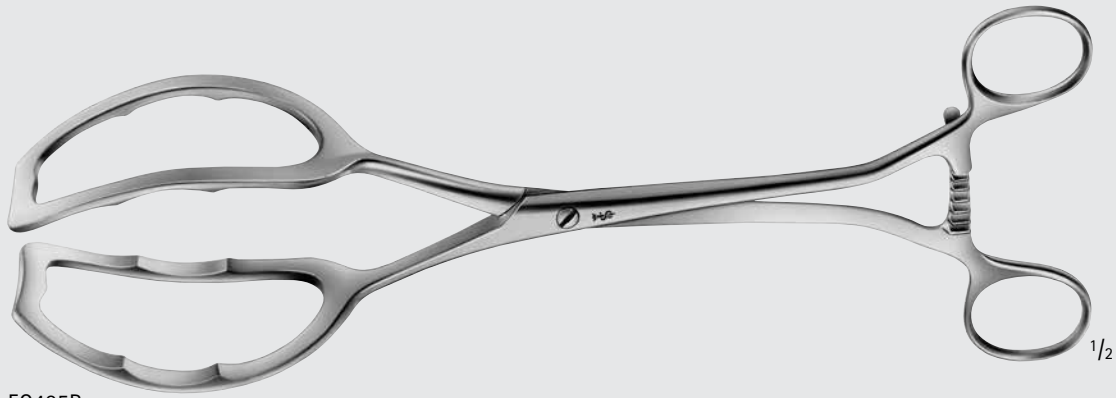

EO405R

COLLIN Uterine Elevating Forceps,
Movable Jaw

Catalog Number	Blade	Length (in.)
EO420R	STR	10 1/2

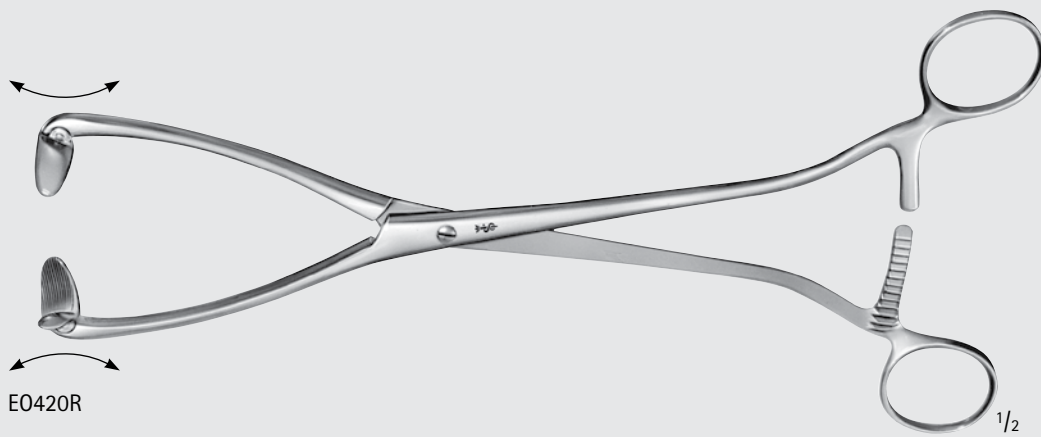

EO420R

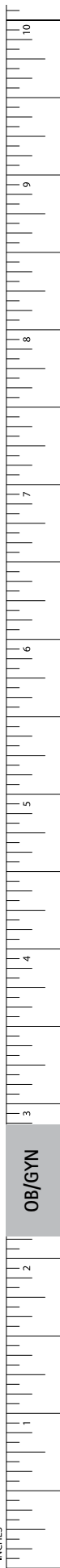

Obstetrics/Gynecology

Uterine Elevating and Membrane Forceps

HULKA-KENWICK Uterine Elevating Forceps

Catalog Number	Length (in.)
E0422R	10 3/4

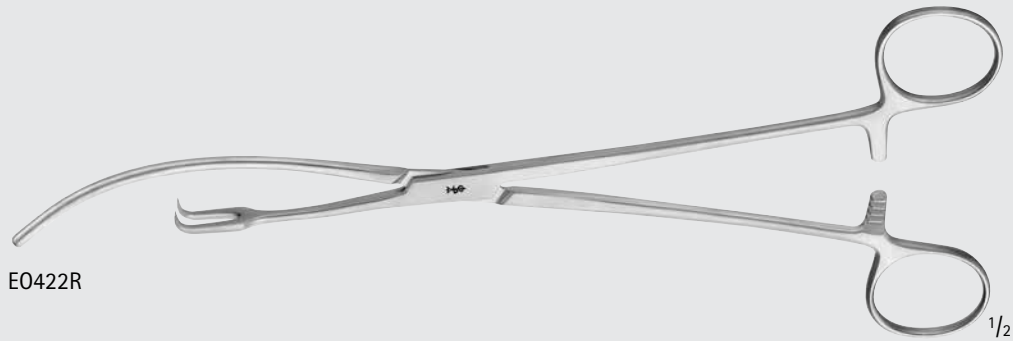

IOWA Membrane Puncturing Forceps

Catalog Number	Length (in.)
MG189R	10

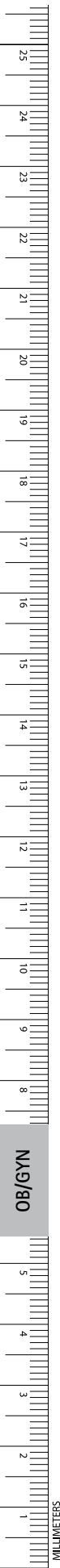
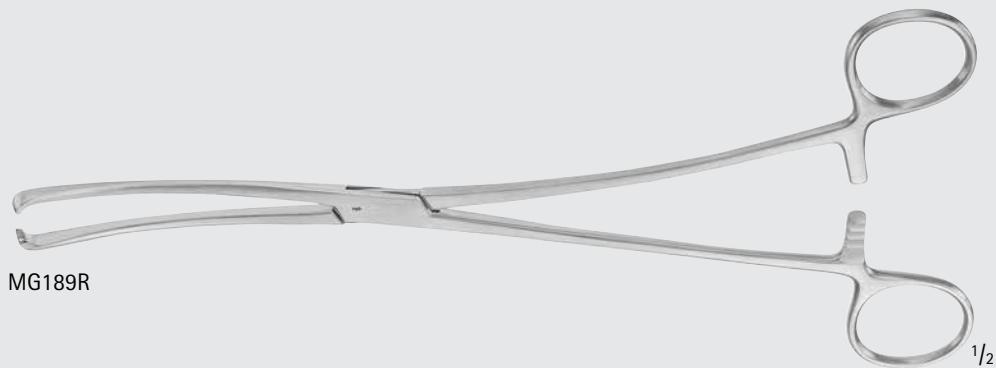

DOYEN Myoma Screw

Catalog Number	Length (in.)
E0433R	6
E0435R	7 1/2

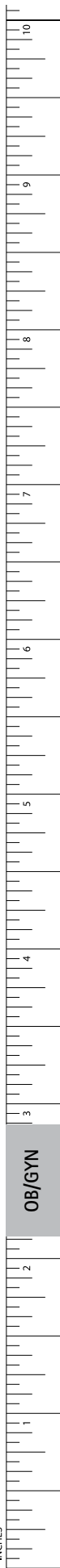
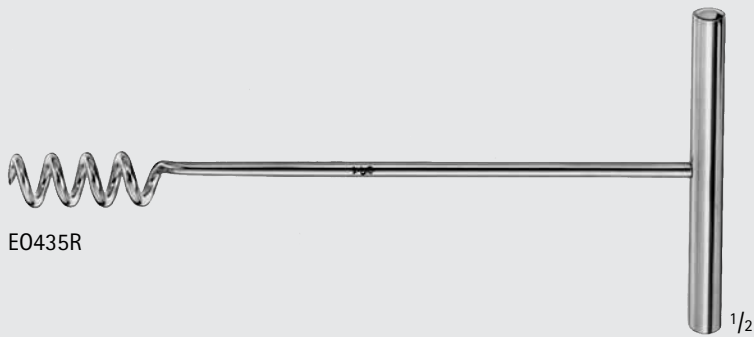

Obstetrics/Gynecology

Obstetrical Forceps

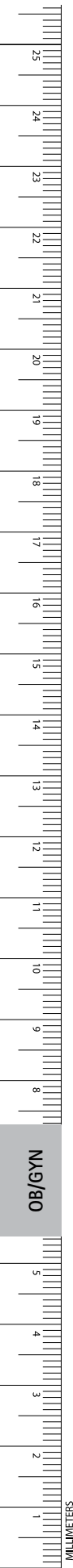

NAEGELE Obstetrical Forceps

Catalog Number	Length (in.)
ET205R	14

ET205R $\frac{1}{3}$

Detailed description: A pair of obstetrical forceps with long, curved blades and a single handle with a bulbous grip. The blades are designed for fetal extraction. The handle has a small circular detail near the base.

KIELLAND Obstetrical Forceps

Catalog Number	Length (in.)
ET210R	16 1/2

ET210R $\frac{1}{3}$

Detailed description: A pair of obstetrical forceps with long, curved blades and two handles. The blades are designed for fetal extraction. The handles have a serrated grip and a locking mechanism in the middle.

SIMPSON-BRAUN Obstetrical Forceps

Catalog Number	Length (in.)
ET220R	12
ET221R	13 3/4

ET220R $\frac{1}{3}$

ET221R $\frac{1}{3}$

Detailed description: Two pairs of obstetrical forceps. The top pair (ET220R) has long, curved blades and a single handle with a bulbous grip. The bottom pair (ET221R) has long, curved blades and a single handle with a serrated grip. Both are designed for fetal extraction.



DE LEE Obstetrical Forceps

Catalog Number	Length (in.)
MG190R	12
MG185R	14

MG190R-MG185R



ELLIOTT Obstetrical Forceps

Catalog Number	Length (in.)
MG191R	15

MG191R

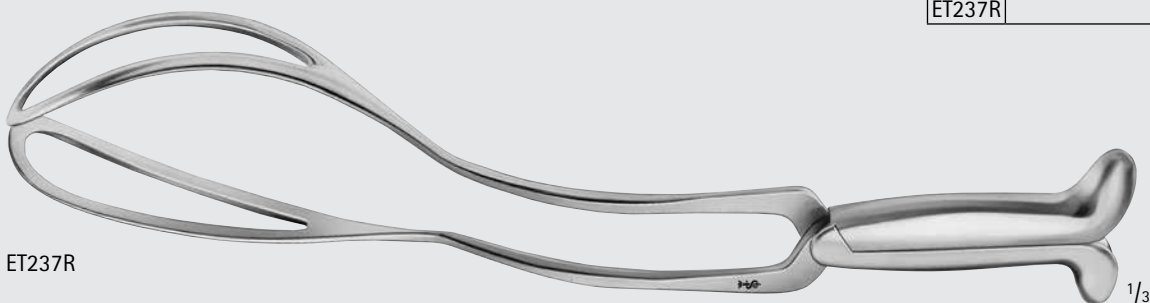

PIPER Obstetrical Forceps, F/ Breach

Catalog Number	Length (in.)
ET237R	17 1/2

ET237R

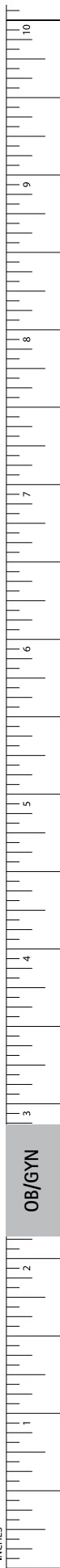

OB/GYN

INCHES

Obstetrics/Gynecology

Obstetrical Forceps



ET245R

SIMPSON C-Section Forceps

Catalog Number	Length (in.)
ET245R	9 1/4

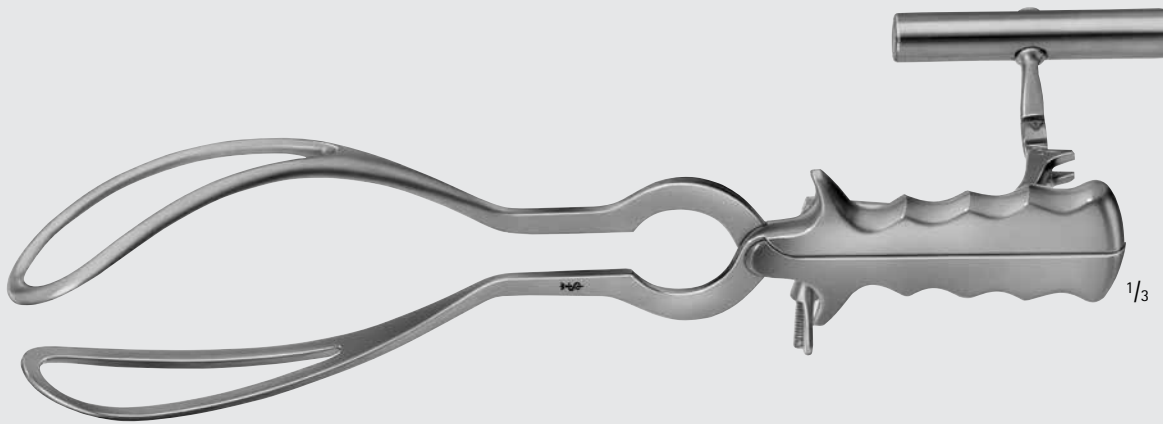

ET255R

BARNES-NEVILLE Obstetrical Forceps, With Traction Handle

Catalog Number	Length (in.)
ET255R	17 1/8

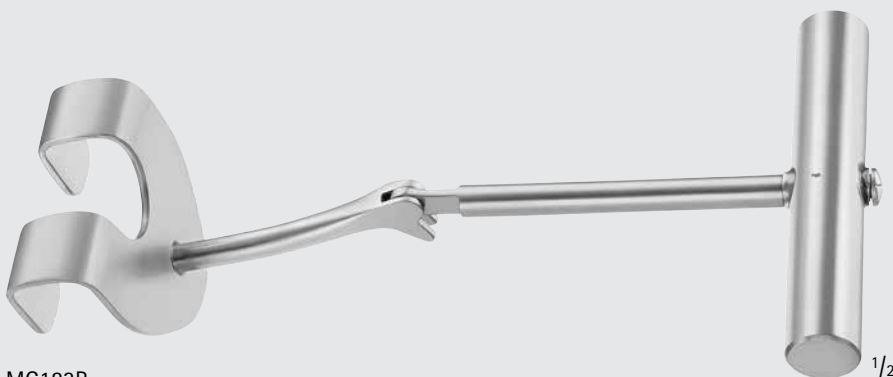

MG183R

BILL Traction Handle

Catalog Number	Description
MG183R	FOR USE W/ STANDARD OB FORCEPS



LUIKART-SIMPSON Obstetrical Forceps

Catalog Number	Length (in.)
MB298R	14



MB298R

LUIKART-MCLANE Obstetrical Forceps

Catalog Number	Length (in.)
MB299R	15 1/2



MB299R

LUIKART-KIELLAND Obstetrical Forceps

Catalog Number	Length (in.)
MB069R	15 1/2

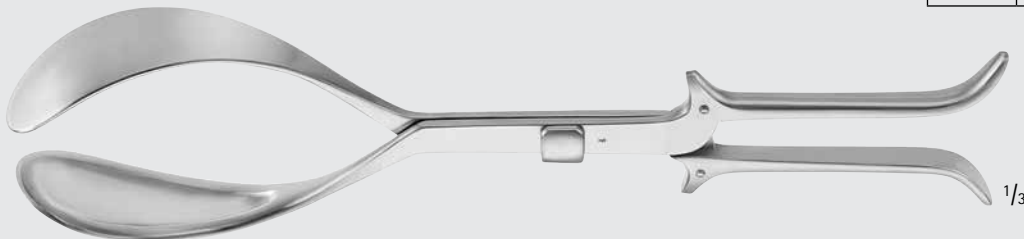

MB069R

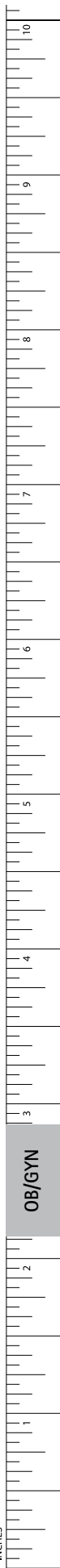

Obstetrics/Gynecology

Obstetrical Forceps and Head Extractor

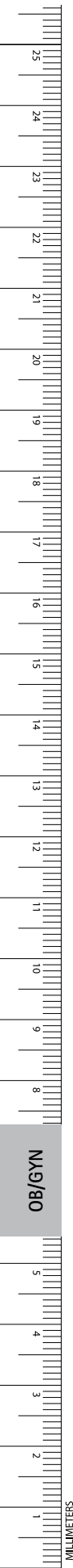

LUIKHART Obstetrical Forceps

Catalog Number	Length (in.)
MG186R	16



MG186R

MCLANE-TUCKER Obstetrical Forceps

Catalog Number	Length (in.)
MG192R	16 1/4



MG192R

MURLESS Head Extractor

Catalog Number	Length (in.)
MG492R	10



MG492R

Obstetrics/Gynecology

C-Section Forceps and Obstetric Lever

SELLHEIM Obstetric Lever

Catalog Number	Blade	Length (in.)
ET270R	OPEN	11 3/4



ET270R

1/2



ET270R

1/2

GREEN-ARMYTAGE Forceps, F/ C-Section

Catalog Number	Length (in.)
ET269R	8 3/4

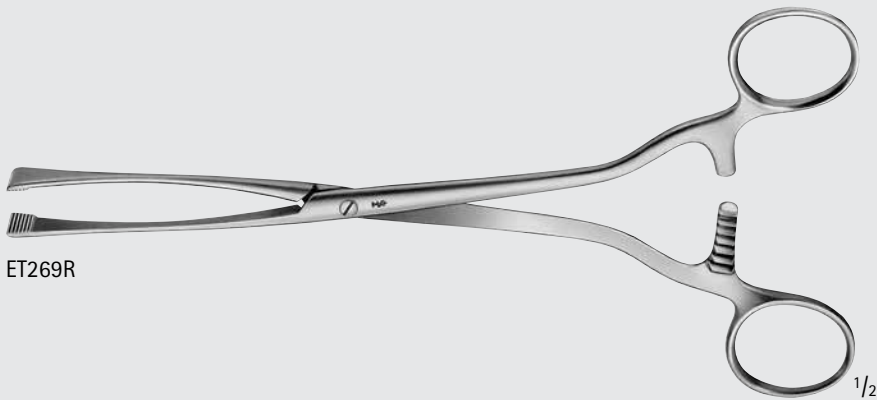

ET269R

1/2



ET269R

1/1

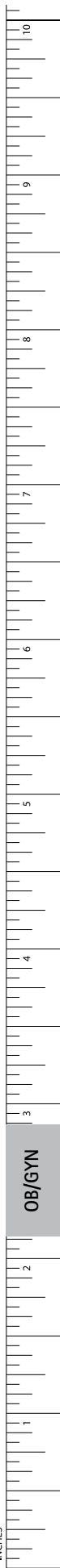

Obstetrics/Gynecology

Placenta and Ovum Forceps

BARRETT Placenta Forceps

Catalog Number	Blade	Length (in.)
MG201R	FENESTRATED	10



BIERER Ovum Forceps

Catalog Number	Jaw (mm)	Ratchet	Length (in.)
MG466R	16	NO	11
MG467R	16	YES	11
MG468R	19	NO	11
MG469R	19	YES	11

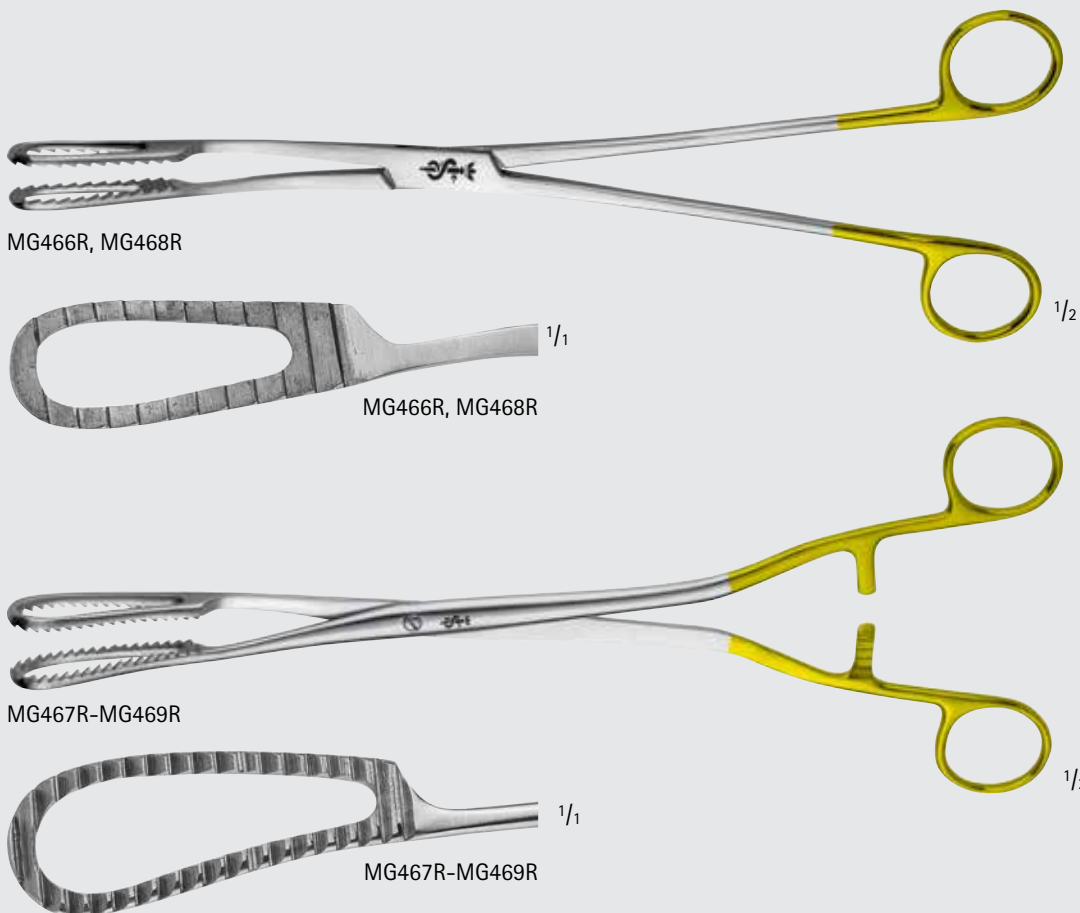

Obstetrics/Gynecology
Placenta and Ovum Forceps

WINTER Placenta and Ovum Forceps,
W/O Ratchet

Catalog Number	Size (#)	Jaw	Length (in.)
ET301R	1	STR	11 1/2
ET302R	2	STR	11 1/2



ET301R-ET302R



ET301R



ET302R

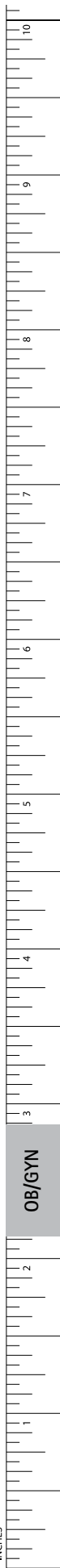

Obstetrics/Gynecology

Placenta and Ovum Forceps

WINTER Placenta and Ovum Forceps, W/O Ratchet (continued)

Catalog Number	Size (#)	Jaw	Length (in.)
ET306R	1	CVD	11 1/2
ET307R	2	CVD	11 1/2
ET308R	3	CVD	11 1/2



ET306R-ET308R



ET306R

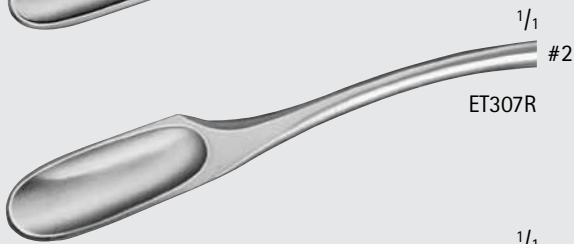

ET307R



ET308R

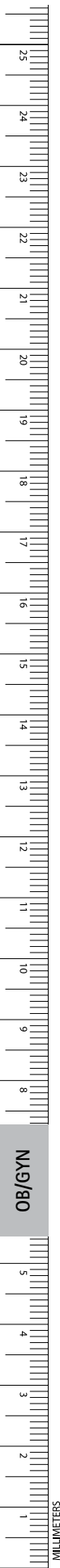

OB/GYN

Obstetrics/Gynecology

Placenta and Ovum Forceps

WINTER Placenta and Ovum Forceps, W/ Ratchet

Catalog Number	Size (#)	Jaw	Length (in.)
ET315R	2	CVD	11 1/2
ET316R	3	CVD	11 1/2

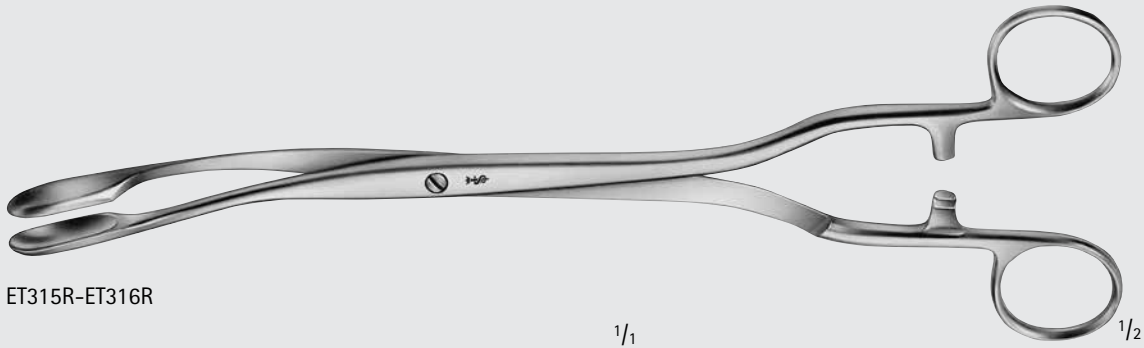

ET315R-ET316R

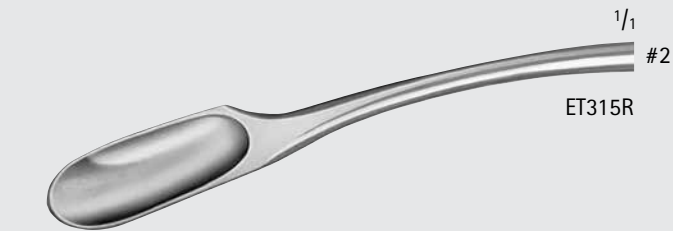

ET315R

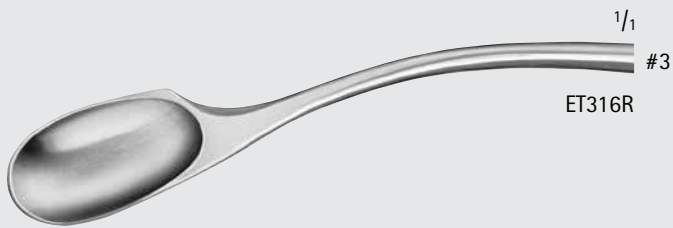

ET316R

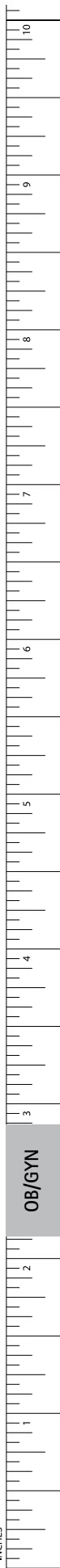

Obstetrics/Gynecology

Placenta and Ovum Forceps

SAENGER Placenta and Ovum Forceps, W/ Ratchet

Catalog Number	Jaw	Length (in.)
ET326R	STR	10 3/4
ET327R	CVD	10 1/2
ET325R	CVD	11 1/4

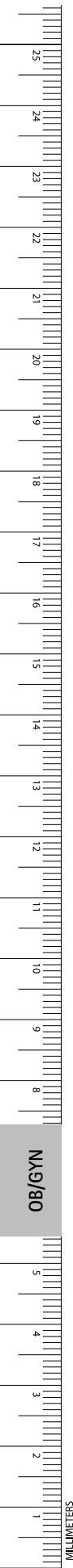
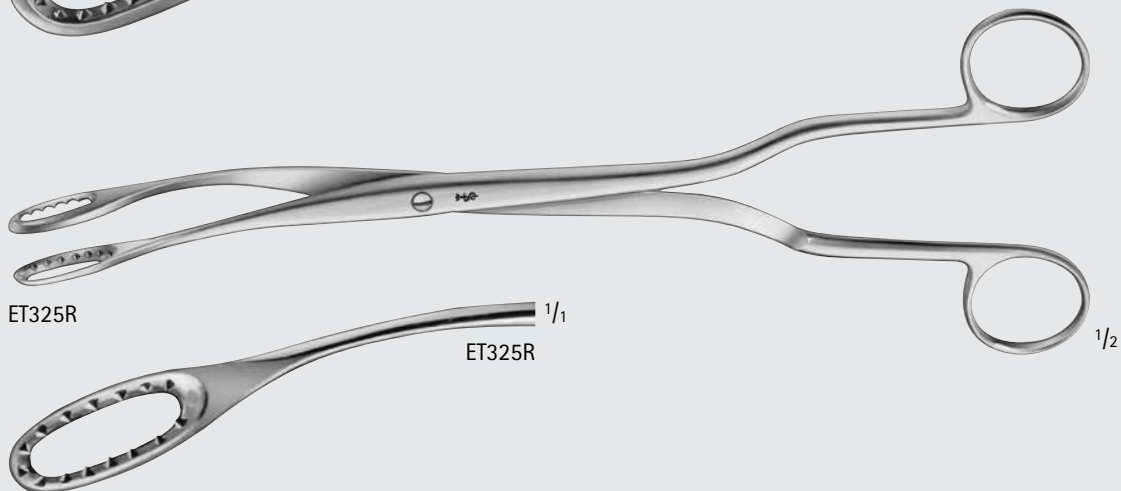
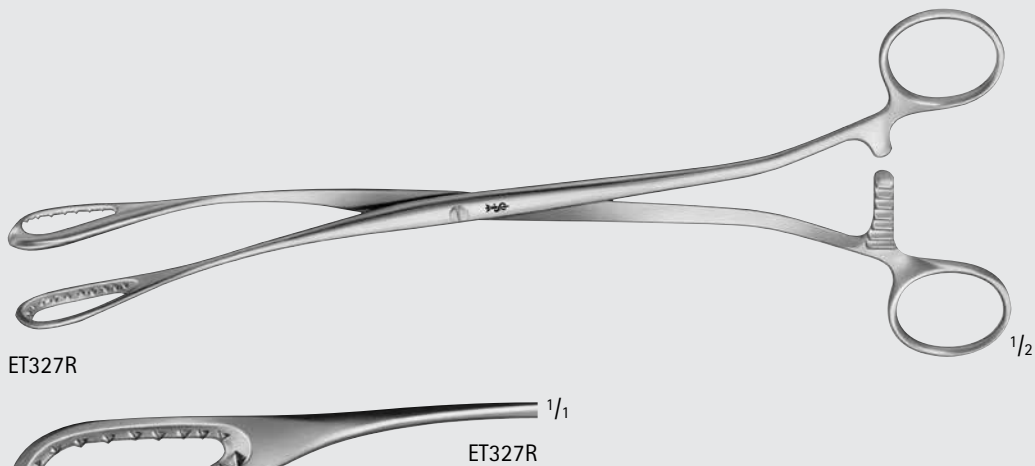
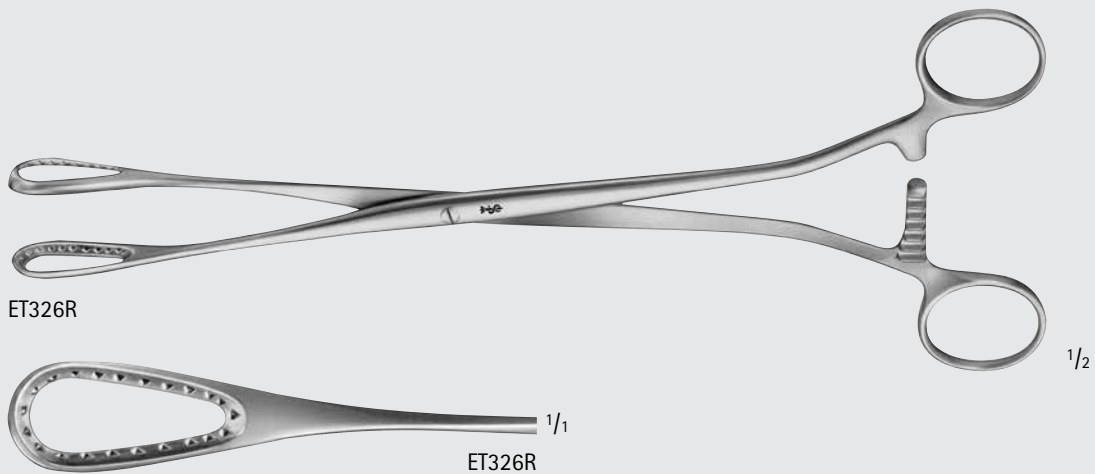

Obstetrics/Gynecology
Placenta and Ovum Forceps

MCCLINTOCK Placenta and Ovum
Forceps

Catalog Number	Length (in.)
ET329R	9 1/2

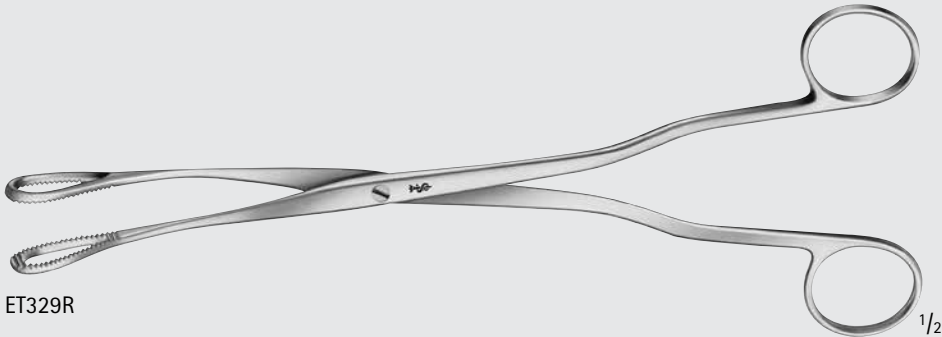

ET329R

1/2



ET329R

1/1



Obstetrics/Gynecology

Biopsy Forceps

THOMS-GAYLOR Biopsy Forceps, S-Shape

Catalog Number	Length (in.)
ER050R	9 1/2

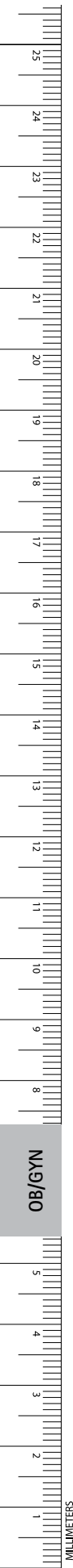
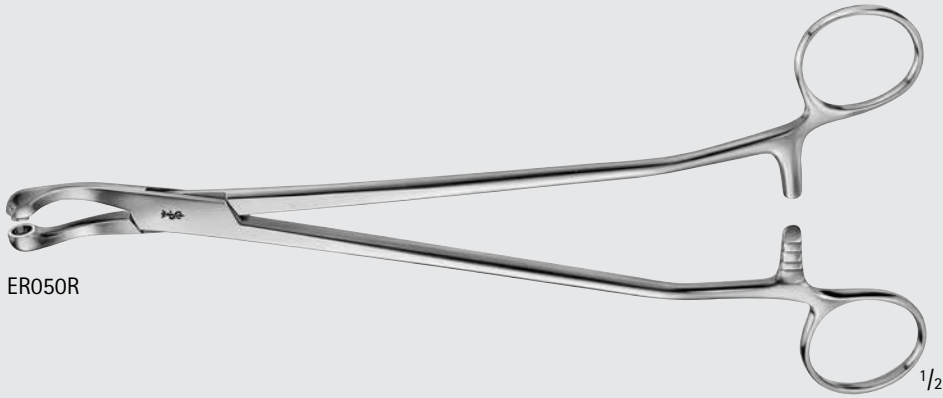

SCHUMACHER Biopsy Forceps, S-Shape

Catalog Number	Tip	Length (in.)
ER061R	SMALL	9 1/2
ER062R	LARGE	9 1/2

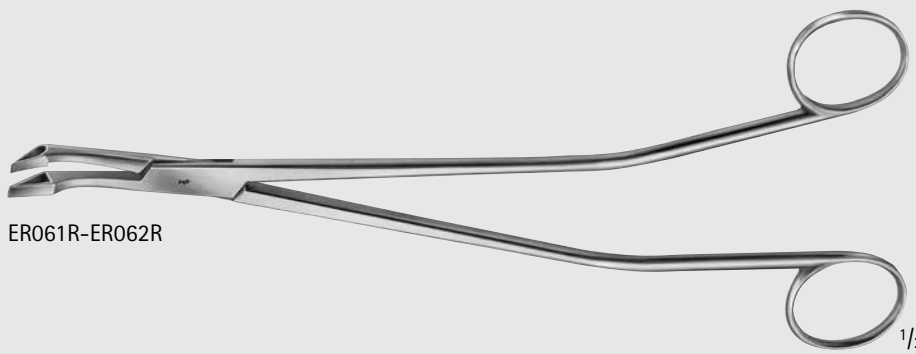

ER061R-ER062R



ER061R



ER062R

SCHUMACHER Biopsy Rongeur

Catalog Number	Tip	Length (in.)
ER063R	SMALL	9 1/2
ER064R	LARGE	9 1/2

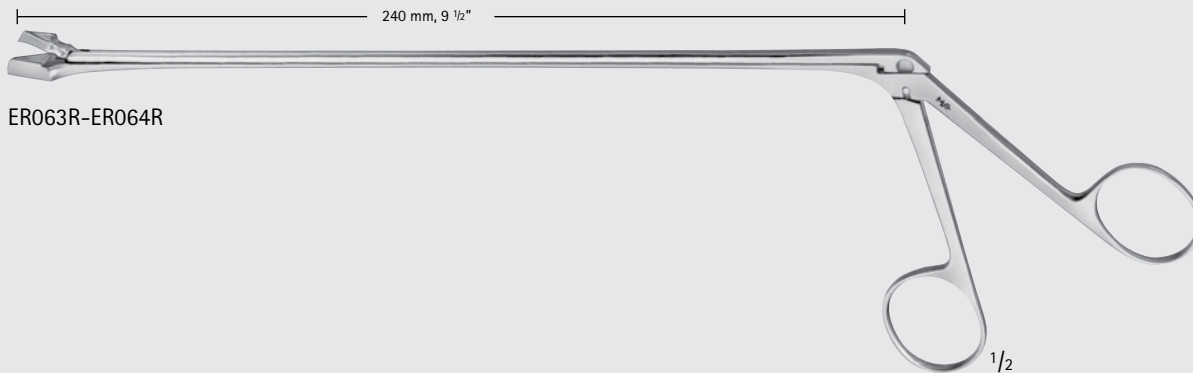

ER063R-ER064R



ER063R



ER064R

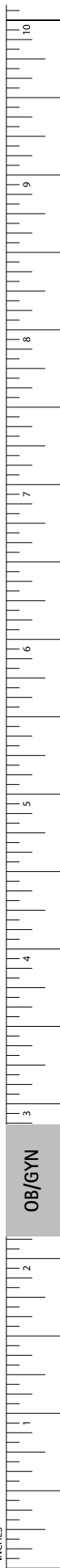

INCHES

Obstetrics/Gynecology

Biopsy Forceps

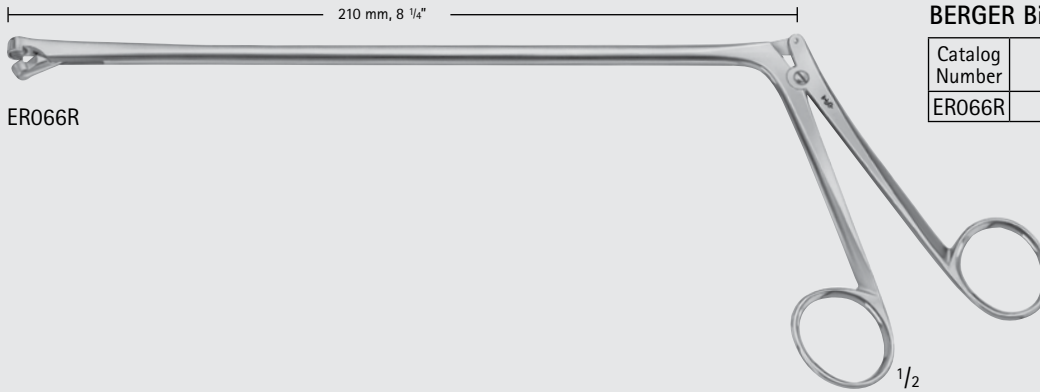

BERGER Biopsy Forceps

Catalog Number	Length (in.)
ER066R	8 1/4



TISCHLER Cervical Biopsy Punch Forceps

Catalog Number	Jaw Size (mm)	Working Length (in.)
ER068R	5 x 6 x 3	8 1/4
MG187R	7 x 3	11

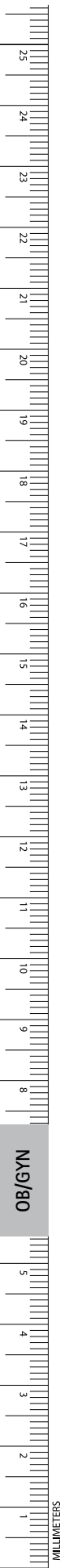
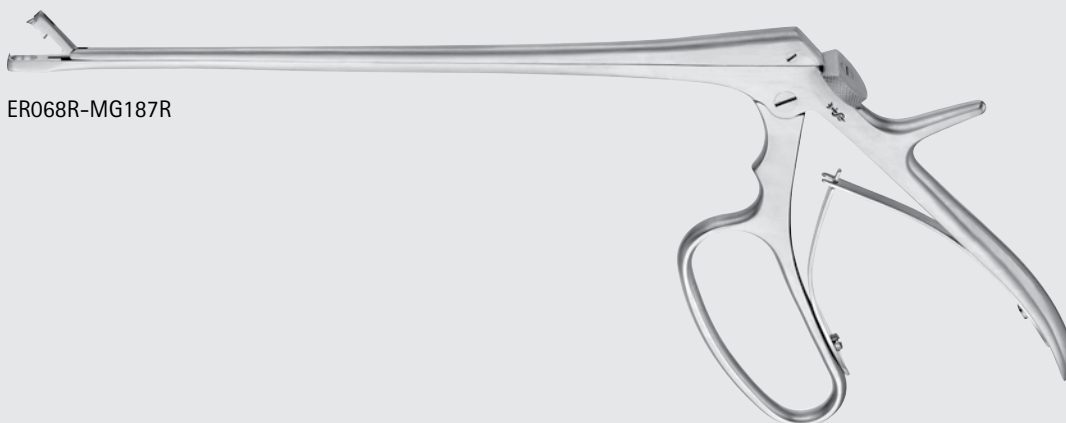

TISCHLER Biopsy Alligator Forceps

Catalog Number	Jaw	Jaw Size (mm)	Length (in.)
MG076R	OBLONG CUP SINGLE TOOTH	7 x 3	9 3/4



MG076R

1/2



MG076R

1/1

KEVORKIAN-YOUNGE Biopsy Forceps

Catalog Number	Jaw Size (mm)	Working Length (in.)
ER080R	8.5 x 3.5	10

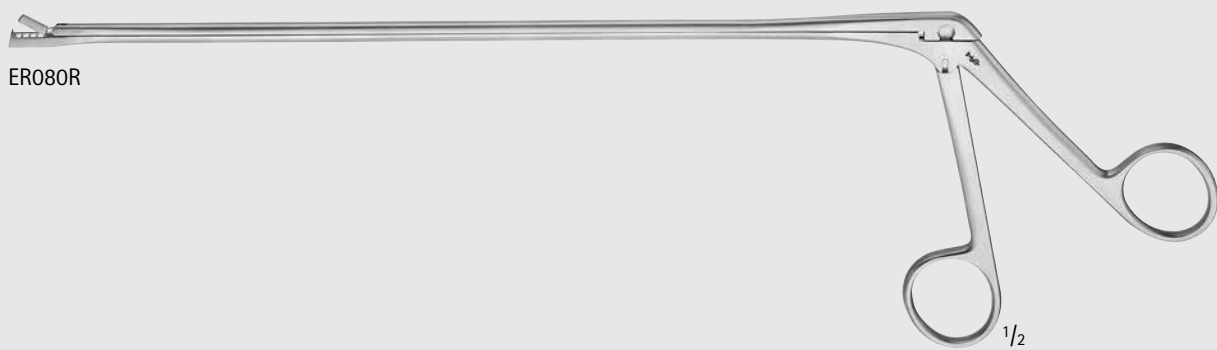

ER080R

1/2



ER080R

1/1

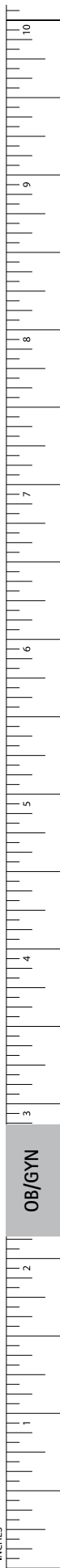

OB/GYN

INCHES

Obstetrics/Gynecology

Biopsy Forceps

WITTNER Biopsy Forceps

Catalog Number	Jaw	Jaw Size (mm)	Working Length (in.)
MG194R	STR. JAWS W/ TEETH	4 x 8	9



EPPENDORF Biopsy Forceps

Catalog Number	Jaw Size (mm)	Working Length (in.)
ER070R	8 x 4	8

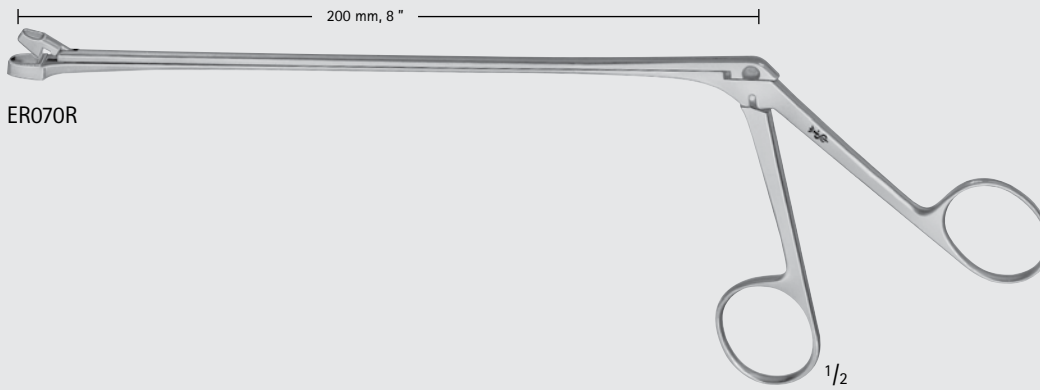

PHANEUF Hysterectomy Forceps

Catalog Number	Jaw	Length (in.)
BJ500R	STR	8 1/4
BJ501R	ANG	8

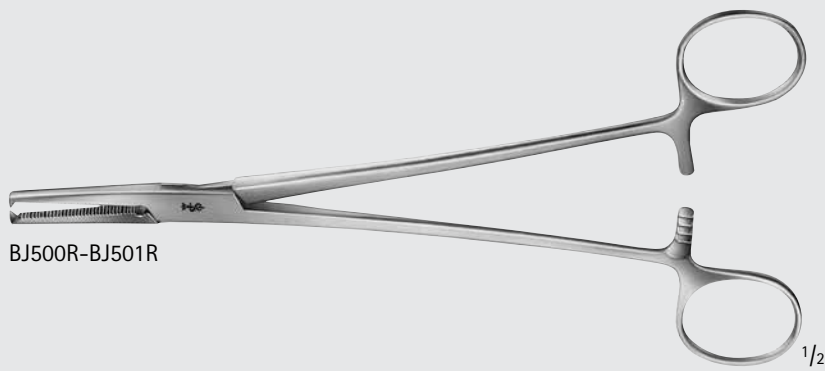

BJ500R-BJ501R



BJ500R



BJ501R

HOLZBACH Hysterectomy Forceps

Catalog Number	Jaw	Length (in.)
BJ510R	STR	9 5/8
BJ511R	CVD	9 5/8

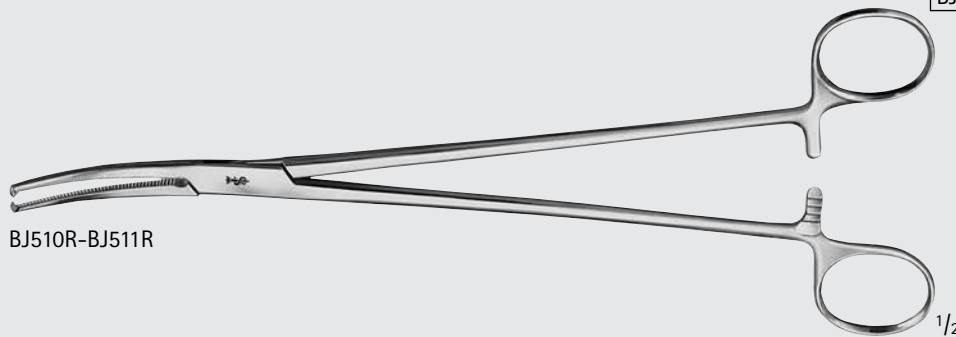

BJ510R-BJ511R



BJ510R



BJ511R

HEANEY-REZEK Hysterectomy Forceps

Catalog Number	Jaw	Length (in.)
BJ524R	STR	8 1/4

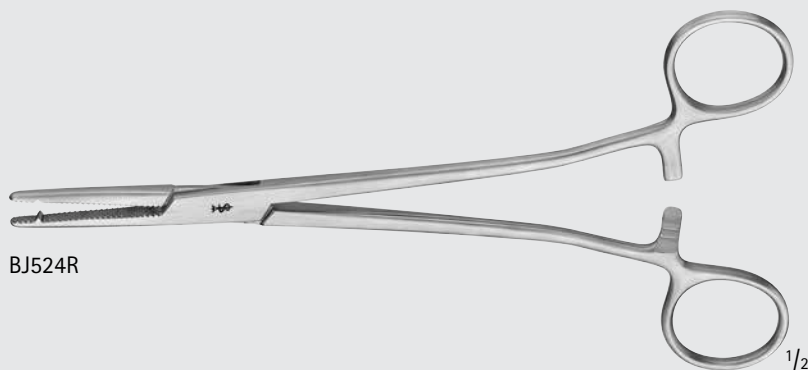

BJ524R



BJ524R

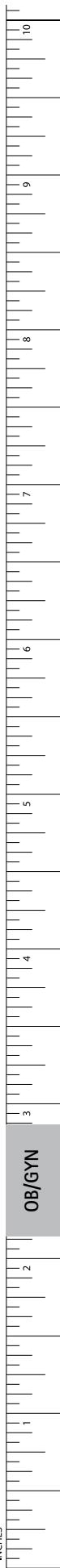

OB/GYN

INCHES

Obstetrics/Gynecology

Clamps

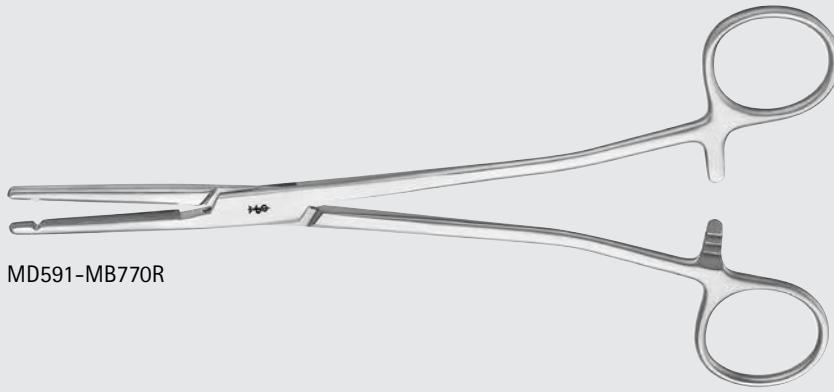

MD591-MB770R



MD591

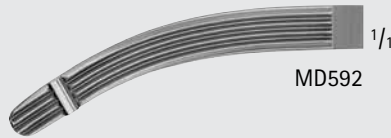

MD592

HEANEY-BALLENTINE Hysterectomy Forceps, Longitudinal Grooves

Catalog Number	Jaw	Length (in.)
MD591	STR	8 1/2
MB757R	STR	10 1/2
MB754R	STR	12
MB771R	STR	14
MD592	CVD	8 1/2
MB749R	CVD	10 1/2
MB753R	CVD	12
MB770R	CVD	14

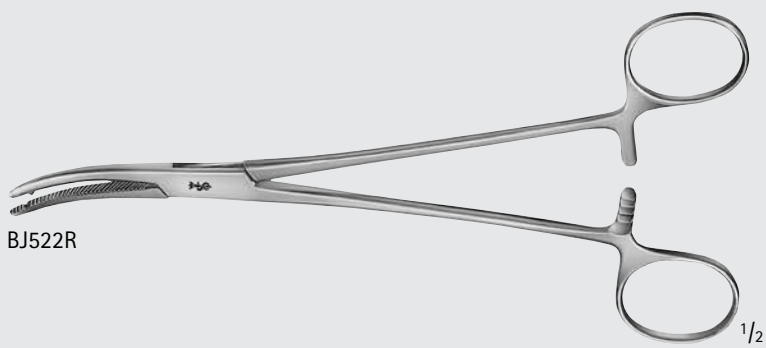

BJ522R

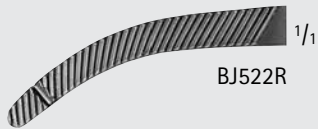

BJ522R

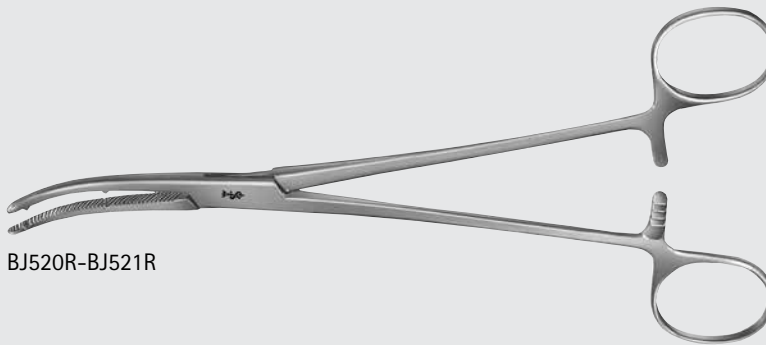

BJ520R-BJ521R

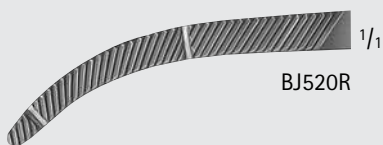

BJ520R

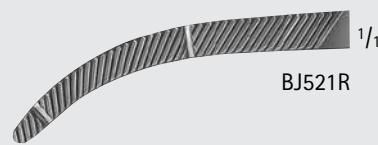

BJ521R

HEANEY Hysterectomy Forceps

Catalog Number	Jaw	Teeth	Length (in.)
BJ522R	CVD	1	7 3/4
BJ520R	CVD	2	8
BJ521R	CVD	2	9 3/4

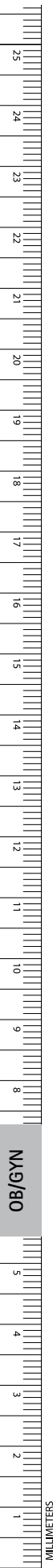

OB/GYN

HEANEY Hysterectomy Forceps
(continued)

Catalog Number	Jaw	Teeth	Length (in.)
MB906R	STR	2	12
MB907R	CVD	2	12

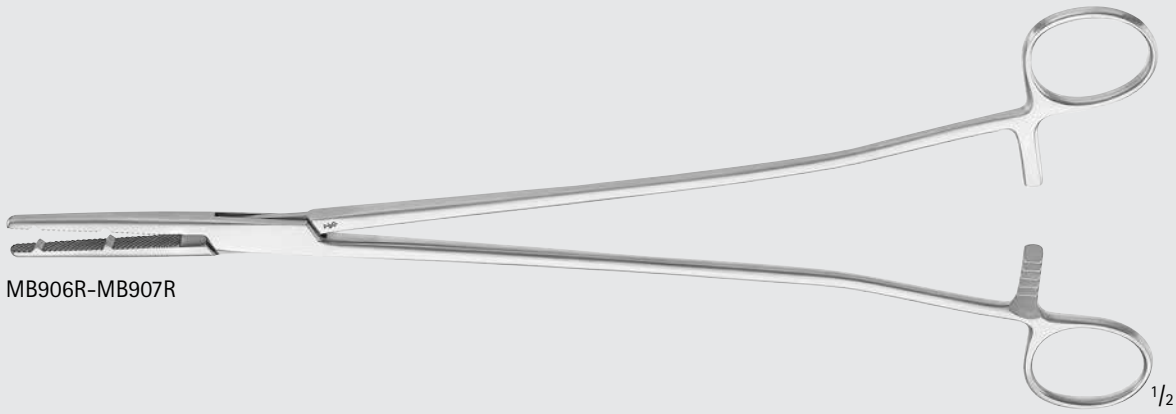

MB906R-MB907R



MB906R



MB907R

HEANEY Hysterectomy Forceps, Heavy

Catalog Number	Jaw	Length (in.)
MB797R	CVD	8 1/4

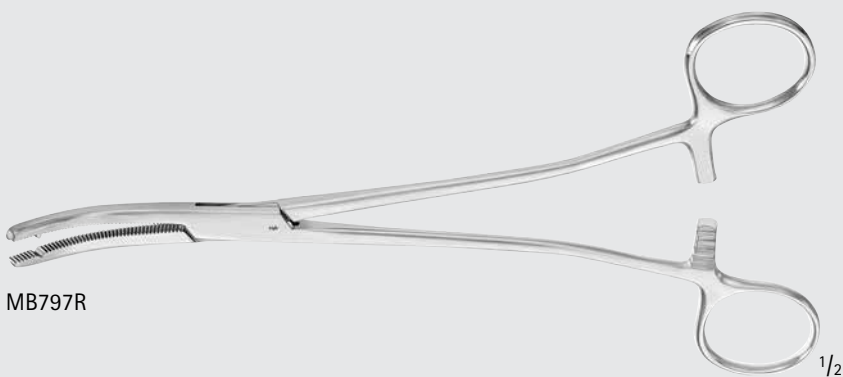

MB797R

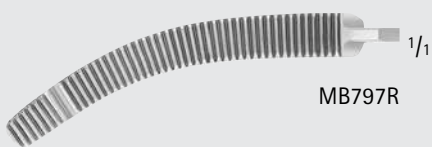

MB797R

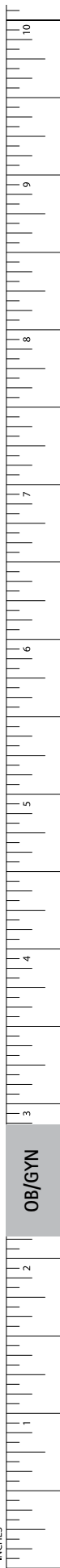

Obstetrics/Gynecology

Clamps

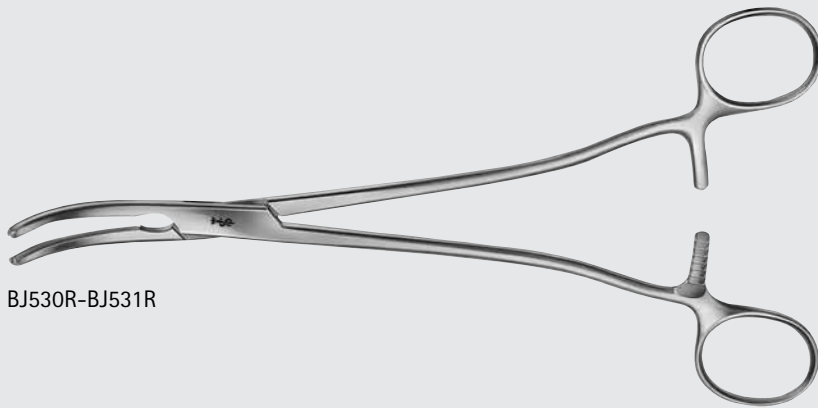

BJ530R-BJ531R

HEANEY Hysterectomy Forceps, W/O Teeth

Catalog Number	Jaw	Length (in.)
BJ530R	STR	8 7/8
BJ532R	CVD	8 1/2
BJ531R	CVD	8 3/4



BJ530R

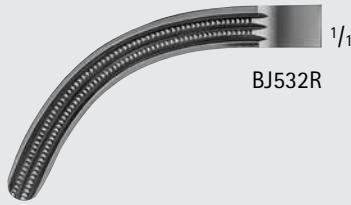

BJ532R

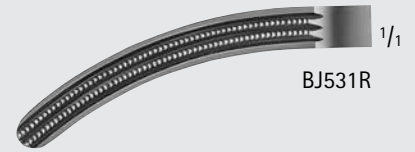

BJ531R

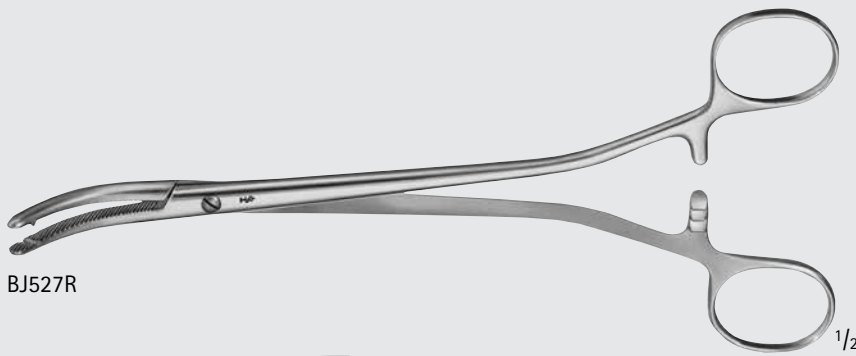

BJ527R

WIENER Hysterectomy Forceps, W/ Grooves

Catalog Number	Tip	Jaw	Length (in.)
BJ527R	SMOOTH	CVD	9 1/2

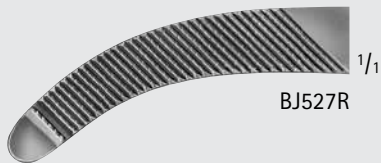

BJ527R

OB/GYN

WERTHEIM Atraumatic Parametrium Clamp

Catalog Number	Jaw	Length (in.)
BJ550R	STR	9 3/4
BJ551R	SLT-CVD	9 5/8
BJ552R	CVD	9 1/2
BJ553R	UP-CVD	8 3/4

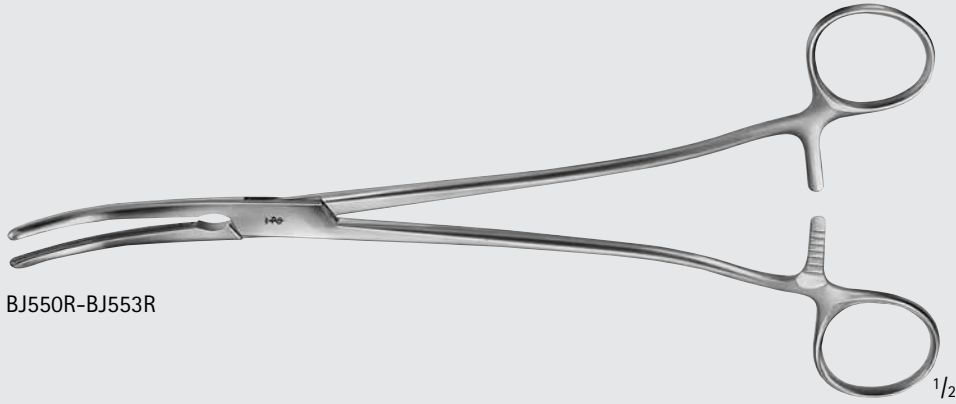

BJ550R-BJ553R



BJ550R

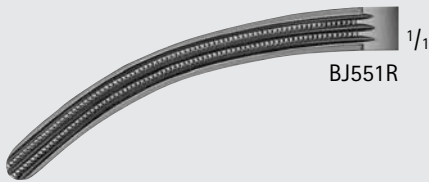

BJ551R



BJ552R

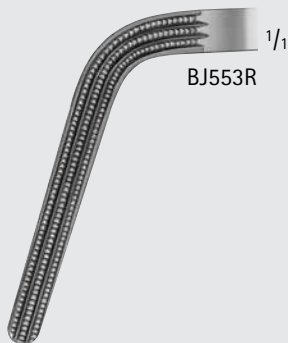

BJ553R



Obstetrics/Gynecology

Clamps

WERTHEIM Parametrium Clamp

Catalog Number	Jaw	Length (in.)
BJ576R	CVD	10 1/4

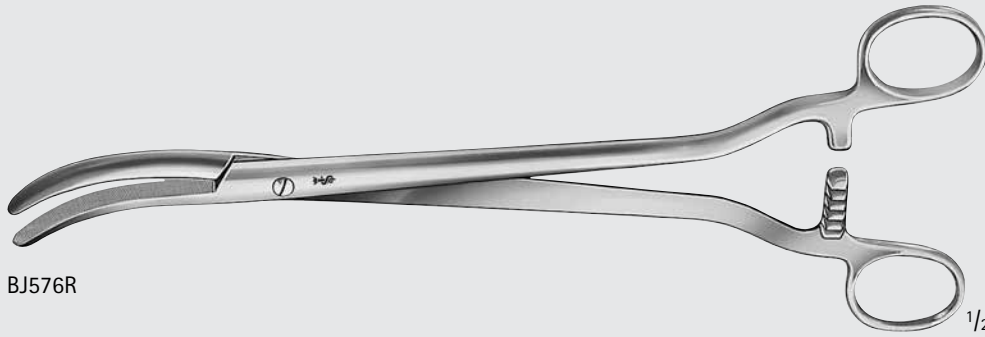

BJ576R

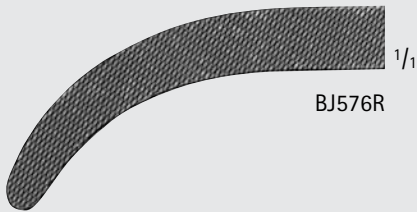

BJ576R

WERTHEIM Hysterectomy Forceps

Catalog Number	Jaw	Length (in.)
BJ574R	CVD	10

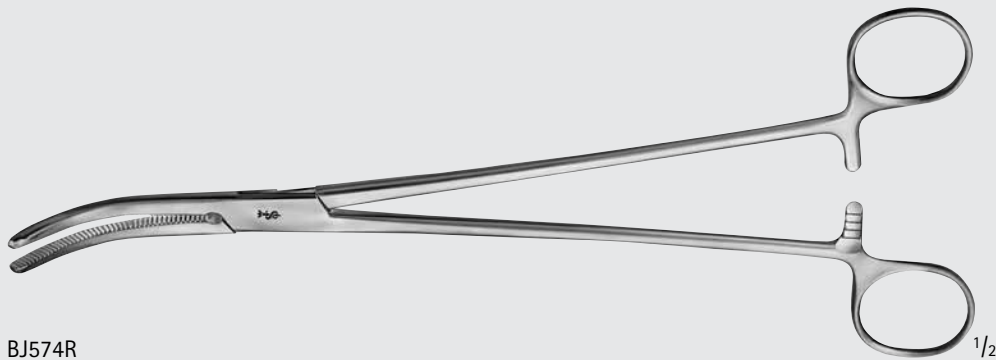

BJ574R

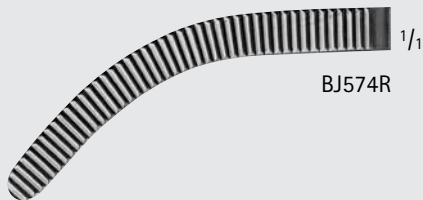

BJ574R

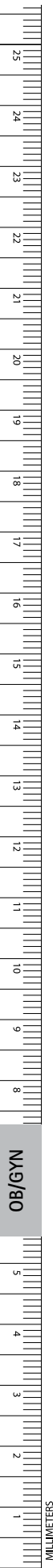

WERTHEIM-CULLEN Clamp

Catalog Number	Jaw	Length (in.)
BJ579R	RIGHT-ANG	8 1/2

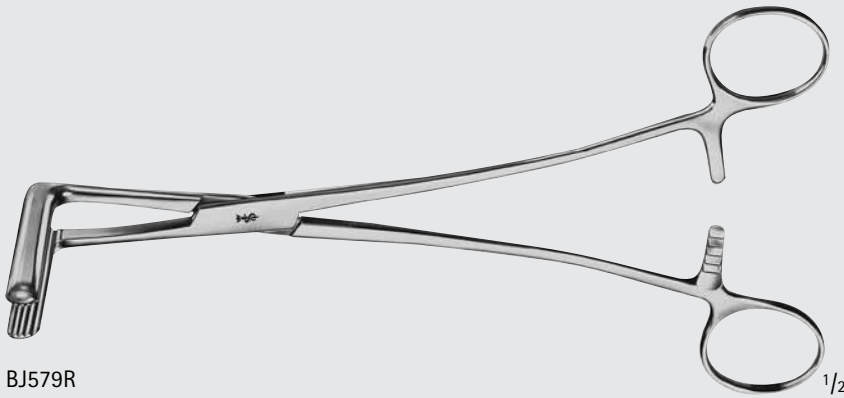

WERTHEIM Atraumatic Clamp

Catalog Number	Jaw	Length (in.)
BJ581R	RIGHT-ANG	9 3/4

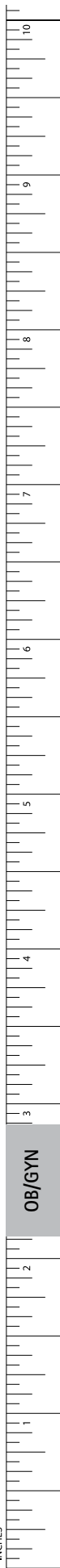
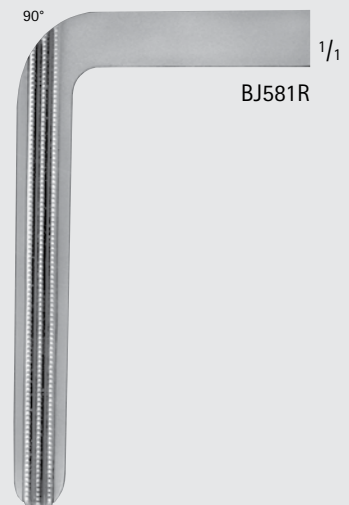
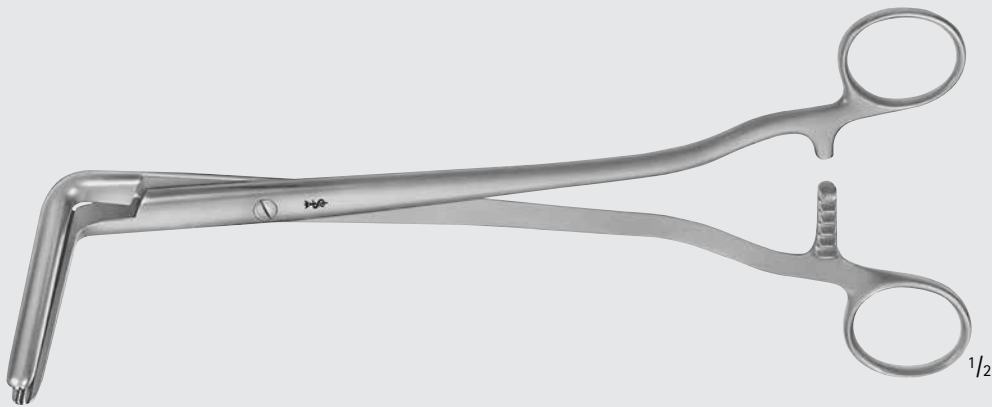

Obstetrics/Gynecology

Clamps

GLASSMAN Anterior Resection Clamp

Catalog Number	Jaw	Jaw Length (mm)	Length (in.)
MB931R	90°, SERR	25	9 3/4
MB130R	90°, SERR	50	9 3/4
MB932R	90°, SERR	75	10

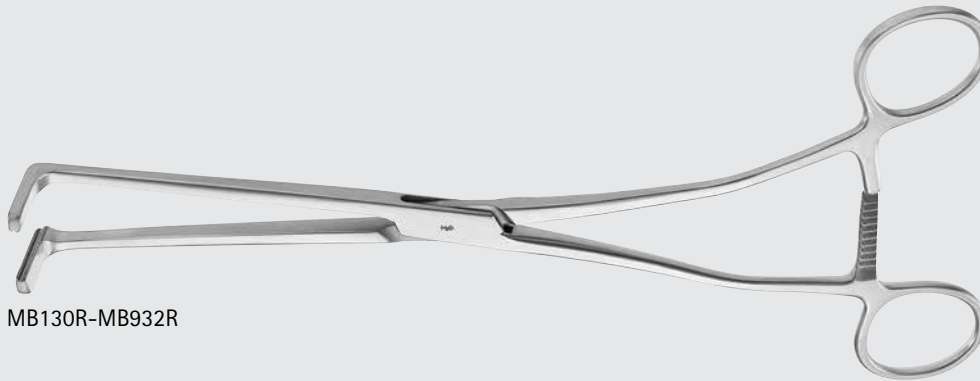

MB130R-MB932R



MB931R

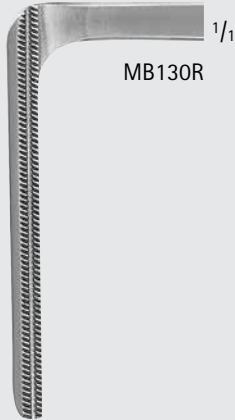

MB130R

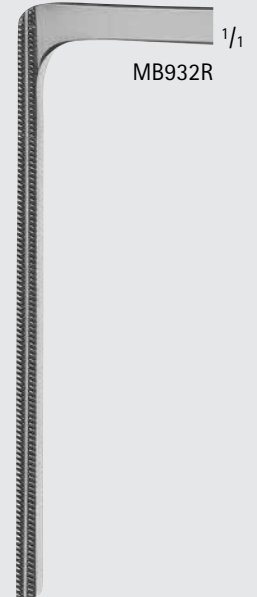

MB932R

MASTERSON Uterine Clamp

Catalog Number	Jaw	Length (in.)
MG198R	STR	8 1/2
MG199R	CVD	8 1/2

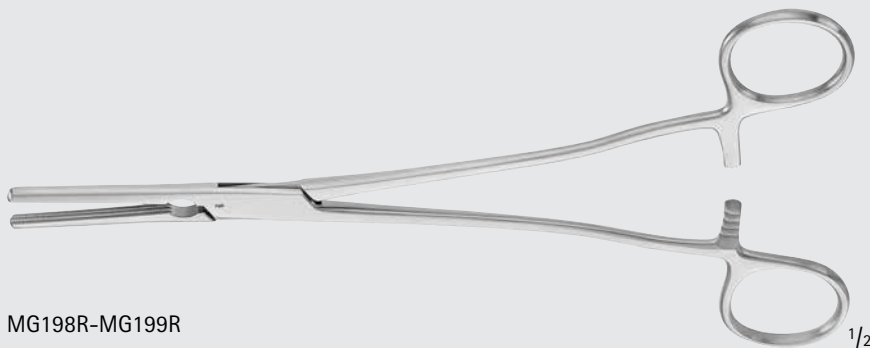

MG198R-MG199R



MG198R



MG199R

OB/GYN

Z-Type Hysterectomy Clamp

Catalog Number	Jaw	Handle	Length (in.)
MG203R	STR	STR	8 1/2
MG204R	SLIGHT-CVD	STR	8 1/2
MG205R	CVD	STR	8 1/2
MG206R	ANG	STR	8 1/2
MB352R	STR	STR	9 1/2
MB353R	SLIGHT-CVD	STR	9 1/2
MB354R	CVD	STR	9 1/2
MB355R	ANG	STR	9 1/2
MB786R	STR	ANG	9 1/2
MB787R	SLIGHT-CVD	ANG	9 1/2
MB788R	CVD	ANG	9 1/2
MB789R	ANG	ANG	9 1/2
MB187R	STR	STR	12
MB188R	SLIGHT-CVD	STR	12
MB183R	CVD	STR	12
MB184R	ANG	STR	12
MB790R	STR	ANG	12
MB792R	SLIGHT-CVD	ANG	12
MB793R	CVD	ANG	12
MB794R	ANG	ANG	12



MG203R-MB206R, MB352R-MB355R, MB183R-MB188R



MB786R-MB789R, MB790R-MB794R

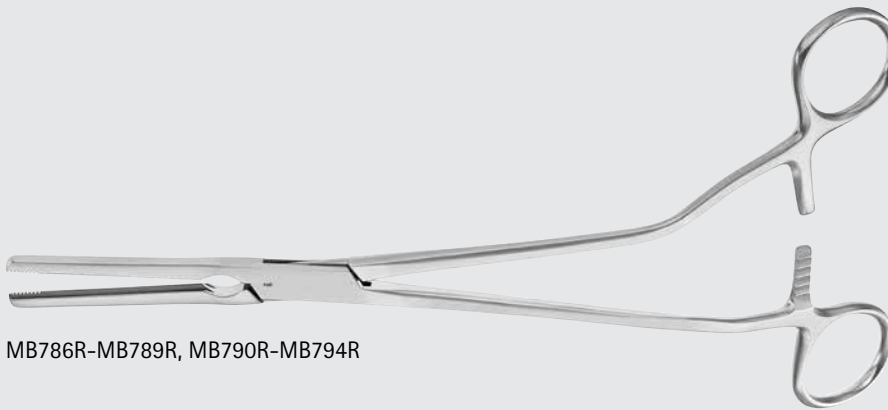

MG203R, MB352R, MB786R, MB187R, MB790R



MG204R, MB353R, MB787R, MB188R, MB792R



MG205R, MB354R, MB788R, MB183R, MB793R



MG206R, MB355R, MB789R, MB184R, MB794R

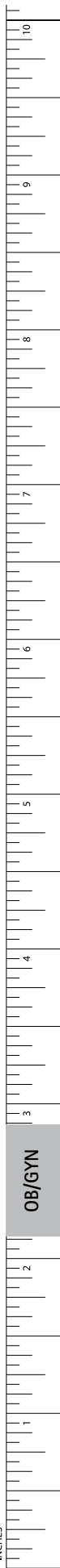

OB/GYN

INCHES

Obstetrics/Gynecology

Clamps

Z-Type Hysterectomy Clamp (continued)

Catalog Number	Jaw	Handle	Length (in.)
MB185R	STR	STR	14
MB186R	SLT-CVD	STR	14
MB987R	CVD	STR	14
MB988R	ANG	STR	14

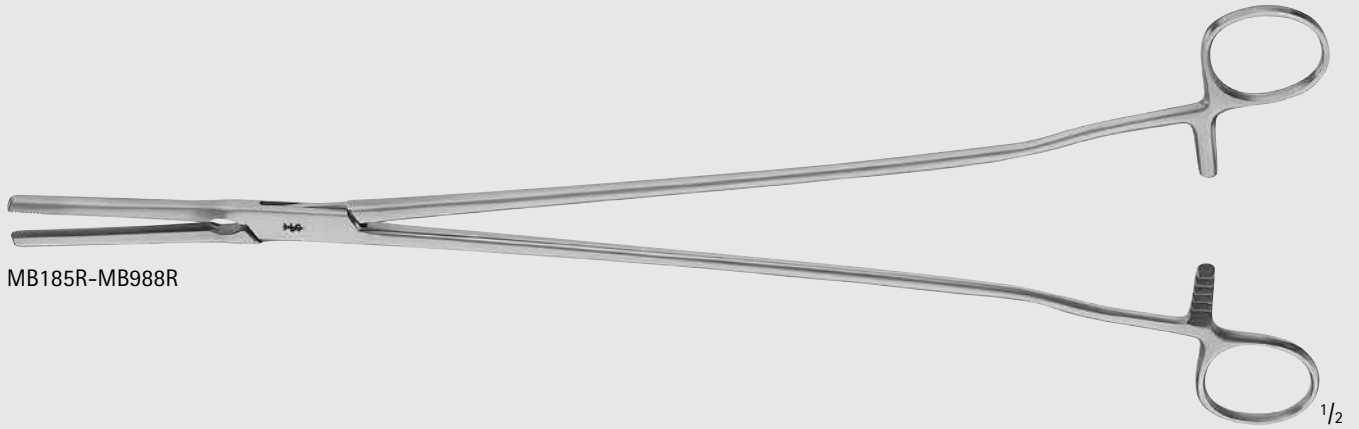

MB185R-MB988R



MB185R

1/1



MB186R

1/1



MB987R

1/1

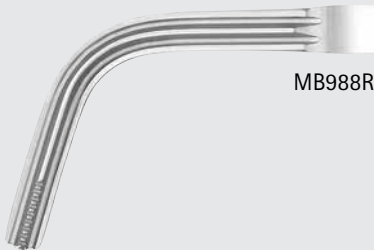

MB988R

1/1

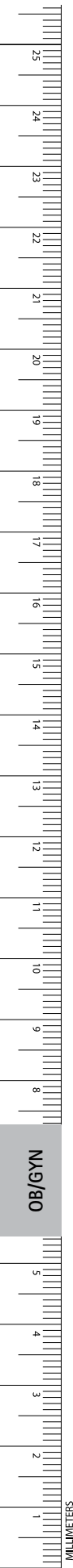

Obstetrics/Gynecology

Perineal and Vaginal Retractors

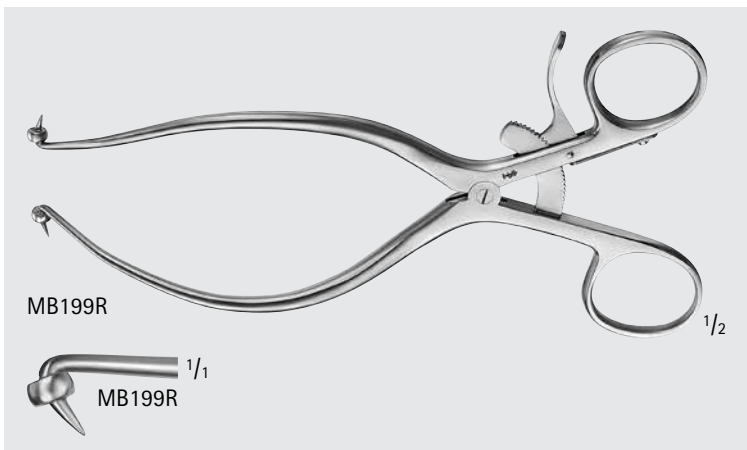

GELPI Perineal Retractor W/ Ball Stop

Catalog Number	Length (in.)
MB199R	7

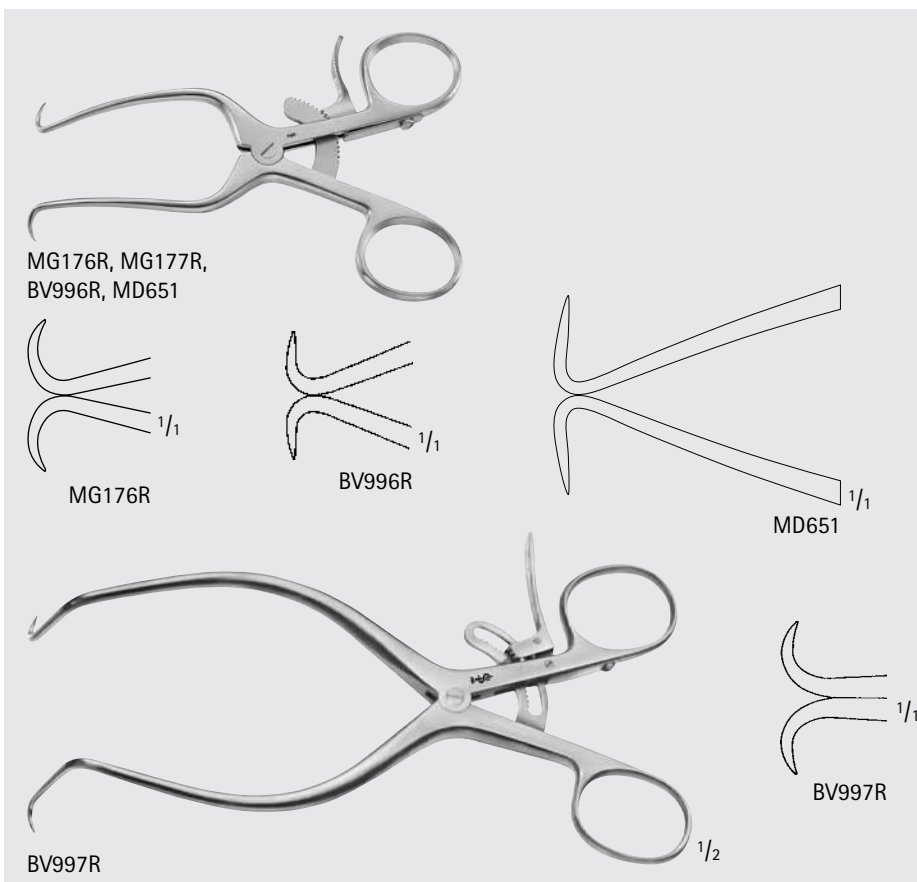

GELPI Vaginal Retractor

Catalog Number	Tip	Length (in.)
MG176R	SHARP	3 1/2
BV996R	SHARP	5 1/4
BV997R	SHARP	6 7/8
MD651	SHARP	7 1/4
MG177R	BLUNT	4 1/2



RIGBY Vaginal Retractor

Catalog Number	Length (in.)
MB267R	7 1/2

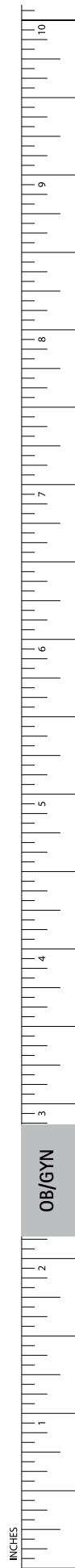

Obstetrics/Gynecology

Retractors

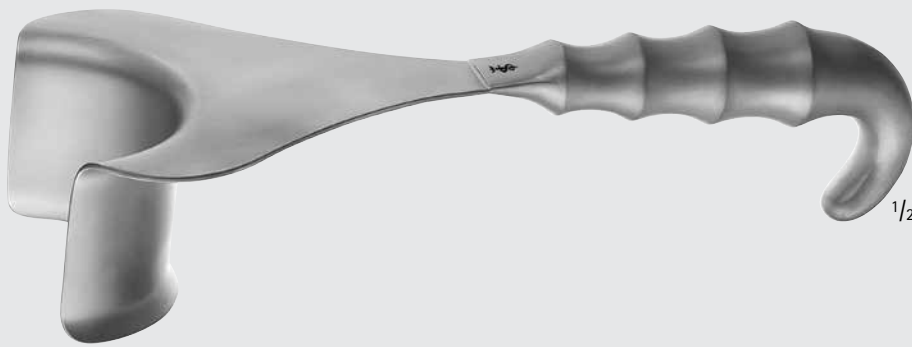

MB068R

DELEE Universal Retractor

Catalog Number	Length (in.)
MB068R	9 1/2



US100-US100202

O' SULLIVAN-O' CONNOR Retractor

Catalog Number	Description	Blade Size (mm)
US100	COMPLETE	185 x 143
US100201	SMALL BLADE	80 x 149
US100202	LARGE BLADE	155 x 110

US100 Includes:

- 1 Retractor US100200
- 2 Blades US100201 and
- 1 Blade US100202



US100201



US100202

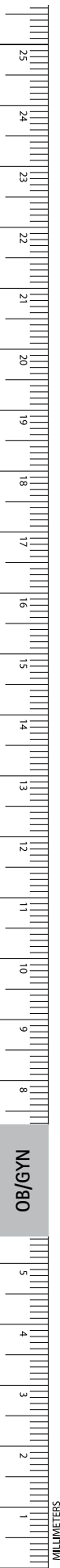

OB/GYN

MILLIMETERS

Obstetrics/Gynecology

Vaginal Retractors and Specula

COLLIN Vaginal Specula

Catalog Number	Blade Size (mm)
ELO11R	95/85 x 18



ELO11R

CUSCO Vaginal Specula

Catalog Number	Blade Size (mm)
ELO40R	75 x 17

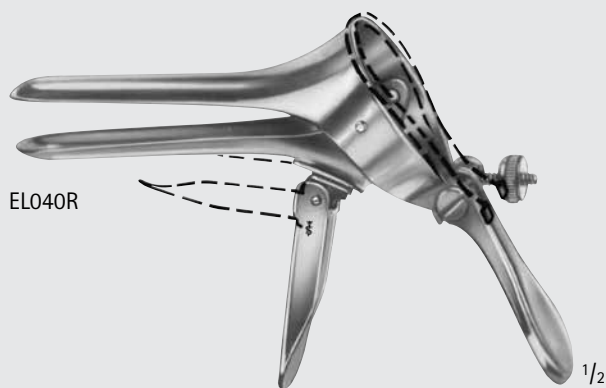

ELO40R

CUSCO Vaginal Specula

Catalog Number	Blade Size (mm)
ELO42R	80 x 32
ELO43R	90 x 36
ELO44R	110 x 37

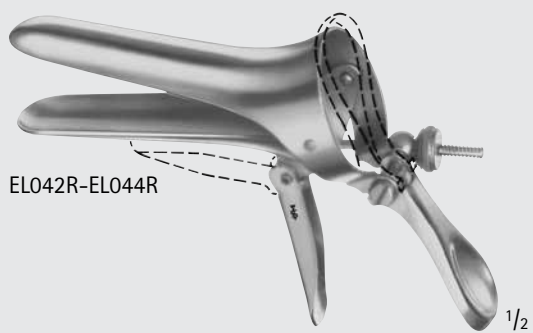

ELO42R-EL044R

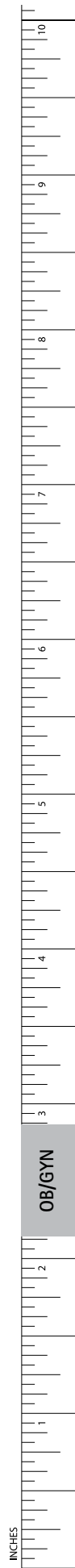

Obstetrics/Gynecology

Vaginal Retractors and Specula

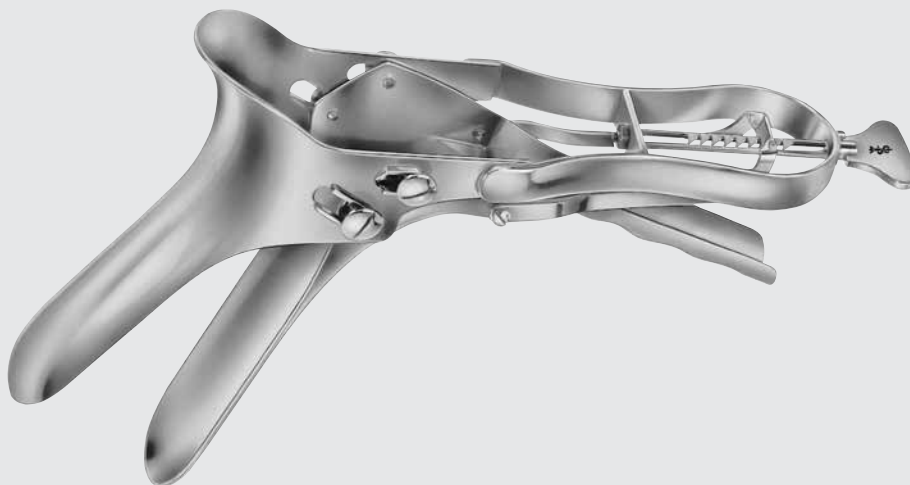

SEYFFERT Vaginal Specula

Catalog Number	Blade Size (mm)	Length (in.)
EL180R	100 x 17	9
EL181R	110 x 33	9

EL180R-EL181R

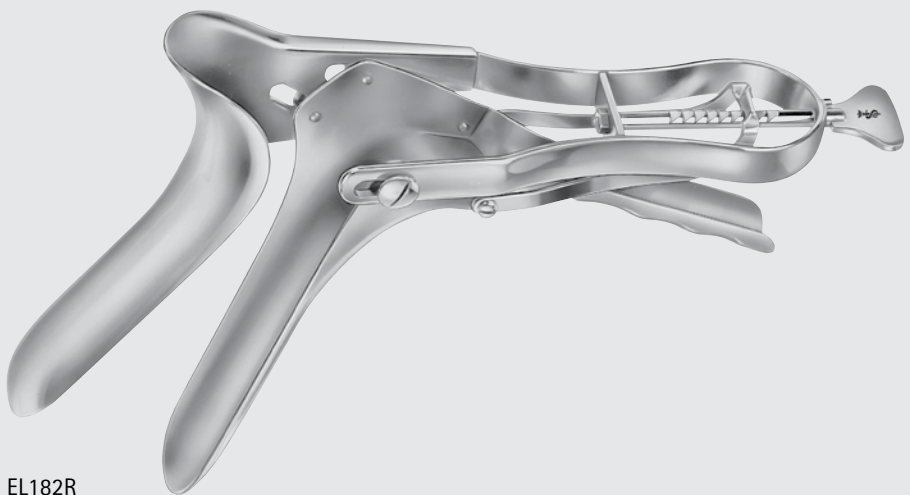

SEYFFERT Speculum, 1 Side Open

Catalog Number	Blade Size (mm)	Length (in.)
EL182R	110 x 33	9

EL182R



SEMM Vaginal Specula, 45° Angle

Catalog Number	Blade Size (mm)	Length (in.)
EL183R	90 x 14	7

EL183R

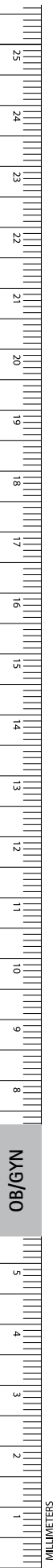

Obstetrics/Gynecology

Vaginal Retractors and Specula



MB066R-EL193R

PEDERSON Vaginal Speculum

Catalog Number	Blade Size (mm)
MB066R	75 x 12.7
EL192R	100 x 22
MG156R	115 x 16
EL193R	120 x 25



Obstetrics/Gynecology

Vaginal Retractors and Specula



MB067R

PEDERSON Vaginal Speculum, Large, Insulated Coating, W/ Evacuation Vent

Catalog Number	Blade Size (mm)
MB067R	120 x 25



EL194R-MG159R

GRAVES Vaginal Speculum

Catalog Number	Blade Size (mm)
EL194R	75 x 20
EL195R	95 x 30
EL196R	105 x 33
MG159R	125 x 40
MB841R	102 x 34 W/ SIDE OPENING



MB841R

OB/GYN

MILLIMETERS

Obstetrics/Gynecology

Vaginal Retractors and Specula

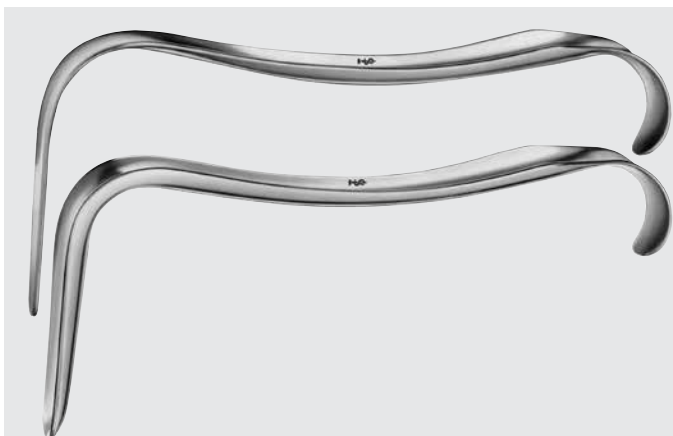

EL420R-EL428R

KRISTELLER Vaginal Speculum, Set of 2 each

Catalog Number	Blade Size (mm)	Length (in.)
EL420R	70 x 15	6 3/4
EL421R	70 x 27	6 7/8
EL422R	75 x 30	6 7/8
EL423R	90 x 36	6 7/8
EL426R	110 x 20	8 3/4
EL425R	110 x 27	8 3/4
EL427R	110 x 30	8 3/4
EL428R	110 x 36	8 3/4

Each blade size comes as a set of 2 - with one upper and one lower blade

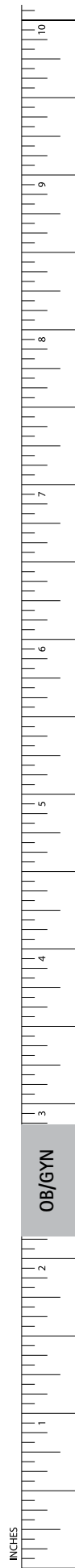

Obstetrics/Gynecology

Vaginal Retractors and Specula



EL450R-EL458R

KRISTELLER Vaginal Specula Upper Blades

Catalog Number	Blade Size (mm)	Length (in.)
EL450R	75 x 10	6 7/8
EL451R	75 x 23	7
EL452R	80 x 25	7
EL453R	100 x 32	7 1/4
EL454R	115 x 14	8 1/2
EL455R	115 x 23	8 1/2
EL457R	115 x 26	8 3/4
EL458R	120 x 30	8 7/8



EL450R



EL451R



EL452R



EL453R

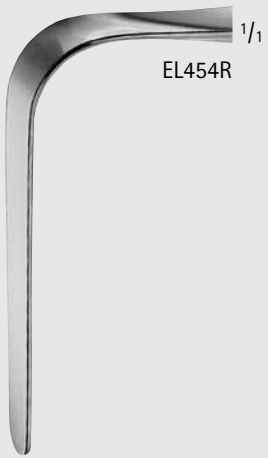

EL454R



EL455R



EL457R



EL458R



OB/GYN

MILLIMETERS

Obstetrics/Gynecology

Vaginal Retractors and Specula

KRISTELLER Vaginal Specula Lower Blades

Catalog Number	Blade Size (mm)	Length (in.)
EL440R	70 x 15	6 7/8
EL441R	70 x 27	7
EL442R	75 x 30	7
EL443R	90 x 36	7 1/4
EL444R	110 x 18	8 1/2
EL445R	110 x 27	8 1/2
EL446R	110 x 20	8 3/4
EL447R	110 x 30	8 3/4
EL448R	110 x 36	8 7/8



EL440R-EL448R



EL440R



EL441R



EL442R



EL443R



EL444R



EL445R



EL446R



EL447R



EL448R

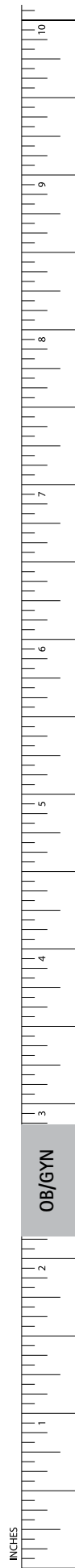

Obstetrics/Gynecology

Vaginal Retractors and Specula

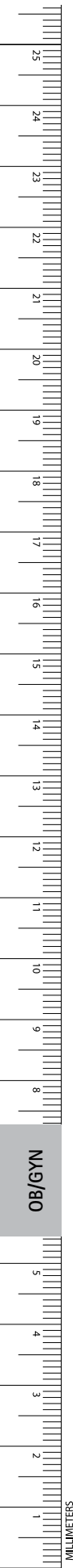

KALLMORGEN Vaginal Specula Set of 2

Catalog Number	Blade Size (mm)	Length (in.)
EL480R	75 x 39	6 3/4

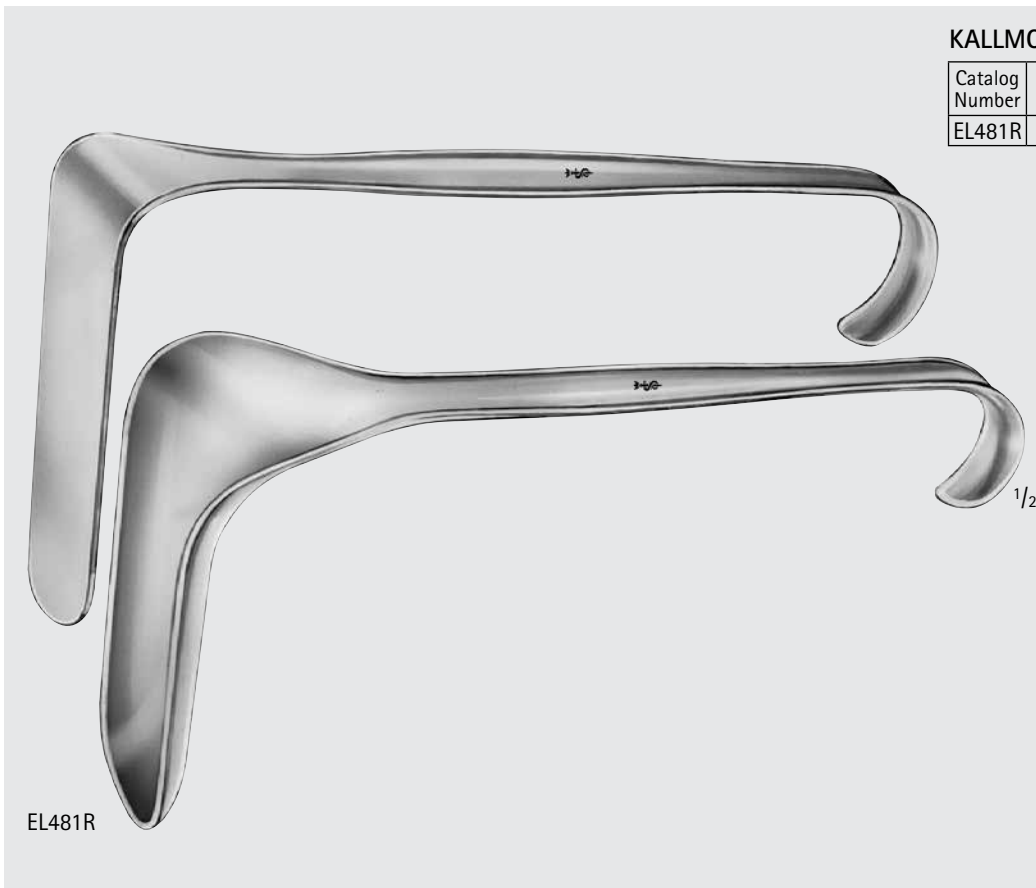

KALLMORGEN Vaginal Specula Set of 2

Catalog Number	Blade Size (mm)	Length (in.)
EL481R	95 x 39	7 7/8

Obstetrics/Gynecology

Vaginal Retractors and Specula



MB759R-MB761R

SIMS Vaginal Retractor

Catalog Number	Blade Size (mm)
MB759R	70 x 25
MB760R	76 x 32
MB761R	89 x 38



MG158R-EL409R

SIMS Vaginal Speculum, Double Ended

Catalog Number	Blade Size (mm)	Length (in.)
MG158R	69 x 25 / 70 x 30	5
EL407R	70 x 26 / 75 x 30	5
EL408R	75 x 30 / 80 x 35	6
EL409R	80 x 36 / 90 x 40	6 7/8

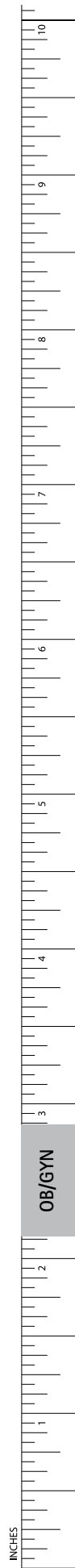

Obstetrics/Gynecology

Vaginal Retractors and Specula

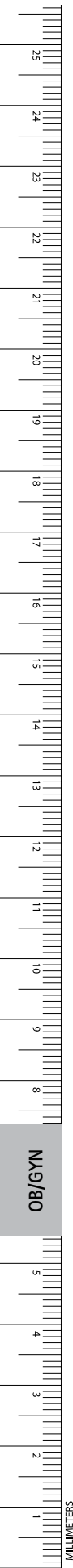

EL578R-EL579R

JACKSON Vaginal Speculum Lower Blade

Catalog Number	Blade	Blade Size (mm)	Length (in.)
EL578R	SLIGHT-CONCAVE	89 x 38	6 7/8
EL579R	SLIGHT-CONCAVE	102 x 38	6 7/8



EL578R



EL579R



EL581R, MB764R-MB765R

EASTMAN Vaginal Retractor

Catalog Number	Blade Size (mm)	Length (in.)
MB764R	75 x 40	6 7/8
EL581R	89 x 38	6 7/8
MB765R	100 x 40	6 7/8

Obstetrics/Gynecology

Vaginal Retractors and Specula

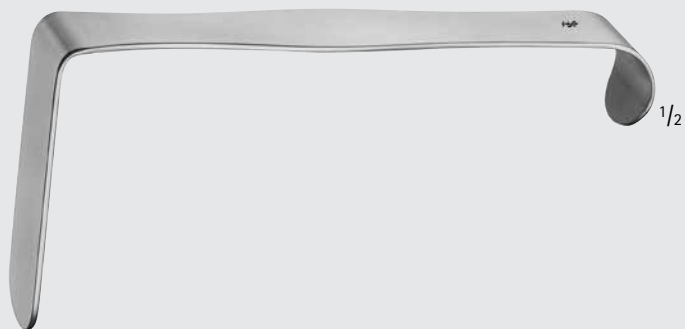

EL865R



MB762R-MB763R

HEANEY Retractor

Catalog Number	Blade Size (mm)	Length (in.)
MB762R	45 x 25	6 3/4
MB763R	73 x 29	6 3/4
EL865R	83 x 29	6 3/4

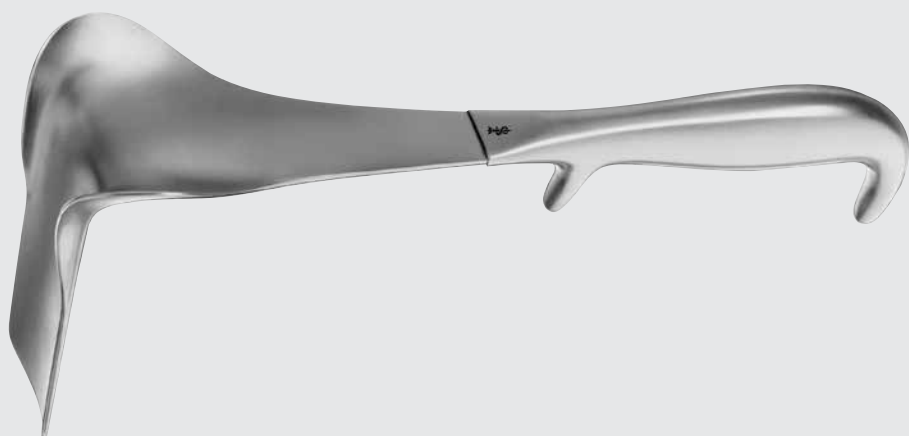

EL627R-EL629R

DOYEN Vaginal Speculum

Catalog Number	Blade Size (mm)	Length (in.)
EL627R	60 x 45	9 1/4
EL628R	90 x 45	9 1/4
EL629R	112 x 45	9 1/4

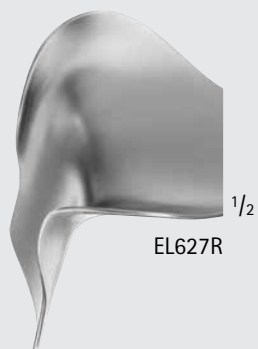

EL627R



EL628R



EL629R

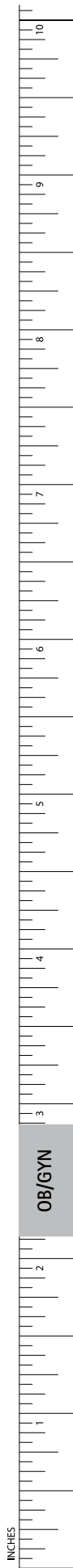

Obstetrics/Gynecology

Vaginal Retractors and Specula

DOYEN Vaginal Speculum

Catalog Number	Blade Size (mm)	Length (in.)
EL631R	60 x 35	9 1/2
EL632R	90 x 35	9 1/2
EL633R	120 x 35	9 1/2
EL634R	60 x 45	9 1/2
EL635R	90 x 45	9 1/2
EL636R	120 x 45	9 1/2
EL637R	60 x 60	9 1/2
EL638R	90 x 60	9 1/2
EL639R	120 x 60	9 1/2
EL642R	160 x 45	9 1/2
EL644R	160 x 60	9 1/2

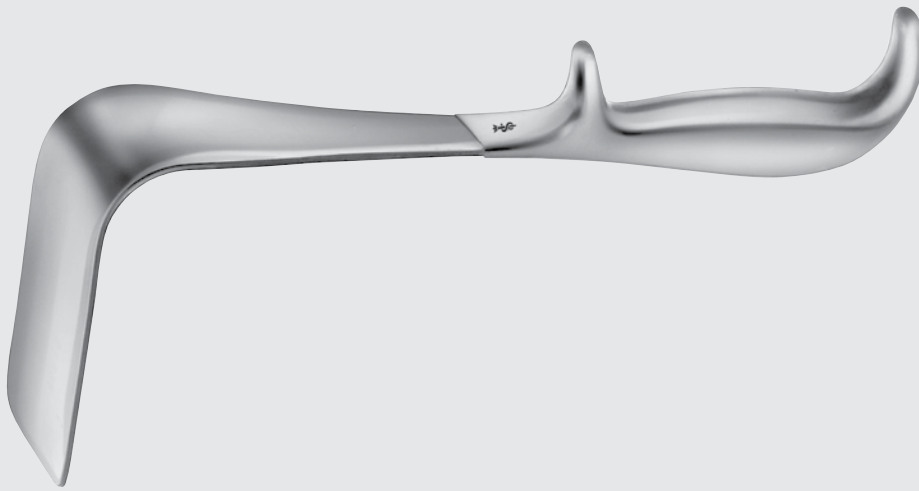

EL631R-EL644R

BREISKY Vaginal Speculum

Catalog Number	Blade Size (mm)	Length (in.)
EL703R	100 x 20	11 3/4
EL704R	100 x 25	11 3/4
EL705R	100 x 30	11 3/4
EL707R	100 x 35	11 3/4
EL708R	100 x 40	11 3/4
EL693R	130 x 20	12 1/2
EL694R	130 x 25	12 1/2
EL695R	130 x 30	12 1/2
EL697R	130 x 35	12 1/2
EL698R	130 x 40	12 1/2
EL700R	160 x 40	13 3/4
EL702R	180 x 40	13 3/4



EL700R-EL708R, EL693R-EL698R



OB/GYN

Obstetrics/Gynecology

Vaginal Retractors and Specula

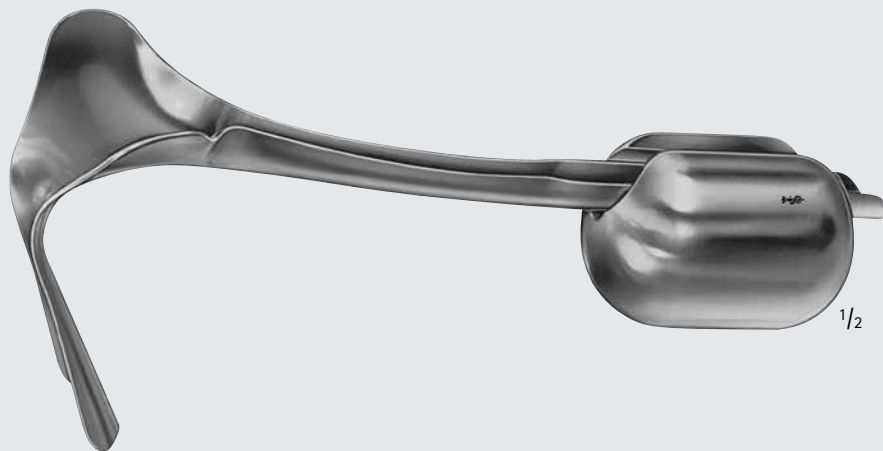

EL736R

AUVARD Speculum, W/ Detachable Weight

Catalog Number	Blade Size (mm)	Length (in.)
EL736R	65 x 38-28	9

Weight:
Speculum, only: 0.3 lbs.
Weight, only: 1.7 lbs.

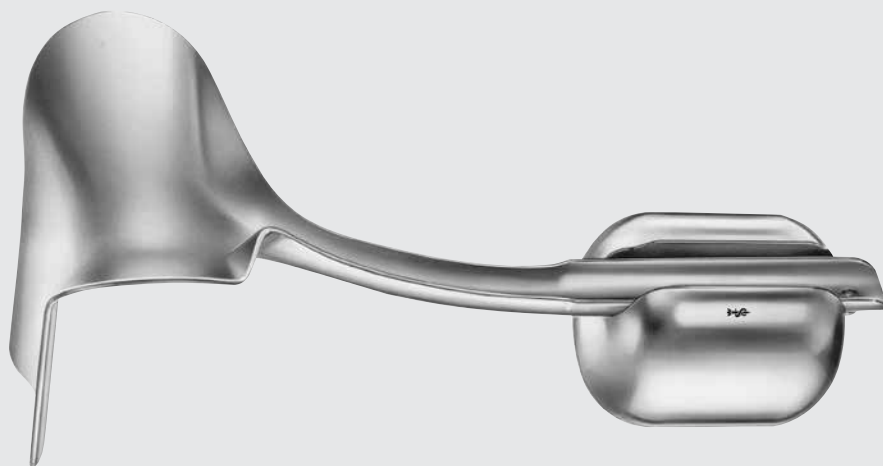

EL738R-EL739R

AUVARD Speculum, W/ Detachable Weight

Catalog Number	Blade Size (mm)	Length (in.)
EL738R	75 x 42-40	9
EL739R	105 x 43-40	9

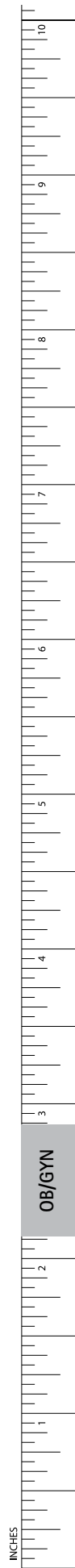

OB/GYN

Obstetrics/Gynecology

Vaginal Retractors and Specula

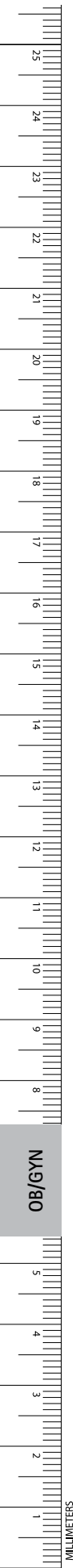

MG157R-MD411

AUVARD Speculum

Catalog Number	Blade Size (mm)	Length (in.)
MG157R	48 x 70	9 1/2
MD410	85 x 38	9 3/4
MD411	102 x 38	9 3/4

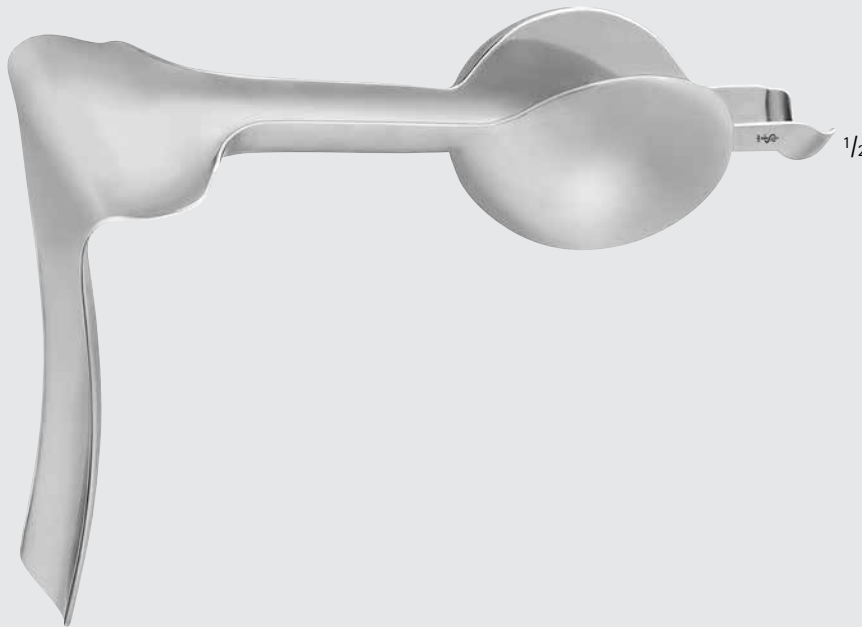

MB935R

STEINER-AUVARD Vaginal Speculum, Malleable, Goose Neck

Catalog Number	Blade Size (mm)
MB935R	140 x 30

Obstetrics/Gynecology

Vaginal Retractors and Specula

DOYEN Lateral Speculum

Catalog Number	Blade Size (mm)	Length (in.)
EL859R	60 x 30	9
EL860R	80 x 30	9 3/4



EL859R-EL860R

SCHERBACK Vaginal Speculum Set

Catalog Number	Description	Blade Size (mm)
EL740R	SET COMPLETE	-
EL741R	BLADE	80 x 30
EL742R	BLADE	85 x 35
EL743R	BLADE	85 x 40
EL744R	BLADE	55 x 40
EL745R	BLADE	70 x 45
EL746R	HANDLE	-
EL747R	WEIGHT	-

EL740R Includes:
 1 Handle EL746R
 1 Weight EL747R
 4 Blades of each
 EL741R-EL744R

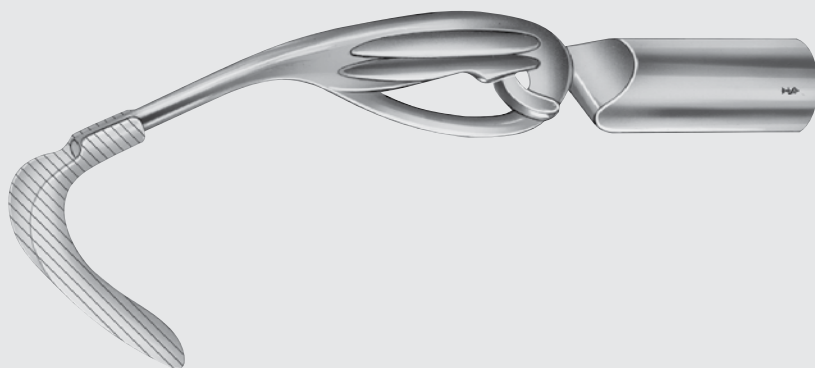

EL740R-EL747R



EL741R



EL742R



EL743R

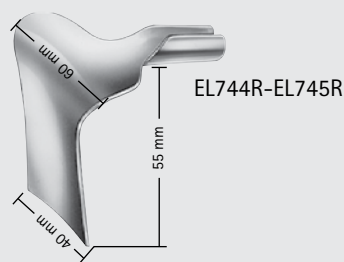

EL744R-EL745R

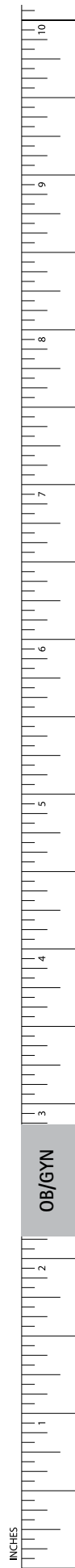

INCHES

OB/GYN

Obstetrics/Gynecology

Vaginal Retractors and Specula

TUEBINGER Vaginal Retractor

Catalog Number	Blade Size (mm)	Length (in.)
EL868R	95 x 20	10 1/2

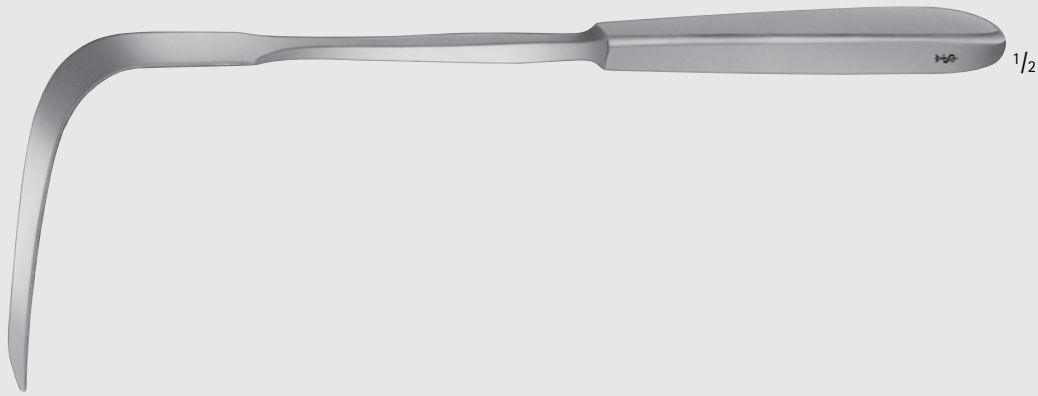

EL868R

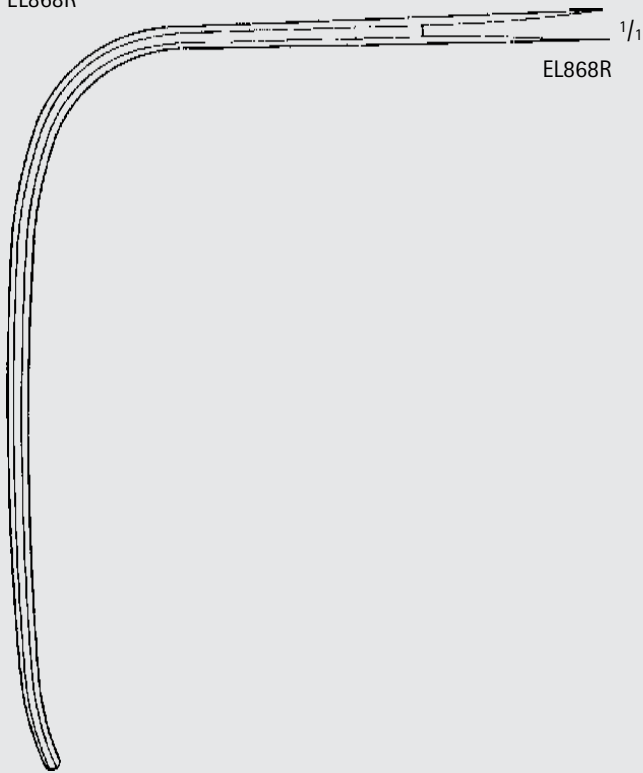

EL868R

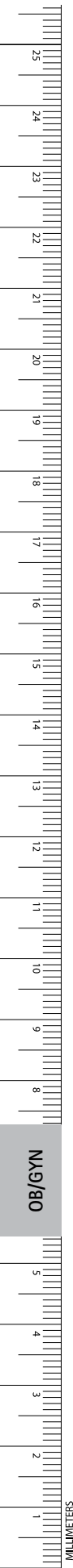

Obstetrics/Gynecology
Vaginal Retractors and Specula

GLENNER Retractor

Catalog Number	Blade Size (mm)	Length (in.)
MG175R	135 x 25	10 5/8



MG175R

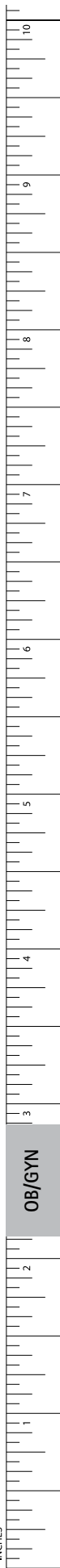

Obstetrics/Gynecology

Vaginal Retractors and Specula

MARTIN Vaginal Retractor

Catalog Number	Blade Size (mm)	Length (in.)
EL870R	105 x 27	9 3/4

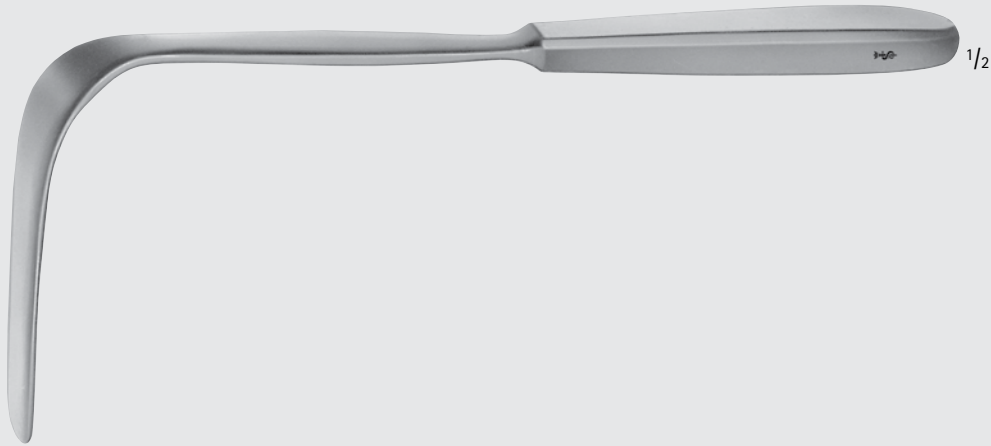

EL870R

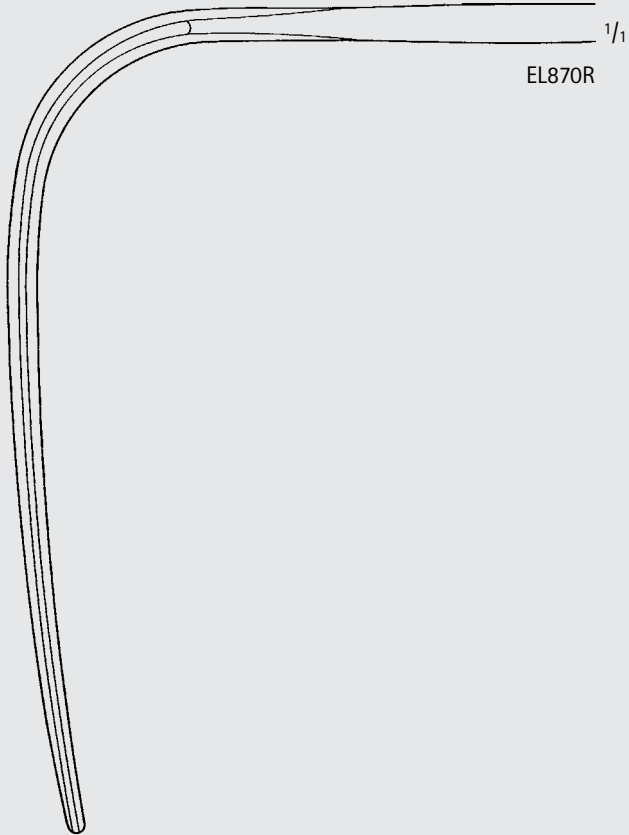

EL870R

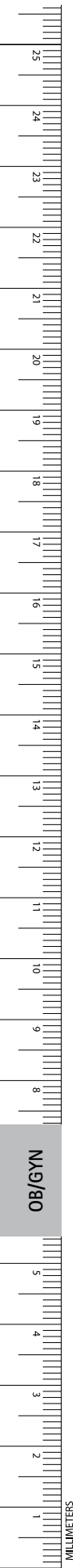

Obstetrics/Gynecology

Vaginal Retractors and Specula

SIMON Vaginal Retractor

Catalog Number	Blade Size (mm)	Length (in.)
EL872R	115 x 22	10 3/4
EL873R	115 x 27	10 3/4

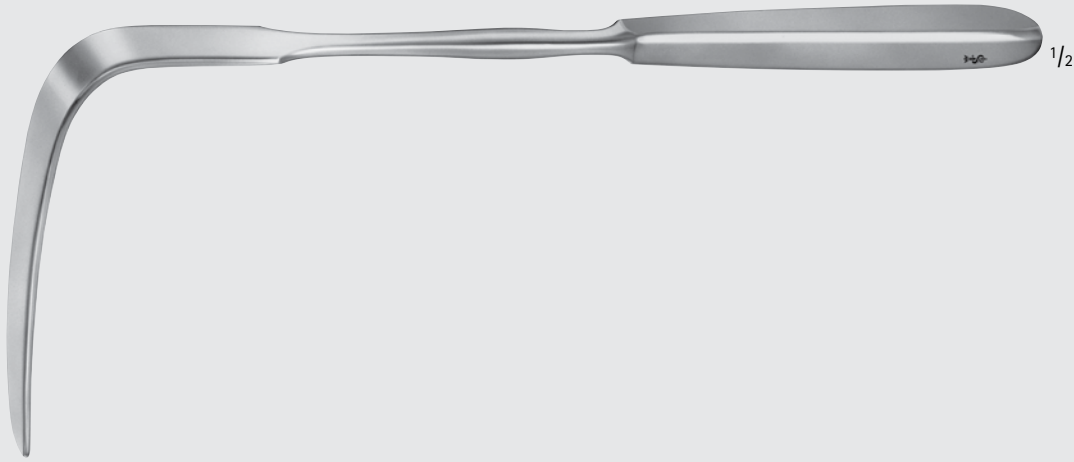

EL872R-EL872R

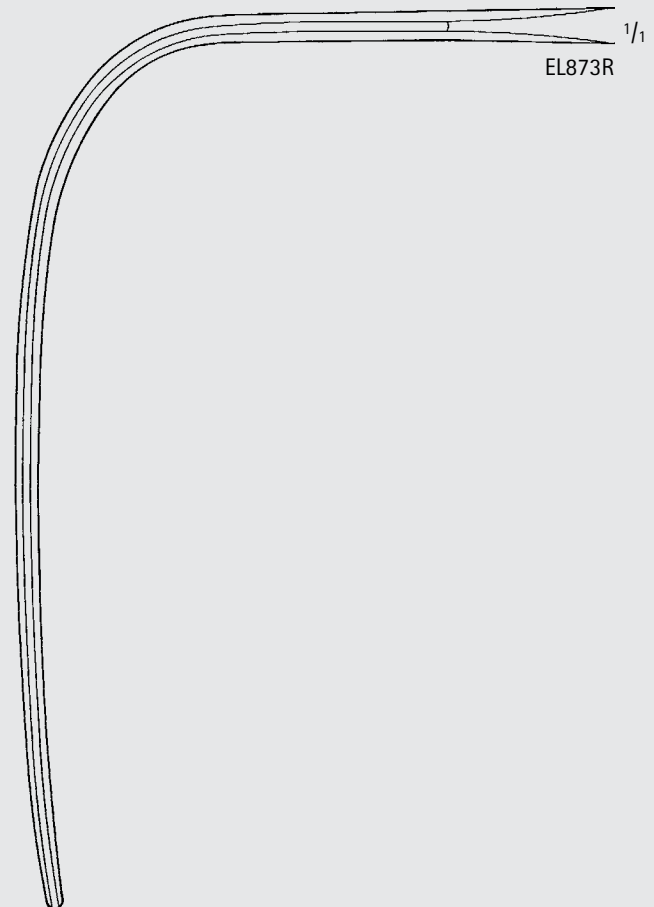
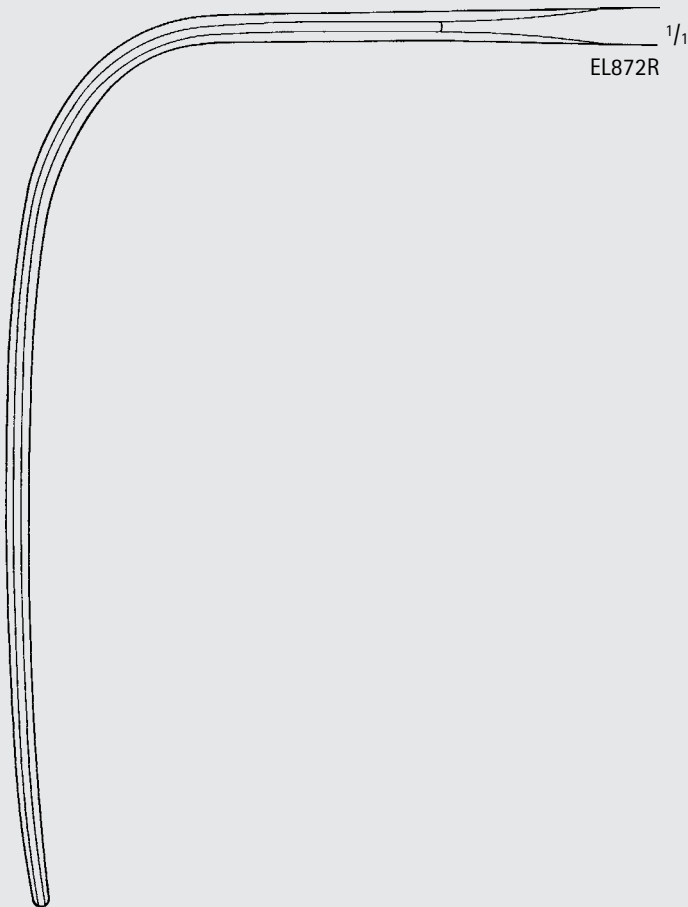

Obstetrics/Gynecology

Endospecula

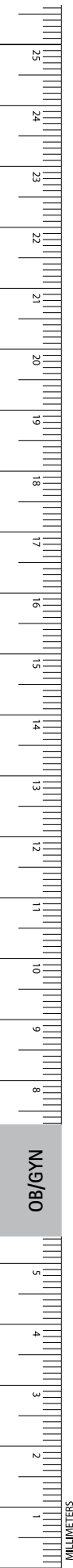

KOGAN Endospeculum

Catalog Number	Length (in.)
EM710R	9 1/2

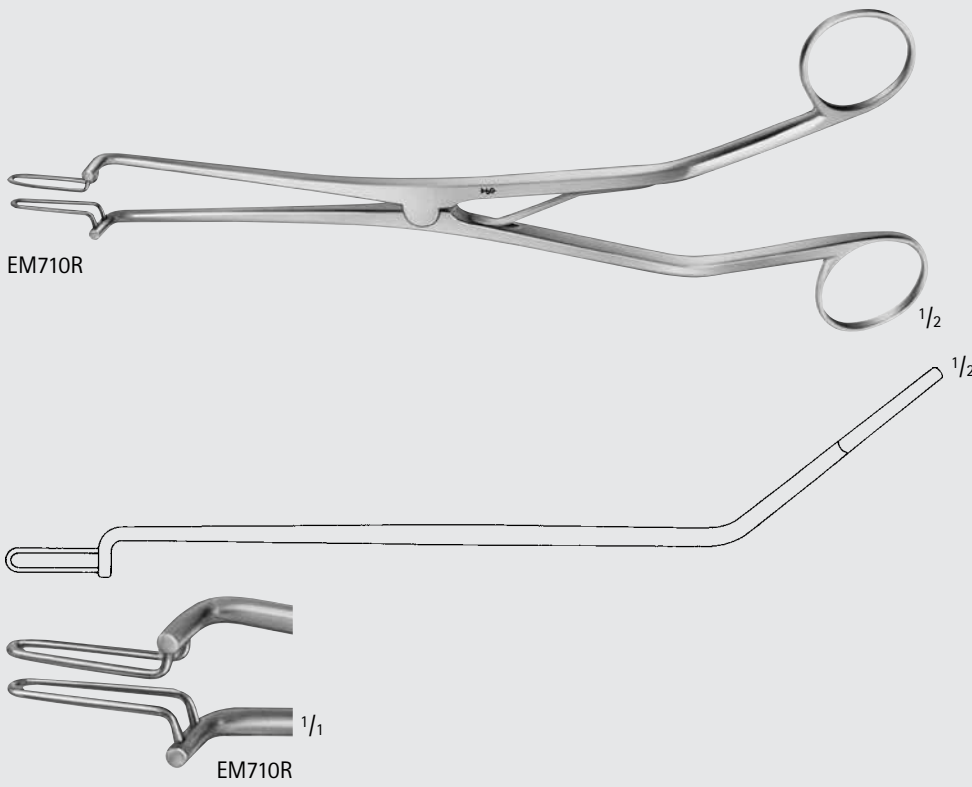

KOGAN Cervix/Urethra Endospeculum, W/ Scale, Ratcheted

Catalog Number	Length (in.)
EM711R	9 1/2

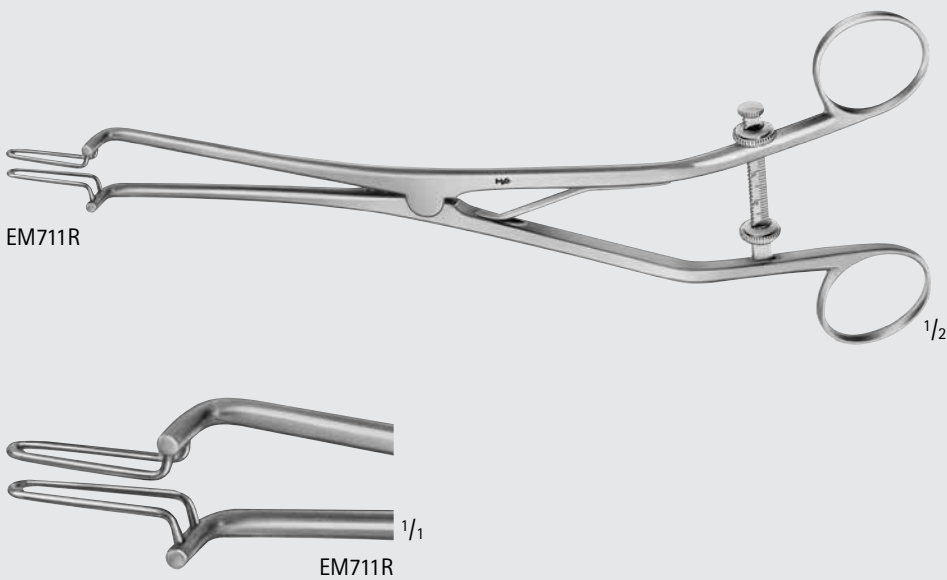



EM101R-EM147R

HEGAR Dilator, Single Ended

Catalog Number	Tip Size (mm)	Length (in.)
EM101R	1	7 1/4
EM102R	2	7 1/4
EM103R	3	7 1/4
EM104R	4	7 1/4
EM105R	5	7 1/4
EM106R	6	7 1/4
EM107R	7	7 1/4
EM108R	8	7 1/4
EM109R	9	7 1/4
EM110R	10	7 1/4
EM111R	11	7 1/4
EM112R	12	7 1/4
EM113R	13	7 1/4
EM114R	14	7 1/4
EM115R	15	7 1/4
EM116R	16	7 1/4
EM117R	17	7 1/4
EM118R	18	7 1/4
EM119R	19	7 1/4
EM120R	20	7 1/4
EM121R	21	7 1/4
EM122R	22	7 1/4
EM123R	23	7 1/4
EM124R	24	7 1/4
EM125R	25	7 1/4
EM126R	26	7 1/4
EM131R	1.5	7 1/4
EM132R	2.5	7 1/4
EM133R	3.5	7 1/4
EM134R	4.5	7 1/4
EM135R	5.5	7 1/4
EM136R	6.5	7 1/4
EM137R	7.5	7 1/4
EM138R	8.5	7 1/4
EM139R	9.5	7 1/4
EM140R	10.5	7 1/4
EM141R	11.5	7 1/4
EM142R	12.5	7 1/4
EM143R	13.5	7 1/4
EM144R	14.5	7 1/4
EM145R	15.5	7 1/4
EM146R	16.5	7 1/4
EM147R	17.5	7 1/4



Obstetrics/Gynecology

Dilators and Probes



EM193R-EM194R

HEGAR Dilator Set, Single Ended

Catalog Number	Item
EM193R	SET W/ 14 DILATORS, 4-17 mm
EM194R	SET W/ 26 DILATORS, 1-26 mm

EM193R Includes:
 EM097R Rack for Dilators 4-12 mm
 EM098R Rack for Dilators 13-17 mm
 JG161R Metal Case: 200 x 100 x 35 mm

Includes Dilators:
 EM104R-EM117R

EM194R Includes:
 EM099R Rack for Dilators 1-17 mm
 EM100R Rack for Dilators 18-26 mm
 JG170R Metal Case: 330 x 220 x 80 mm

Includes Dilators:
 EM101R-EM126R



EM231R-EM244R

HEGAR Uterine Dilator, Double Ended

Catalog Number	Tip Size (mm)	Length (in.)
EM244R	SET OF 8	-
EM231R	1/2	7 3/4
EM232R	3/4	7 3/4
EM233R	5/6	7 3/4
EM234R	7/8	7 3/4
EM235R	9/10	7 3/4
EM236R	11/12	7 3/4
EM237R	13/14	7 3/4
EM238R	15/16	7 3/4
EM239R	17/18	7 3/4

Set Includes:
 EM232R-EM239R

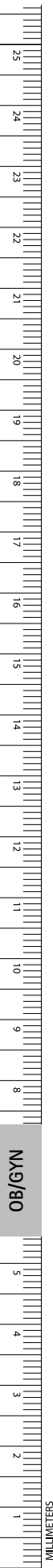

HEGAR Uterine Dilator, Slight Curved, Double Ended

Catalog Number	Tip Size (mm)	Length (in.)
MG270R	SET OF 8	-
MG251R	1/2	8
MG252R	3/4	8
MG253R	5/6	8
MG254R	7/8	8
MG255R	9/10	8
MG256R	11/12	8
MG257R	13/14	8
MG258R	15/16	8
MG259R	17/18	8

MG270R Set of 8 includes MG252R-MG259R



MG270R-MG259R

PRATT Uterine Dilator

Catalog Number	Tip Size (FR)	Length (in.)
EM270R	COMPLETE SET	-
EM271R	13/15	11 1/2
EM272R	17/19	11 1/2
EM273R	21/23	11 1/2
EM274R	25/27	11 1/2
EM275R	29/31	11 1/2
EM276R	33/35	11 1/2
EM277R	37/39	11 1/2
EM278R	41/43	11 1/2

EM270R Set of 8 includes EM271R-EM278R



EM270R-EM278R

HANK Dilator, French Scale

Catalog Number	Tip Size (FR)	Length (in.)
MD593R	COMPLETE SET	10
MD579R	9/10	10
MD594	11/12	10
MD595	13/14	10
MD596	15/16	10
MD597	17/18	10
MD598	19/20	10

MD593R Set of 6 includes MD579R, MD594-MD598



MD593R-MD598

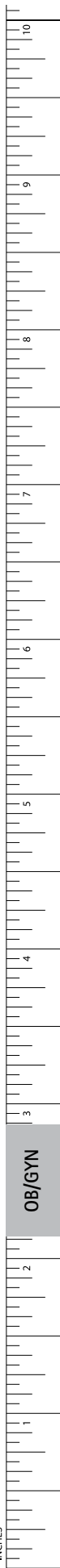

Obstetrics/Gynecology

Dilators and Probes

HANK Dilator, American Scale

Catalog Number	Tip Size (mm)	Length (in.)
MD070R	COMPLETE SET	-
MD064R	9/10	10 3/4
MD065R	11/12	10 3/4
MD066R	13/14	10 3/4
MD067R	15/16	10 3/4
MD068R	17/18	10 3/4
MD069R	19/20	10 3/4

MD070R Set of 6 includes MD064R-MD069R



MD070R-MD069R

SIMS Uterine Probe, Graduated (cm)

Catalog Number	Tip	Tip Size (mm)	Blade	Length (in.)
EO010R	RGD	4	CVD	13
EO012R	MALL	4	CVD	13

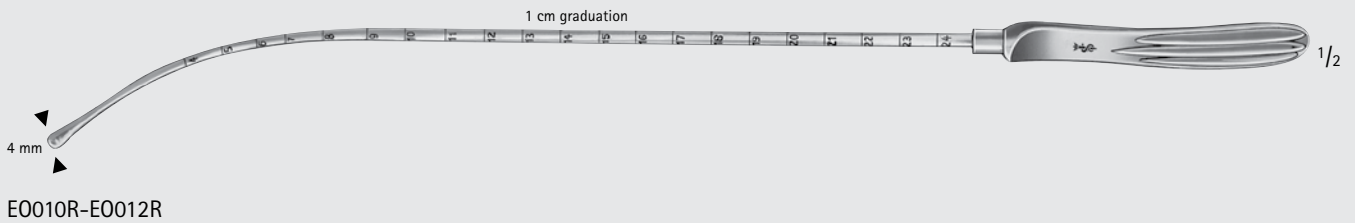

EO010R-EO012R

MARTIN Uterine Probe, Graduated (cm)

Catalog Number	Blade	Length (in.)
EO015R	CVD	11 3/4

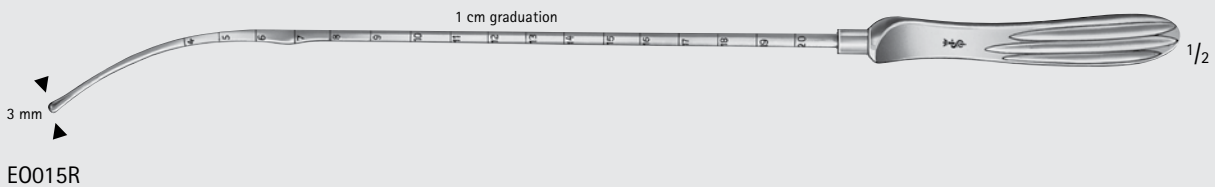

EO015R

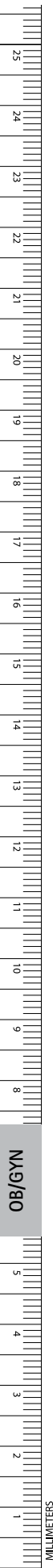

OB/GYN

**VALLEIX Uterine Probe,
Graduated (cm), W/ Slider**

Catalog Number	Tip Size (mm)	Blade	Length (in.)
E0016R	4	CVD	9 3/4

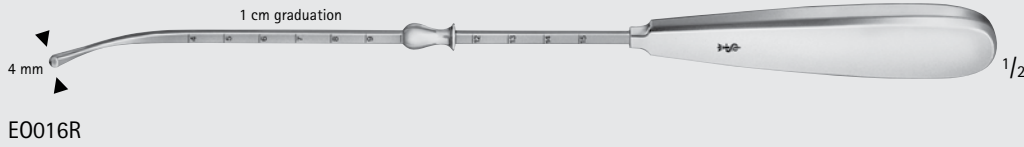

**SIMPSON Uterine Probe,
Graduated (cm)**

Catalog Number	Tip	Tip Size (mm)	Blade	Length (in.)
E0020	MALL	4	CVD	12 1/4

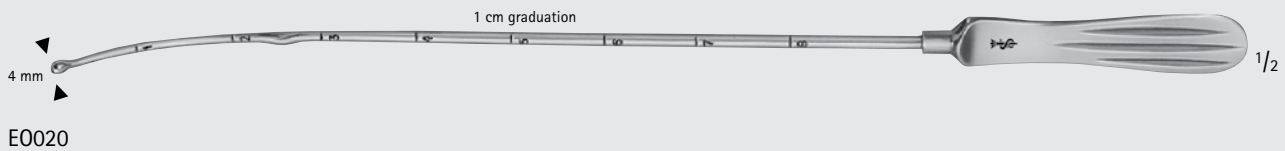

**BRAUN Uterine Depressor, Double
Ended**

Catalog Number	Blade Size (mm)	Length (in.)
E0030R	24/28	10 5/8



Obstetrics/Gynecology

Curettes



ASCH Uterine Secretion Scoop, Malleable, Double Ended

Catalog Number	Length (in.)
ER005R	7 7/8

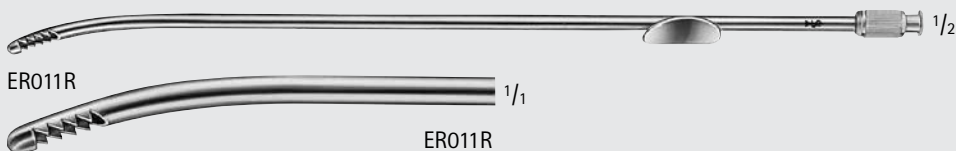

NOVAK Endometrial Biopsy Suction Curette

Catalog Number	Length (in.)
ER011R	9 1/2

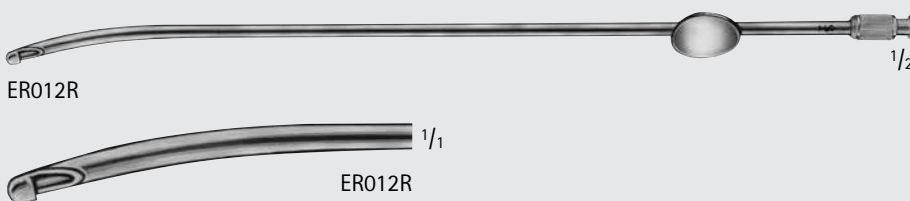

RANDALL Endometrial Suction and Biopsy Curette

Catalog Number	Length (in.)
ER012R	9 1/2

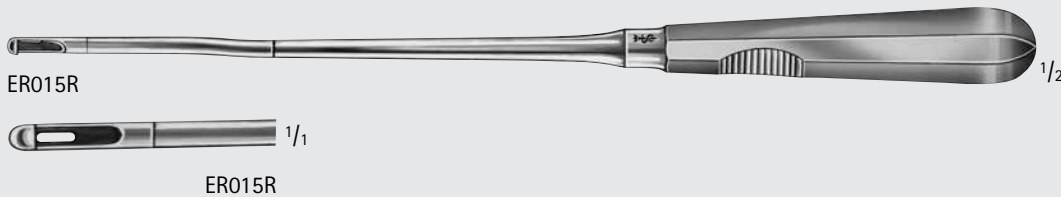

BERLIN Endometrial Biopsy Curette

Catalog Number	Tip Size (mm)	Length (in.)
ER015R	3.5	10 5/8

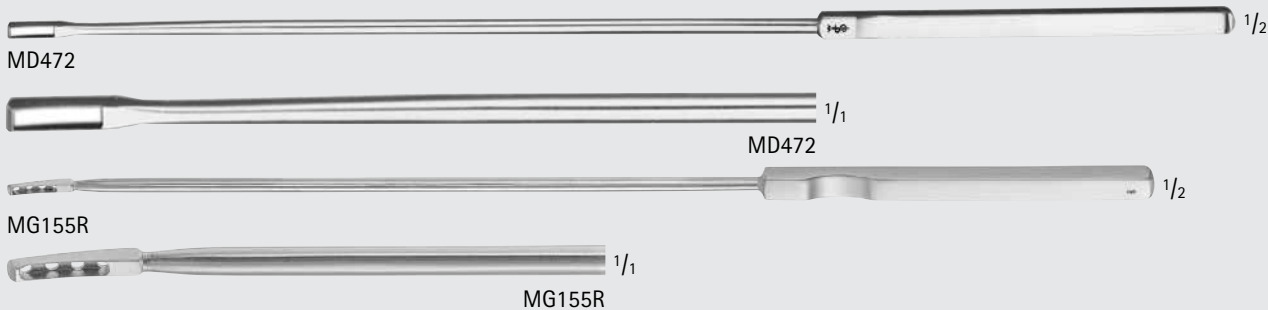

KEVORKIAN-YOUNGE Biopsy Curette

Catalog Number	Tip	Description	Length (in.)
MD472	SLIGHT-CVD	W/O Basket	13
MG155R	SLIGHT-CVD	W/ Basket	12 1/4

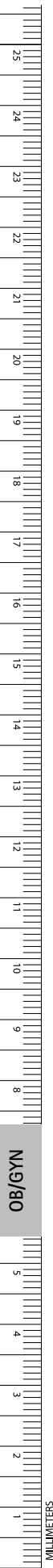

RECAMIER Uterine Curette

Catalog Number	Tip Size (#)	Tip Size (mm)	Tip	Length (in.)
ER219R	00	4.5	SHARP	11 3/4
ER220R	0	7.5	SHARP	11 3/4
ER221R	1	8.5	SHARP	11 3/4
ER222R	2	10.5	SHARP	11 3/4
ER223R	3	12.0	SHARP	11 3/4
ER224R	4	14.0	SHARP	11 3/4
ER225R	5	15.0	SHARP	11 3/4
ER226R	6	16.5	SHARP	11 3/4
ER227R	7	18.0	SHARP	11 3/4
ER228R	8	19.5	SHARP	11 3/4
ER229R	9	21.5	SHARP	11 3/4
ER230R	10	23.5	SHARP	11 3/4
ER241R	1	8.5	SHARP/MALL	11 3/4
ER242R	2	10.5	SHARP/MALL	11 3/4
ER243R	3	12.0	SHARP/MALL	11 3/4
ER244R	4	14.0	SHARP/MALL	11 3/4
ER245R	5	15.0	SHARP/MALL	11 3/4
ER246R	6	16.5	SHARP/MALL	11 3/4
ER247R	7	18.0	SHARP/MALL	11 3/4
ER248R	8	19.5	SHARP/MALL	11 3/4
ER320R	0	7.5	BLUNT	11 3/4
ER321R	1	8.5	BLUNT	11 3/4
ER322R	2	10.5	BLUNT	11 3/4
ER323R	3	12.0	BLUNT	11 3/4
ER324R	4	14.0	BLUNT	11 3/4
ER325R	5	15.0	BLUNT	11 3/4
ER326R	6	16.5	BLUNT	11 3/4
ER327R	7	18.0	BLUNT	11 3/4
ER328R	8	19.5	BLUNT	11 3/4
ER329R	9	21.5	BLUNT	11 3/4
ER330R	10	23.5	BLUNT	11 3/4
ER611R	1	34.5	BLUNT	14 1/4
ER612R	2	39.5	BLUNT	14 1/4



ER219R-ER330R

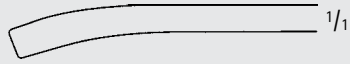

Fig. 00
1/1

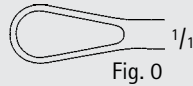
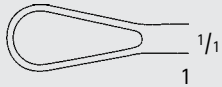
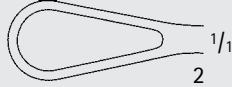

Fig. 0
1/1



1
1/1



2
1/1

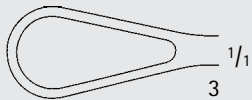

3
1/1



4
1/1



5
1/1



6
1/1

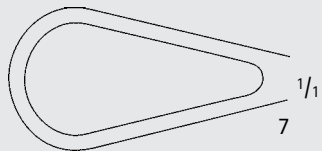

7
1/1

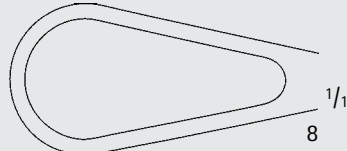

8
1/1

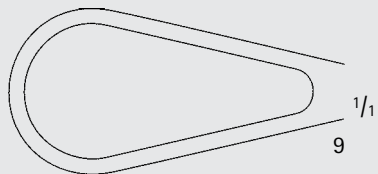

9
1/1

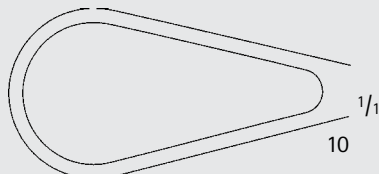

10
1/1



ER611R-ER612R

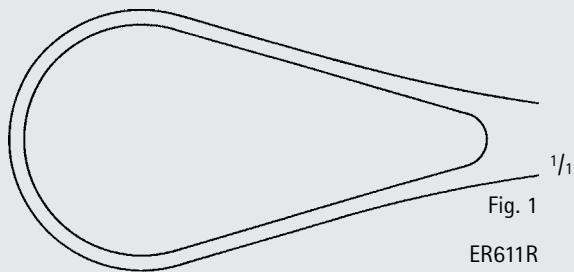

Fig. 1
ER611R

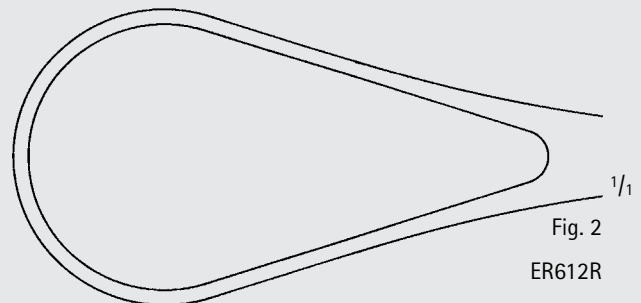

Fig. 2
ER612R



Obstetrics/Gynecology

Curettes

SIMS Uterine Curette

Catalog Number	Tip Size (#)	Tip Size (mm)	Tip	Length (in.)
ER401R	1	7.5	SHARP	10
ER402R	2	8.5	SHARP	10
ER403R	3	10.5	SHARP	10
ER404R	4	12.0	SHARP	10
ER405R	5	14.0	SHARP	10
ER406R	6	15.0	SHARP	10
ER411R	1	7.5	SHARP/MALL	10
ER412R	2	8.5	SHARP/MALL	10
ER413R	3	10.5	SHARP/MALL	10
ER414R	4	12.0	SHARP/MALL	10
ER415R	5	14.0	SHARP/MALL	10
ER416R	6	15.0	SHARP/MALL	10
ER421R	1	7.5	BLUNT	10
ER422R	2	8.5	BLUNT	10
ER423R	3	10.5	BLUNT	10
ER424R	4	12.0	BLUNT	10
ER425R	5	14.0	BLUNT	10
ER426R	6	15.0	BLUNT	10
MG140R	000	4.5	SHARP/MALL	11
MG141R	00	5.6	SHARP/MALL	11
MG142R	0	6.2	SHARP/MALL	11
MG143R	1	7.3	SHARP/MALL	11
MG144R	2	8.5	SHARP/MALL	11
MG145R	3	9.4	SHARP/MALL	11
MG146R	4	10.6	SHARP/MALL	11
MG147R	5	11.5	SHARP/MALL	11
MG148R	6	12.6	SHARP/MALL	11



ER401R-MG148R

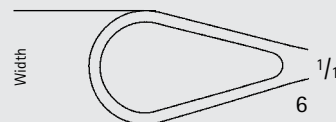
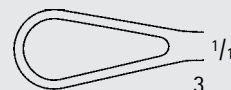
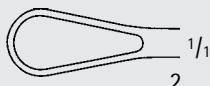
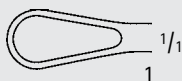
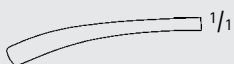

ER401R-ER426R

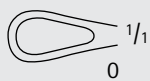
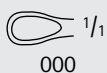

MG140R-MG148R

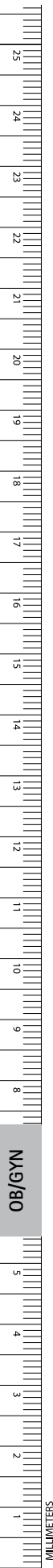

**BUMM Uterine Curette, Blunt
Malleable**

Catalog Number	Tip Size (#)	Tip Size (mm)	Length (in.)
ER520R	0	16.0	11 1/2
ER521R	1	18.0	11 1/2
ER522R	2	19.5	11 1/2
ER523R	3	21.5	11 1/2
ER524R	4	23.5	11 1/2
ER525R	5	26.0	11 1/2
ER526R	6	28.5	11 1/2



ER520R-ER526R

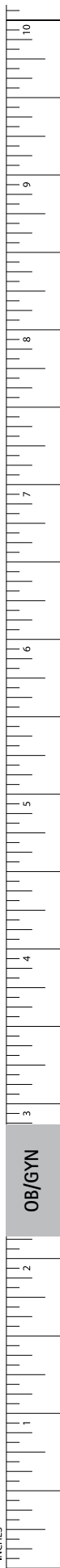
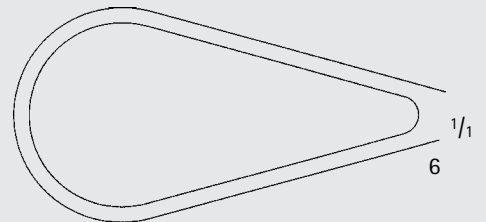
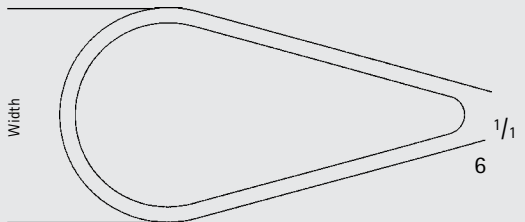
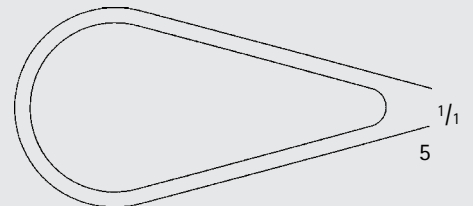
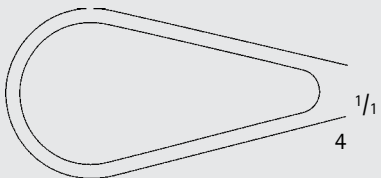
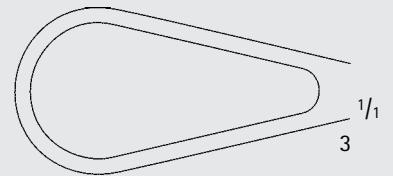
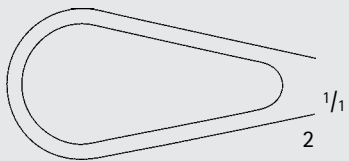
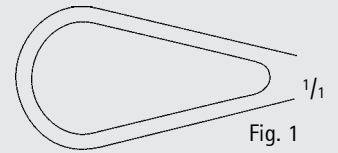
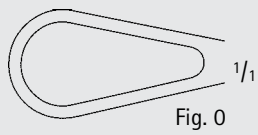

Obstetrics/Gynecology

Curettes

SIMS THOMAS Uterine Curette, Blunt/Malleable

Catalog Number	Tip Size (#)	Tip Size (mm)	Length (in.)
MG149R	0	6.0	11
ER211R	1	8.5	11
ER212R	2	10.5	11
ER213R	3	12.0	11
ER214R	4	14.0	11
ER215R	5	15.0	11
ER216R	6	16.5	11



MG149R-ER216R

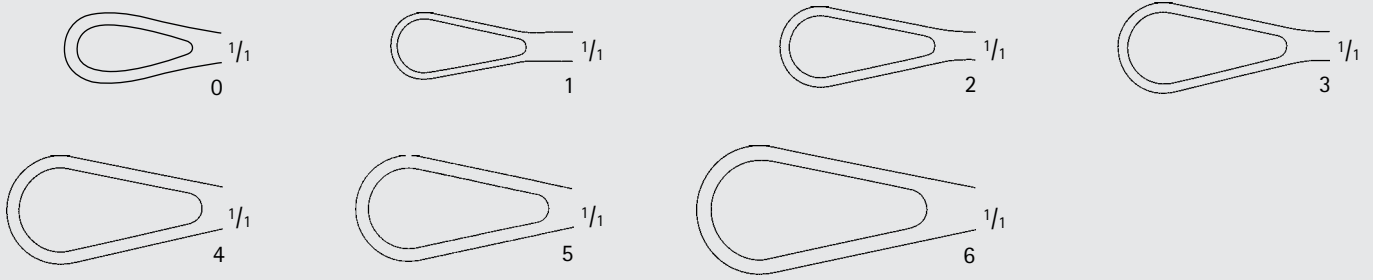

KELLY-GRAY Uterine Curette

Catalog Number	Tip Size (#)	Tip Size (mm)	Length (in.)
MB375R	1	5.0	9 1/2
MB376R	2	6.0	9 1/2
MB377R	3	7.5	9 1/2
MB378R	4	8.5	9 1/2



MB375R-MB378R



HEANEY Uterine Curette, Malleable

Catalog Number	Tip	Length (in.)
ER025R	TOOTHED	9 1/2



ER025R



ER025R

COLLIN Uterine Curette, Rigid

Catalog Number	Tip	Length (in.)
ER580R	TOOTHED	11 3/4



ER580R



ER580R

BLAKE Uterine Curette, Double Ended

Catalog Number	Tip	Length (in.)
ER585R	SHARP/BLUNT	10 3/4



ER585R



1/1

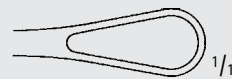

ER585R

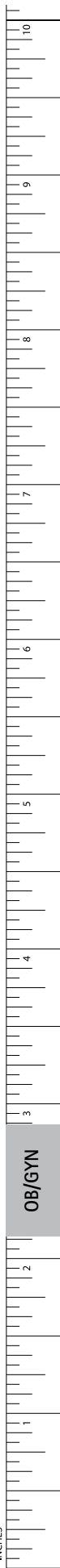

OB/GYN

INCHES

Obstetrics/Gynecology

Curettes

BUMM Uterine Curette

Catalog Number	Tip Size (#)	Tip Size (mm)	Tip	Length (in.)
ER621R	1	23.5	SHARP/MALL	12 1/4
ER623R	3	28.5	SHARP/MALL	12 1/4
ER626R	1	23.5	BLUNT/MALL	12 1/4
ER627R	2	26.0	BLUNT/MALL	12 1/4
ER628R	3	28.5	BLUNT/MALL	12 1/4



ER621R-ER628R

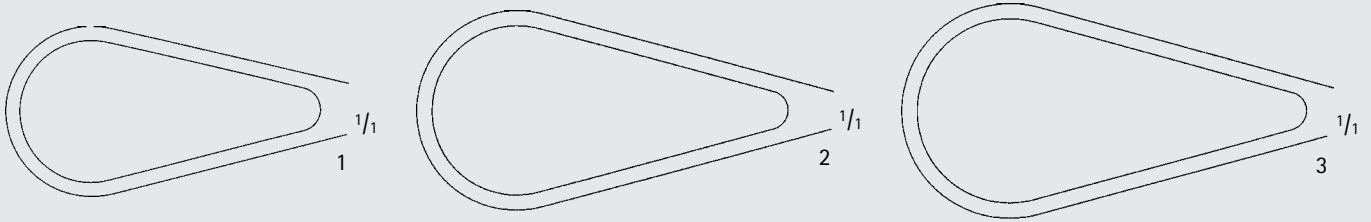

WALLICH Placenta/Ovum Scoop

Catalog Number	Tip	Length (in.)
ER602R	CVD	16 3/4



ER602R

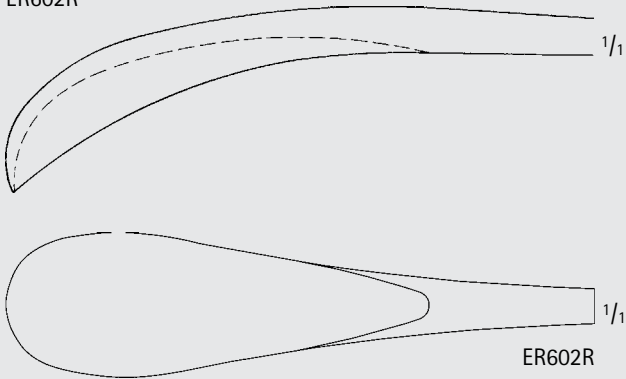

OB/GYN

MILLIMETERS

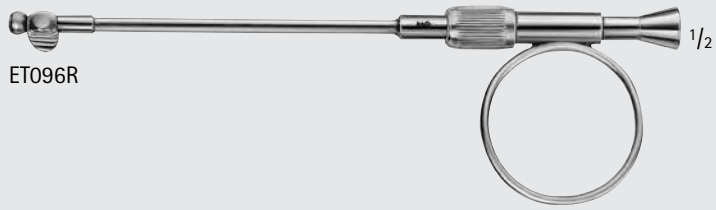

ET096R

Guide Sheath, IOWA Trumpet

Catalog Number	Tip Size (mm)	Description	Length (in.)
ET096R	—	—	6 7/8
SR580R	1 x 185	INJECTION NEEDLE, LUER-LOCK HUB	—

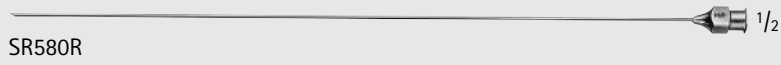

SR580R



ER876

Uterine Cannula W/ 2 Cones

Catalog Number	Length (in.)
ER876	13 3/4

- Cones:
1 ER876201 (small)
1 ER876202 (large)



Obstetrics/Gynecology

