





Neurosurgery

Skull Opening	1068 - 1073
Micro Scissors	1074 - 1077
Micro Forceps	1078 - 1079
Tumor Forceps	1079 - 1081
Micro Needle Holders	1082
MIN Instruments	1083 - 1087
SENSATION Instruments	1088 - 1095
XS Instruments	1096 - 1100
EC/IC Bypass Instruments	1101 - 1103
Skull Base Instruments	1104 - 1105
Micro Dissectors/Rasps/Hooks	1106 - 1122
Suture and Ligature Instruments	1123
Dural Separators	1124
Knives	1124 - 1126
Pituitary Instruments	1127 - 1143
Suction Cannulas	1144 - 1152
Elevators	1153
Retractors and Handrest Systems	1154 - 1162
Brain Spatulas	1163 - 1165

Neurosurgery

Skull Opening



FF007P

ScalpFix® Applicator, Polymer

Catalog Number
FF007P



FF012R

ScalpFix Applicator, Aluminum

Catalog Number
FF012R

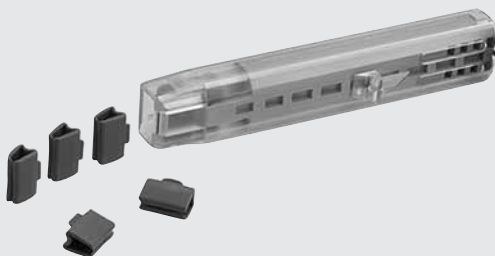

FF013P

ScalpFix Scalp Clip, Single Use

Catalog Number	Packaging
FF013P	BOX = 20 PAC OF 10 PC (200 CLIPS TOTAL)

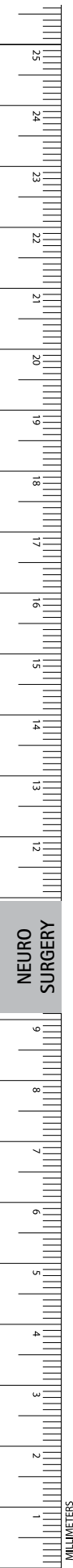

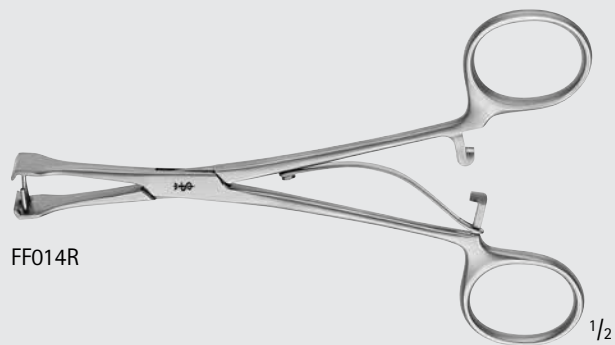

FF014R

1/2

ScalpFix® Removal Forceps

Catalog Number	Length (in.)
FF014R	6



FF015P

1/1

RANEY Plastic Scalp Hemostasis Clip, Sterile

Catalog Number	Sales Unit
FF015P	BOX = 20 PACK OF 10 PC (200 CLIPS TOTAL)

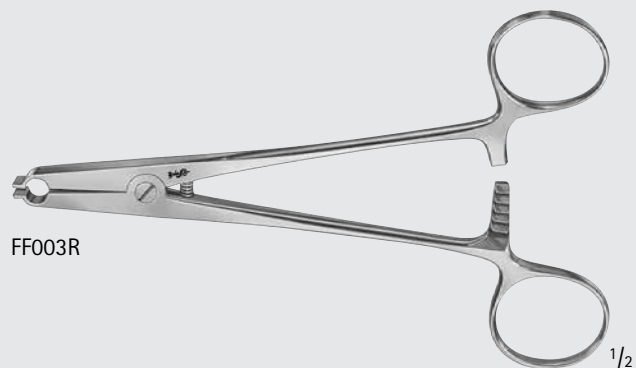

FF003R

1/2

RANEY Applying and Removing Forceps for Scalp Hemostasis Clips

Catalog Number	Compatible w/	Length (in.)
FF003R	FF015P	6 1/4



FF005R

1/2

Scalp Hemostasis Clip

Catalog Number	Sales Unit
FF005R	BOX OF 10

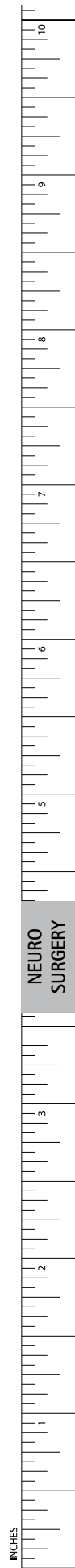

INCHES

Neurosurgery

Skull Opening

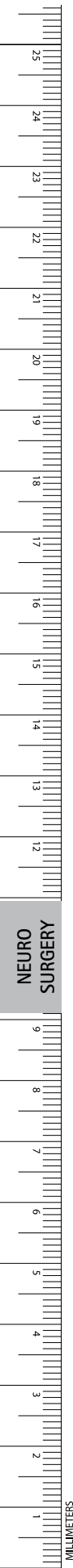

Scalp Flap Forceps

Catalog Number	Author	Shape	Length (in.)
FF010R	DEMARTEL	SLIGHT-CVD	5 1/4
FF011R	WILLETT-DEMARTEL	SLIGHT-CVD	7 1/4

FF010R-FF011R

FF010R 1/1

FF011R 1/1

YASARGIL Spring Hook, F/ Galea Fixation W/ Bulldog Clamp

Catalog Number	Tip
FF020R	SMALL
FF022R	LARGE

FF020R-FF022R

FF020R 1/1

FF022R 1/1

Galea Hook, W/ Ball Chain

Catalog Number	Compatible w/
FF155R	FF154R

FF155R



FF155R 1/1

Galea Hook, W/ Ball Chain and Spiral Spring

Catalog Number	Compatible w/
FF156R	FF154R

FF156R

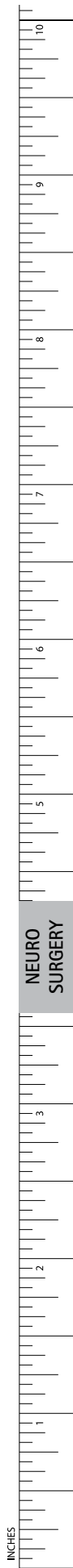
FF156R 1/1





FF056R

1/2

HUDSON Drill Brace

Catalog Number
FF056R



FF057R

1/2

HUDSON Drill Brace Extension

Catalog Number
FF057R

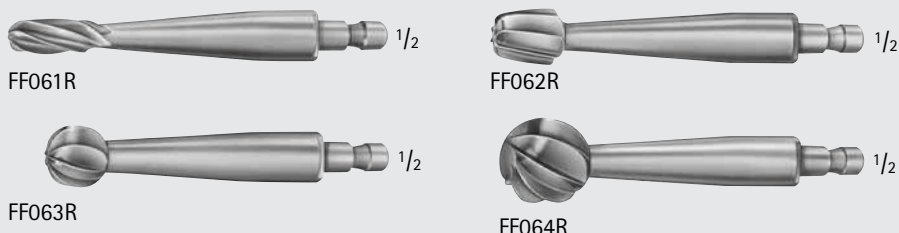

FF061R

FF062R

FF063R

FF064R

1/2

1/2

1/2

1/2

HUDSON Burr

Catalog Number	Diameter (mm)
FF061R	9.0
FF062R	14.0
FF063R	16.0
FF064R	22.0



FF065R

1/2

ADSON Burr

Catalog Number	Diameter (mm)
FF065R	15.0



FF066R

1/2

MCKENZIE Twist Drill

Catalog Number	Diameter (mm)
FF066R	13.0



FF067R

1/2

CUSHING Flat Drill

Catalog Number	Diameter (mm)
FF067R	14.0



FF068R

1/2

Twist Drill

Catalog Number	Diameter (mm)
FF068R	2.0

Neurosurgery

Skull Opening

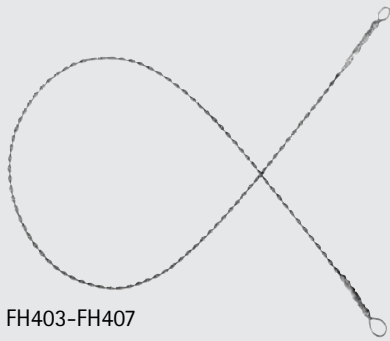

OLIVECRONA Wire Saw

Catalog Number	Diameter (mm)	Sales Unit	Length (in.)
FH403	1.2	BOX OF 5	11 3/4
FH404	1.2	BOX OF 5	15 3/4
FH405	1.2	BOX OF 5	19 3/4
FH407	1.2	BOX OF 5	27 1/2

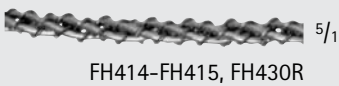
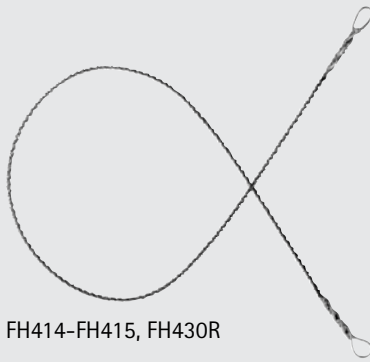

GIGLI Wire Saw

Catalog Number	Diameter (mm)	Wires	Sales Unit	Length (in.)
FH414	1.4	6	BOX OF 5	15 3/4
FH415	1.4	6	BOX OF 5	19 3/4
FH430R	1.8	4	BOX OF 5	19 3/4

NEURO SURGERY

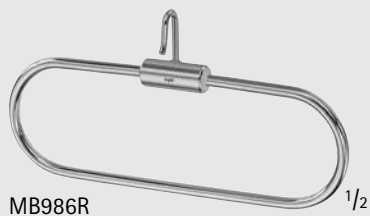

MB986R

1/2

GIGLI Saw Handle F/ Wire Saws

Catalog Number	Packaging
MB986R	2 PER PACKAGE



FH480R

1/2

GIGLI Hook Handle, F/ Wire Saws

Catalog Number	Packaging
FH480R	2/SET

1/2



FF130R

DEMARTEL Conductor

Catalog Number	Compatible w/	Length (in.)
FF130R	GIGLI AND OLIVECRONA WIRE SAWS	13 3/4

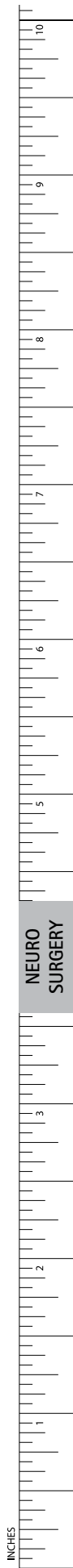

NEURO SURGERY

INCHES

Neurosurgery

Micro Scissors, Bayonet-Shaped

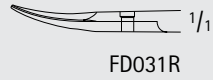
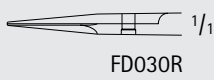

YASARGIL Micro Scissors

Catalog Number	Tip	Blade	Length (in.)
FD030R	S/S	STR	6 1/2
FD031R	S/S	CVD-UP	6 1/2

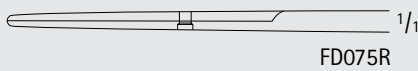

YASARGIL Micro Dissecting Scissors

Catalog Number	Tip	Blade	Length (in.)
FD075R	B/B	STR	7 1/4

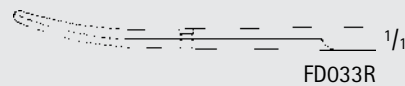
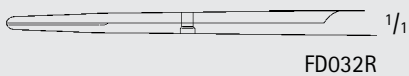

YASARGIL Micro Dissecting Scissors

Catalog Number	Tip	Blade	Length (in.)
FD032R	B/B	STR, SERR	7 7/8
FD033R	B/B	CVD-UP, SERR	7 7/8

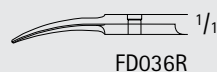
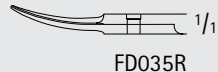
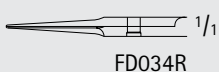

YASARGIL Micro Scissors

Catalog Number	Tip	Blade	Length (in.)
FD034R	S/S	STR, SERR	7 7/8
FD035R	S/S	CVD-UP, SERR	7 7/8
FD036R	S/S	CVD-DOWN, SERR	7 7/8

NEURO SURGERY

MILLIMETERS

Neurosurgery

Micro Scissors, Bayonet-Shaped

YASARGIL Micro Scissors

Catalog Number	Tip	Blade	Length (in.)
FD038R	S/S	STR	8 7/8
FD039R	S/S	CVD-UP	8 7/8
FD060R	S/S	STR, TOOTHED	8 7/8

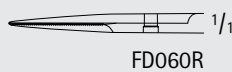
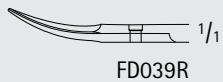
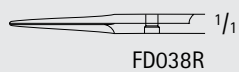

YASARGIL Micro Dissecting Scissors

Catalog Number	Tip	Blade	Length (in.)
FD044R	S/S	STR	8 7/8
FD043R	S/S	CVD-UP	8 7/8

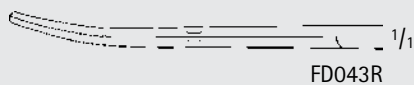
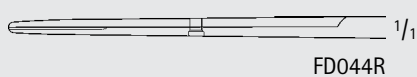

YASARGIL Micro Scissors

Catalog Number	Tip	Blade	Length (in.)
FD037R	S/S	STR	8 7/8
FD040R	S/S	CVD-UP	8 7/8

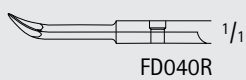
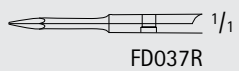

YASARGIL Micro Scissors

Catalog Number	Tip	Blade	Length (in.)
FD061R	S/S	CVD-UP	9 5/8

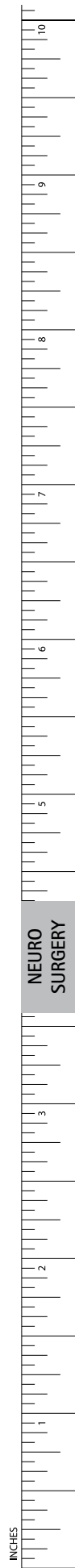
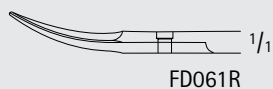

NEURO SURGERY

INCHES

Neurosurgery

Micro Scissors, Bayonet-Shaped



FD062R

YASARGIL Wire Cutting Scissors

Catalog Number	Tip	Blade	Length (in.)
FD062R	S/S	1-SERR	8 1/4



FD062R



FD105R-FD108R

Micro Vessel Scissors

Catalog Number	Tip	Blade	Length (in.)
FD105R	S/S	STR	7 1/2
FD106R	S/S	CVD	7 1/2
FD107R	S/S	DEL, STR	7 1/2
FD108R	S/S	DEL, CVD	7 1/2

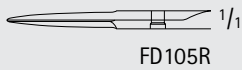

FD105R

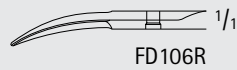

FD106R

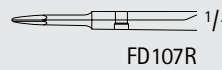

FD107R

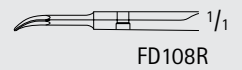

FD108R

NEURO SURGERY

Neurosurgery

Micro Scissors, Bayonet-Shaped



FD056R-FD057R

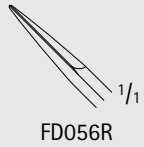

FD056R

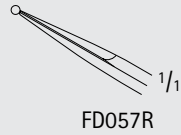

FD057R

NAGEL Micro Scissors

Catalog Number	Tip	Blade	Length (in.)
FD056R	S/S	45°	7 7/8
FD057R	1 BALL-PT	45°	7 7/8

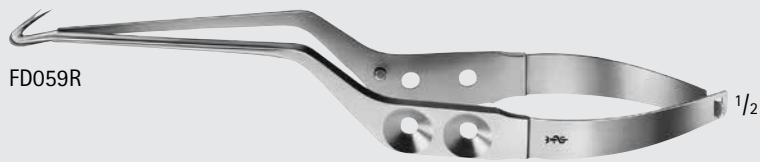

FD059R



FD059R

DEBAKEY Circumflex Micro Scissors

Catalog Number	Tip	Blade	Length (in.)
FD059R	S/S	125°	7 1/2

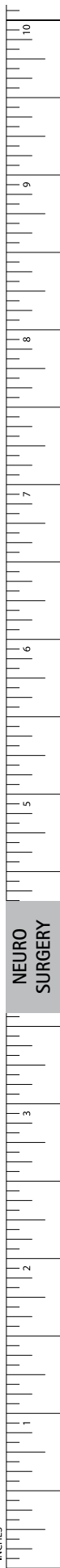

INCHES

Neurosurgery

Micro Forceps

BD835R-BD837R



YASARGIL Micro Forceps, Bayonet-Shaped

Catalog Number	Tip Size (mm)	Teeth	Length (in.)
BD835R	0.6	-	7
BD836R	0.9	-	7
BD837R	-	1 x 2	7

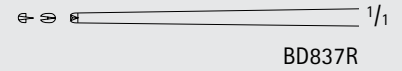
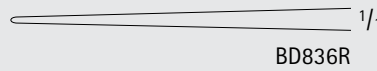
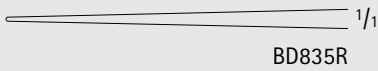

BD840R-BD841R

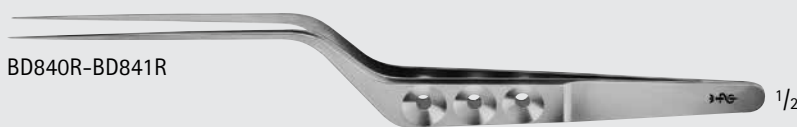

YASARGIL Micro Forceps, Bayonet-Shaped

Catalog Number	Tip Size (mm)	Length (in.)
BD840R	0.6	7 7/8
BD841R	0.9	7 7/8

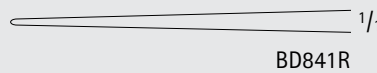
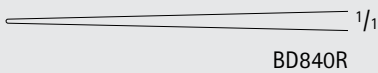

BD845R-BD846R



YASARGIL Micro Forceps, Bayonet-Shaped

Catalog Number	Tip Size (mm)	Length (in.)
BD845R	0.6	8 3/4
BD846R	0.9	8 3/4

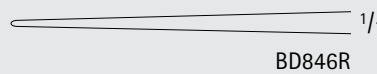
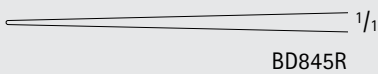

BD850R-BD851R



YASARGIL Micro Forceps, Bayonet-Shaped

Catalog Number	Tip Size (mm)	Length (in.)
BD850R	0.6	9 1/2
BD851R	0.9	9 1/2

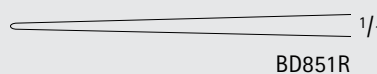
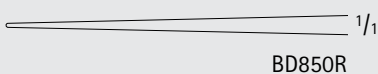

NEURO SURGERY



BD888R

1/2

**Gruenwald Micro Forceps,
Bayonet-Shaped**

Catalog Number	Teeth	Length (in.)
BD888R	1 x 2	6 1/4

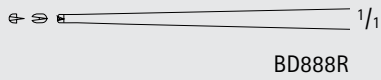

BD888R

1/1



MD536R

1/2

PENFIELD Watchmaker Forceps

Catalog Number	Length (in.)
MD536R	7



MD536R

1/1



BD765R

1/2

**HUNT Grasping Forceps,
Bayonet-Shaped**

Catalog Number	Tip	Shape	Diameter (mm)	Length (in.)
BD765R	ANG	STR	4.5	7 7/8

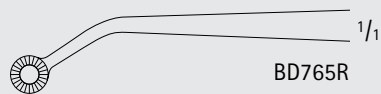

BD765R

1/1

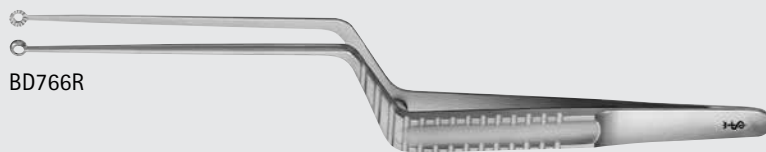

BD766R

**HUNT Grasping Forceps,
Bayonet-Shaped**

Catalog Number	Tip	Shape	Diameter (mm)	Length (in.)
BD766R	STR	BAYONET	4.5	7 7/8

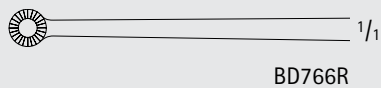

BD766R

1/1

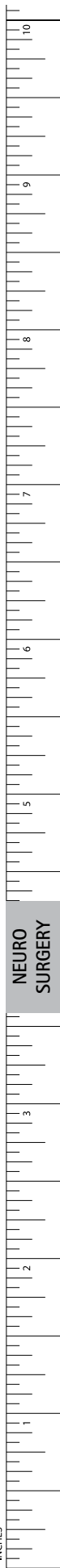

INCHES

Neurosurgery

Tumor Forceps

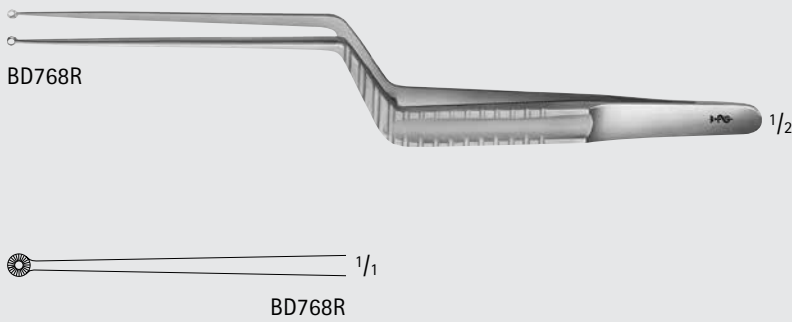

**YASARGIL Grasping Forceps,
Bayonet-Shaped**

Catalog Number	Tip	Shape	Diameter (mm)	Length (in.)
BD768R	STR	BAYONET	3.0	7 7/8

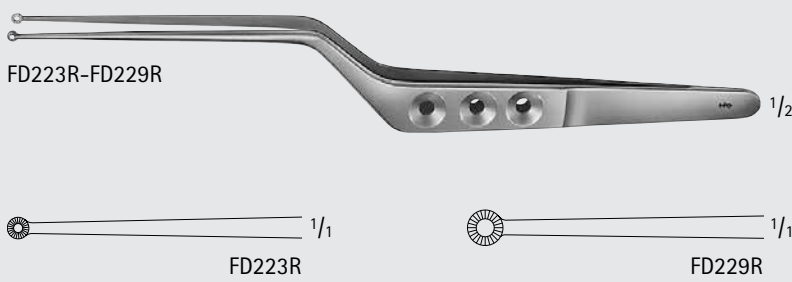

**YASARGIL Micro Forceps,
Bayonet-Shaped**

Catalog Number	Diameter (mm)	Length (in.)
FD223R	3.0	7 7/8
FD229R	5.0	7 7/8

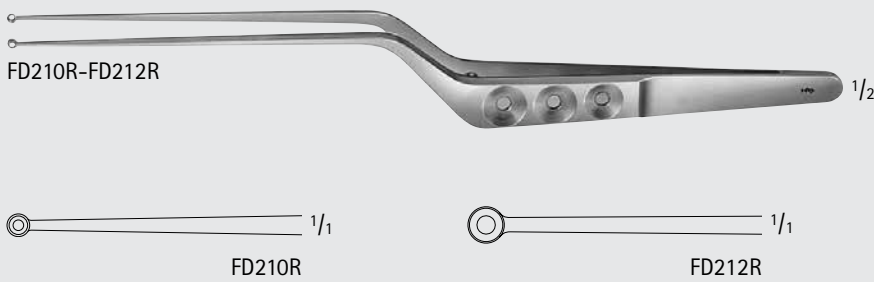

**YASARGIL Grasping Forceps,
Bayonet-Shaped**

Catalog Number	Jaw	Diameter (mm)	Length (in.)
FD210R	SPOON-SHAPED	3.0	8 3/4
FD212R	SPOON-SHAPED	5.0	8 3/4

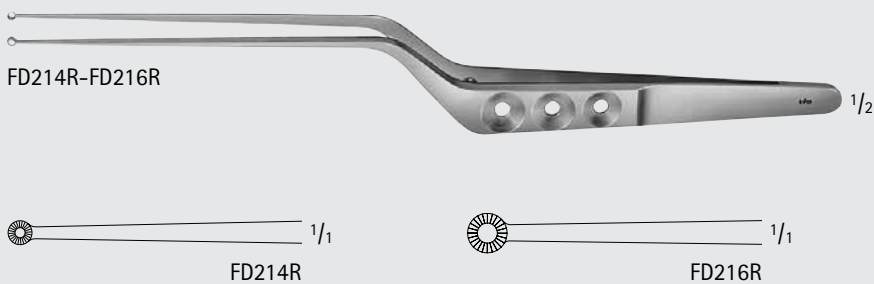

**YASARGIL Grasping Forceps,
Bayonet-Shaped**

Catalog Number	Jaw	Diameter (mm)	Length (in.)
FD214R	FLAT/SERR	3.0	8 3/4
FD216R	FLAT/SERR	5.0	8 3/4

NEURO SURGERY



**HEIFETZ Grasping Forceps,
Bayonet-Shaped**

Catalog Number	Jaw	Diameter (mm)	Length (in.)
FD215R	CURETTE, TOOTHED	3.0	8 3/4
FD217R	CURETTE, TOOTHED	5.0	8 3/4

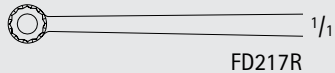
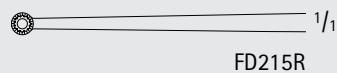

**YASARGIL-SAMII Grasping Forceps,
Bayonet-Shaped**

Catalog Number	Jaw	Diameter (mm)	Length (in.)
FD200R	SPOON-SHAPED	3.0	9 1/2
FD202R	SPOON-SHAPED	5.0	9 1/2
FD204R	SPOON-SHAPED	7.0	9 1/2

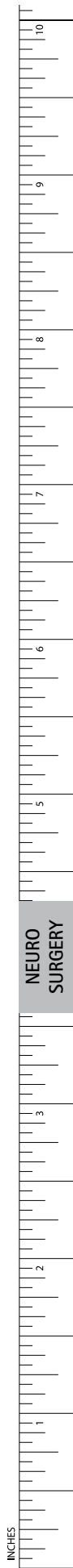
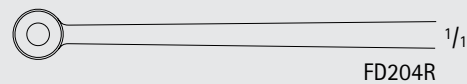
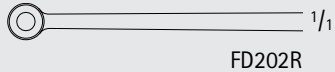
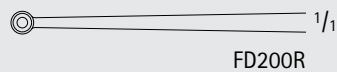

Neurosurgery

Micro Needle Holder, Bayonet-Shaped



FD092R-FD093R

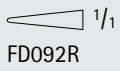

FD092R

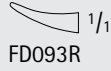

FD093R

YASARGIL Micro Needle Holder

Catalog Number	Tip	Length (in.)
FD092R	STR	7 7/8
FD093R	CVD-UP	7 7/8



FD096R-FD097R

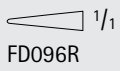

FD096R

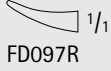

FD097R

YASARGIL Micro Needle Holder

Catalog Number	Tip	Length (in.)
FD096R	STR	8 7/8
FD097R	CVD-UP	8 7/8

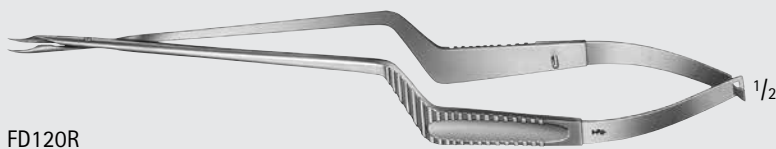

FD120R

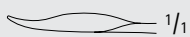

Micro Needle Holder

Catalog Number	Tip	Length (in.)
FD120R	CVD-UP	7 3/4

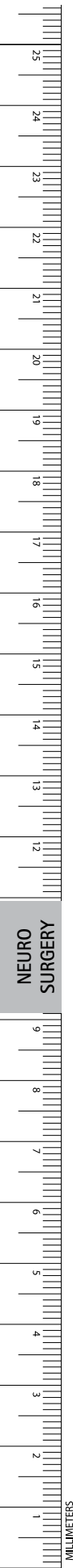

NEURO SURGERY

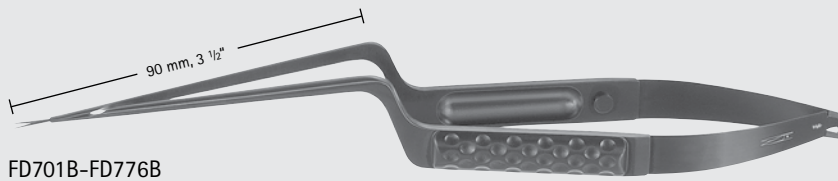

MIN, Noir Micro Scissors W/ Golfball Handle, Serrated Blades

Catalog Number	Tip	Blade	Working Length (in.)	Length (in.)
FD701B	S/S	STR	2 3/4	7 7/8
FD702B	S/S	SLIGHT-CVD	2 3/4	7 7/8
FD703B	S/S	CVD	2 3/4	7 7/8
FD704B	B/B	STR	2 3/4	7 7/8
FD705B	B/B	SLIGHT-CVD	2 3/4	7 7/8
FD706B	B/B	CVD	2 3/4	7 7/8
FD731B	S/S	STR	3 1/2	8 3/4
FD732B	S/S	SLIGHT-CVD	3 1/2	8 3/4
FD733B	S/S	CVD	3 1/2	8 3/4
FD734B	B/B	STR	3 1/2	8 3/4
FD735B	B/B	SLIGHT-CVD	3 1/2	8 3/4
FD736B	B/B	CVD	3 1/2	8 3/4
FD771B	S/S	STR	4 3/4	9 3/4
FD772B	S/S	SLIGHT-CVD	4 3/4	9 3/4
FD773B	S/S	CVD	4 3/4	9 3/4
FD774B	B/B	STR	4 3/4	9 3/4
FD775B	B/B	SLIGHT-CVD	4 3/4	9 3/4
FD776B	B/B	CVD	4 3/4	9 3/4

FD701B-FD776B



FD701B, FD704B



FD702B, FD705B

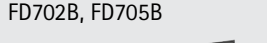

FD703B, FD706B



FD701B-FD703B

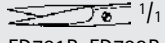

FD704B-FD706B

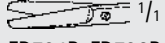

FD731B, FD734B



FD732B-FD735B



FD733B-FD736B

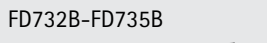

FD731B-FD733B



FD734B-FD736B

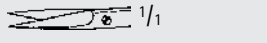

FD771B, FD774B

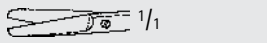

FD772B, FD775B



FD773B, FD776B

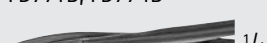

FD771B-FD773B

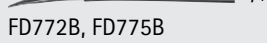

FD774B-FD776B



FD771B-FD773B

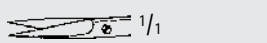

FD774B-FD776B

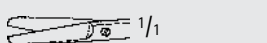

FD771B-FD773B



FD774B-FD776B

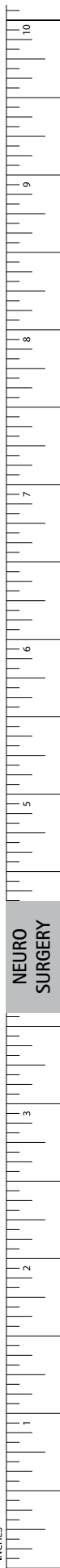

Neurosurgery

MIN Instruments - Noir™ Micro Needle Holders/Noir™ Micro Tissue Forceps/Noir™ Micro Tumor Forceps, Bayonet-Shaped



FD717B-FD719B



FD717B-FD719B

MIN, Noir Micro Needle Holder W/ Golfball Handle

Catalog Number	Suture Size	Working Length (mm)	Length (in.)
FD717B	7/0 AND SMALLER	70	7 7/8
FD718B	7/0 AND SMALLER	90	8 3/4
FD719B	7/0 AND SMALLER	120	9 3/4

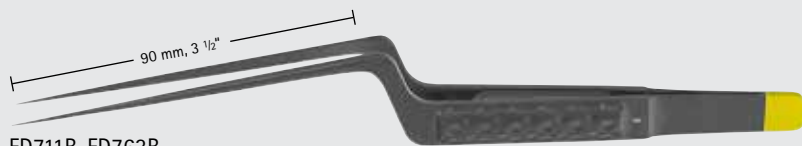

FD711B-FD763B

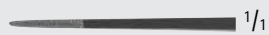

FD711B, FD741B, FD761B

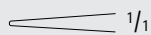

FD713B, FD743B, FD763B

MIN, Noir Micro Tissue Forceps W/ Golfball Handle

Catalog Number	Tip	Tip Size (mm)	Working Length (in.)	Length (in.)
FD711B	STR	0.5	2 3/4	7 1/2
FD713B	STR	0.9	2 3/4	7 1/2
FD741B	STR	0.5	3 1/2	8 1/4
FD743B	STR	0.9	3 1/2	8 1/4
FD761B	STR	0.5	4 3/4	9 1/2
FD763B	STR	0.9	4 3/4	9 1/2

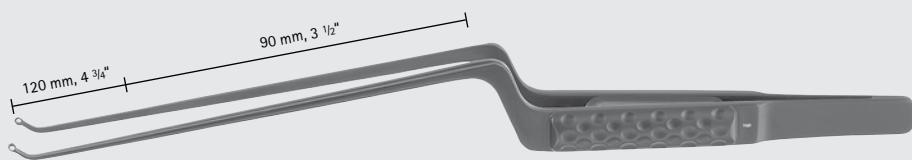

FD767B-FD789B



FD766B, FD769B, FD786B, FD789B



FD767B, FD787B

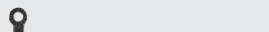

FD768B, FD788B



FD766B-FD768B, FD786B-FD788B



FD769B, FD789B

MIN, Noir Micro Tumor Forceps W/ Golfball Handle

Catalog Number	Tip	Tip Size (mm)	Working Length (in.)	Length (in.)
FD766B	STR	2.5 RING	3 1/2	8 1/4
FD769B	STR	3.5 RING	3 1/2	8 1/4
FD767B	45° CVD	2.5 RING	3 1/2	8 1/4
FD768B	90° CVD	2.5 RING	3 1/2	8 1/4
FD786B	STR	2.5 RING	4 3/4	9 1/2
FD789B	STR	3.5 RING	4 3/4	9 1/2
FD787B	45° CVD	2.5 RING	4 3/4	9 1/2
FD788B	90° CVD	2.5 RING	4 3/4	9 1/2

NEURO SURGERY

MILLIMETERS

MIN Set

- Fine instrument tips
- Round golfball handle design
- Various working lengths
- Slender design and angled bayonet-shape
- Noir, No Irritating Reflections



FD811B



FD812B

MIN, Noir Modular Handle F/ Golfball Handle Design

Catalog Number	Diameter (mm)	Length (in.)
FD811B	8	4
FD812B	11	4



FD818B



FD819B



FD848B



FD849B

MIN, Noir Modular Bayonet Handle F/ Golfball Handle Design

Catalog Number	Diameter (mm)	Description	Length (in.)
FD818B	8	LOW BAYONET (21 MM)	4
FD819B	11	LOW BAYONET (31 MM)	4
FD848B	8	HIGH BAYONET (21 MM)	4
FD849B	11	HIGH BAYONET (31 MM)	4

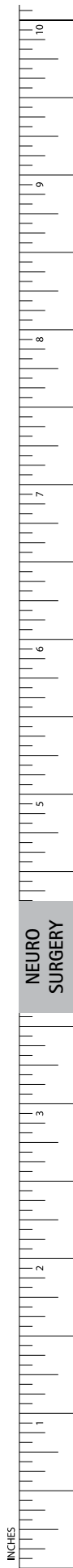

Neurosurgery

MIN Instruments - Noir™ Micro Dissectors/Noir™ Rasps/Noir™ Hooks

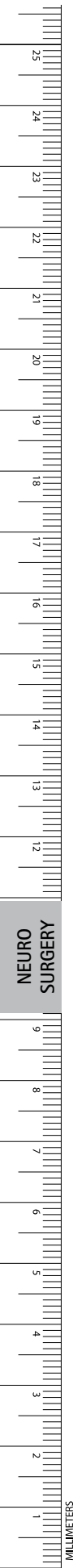

MIN, Noir Micro Probe F/ Modular Golfball Handle

Catalog Number	Tip	Length (in.)
FD797B	BALL-TIP 0°	7 7/8
FD798B	BALL-TIP 45°	7 7/8
FD799B	BALL-TIP 90°	7 7/8

FD797B-FD799B



MIN, Noir Micro Hook F/ Modular Golfball Handle

Catalog Number	Tip	Length (in.)
FD808B	45°, BLUNT	7 7/8
FD805B	90°, BLUNT	7 7/8
FD809B	90°, SHARP	7 7/8

FD805B-FD809B



MIN, Noir Micro Scoop F/ Modular Golfball Handle

Catalog Number	Tip	Tip Size (mm)	Length (in.)
FD814B	10°	2	7 7/8
FD815B	45°	2	7 7/8
FD816B	45° W/ NECK	2	7 7/8

FD814B-FD816B



MIN, Noir Micro Dissector F/ Modular Golfball Handle

Catalog Number	Tip	Tip Size (mm)	Length (in.)
FD821B	CVD	1.0	7 7/8
FD822B	CVD	2.0	7 7/8
FD823B	CVD	3.0	7 7/8

FD821B-FD823B



NEURO SURGERY

MIN, Noir Micro Raspatory F/ Modular Golfball Handle

Catalog Number	Tip	Tip Size (mm)	Length (in.)
FD831B	RING	DIAM. 1.0	7 7/8
FD832B	RING	DIAM. 2.0	7 7/8
FD833B	RING	DIAM. 3.0	7 7/8

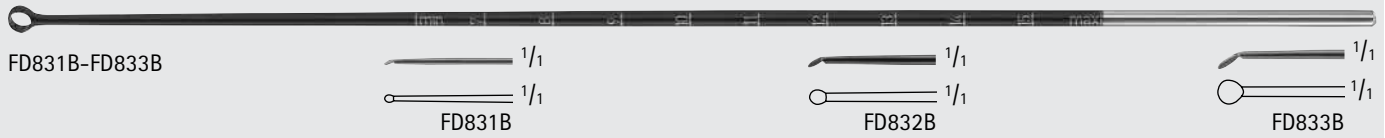

MIN, Noir Micro Tumor Knife F/ Modular Golfball Handle

Catalog Number	Tip	Tip Size (mm)	Length (in.)
FD839B	45°	DIAM. 1.5	7 7/8
FD840B	45°	DIAM. 3.0	7 7/8
FD841B	45°	DIAM. 4.5	7 7/8



MIN, Noir Micro Curette F/ Modular Golfball Handle

Catalog Number	Tip	Diameter (mm)	Length (in.)
FD824B	0°	4.0	7 7/8
FD825B	45°	4.0	7 7/8
FD826B	90°	4.0	7 7/8
FD827B	45° W/ NECK	4.0	7 7/8
FD828B	90° W/ NECK	4.0	7 7/8
FD835B	45°	6.5	7 7/8
FD836B	90°	6.5	7 7/8

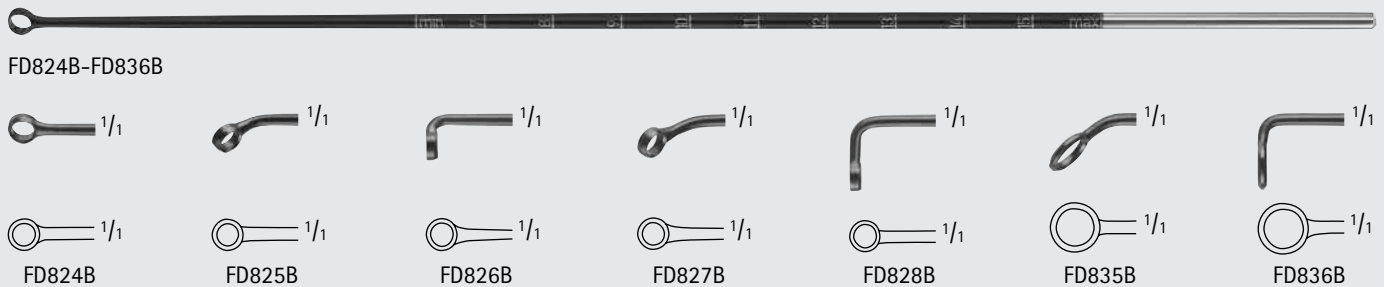

Storage Tray F/ MIN Micro Instruments

Catalog Number	Dimensions (mm)
FD467R	243 x 253 x 56



FD467R



Neurosurgery

SENSATION™ Noir™ Micro Scissors, Bayonet-Shaped

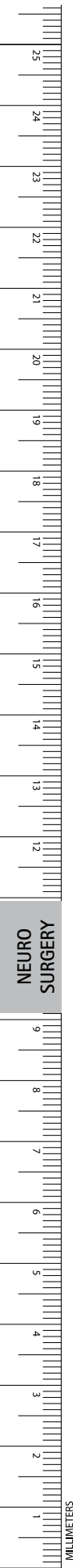

SENSATION Noir Micro Scissors

Catalog Number	Tip	Blade	Working Length (in.)	Length (in.)
FM146B	S/S	CVD-UP	2 3/8	7 1/4



SENSATION Noir Micro Scissors

Catalog Number	Tip	Blade	Working Length (in.)	Length (in.)
FM147B	S/S	CVD-UP	2 3/4	7 3/4

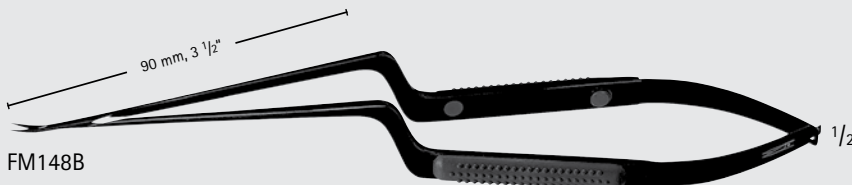

SENSATION Noir Micro Scissors

Catalog Number	Tip	Blade	Working Length (in.)	Length (in.)
FM148B	S/S	CVD-UP	3 1/2	8 1/2

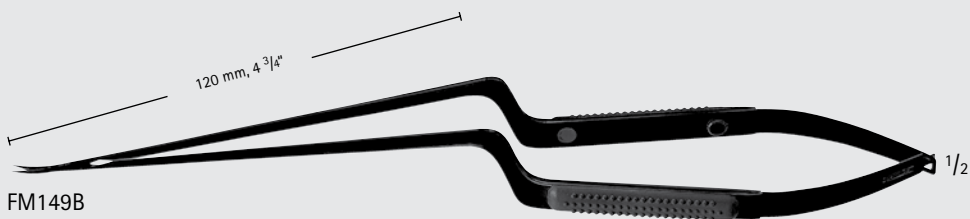

SENSATION Noir Micro Scissors

Catalog Number	Tip	Blade	Working Length (in.)	Length (in.)
FM149B	S/S	CVD-UP	4 3/4	9 5/8

NEURO SURGERY



FM120R-FM140R

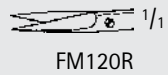

FM120R

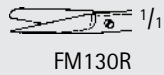

FM130R

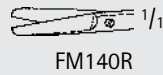

FM140R

SENSATION Micro Scissors

Catalog Number	Tip	Blade	Handle	Working Length (in.)	Length (in.)
FM120R	S/S	STR	BLUE	2 3/4	7 3/4
FM130R	S/B	STR	BLUE	2 3/4	7 3/4
FM140R	B/B	STR	BLUE	2 3/4	7 3/4

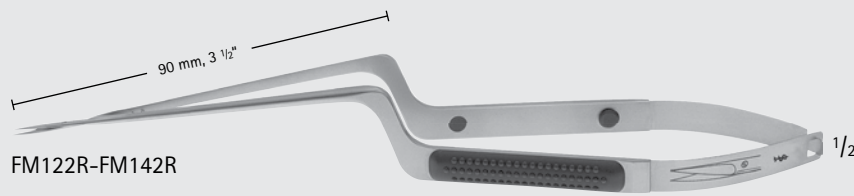

FM122R-FM142R

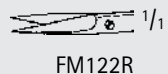

FM122R

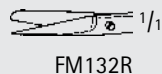

FM132R

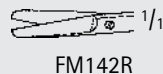

FM142R

SENSATION Micro Scissors

Catalog Number	Tip	Blade	Handle	Working Length (in.)	Length (in.)
FM122R	S/S	STR	BLUE	3 1/2	8 1/2
FM132R	S/B	STR	BLUE	3 1/2	8 1/2
FM142R	B/B	STR	BLUE	3 1/2	8 1/2

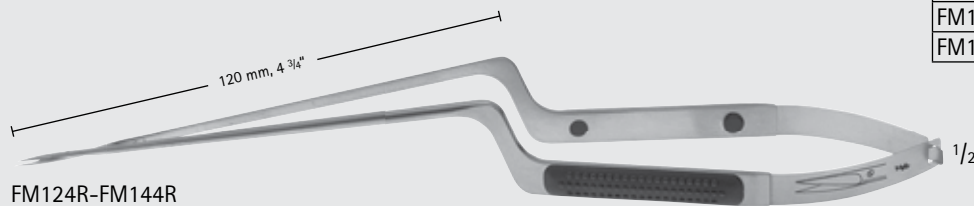

FM124R-FM144R

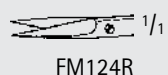

FM124R

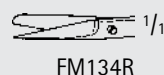

FM134R

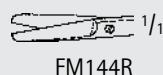

FM144R

SENSATION Micro Scissors

Catalog Number	Tip	Blade	Handle	Working Length (in.)	Length (in.)
FM124R	S/S	STR	BLUE	4 3/4	9 5/8
FM134R	S/B	STR	BLUE	4 3/4	9 5/8
FM144R	B/B	STR	BLUE	4 3/4	9 5/8

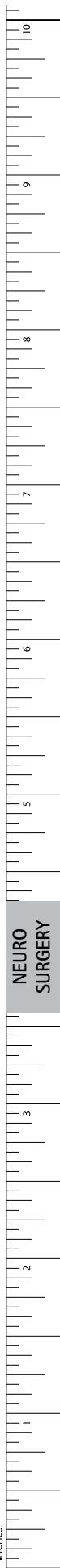

Neurosurgery

SENSATION™ Micro Scissors, Bayonet-Shaped

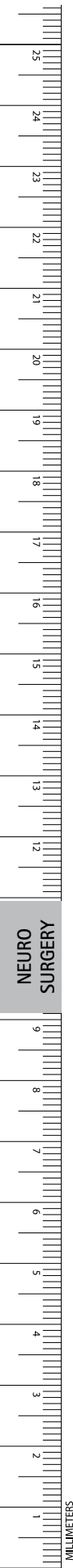

135 mm, 5 1/4"

FM159R-FM160R

1/1
FM159R

1/1
FM160R

SENSATION Micro Scissors

Catalog Number	Tip	Blade	Handle	Working Length (in.)	Length (in.)
FM159R	S/S	STR	BLUE	5 1/4	10 1/4
FM160R	B/B	STR	BLUE	5 1/4	10 1/4

70 mm, 2 3/4"

FM121R-FM141R

1/1
FM121R

1/1
FM131R

1/1
FM141R

SENSATION Micro Scissors

Catalog Number	Tip	Blade	Handle	Working Length (in.)	Length (in.)
FM121R	S/S	CVD-UP	BLUE	2 3/4	7 3/4
FM131R	S/B	CVD-UP	BLUE	2 3/4	7 3/4
FM141R	B/B	CVD-UP	BLUE	2 3/4	7 3/4

90 mm, 3 1/2"

FM123R-FM143R

1/1
FM123R

1/1
FM133R

1/1
FM143R

SENSATION Micro Scissors

Catalog Number	Tip	Blade	Handle	Working Length (in.)	Length (in.)
FM123R	S/S	CVD-UP	BLUE	3 1/2	8 1/2
FM133R	S/B	CVD-UP	BLUE	3 1/2	8 1/2
FM143R	B/B	CVD-UP	BLUE	3 1/2	8 1/2

SENSATION Micro Scissors

Catalog Number	Tip	Blade	Handle	Working Length (in.)	Length (in.)
FM125R	S/S	CVD-UP	BLUE	4 3/4	9 5/8
FM135R	S/B	CVD-UP	BLUE	4 3/4	9 5/8
FM145R	B/B	CVD-UP	BLUE	4 3/4	9 5/8

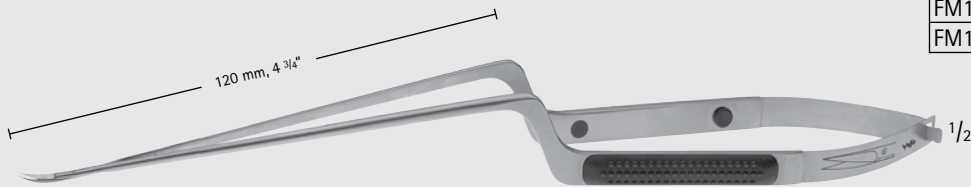

FM125R-FM145R

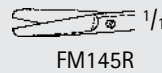
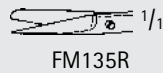
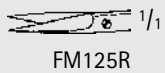

SENSATION Micro Scissors

Catalog Number	Tip	Blade	Handle	Working Length (in.)	Length (in.)
FM161R	S/S	CVD-UP	BLUE	5 1/4	10 1/4
FM162R	B/B	CVD-UP	BLUE	5 1/4	10 1/4

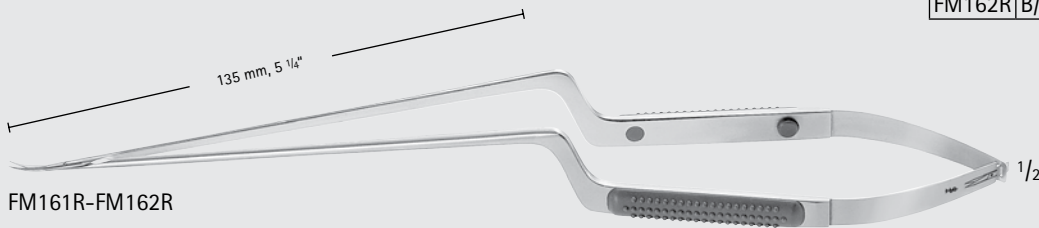

FM161R-FM162R

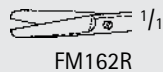
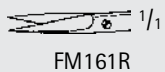

SENSATION Micro Scissors

Catalog Number	Tip	Blade	Handle	Working Length (in.)	Length (in.)
FM163R	S/S	CVD-DOWN	BLUE	3 1/2	8 1/2
FM164R	B/B	CVD-DOWN	BLUE	3 1/2	8 1/2

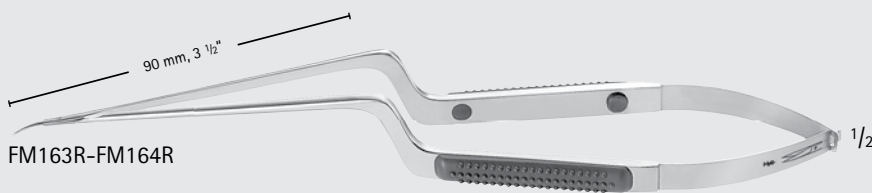

FM163R-FM164R

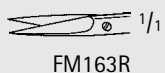

Neurosurgery

SENSATION™ Micro Scissors, Bayonet-Shaped

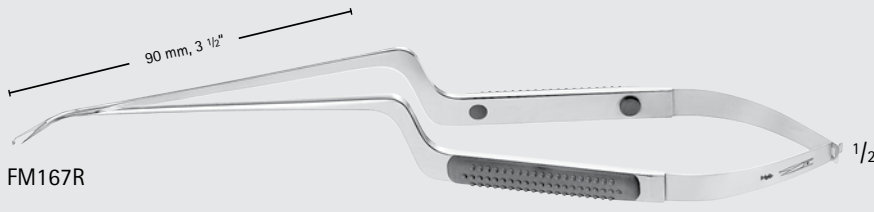
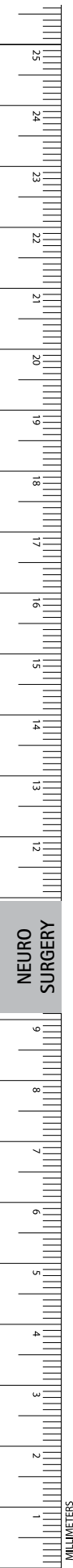

FM167R



FM167R

SENSATION Micro Scissors

Catalog Number	Tip	Blade	Handle	Working Length (in.)	Length (in.)
FM167R	1 BALL-POINT	45° LATERAL ANG	BLUE	3 1/2	8 1/2

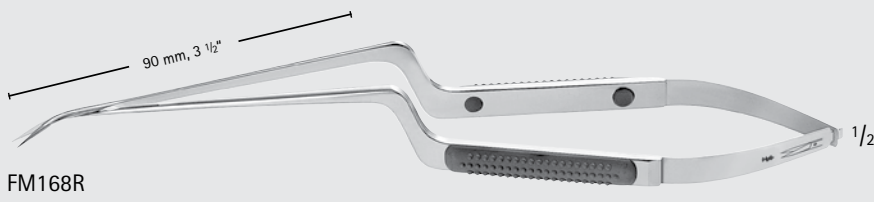

FM168R



FM168R

SENSATION Micro Scissors

Catalog Number	Tip	Blade	Handle	Working Length (in.)	Length (in.)
FM168R	B/B	45° LATERAL ANG	BLUE	3 1/2	8 1/2

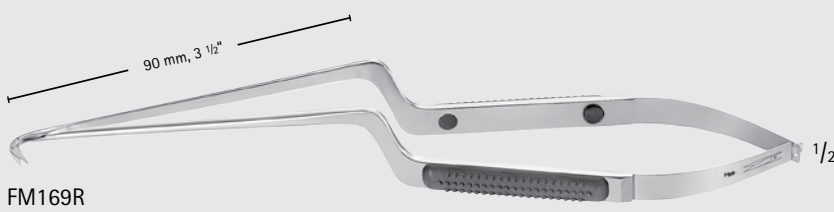

FM169R



FM169R

SENSATION Micro Scissors

Catalog Number	Tip	Blade	Handle	Working Length (in.)	Length (in.)
FM169R	B/B	125° LATERAL ANG	BLUE	3 1/2	8 1/2

NEURO SURGERY

Neurosurgery

SENSATION™ Micro Forceps, Bayonet-Shaped

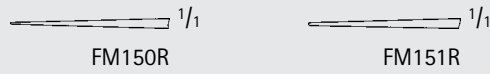
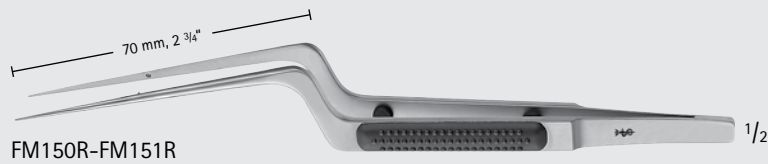

SENSATION Micro Forceps

Catalog Number	Tip Size (mm)	Handle	Working Length (in.)	Length (in.)
FM150R	0.5	BLACK	2 3/4	7 1/2
FM151R	0.9	BLACK	2 3/4	7 1/2

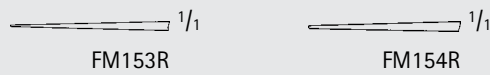
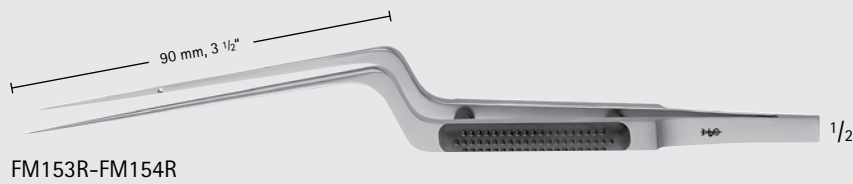

SENSATION Micro Forceps

Catalog Number	Tip Size (mm)	Handle	Working Length (in.)	Length (in.)
FM153R	0.5	BLACK	3 1/2	8 1/4
FM154R	0.9	BLACK	3 1/2	8 1/4

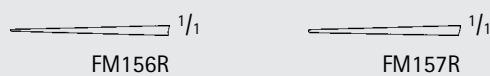
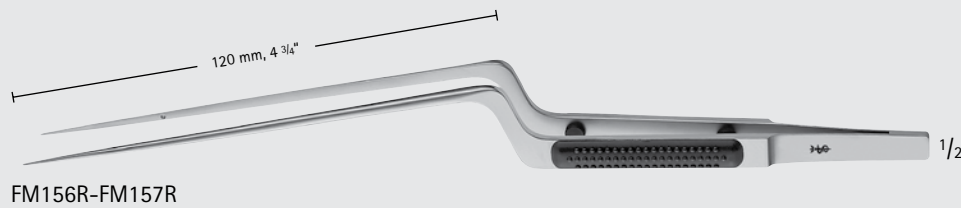

SENSATION Micro Forceps

Catalog Number	Tip Size (mm)	Handle	Working Length (in.)	Length (in.)
FM156R	0.5	BLACK	4 3/4	9 1/2
FM157R	0.9	BLACK	4 3/4	9 1/2



Neurosurgery

SENSATION™ Tumor Grasper, Bayonet-Shaped

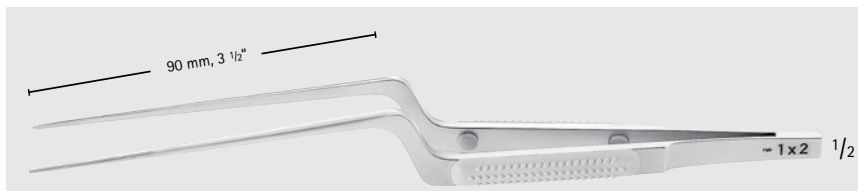
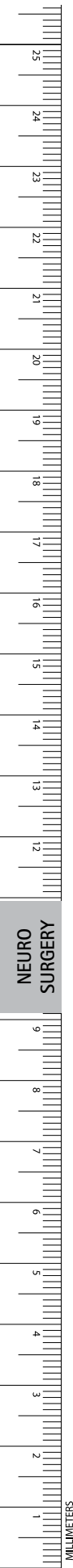

FM174R



FM174R

SENSATION Tumor Grasper

Catalog Number	Jaw	Teeth	Handle	Working Length (in.)	Length (in.)
FM174R	THIN TOOTH	1 x 2	YELLOW	3 1/2	8 1/4

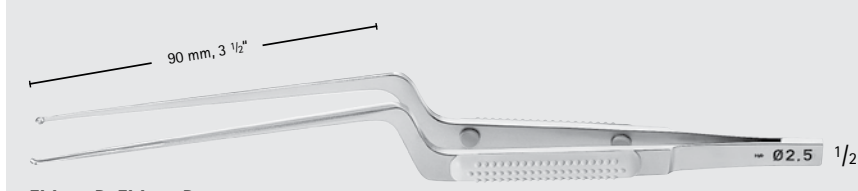

FM176R-FM177R



FM176R-FM177R

SENSATION Tumor Grasper

Catalog Number	Jaw	Jaw Size (mm)	Handle	Working Length (in.)	Length (in.)
FM176R	SERR	DIAM. 2.5	YELLOW	3 1/2	8 1/4
FM177R	SERR	DIAM. 3.5	YELLOW	3 1/2	8 1/4

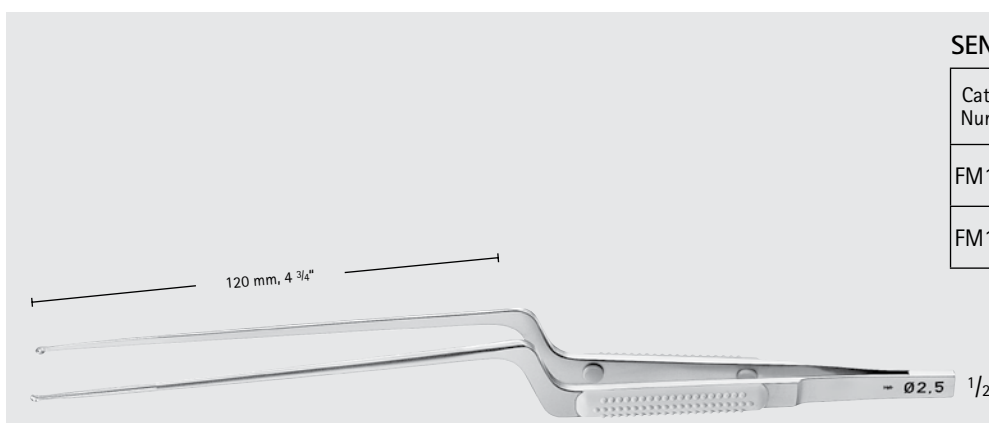

FM178R-FM179R



FM178R-FM179R

SENSATION Tumor Grasper

Catalog Number	Jaw	Jaw Size (mm)	Handle	Working Length (in.)	Length (in.)
FM178R	SERR	DIAM. 2.5	YELLOW	4 3/4	9 1/2
FM179R	SERR	DIAM. 3.5	YELLOW	4 3/4	9 1/2

NEURO SURGERY

70 mm, 2 3/4"

FM170R

1/2

1/1

FM170R

SENSATION Micro Needle Holder

Catalog Number	Jaw Size (mm)	Handle	Working Length (in.)	Length (in.)
FM170R	0.5	GREEN	2 3/4	7 3/4

90 mm, 3 1/2"

FM173R

1/2

1/1

FM173R

SENSATION Micro Needle Holder

Catalog Number	Jaw Size (mm)	Handle	Working Length (in.)	Length (in.)
FM173R	0.5	GREEN	3 1/2	8 1/2

120 mm, 4 3/4"

FM175R

1/2

1/1

FM175R

SENSATION Micro Needle Holder

Catalog Number	Jaw Size (mm)	Handle	Working Length (in.)	Length (in.)
FM175R	2.5	GREEN	4 3/4	9 5/8



NEURO SURGERY

INCHES

Neurosurgery

XS Micro Scissors, Bayonet-Shaped

XS Micro Scissors

Catalog Number	Tip	Blade	Item	Working Length (in.)	Length (in.)
FM670R	S/S	STR	COMPLETE	2 3/4	7 7/8
FM675R	S/S	STR	JAW INSERT	2 3/4	-
FM690R	B/B	STR	COMPLETE	2 3/4	7 7/8
FM695R	B/B	STR	JAW INSERT	2 3/4	-
FM730R	-	-	HANDLE	-	-

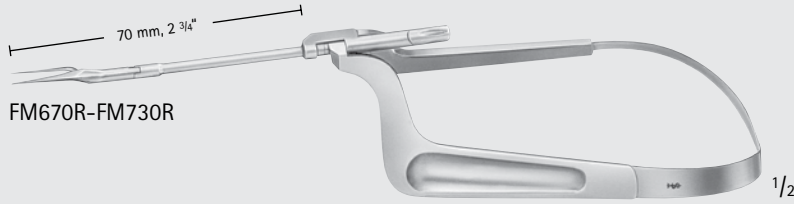

XS Micro Scissors

Catalog Number	Tip	Blade	Item	Working Length (in.)	Length (in.)
FM671R	S/S	STR	COMPLETE	4	9
FM676R	S/S	STR	JAW INSERT	4	-
FM691R	B/B	STR	COMPLETE	4	9
FM696R	B/B	STR	JAW INSERT	4	-
FM731R	-	-	HANDLE	-	-

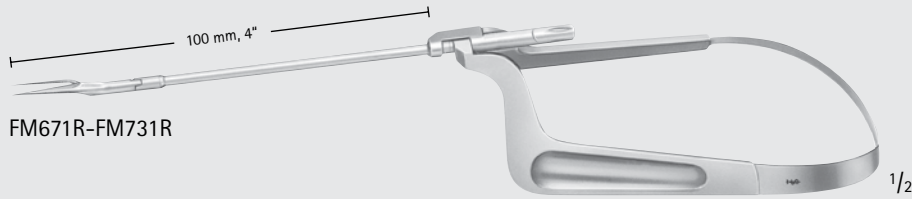

XS Micro Scissors

Catalog Number	Tip	Blade	Item	Working Length (in.)	Length (in.)
FM672R	S/S	STR	COMPLETE	5 1/8	10 1/4
FM677R	S/S	STR	JAW INSERT	5 1/8	-
FM692R	B/B	STR	COMPLETE	5 1/8	10 1/4
FM697R	B/B	STR	JAW INSERT	5 1/8	-
FM732R	-	-	HANDLE	-	-

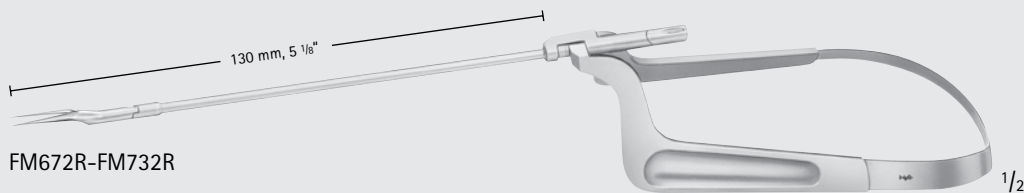

Neurosurgery

XS Micro Scissors, Bayonet-Shaped

XS Micro Scissors

Catalog Number	Tip	Blade	Item	Working Length (in.)	Length (in.)
FM680R	S/S	CVD	COMPLETE	2 3/4	7 7/8
FM685R	S/S	CVD	JAW INSERT	2 3/4	-
FM700R	B/B	CVD	COMPLETE	2 3/4	7 7/8
FM705R	B/B	CVD	JAW INSERT	2 3/4	-
FM730R	-	-	HANDLE	-	-

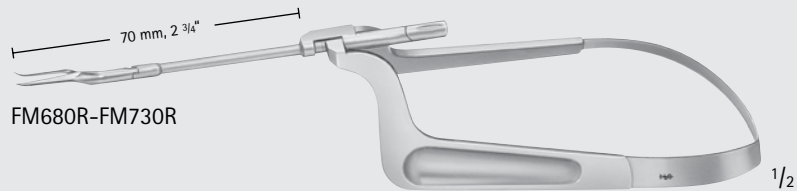

XS Micro Scissors

Catalog Number	Tip	Blade	Item	Working Length (in.)	Length (in.)
FM681R	S/S	CVD	COMPLETE	4	9
FM686R	S/S	CVD	JAW INSERT	4	-
FM701R	B/B	CVD	COMPLETE	4	9
FM706R	B/B	CVD	JAW INSERT	4	-
FM731R	-	-	HANDLE	-	-

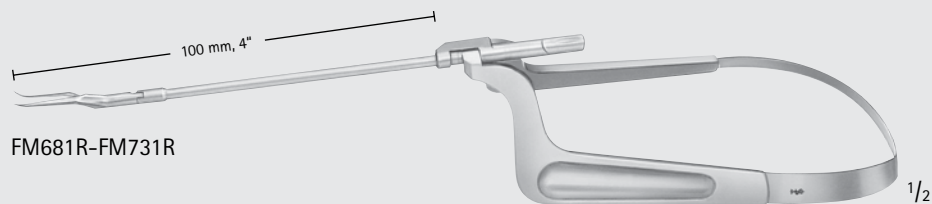

XS Micro Scissors

Catalog Number	Tip	Blade	Item	Working Length (in.)	Length (in.)
FM682R	S/S	CVD	COMPLETE	5 1/8	10 1/4
FM687R	S/S	CVD	JAW INSERT	5 1/8	-
FM702R	B/B	CVD	COMPLETE	5 1/8	10 1/4
FM707R	B/B	CVD	JAW INSERT	5 1/8	-
FM732R	-	-	HANDLE	-	-

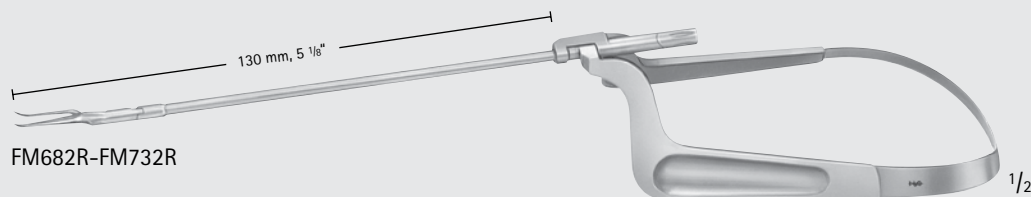

NEURO SURGERY

INCHES

Neurosurgery

XS Micro Forceps, Bayonet-Shaped

XS Micro Forceps

Catalog Number	Jaw Size (mm)	Item	Working Length (in.)	Length (in.)
FM710R	0.9	COMPLETE	2 3/4	7 7/8
FM715R	0.9	JAW INSERT	2 3/4	-
FM730R	-	HANDLE	-	-

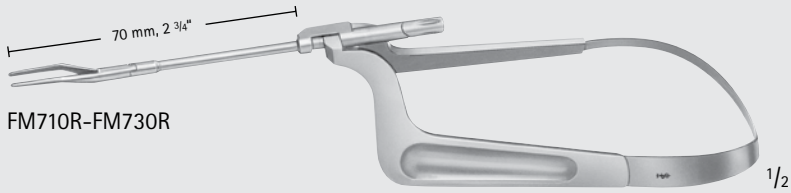

XS Micro Forceps

Catalog Number	Jaw Size (mm)	Item	Working Length (in.)	Length (in.)
FM711R	0.9	COMPLETE	4	9
FM716R	0.9	JAW INSERT	4	-
FM731R	-	HANDLE	-	-

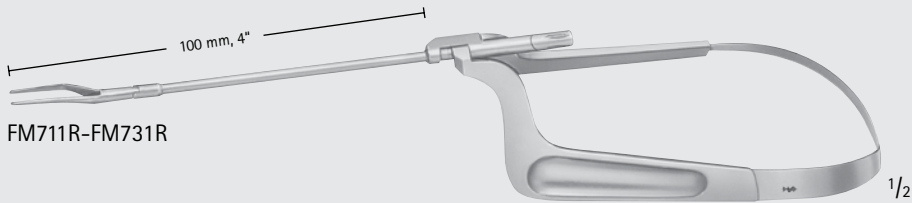

XS Micro Forceps

Catalog Number	Jaw Size (mm)	Item	Working Length (in.)	Length (in.)
FM712R	0.9	COMPLETE	5 1/8	10 1/4
FM717R	0.9	JAW INSERT	5 1/8	-
FM732R	-	HANDLE	-	-

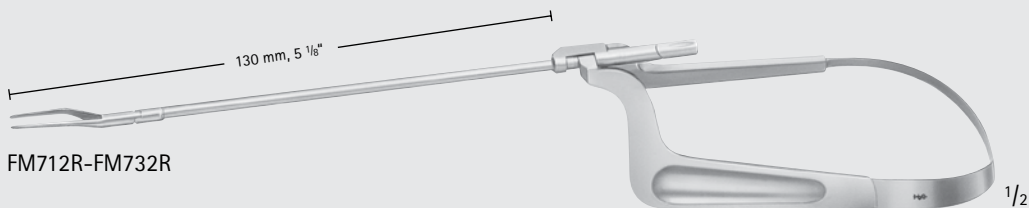

NEURO SURGERY

Neurosurgery

XS Micro Forceps, Bayonet-Shaped

XS Micro Tumor Grasping Forceps

Catalog Number	Jaw Size (mm)	Jaw	Item	Working Length (in.)	Length (in.)
FM720R	3.0	SHARP	COMPLETE	2 3/4	7 7/8
FM725R	3.0	SHARP	JAW INSERT	2 3/4	-
FM730R	-	-	HANDLE	-	-



XS Micro Tumor Grasping Forceps

Catalog Number	Jaw Size (mm)	Jaw	Item	Working Length (in.)	Length (in.)
FM721R	3.0	SHARP	COMPLETE	4	9
FM726R	3.0	SHARP	JAW INSERT	4	-
FM731R	-	-	HANDLE	-	-

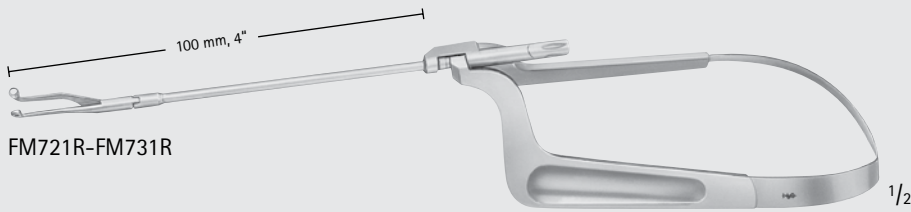

XS Micro Tumor Grasping Forceps

Catalog Number	Jaw Size (mm)	Jaw	Item	Working Length (in.)	Length (in.)
FM722R	3.0	SHARP	COMPLETE	5 1/8	10 1/4
FM727R	3.0	SHARP	JAW INSERT	5 1/8	-
FM732R	-	-	HANDLE	-	-

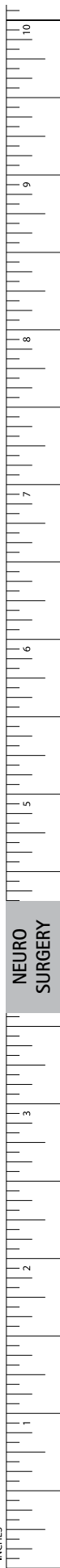
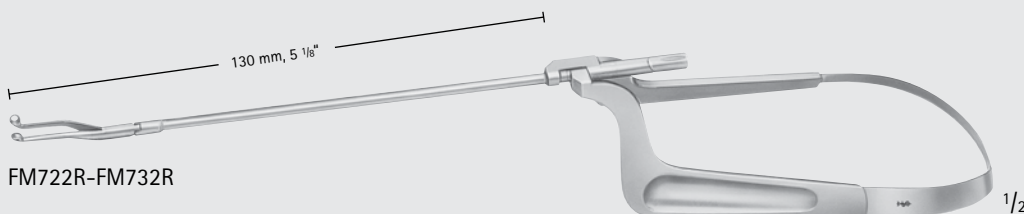

NEURO SURGERY

INCHES

Neurosurgery

XS Micro Forceps

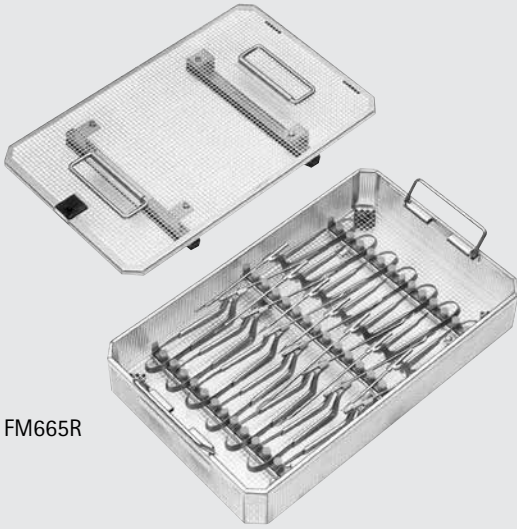

FM665R

Storage Tray for Micro Instruments, W/ Instruments Racks

Catalog Number	Compatible w/	Dimensions (mm)
FM665R	SENSATION AND XS MICRO- INSTRUMENTS	406 x 253 x 76

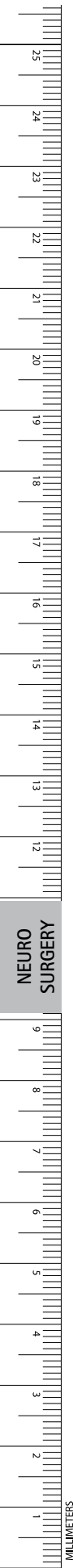

Neurosurgery

EC/IC Bypass Instruments - Noir™ Scissors

EC/IC Bypass Instruments, Noir Scissors

Catalog Number	Tip	Blade	Shape	Working Length (in.)	Length (in.)
FD482B	S/S	CVD	STR	2	5 1/2
FD481B	B/S	CVD	STR	2	5 1/2
FD483B	S/S	CVD	STR	3 1/8	6 3/4
FD484B	S/S	CVD	BAYONET	4	8 7/8
FD485B	B/S	CVD	BAYONET	4	8 7/8

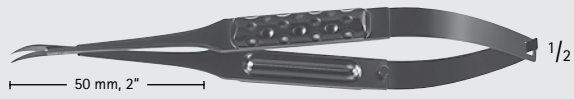

FD481B-FD482B



FD481B



FD482B

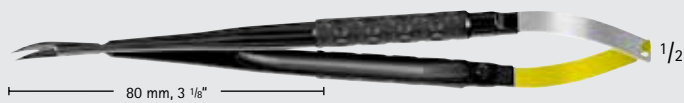

FD483B



FD483B

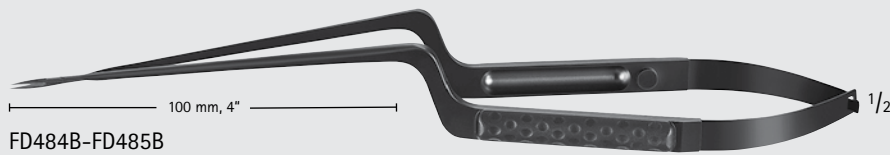

FD484B-FD485B



FD484B



FD485B



NEURO SURGERY

INCHES

Neurosurgery

EC/IC Bypass Instruments - Noir™ Forceps



FD488B



FD488B



FD489B



FD489B



FD490B



FD490B

EC/IC Bypass Instruments, Noir Forceps

Catalog Number	Tip	Tip Size (mm)	Working Length (in.)	Length (in.)
FD488B	STR	0.3	2	5 1/2
FD489B	STR	0.3	3 1/8	6 3/4
FD490B	STR	0.3	4	8 1/4

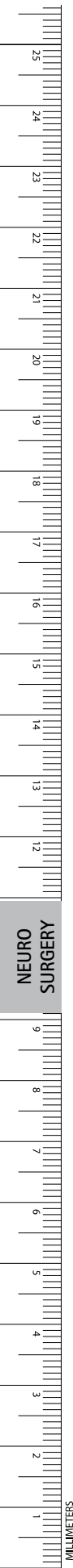

NEURO SURGERY

EC/IC Bypass Instruments - Noir™ Needle Holders/Noir™ Bypass Vessel Punch/Storage Rack

EC/IC Bypass Instruments, Noir Needle Holder

Catalog Number	Tip	Tip Size (mm)	Working Length (in.)	Length (in.)
FD493B	STR	0.5	2	6
FD494B	CVD	0.5	3 1/8	6 3/4
FD495B	CVD	0.5	4	8 1/4

EC/IC Bypass Instruments, Noir Bypass Vessel Punch

Catalog Number	Working Length (in.)	Length (in.)
FB194B	2	5 1/2

Storage Rack F/ EC/IC Bypass Instruments

Catalog Number	Dimensions (mm)
FD460R	410 x 257 x 56



NEURO SURGERY

INCHES

Neurosurgery

Skull Base Instruments

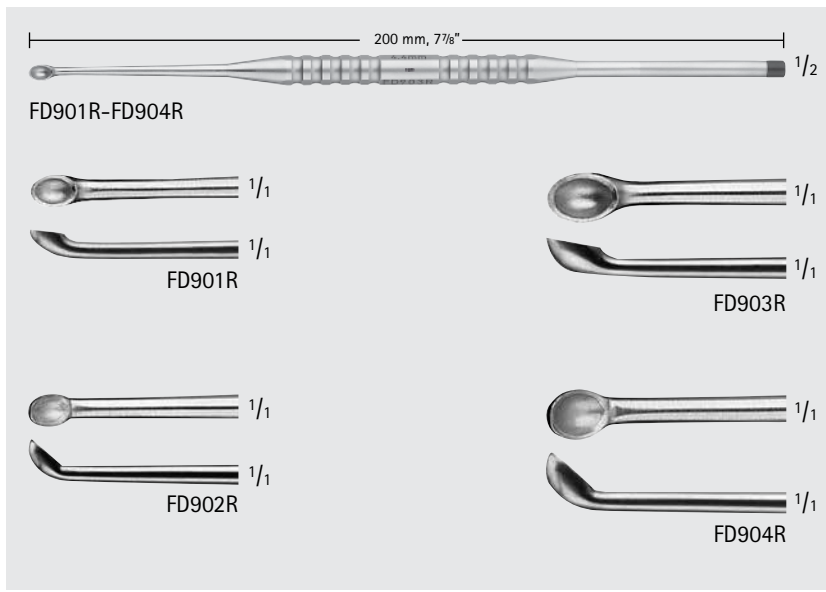
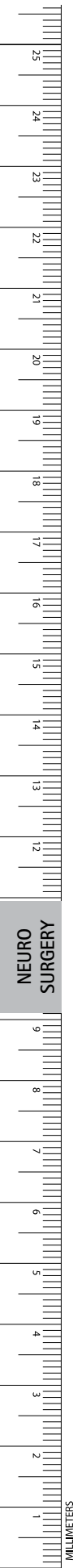

AL-MEFTY Spoon

Catalog Number	Tip	Tip Size (mm)	Handle	Length (in.)
FD901R	STR, SHARP	2.8	BLACK CAP	7 7/8
FD902R	ANG, SHARP	2.8	BLACK CAP	7 7/8
FD903R	STR, SHARP	4.4	BLACK CAP	7 7/8
FD904R	ANG, SHARP	4.4	BLACK CAP	7 7/8

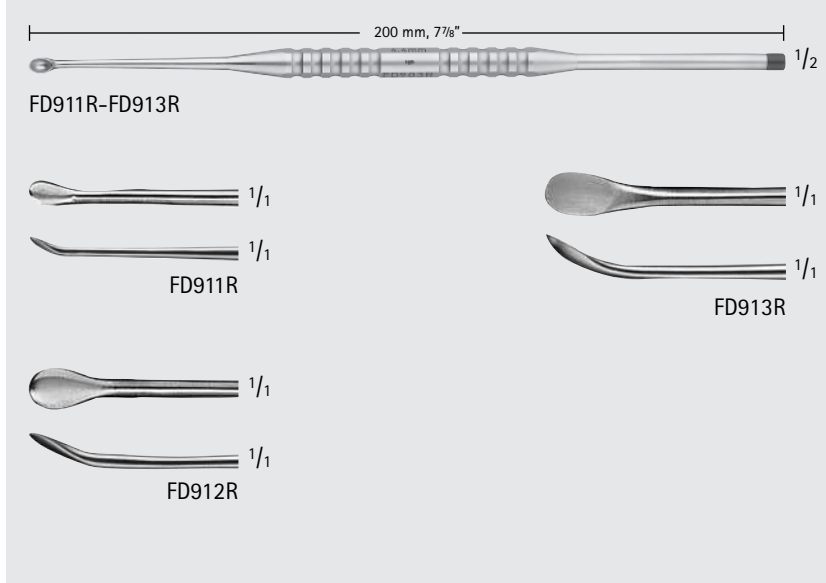

AL-MEFTY Dissector

Catalog Number	Tip	Tip Size (mm)	Handle	Length (in.)
FD911R	ANG, SHARP	2.0	BLACK CAP	7 7/8
FD912R	ANG, SHARP	3.5	BLACK CAP	7 7/8
FD913R	ANG, SHARP	4.0	BLACK CAP	7 7/8

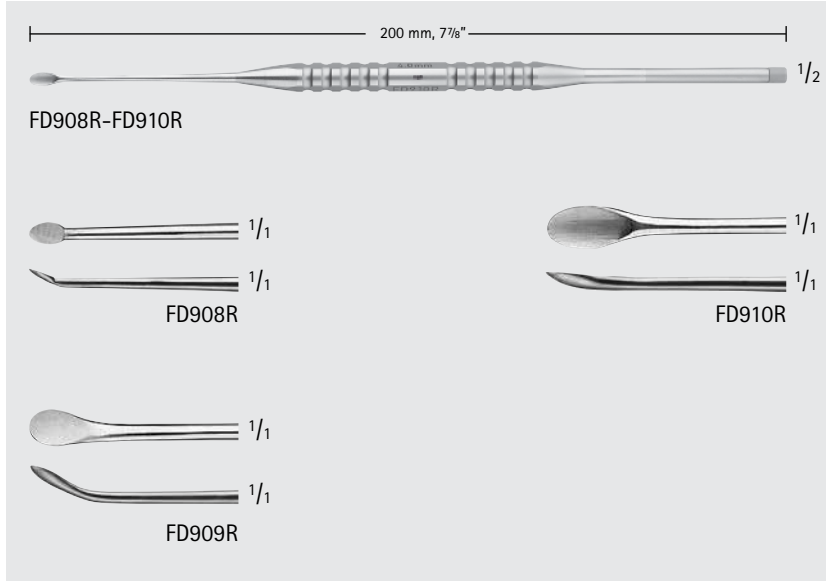

AL-MEFTY Dissector

Catalog Number	Tip	Tip Size (mm)	Handle	Length (in.)
FD908R	ANG, SEMI-SHARP	2.0	GREY CAP	7 7/8
FD909R	ANG, SEMI-SHARP	3.5	GREY CAP	7 7/8
FD910R	STR, SEMI-SHARP	4.0	GREY CAP	7 7/8



FD905R

AL-MEFTY Ligature Needle

Catalog Number	Tip	Length (in.)
FD905R	MALLEABLE	7 1/2

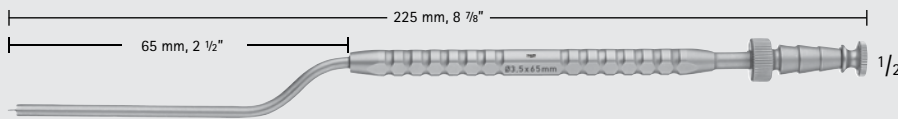

FD906R

AL-MEFTY Suction Cannula

Catalog Number	Working Length (in.)	Diameter (mm)	Length (in.)
FD906R	2 1/2	3.5	8 7/8

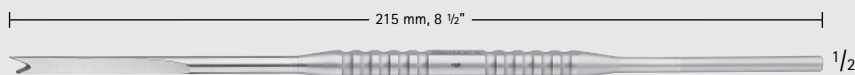

FD907R

AL-MEFTY Chisel

Catalog Number	Tip Size (mm)	Length (in.)
FD907R	5.0	8 1/2

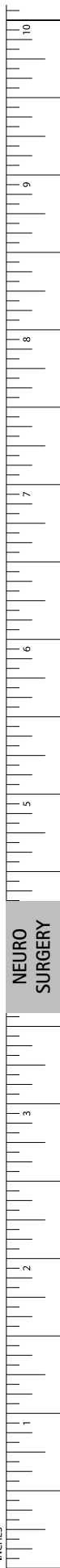

Neurosurgery

Micro Dissectors/Rasps/Hooks

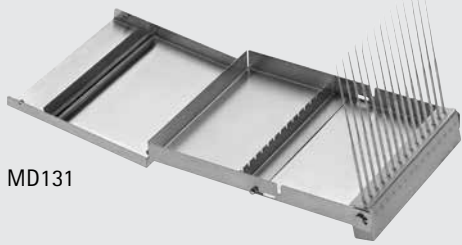

Micro Dissector Set

Catalog Number	Description
MD131	COMPLETE SET

Set Includes:

- 1 Micro dissector storage case MD132R
- 1 Instrument of each MD133-MD148



Micro Dissector Storage Case

Catalog Number	Dimension (in.)
MD132	10.869 x 8.115 x 0.944



Expanded Micro Dissector Storage Case

Catalog Number	Dimension (in.)
MF363R	10.869 x 10.074 x 0.944



Expanded Micro Dissector Set

Catalog Number	Description
MF364R	COMPLETE SET

Set Includes:

- 1 Expanded micro dissector storage case MF363R
- 1 Instrument of each MD133-MD148, MF360R-MF362R

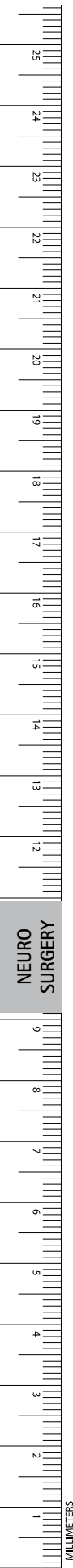

Neurosurgery

Micro Dissectors/Rasps/Hooks



MD133 1/2

1/1

1/1

MD133

Micro Dissector, Round

Catalog Number	Tip Size (mm)	Length (in.)
MD133	1.0	7 1/2

MD134 1/2

1/1

1/1

MD134

Micro Dissector, Round

Catalog Number	Tip Size (mm)	Length (in.)
MD134	2.0	7 1/2

MD135 1/2

1/1

1/1

MD135

Micro Dissector, Round

Catalog Number	Tip Size (mm)	Length (in.)
MD135	3.0	7 1/2

MD136 1/2

1/1

1/1

MD136

Micro Elevator

Catalog Number	Tip	Length (in.)
MD136	CVD	7 1/2

MD137 1/2

1/1

1/1

MD137

Micro Dissector Elevator

Catalog Number	Tip	Length (in.)
MD137	ANG	7 1/2

MD138 1/2

1/1

1/1

MD138

Micro Spatula Dissector

Catalog Number	Tip	Length (in.)
MD138	SMALL	7 1/2

Neurosurgery

Micro Dissectors/Rasps/Hooks

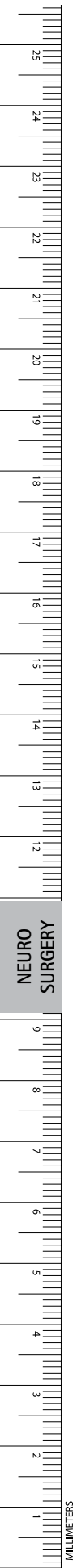

MD139 1/2

MD139 1/1

MD139 1/1

MD139

Micro Spatula Dissector

Catalog Number	Tip	Length (in.)
MD139	MEDIUM	7 1/2

MD140 1/2

MD140 1/1

MD140 1/1

MD140

Micro Spatula Dissector

Catalog Number	Tip	Length (in.)
MD140	LARGE	7 1/2

MD141 1/2

MD141 1/1

MD141

Micro Hook

Catalog Number	Tip	Length (in.)
MD141	90°, SEMI-SHARP	7 1/2

MD142 1/2

MD142 1/1

MD142

Micro Hook

Catalog Number	Tip	Length (in.)
MD142	90°, BLUNT	7 1/2

MD143 1/2

MD143 1/1

MD143

Micro Needle Dissector

Catalog Number	Tip	Length (in.)
MD143	45°, SEMI-SHARP	7 1/2

MD144 1/2

MD144 1/1

MD144

Micro Needle Dissector

Catalog Number	Tip	Length (in.)
MD144	STR, SEMI-SHARP	7 1/2

Neurosurgery

Micro Dissectors/Rasps/Hooks





MD145 1/2



MD145 1/1

Micro Curette

Catalog Number	Tip	Tip Size (mm)	Length (in.)
MD145	STR	1 x 2	7 1/2



MD146 1/2



MD146 1/1

Micro Curette

Catalog Number	Tip	Tip Size (mm)	Length (in.)
MD146	ANG	1 x 2	7 1/2



MD147 1/2



MD147 1/1

Micro Ball Dissector

Catalog Number	Tip	Tip Size (mm)	Length (in.)
MD147	90°	3.0	7 1/2



MD148 1/2

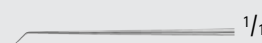

MD148 1/1

Micro Ball Dissector

Catalog Number	Tip	Tip Size (mm)	Length (in.)
MD148	45°	4.0	7 1/2

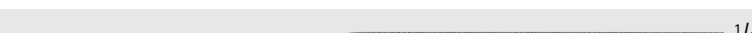

MF360R 1/2

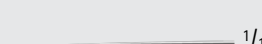

MF360R 1/1

Micro Ball Dissector

Catalog Number	Tip	Tip Size (mm)	Length (in.)
MF360R	90°	5.0	7 1/2

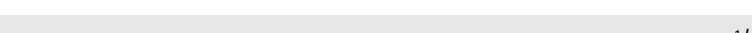

MF361R 1/2

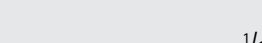

MF361R 1/1

Micro Ball Dissector

Catalog Number	Tip	Tip Size (mm)	Length (in.)
MF361R	45°	8.0	7 1/2

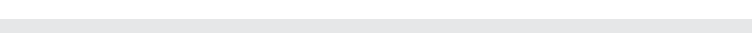

MF362R 1/2

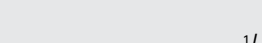

MF362R 1/1

Micro Ball Dissector

Catalog Number	Tip	Tip Size (mm)	Length (in.)
MF362R	STR	0.8	7 1/2

INCHES

Neurosurgery

Micro Dissectors/Rasps/Hooks

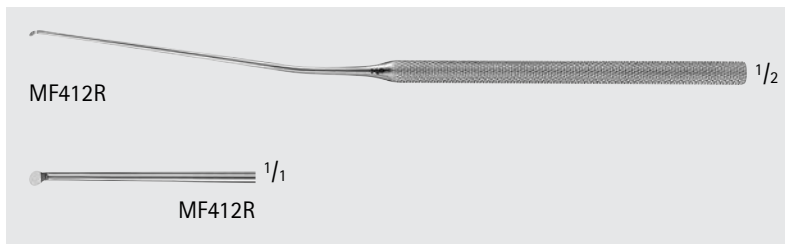
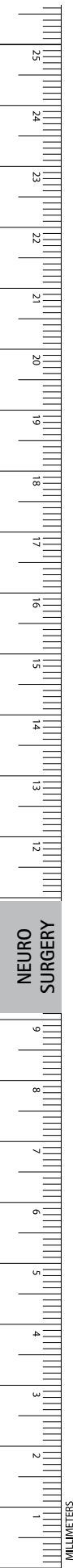

Jannetta Style Knife #1

Catalog Number	Diameter (mm)	Length (in.)
MF412R	2.0	7 1/2

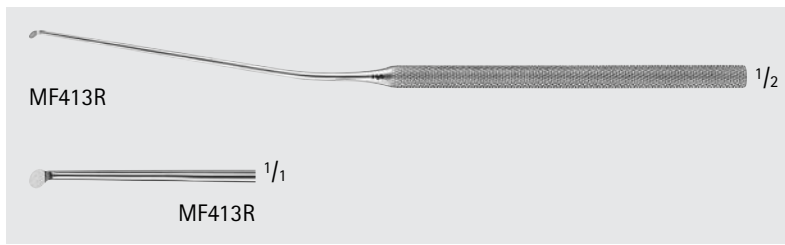

Jannetta Style Knife #2

Catalog Number	Diameter (mm)	Length (in.)
MF413R	2.5	7 1/2

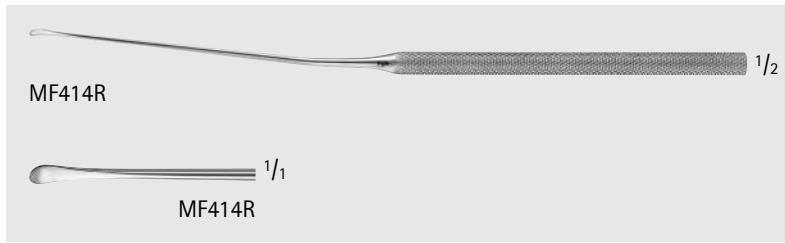

Jannetta Style Duckbill Elevator #3

Catalog Number	Width (mm)	Length (in.)
MF414R	2.7	7 1/2

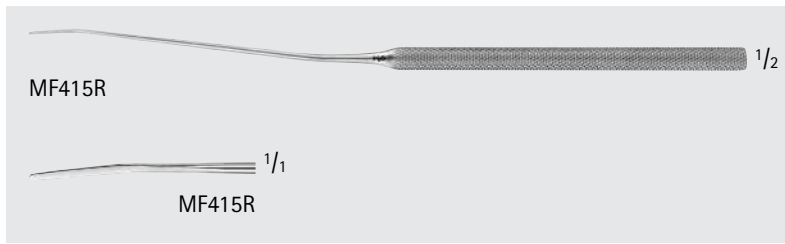

Jannetta Style Elevator #4

Catalog Number	Width (mm)	Length (in.)
MF415R	1.2	7 1/2

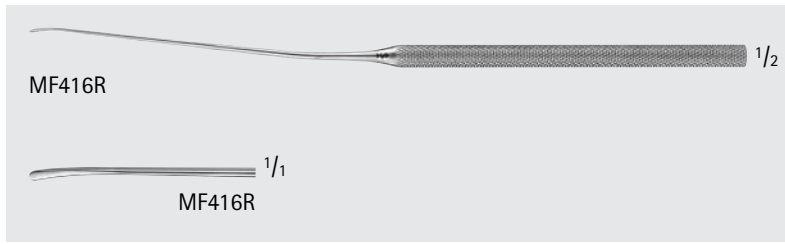

Jannetta Style Dissector #5

Catalog Number	Width (mm)	Length (in.)
MF416R	1.6	7 1/2

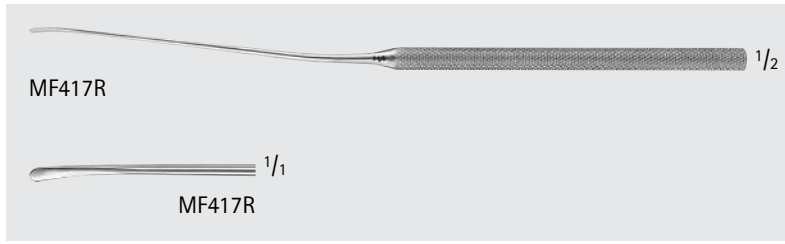

Jannetta Style Dissector #6

Catalog Number	Width (mm)	Length (in.)
MF417R	2.0	7 1/2

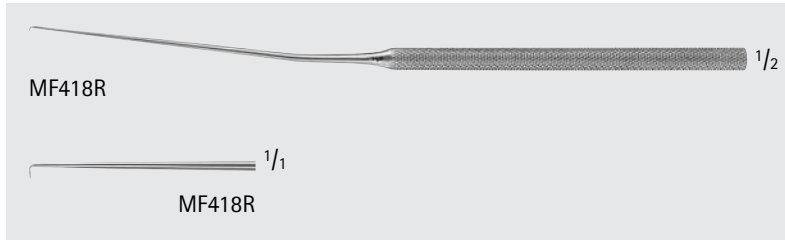

Jannetta Style Right Angle Hook #7

Catalog Number	Tip	Tip Size (mm)	Length (in.)
MF418R	90°	2.0	7 1/2

Neurosurgery

Micro Dissectors/Rasps/Hooks





MF419R 1/2

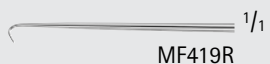

MF419R 1/1

Jannetta Style Probe #8

Catalog Number	Tip	Tip Size (mm)	Length (in.)
MF419R	45°	1.7	7 1/2



MF420R 1/2

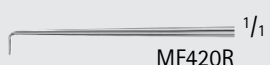

MF420R 1/1

Jannetta Style Right Angle Hook #9

Catalog Number	Tip	Tip Size (mm)	Length (in.)
MF420R	90°	3.5	7 1/2



MF421R 1/2



MF421R 1/1

Jannetta Style Hook #9A

Catalog Number	Tip	Tip Size (mm)	Length (in.)
MF421R	45°	2.8	7 1/2



MF422R 1/2



MF422R 1/1

Jannetta Style Right Angle Hook #10

Catalog Number	Tip	Tip Size (mm)	Length (in.)
MF422R	90°	4.7	7 1/2



MF423R 1/2

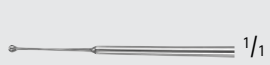

MF423R 1/1

Jannetta Style Probe #11

Catalog Number	Tip	Diameter (mm)	Length (in.)
MF423R	BALL-PT	0.8	7 1/2



MF424R 1/2



MF424R 1/1

Jannetta Style Double Prong Fork #12

Catalog Number	Tip	Width (mm)	Length (in.)
MF424R	30°	1.1	7 1/2



MF425R 1/2

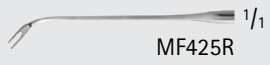

MF425R 1/1

Jannetta Style Double Prong Fork #13

Catalog Number	Tip	Width (mm)	Length (in.)
MF425R	30°	1.4	7 1/2

INCHES

Neurosurgery

Micro Dissectors/Rasps/Hooks

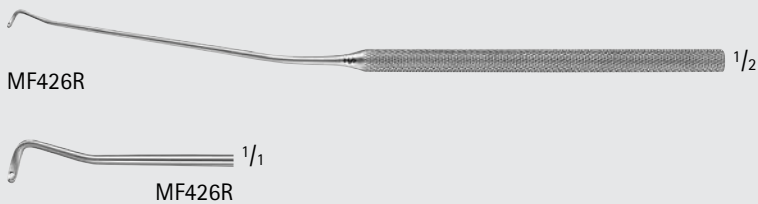

Jannetta Style Aneurysm Neck Dissector #14

Catalog Number	Tip	Length (in.)
MF426R	RIGHT	7 1/2

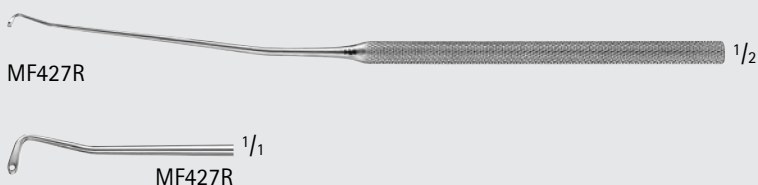

Jannetta Style Aneurysm Neck Dissector #15

Catalog Number	Tip	Length (in.)
MF427R	RIGHT	7 1/2

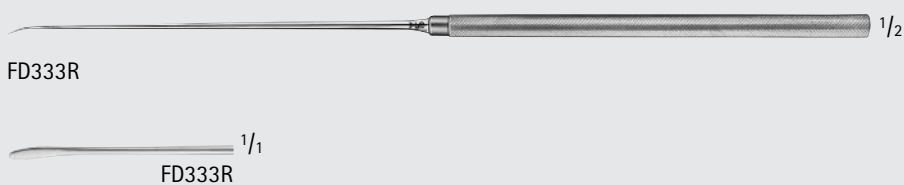

Micro Dissector

Catalog Number	Length (in.)
FD333R	9

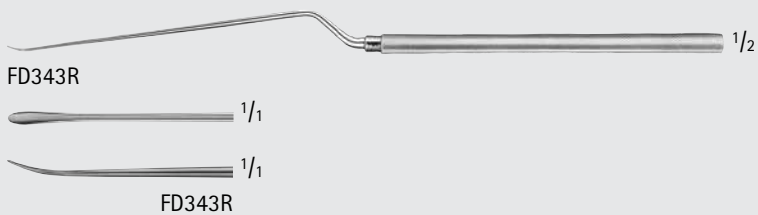

Micro Dissector

Catalog Number	Tip	Shape	Length (in.)
FD343R	CVD-UP	BAYONET	9

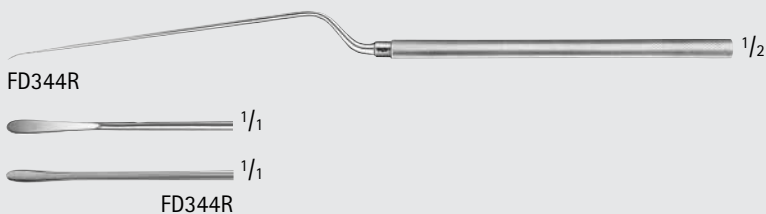

Micro Dissector

Catalog Number	Tip	Shape	Length (in.)
FD344R	CVD	BAYONET	9



Micro Raspatory

Catalog Number	Tip	Length (in.)
FD338R	PLATE-SHAPED ANG-DOWN	9

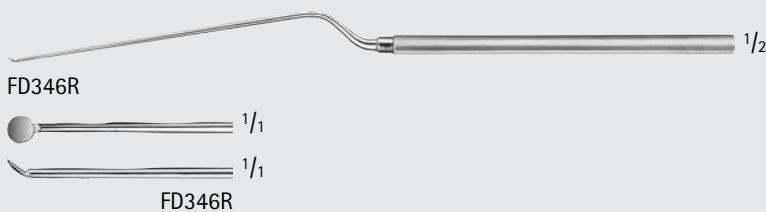

Micro Raspatory

Catalog Number	Tip	Shape	Length (in.)
FD346R	PLATE-SHAPED ANG-UP	BAYONET	9



NEURO SURGERY

Neurosurgery

Micro Dissectors/Rasps/Hooks

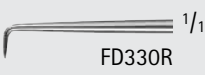

FD330R 1/2 **Micro Hook**

Catalog Number	Tip	Length (in.)
FD330R	SEMI-SHARP	9

FD331R 1/2 **Micro Hook**

Catalog Number	Tip	Length (in.)
FD331R	BLUNT	9

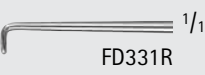
FD332R 1/2 **Micro Dissector**

Catalog Number	Tip	Length (in.)
FD332R	STR	9

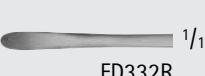
FD334R 1/2 **Micro Dissector**





Catalog Number	Tip	Length (in.)
FD334R	SMALL	9

FD335R 1/2 **Micro Scoop**



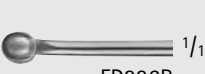

Catalog Number	Tip	Length (in.)
FD335R	STR, SHARP	9

FD336R 1/2 **Micro Scoop**

Catalog Number	Tip	Length (in.)
FD336R	ANG, SHARP	9

FD337R 1/2 **Micro Raspatory**

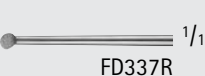
Catalog Number	Tip	Length (in.)
FD337R	ROUND, SMALL	9

NEURO SURGERY

INCHES

Neurosurgery

Micro Dissectors/Rasps/Hooks



FF326R

YASARGIL Dissector, F/ Pediatrics

Catalog Number	Tip Size (mm)	Shaft	Length (in.)
FF326R	4.0	FLEX	7 3/4



FF327R

YASARGIL Dissector, F/ Adults

Catalog Number	Tip Size (mm)	Shaft	Length (in.)
FF327R	7.0	FLEX	7 3/4



FF291R

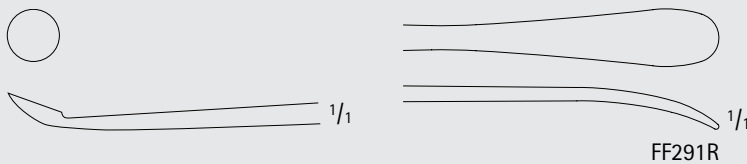

PENFIELD Dissector, Double Ended

Catalog Number	Tip	Size	Length (in.)
FF291R	SLIGHT-CVD, S/B	#1	6 7/8



FF292R



PENFIELD Dissector, Double Ended

Catalog Number	Tip	Size	Length (in.)
FF292R	SLIGHT-CVD, S/B	#2	7 3/4



FF293R

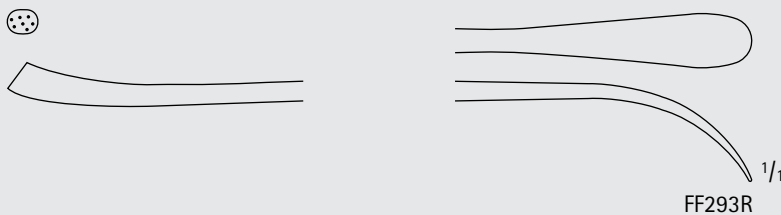

PENFIELD Dissector, Double Ended

Catalog Number	Tip	Size	Length (in.)
FF293R	CVD, S/B	#3	7 3/4



FF294R

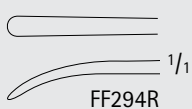

PENFIELD Dissector

Catalog Number	Tip	Size	Length (in.)
FF294R	SLIGHT-CVD	#4	8



NEURO SURGERY

PENFIELD Dissector, Double Ended

Catalog Number	Tip	Size	Length (in.)
FF295R	SLIGHT-CVD, B/B	#5	11 1/2

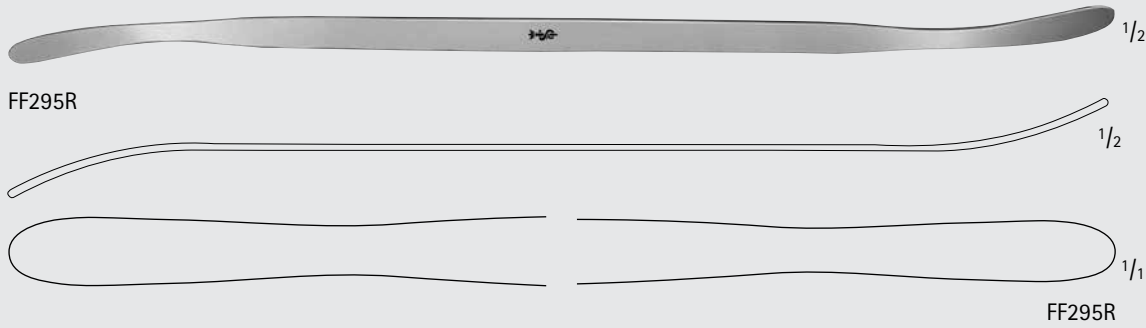

CASPAR Micro Dissector

Catalog Number	Tip	Tip Size (mm)	Length (in.)
FF310R	CVD	1.0	7 7/8
FF303R	CVD	4.5	9

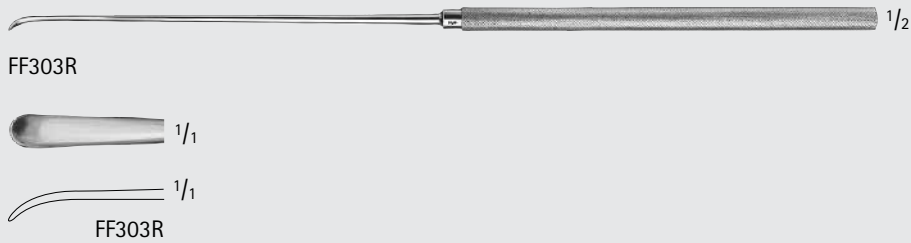

CASPAR Micro Dissector

Catalog Number	Tip	Tip Size (mm)	Shape	Length (in.)
FF307R	CVD-DOWN	2.0	BAYONET	9
FF305R	CVD-DOWN	4.5	BAYONET	9

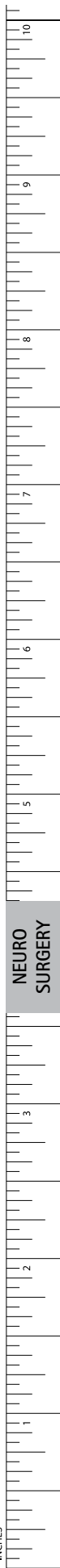
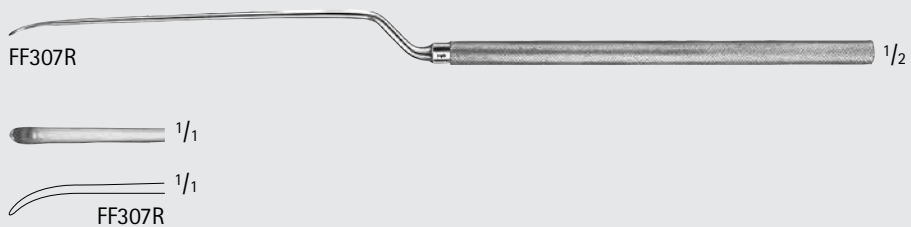
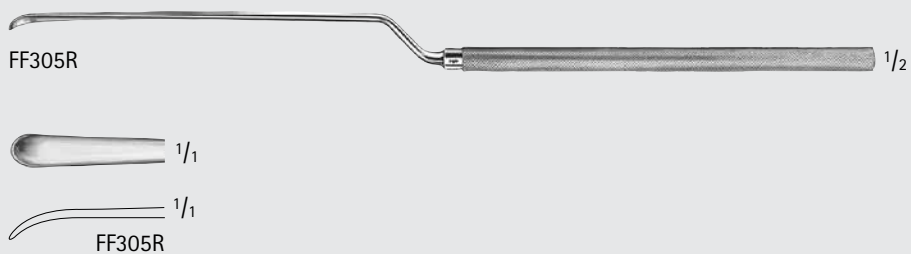

NEURO SURGERY

INCHES

Neurosurgery

Micro Dissectors/Rasps/Hooks

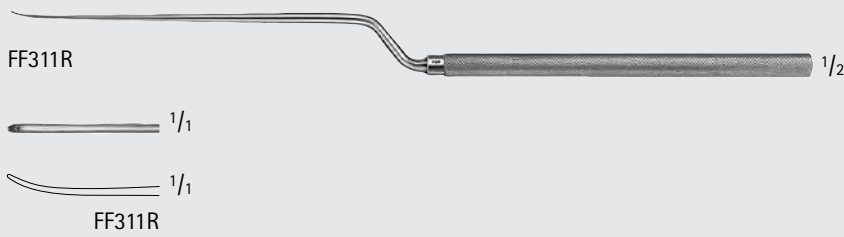

CASPAR Micro Dissector

Catalog Number	Tip	Tip Size (mm)	Shape	Length (in.)
FF311R	CVD-UP	1.0	BAYONET	8 1/4
FF312R	CVD-DOWN	1.0	BAYONET	8 1/4

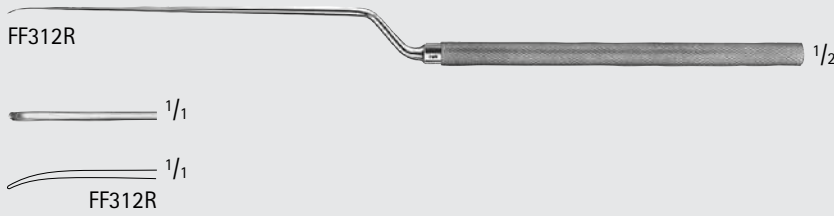

MILLIGAN Dissector, Double Ended



Catalog Number	Tip	Tip Size (mm)	Length (in.)
MF455R	S/B	7.8	8 3/4

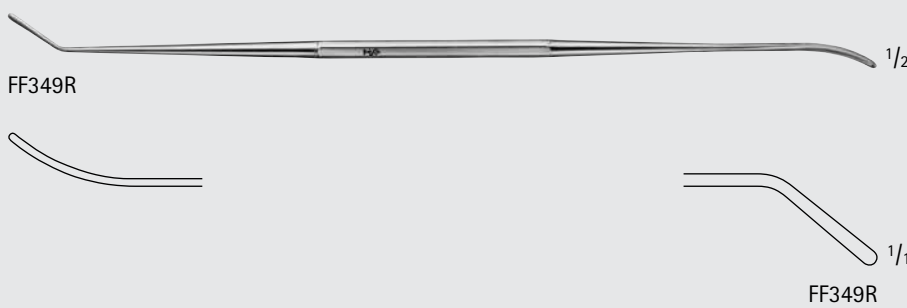

PENNYBACKER Probe Dissector, Double Ended

Catalog Number	Tip	Length (in.)
FF349R	SLIGHT-CVD	9

NEURO SURGERY

WOODSON Elevator, Spatula, Double Ended

Catalog Number	Tip	Length (in.)
MD605	DBL-END	10



DAVIS Vascular Spatula, Double Ended

Catalog Number	Tip	Length (in.)
FF300R	SLIGHT-CVD, B/B	9 5/8



TOENNIS Vascular Spatula, Double Ended

Catalog Number	Tip	Tip Size (mm)	Length (in.)
FF301R	SLIGHT-CVD, B/B	3 + 4	9 1/2
FF302R	SLIGHT-CVD, B/B	5 + 6	9 1/2

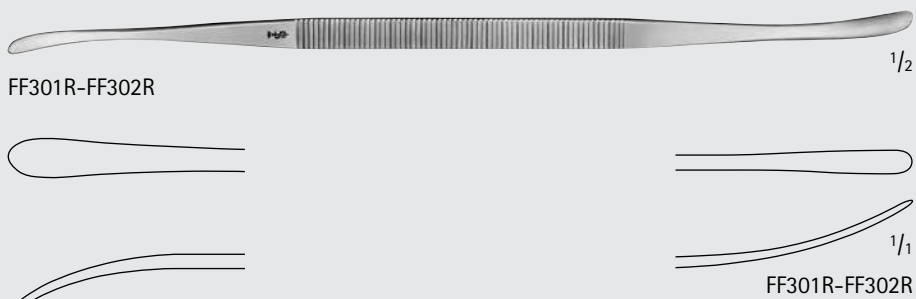

MUELLER Dura Hook

Catalog Number	Tip	Length (in.)
OL626R	1 PRONG	6

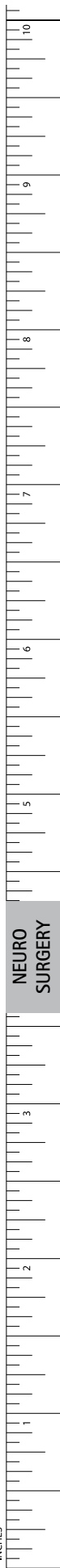
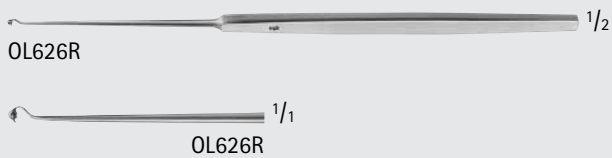

NEURO SURGERY

INCHES

Neurosurgery

Micro Dissectors/Rasps/Hooks



OL627R

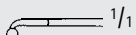

OL627R

MUELLER Dura Hook

Catalog Number	Tip	Length (in.)
OL627R	2 PRONGS	6



FF313R



FF313R

CAIRNS Dura Retractor

Catalog Number	Tip	Length (in.)
FF313R	ANG SHARP	5 1/8



FF321R



FF321R

FRAZIER Dura Retractor

Catalog Number	Tip	Length (in.)
FF321R	CVD SHARP	5 1/8



FF322R



FF322R

TOENNIS Dura Retractor

Catalog Number	Tip	Length (in.)
FF322R	CVD SHARP	6



FL711R

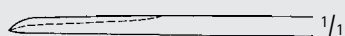

FL711R

KRAEMER Osteophyte Chisel

Catalog Number	Tip Size (mm)	Length (in.)
FL711R	2.5	8 1/2

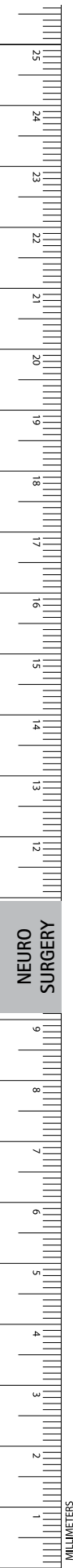

NEURO SURGERY

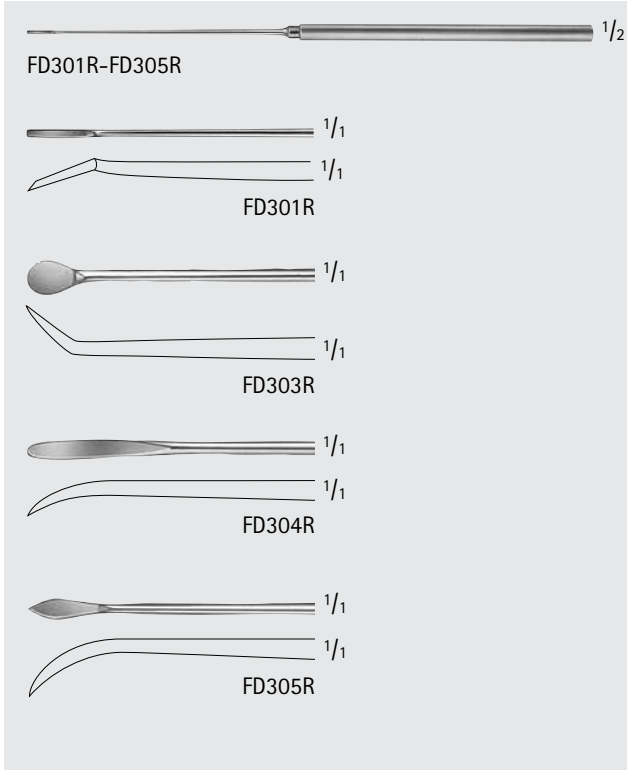
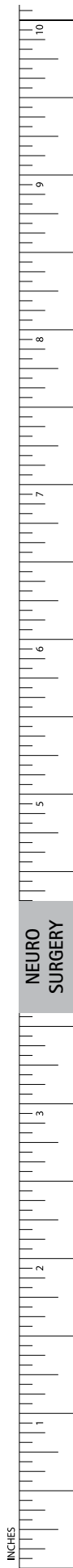

YASARGIL Micro Raspatory

Catalog Number	Tip	Shape	Length (in.)
FD301R	ANG-UP	STR	7 1/4
FD303R	ANG-UP	STR	7 1/4
FD304R	SLIGHT-CVD	STR	7 1/4
FD305R	HEAVY-CVD	STR	7 1/4

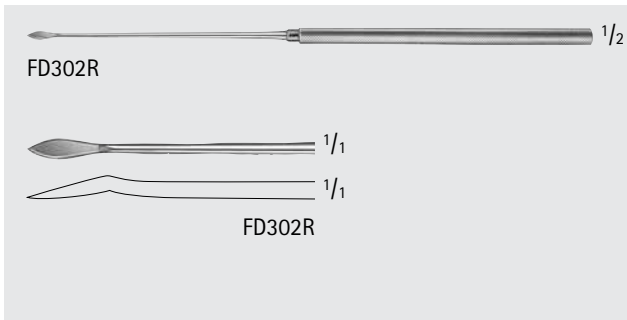

YASARGIL Micro Dissector

Catalog Number	Tip	Shape	Length (in.)
FD302R	ANG-UP	STR	7 1/4

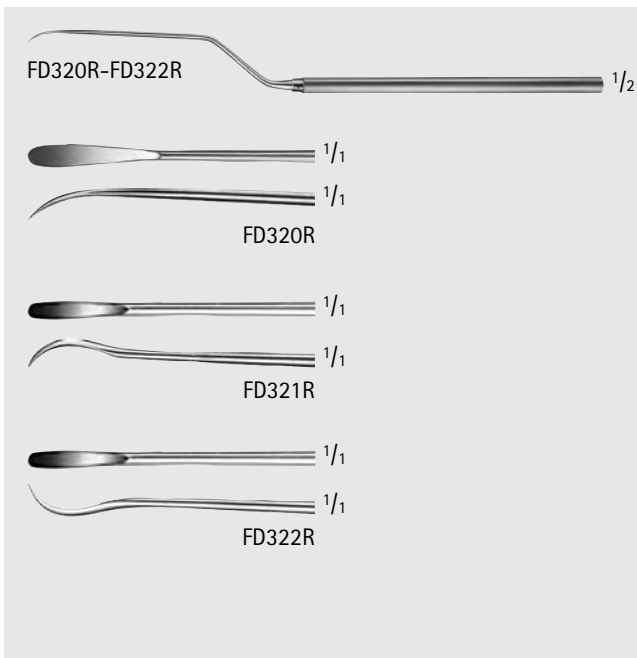

YASARGIL Micro Raspatory

Catalog Number	Tip	Shape	Length (in.)
FD320R	CVD	BAYONET	7 1/4
FD321R	CVD	BAYONET	7 1/4
FD322R	CVD-UP	BAYONET	7 1/4

Neurosurgery

Micro Dissectors/Rasps/Hooks



Twist Hook Tissue Pick

Catalog Number	Tip	Length (in.)
FD392R	1.8	7 1/4



FISCH Hook, Sharp

Catalog Number	Tip	Length (in.)
FD376R	90°	7 1/4



Dura Hook, Sharp

Catalog Number	Tip	Length (in.)
FD375R	90°	7 1/4

CASPAR Exploration Hook, Probe-End

Catalog Number	Tip	Length (in.)
BT088R	90° SHORT	9 5/8
BT089R	90° MEDIUM	9 5/8
BT090R	90° LONG	9 5/8
BT091R	45°	9 5/8

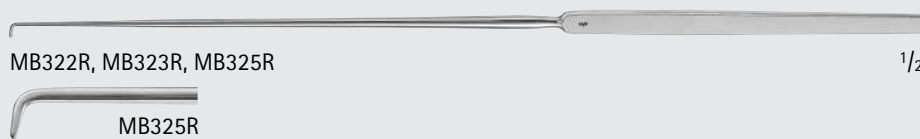
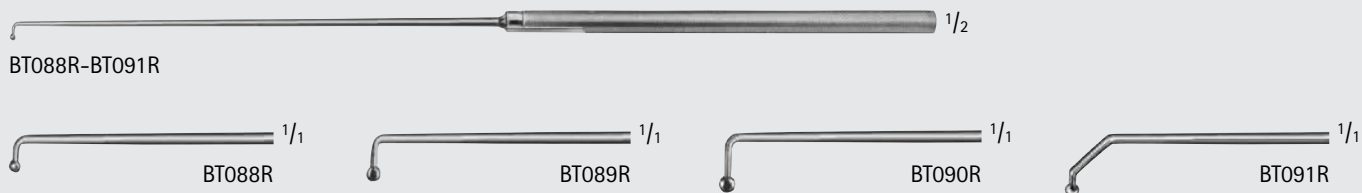

MCCULLOCH Probe

Catalog Number	Tip	Tip Size (mm)	Length (in.)
MB310R	-	COMPLETE SET	-
MB322R	ANG HOOK	2	9 1/2
MB323R	ANG HOOK	3	9 1/2
MB325R	ANG HOOK	5	9 1/2
MB328R	ANG BALL	4	9 1/2
MB335R	ANG BALL	7	9 1/2
MB320R	ANG BALL	8	9 1/2
MB326R	FORAMINAL	17	9 1/2

MB310R Includes:
1 Probe of each MB320R, MB322R, MB323R, MB325R, MB326R

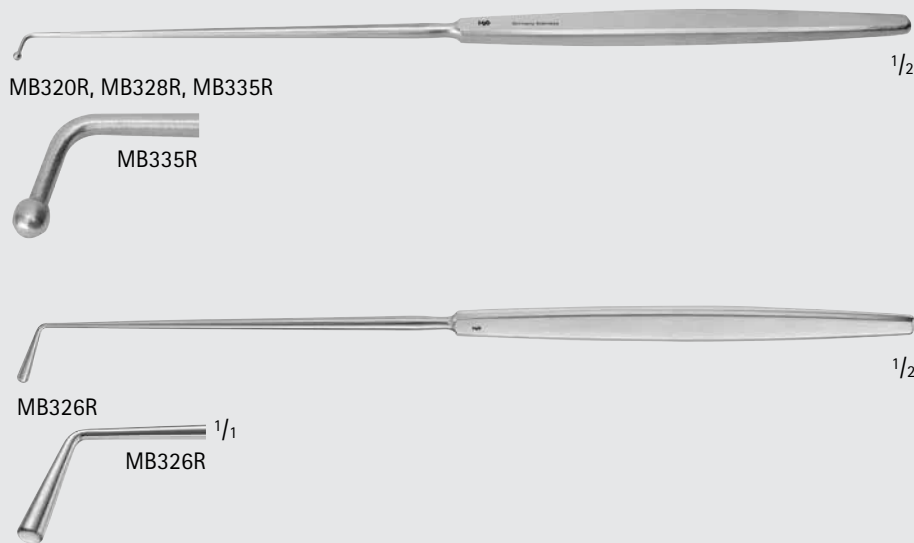

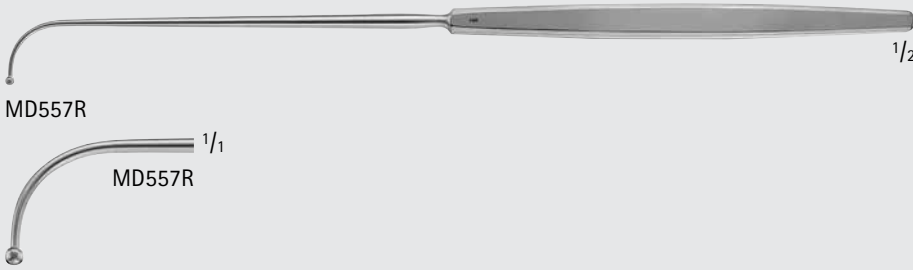

MURPHY Ball Hook

Catalog Number	Tip	Length (in.)
MD557R	HEAVY-CVD	9 1/4

MD557R ^{1/2}
MD557R ^{1/1}

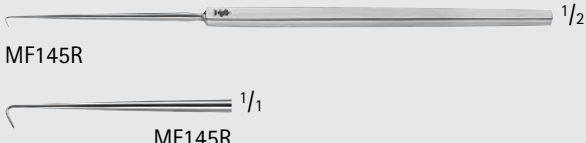

CUSHING Dura Hook

Catalog Number	Length (in.)
MF145R	5 3/4

MF145R ^{1/2}
MF145R ^{1/1}

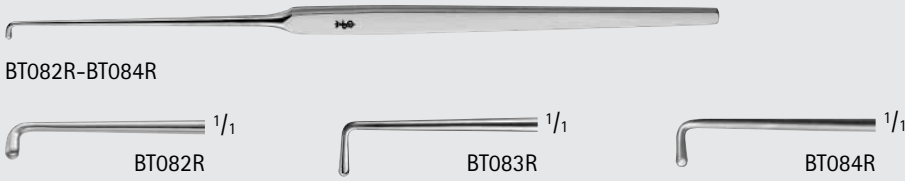

CUSHING Vessel Hook

Catalog Number	Tip Size (mm)	Tip	Length (in.)
BT082R	1 x 4	BLUNT	7 1/2
BT083R	1 x 7	BLUNT	7 1/2
BT084R	1 x 6	BLUNT	11

BT082R-BT084R
BT082R ^{1/1} BT083R ^{1/1} BT084R ^{1/1}



CRILE Vessel Hook

Catalog Number	Tip Size (mm)	Tip	Length (in.)
BT080R	1.5 x 9	BLUNT	7 7/8

BT080R ^{1/2}
BT080R ^{1/1}



MALIS Style Nerve Hook

Catalog Number	Tip	Tip Size (mm)	Length (in.)
MF143R	BLUNT	2.0	7
MF144R	BLUNT	3.0	7
MF142R	BALL-POINT	3.0	7

MF142R-MF144R ^{1/2}
MF142R-MF144R ^{1/1}

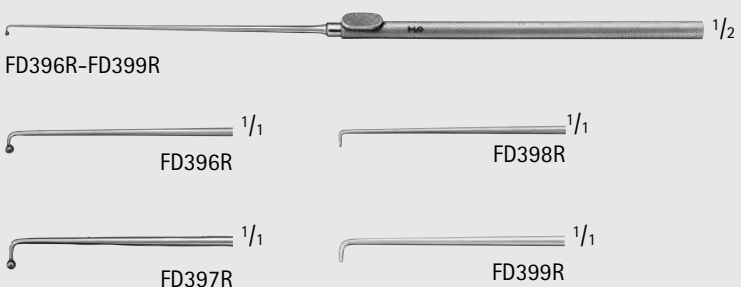

KRAYENBUEHL Nerve Hook

Catalog Number	Tip	Length (in.)
FD396R	SHORT BALL-POINT	7 1/4
FD397R	BALL-POINT	7 1/4
FD398R	BLUNT	7 1/4
FD399R	BLUNT	7 1/4

FD396R-FD399R ^{1/2}
FD396R ^{1/1} FD398R ^{1/1}
FD397R ^{1/1} FD399R ^{1/1}



Neurosurgery

Micro Dissectors/Rasps/Hooks



DANDY Nerve Hook

Catalog Number	Tip Size (mm)	Blade End	Length (in.)
MD562	1 x 8	BLUNT	8 3/4



WEARY Nerve Hook

Catalog Number	Color	Length (in.)
MF138R	BLACK	8

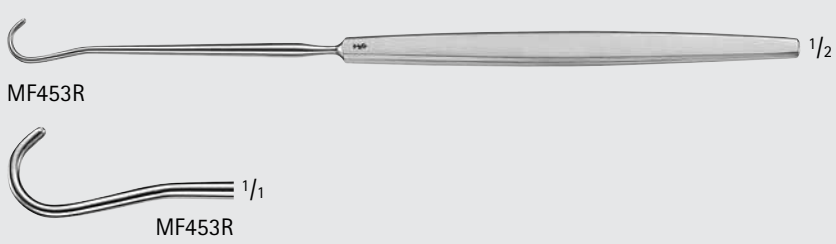

SMITHWICK Nerve Hook

Catalog Number	Length (in.)
MF453R	8 1/4

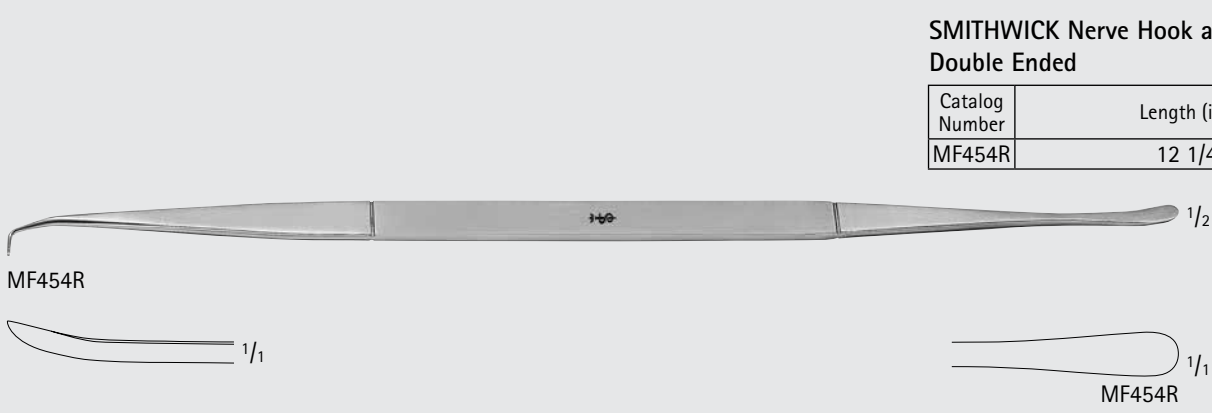

SMITHWICK Nerve Hook and Dissector, Double Ended

Catalog Number	Length (in.)
MF454R	12 1/4

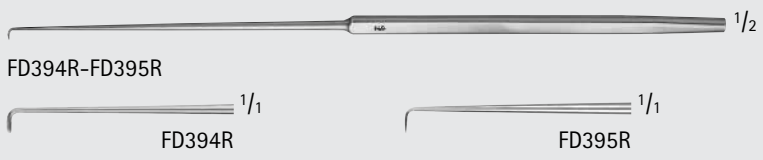

ADSON Nerve Hook

Catalog Number	Tip	Length (in.)
FD394R	BLUNT	7 1/2
FD395R	SHARP	7 1/2



NEURO SURGERY



FD270R-FD273R



FD270R



FD272R



FD271R

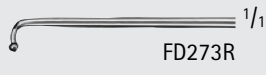

FD273R

YASARGIL Ligature Guide, W/ Ball Point

Catalog Number	Tip	Length (in.)
FD270R	CVD-LEFT	7 1/4
FD271R	CVD	7 1/4
FD272R	HEAVY-CVD	7 1/4
FD273R	90°	7 1/4



FD262R

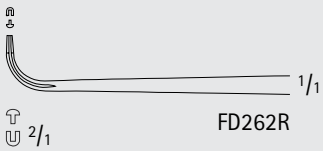

FD262R



YASARGIL Ligature Forceps

Catalog Number	Tip	Shape	Length (in.)
FD262R	TOOTHED	BAYONET	7



FF309



FF309

CASPAR Suture Pusher

Catalog Number	Shape	Length (in.)
FF309	BAYONET	9

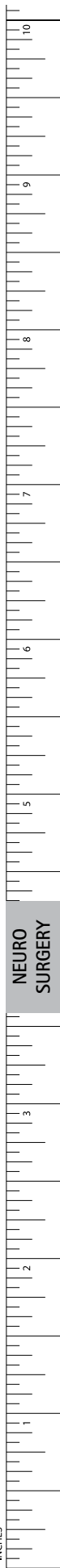

NEURO SURGERY

INCHES

Neurosurgery

Dural Separators and Knives

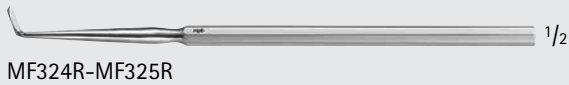

HOEN Dural Separator

Catalog Number	Tip	Depth (mm)	Width (mm)	Length (in.)
MF324R	90°	15	3.0	5 1/2
MF325R	45°	15	3.0	6

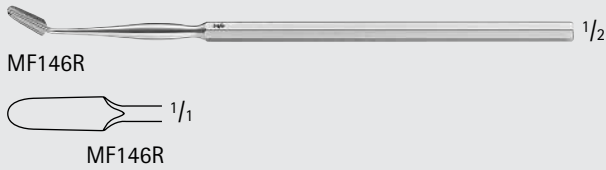

DORSEY Dural Separator

Catalog Number	Depth (mm)	Width (mm)	Length (in.)
MF146R	15	5.0	6



FRAZIER Dural Separator

Catalog Number	Depth (mm)	Width (mm)	Length (in.)
MF147R	13	3.0	6

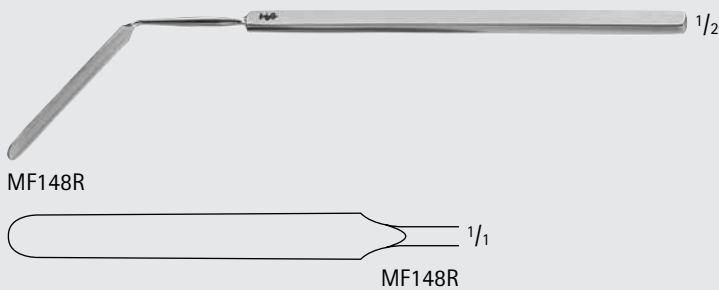

HORSLEY Dural Separator

Catalog Number	Depth (mm)	Width (mm)	Length (in.)
MF148R	55	6.5	8 1/4

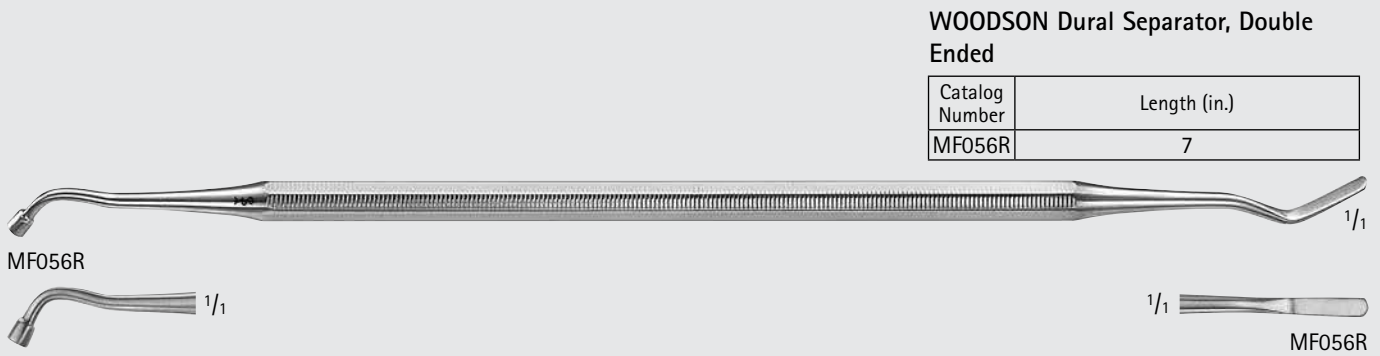

WOODSON Dural Separator, Double Ended

Catalog Number	Length (in.)
MF056R	7

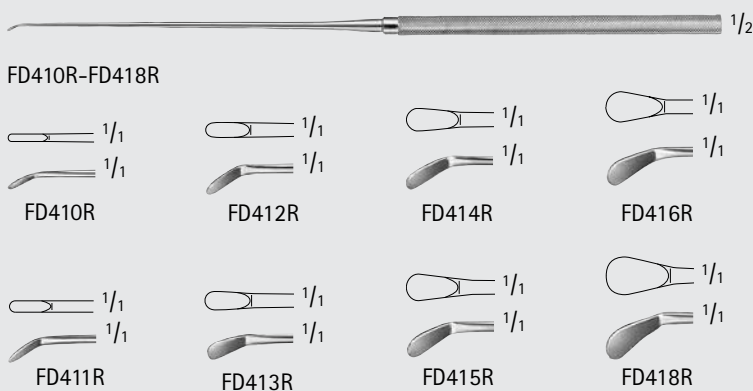

SAMII Knives for Tumor Tissue

Catalog Number	Tip Size (mm)	Length (in.)
FD410R	1.0	9
FD411R	1.5	9
FD412R	2.0	9
FD413R	2.5	9
FD414R	3.0	9
FD415R	3.5	9
FD416R	4.0	9
FD418R	5.0	9

NEURO SURGERY

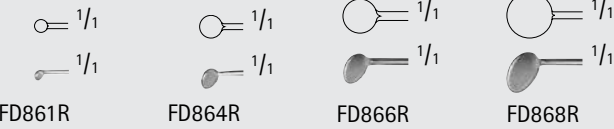

SAMII Tumor Tissue Knife, Round Blade

Catalog Number	Diameter (mm)	Length (in.)
FD861R	1.5	9
FD864R	3.0	9
FD866R	4.5	9
FD868R	6.0	9

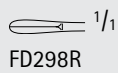

SAMII Lancet Knife

Catalog Number	Length (in.)
FD298R	9



CASPAR Micro Knife

Catalog Number	Tip	Shape	Length (in.)
FD347R	BLUNT	STR	7 7/8



KOOS Micro Vessel Knife, Bayonet-Shaped

Catalog Number	Tip	Length (in.)
FD351R	CVD-UP	7 1/4
FD352R	CVD-DOWN	7 1/4
FD353R	SLIGHT CVD-UP	7 1/4
FD354R	SLIGHT CVD-DOWN	7 1/4
FD365R	STRONG CVD-DOWN	7 1/4
FD366R	STRONG CVD-UP	7 1/4

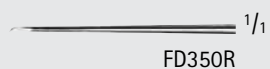

JACOBSON Vessel Knife

Catalog Number	Length (in.)
FD350R	7 1/4

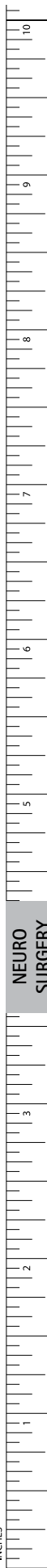

NEURO SURGERY

INCHES

Neurosurgery

Knives

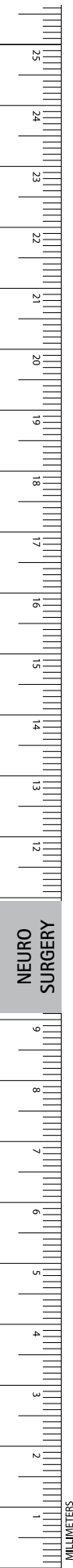

FD113D 1/2

FD113D 1/1

Catalog Number	Tip	Blade	Handle Color	Length (in.)
FD113D	7 FACETS	ROUND	GOLD	8

FD114D 1/2

FD114D 1/1

Catalog Number	Tip	Blade	Handle Color	Length (in.)
FD114D	60°	RETRO	COPPER	8

FD115D 1/2

FD115D 1/1

Catalog Number	Tip	Blade	Handle Color	Length (in.)
FD115D	45°	WEDGE	BLACK	8

FD116D 1/2

FD116D 1/1

Catalog Number	Tip	Blade	Handle Color	Length (in.)
FD116D	60°	LANCET	BRONZE	8



OK100R-OK102R

CUSHING-LANDOLT Transsphenoidal Speculum

Catalog Number	Blade Size (mm)	Length (in.)
OK100R	70 x 15	-
OK101R	90 x 15	-
OK102R	110 x 15	-
OK103R	SPREADER FOR OK100R-OK102R	8 1/4



OK103R



MF130R-MF132R

KILLIAN Speculum, Self Retaining

Catalog Number	Blade Size (mm)
MF130R	51 x 7
MF131R	76 x 7
MF132R	90 x 7



Neurosurgery

Pituitary Instruments



FF589R-FF591R

PAPAVERO-HARTMANN (CASPAR) Transsphenoidal Speculum, Slim, W/ Key

Catalog Number	Blade Size (mm)	Description	Length (in.)
FF589R	80 x 11	-	-
FF590R	90 x 13	-	-
FF591R	100 x 15	-	-
TE749R	-	HEX KEY	-
FF595R	34 x 9	SPREADER FOR FF589R-FF591R	5 1/2



TE749R



FF595R



FF595R



FF590B

Noir Transsphenoidal Specula

Catalog Number	Blade Size (mm)
FF590B	90 x 13

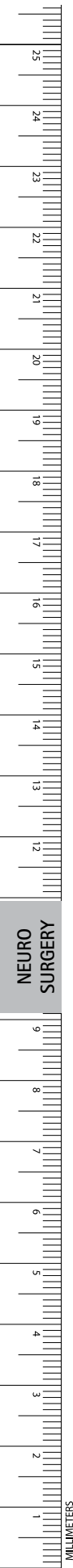

NEURO SURGERY

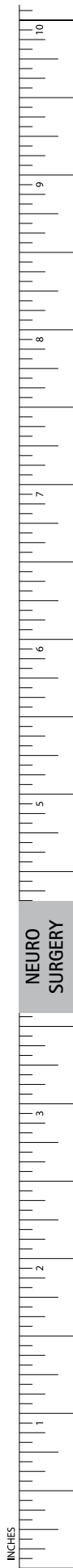



MF137R

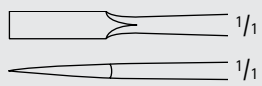

MF137R

PAPAVERO Chisel

Catalog Number	Tip	Tip Size (mm)	Shape	Length (in.)
MF137R	STR	4.0	BAYONET	9



FF611R-FF614R

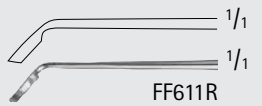

FF611R



FF614R

RAY Curette

Catalog Number	Tip	Diameter (mm)	Length (in.)
FF611R	HORIZONTAL 45°	4.0	7
FF614R	VERTICAL 45°	4.0	7

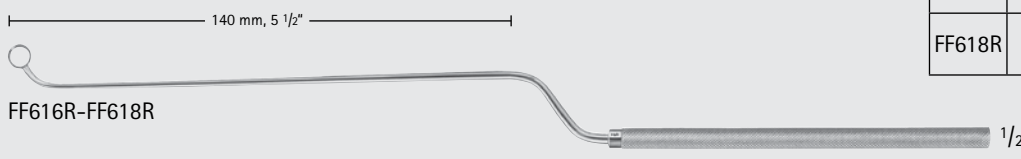

FF616R-FF618R

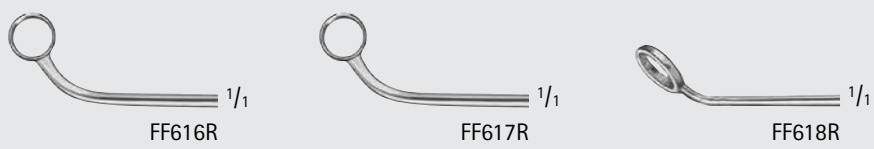

FF616R FF617R FF618R

NICOLA Curette, Malleable, Bayonet-Shaped

Catalog Number	Tip	Diameter (mm)	Working Length (in.)	Length (in.)
FF616R	CUT-RIGHT	6.5	5 1/2	10 1/4
FF617R	CUT-LEFT	6.5	5 1/2	10 1/4
FF618R	-	6.5	5 1/2	10 1/4

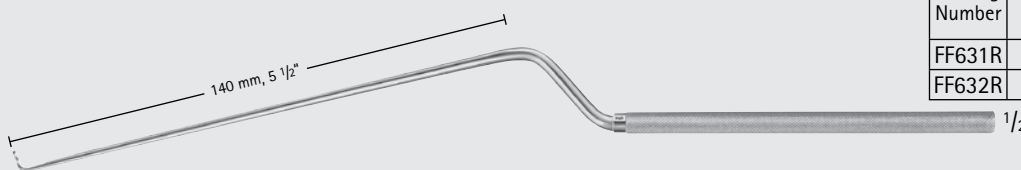

FF631R-FF632R

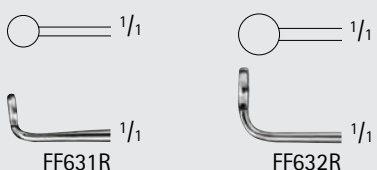

FF631R FF632R

HARDY Curette, Malleable, Bayonet-Shaped

Catalog Number	Diameter (mm)	Working Length (in.)	Length (in.)
FF631R	4.0	5 1/2	10 1/4
FF632R	6.0	5 1/2	10 1/4

Neurosurgery

Pituitary Instruments

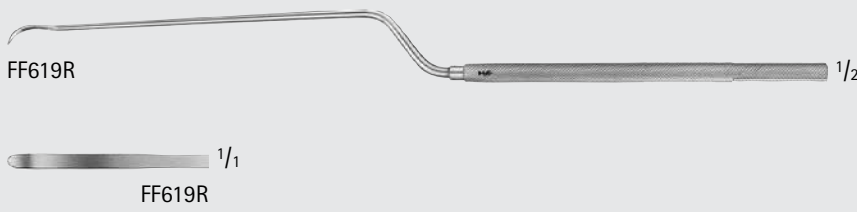

NICOLA Raspatory, Bayonet-Shaped

Catalog Number	Length (in.)
FF619R	8 3/4

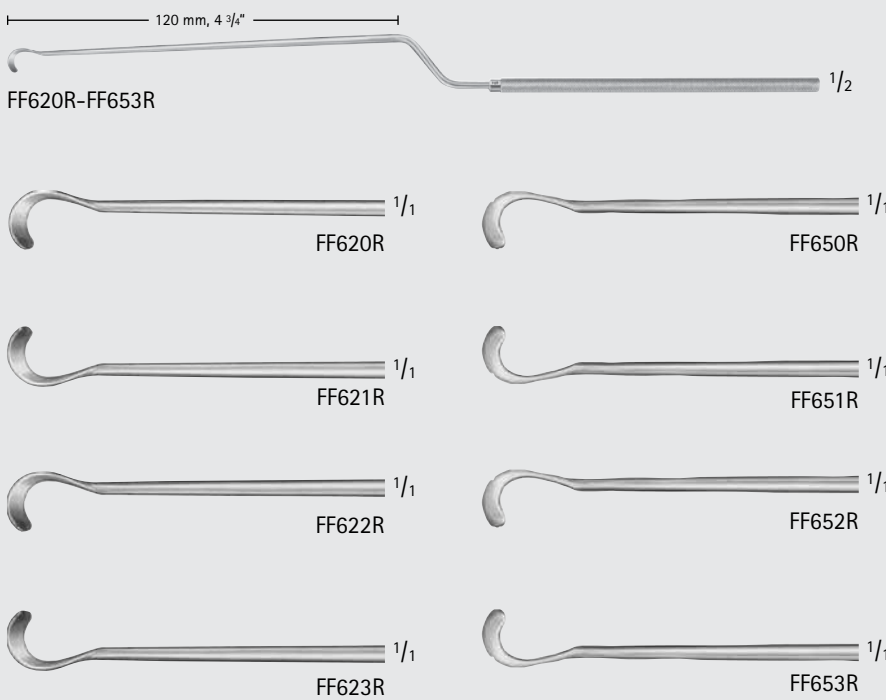

HARDY Enucleator, Bayonet-Shaped

Catalog Number	Tip	Working Length (in.)	Length (in.)
FF620R	CVD-RIGHT, CUT-RIGHT, BLUNT	4 3/4	9 5/8
FF621R	CVD-LEFT, CUT-RIGHT, BLUNT	4 3/4	9 5/8
FF622R	CVD-RIGHT, CUT-RIGHT, SHARP	4 3/4	9 5/8
FF623R	CVD-LEFT, CUT-RIGHT, SHARP	4 3/4	9 5/8
FF650R	CVD-RIGHT, CUT-LEFT, BLUNT	4 3/4	9 5/8
FF651R	CVD-LEFT, CUT-LEFT, BLUNT	4 3/4	9 5/8
FF652R	CVD-RIGHT, CUT-LEFT, SHARP	4 3/4	9 5/8
FF653R	CVD-LEFT, CUT-LEFT, SHARP	4 3/4	9 5/8

NEURO SURGERY

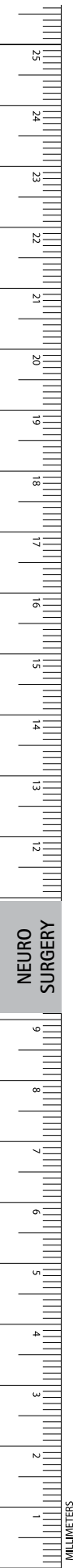

**HARDY-FAHLBUSCH Dissector,
Bayonet-Shaped**

Catalog Number	Tip	Working Length (in.)	Length (in.)
FF608R	CVD-RIGHT, CUT-LEFT, SHARP	4 3/4	9 5/8
FF609R	CVD-LEFT, CUT-RIGHT, SHARP	4 3/4	9 5/8

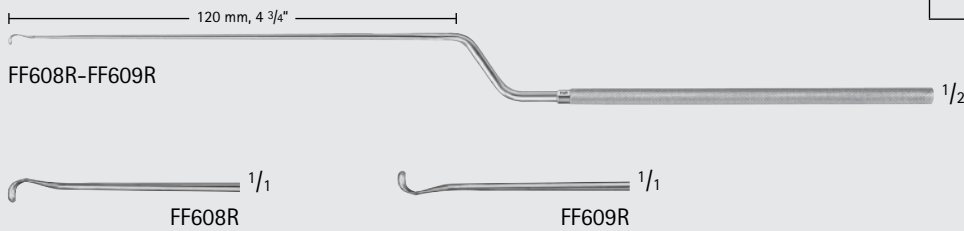

HARDY Implant Fork, Bayonet-Shaped

Catalog Number	Working Length (in.)	Length (in.)
FF624R	4 3/4	9 5/8

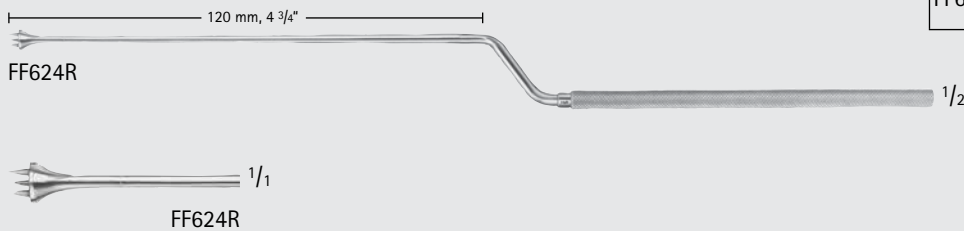

NICOLA Curette

Catalog Number	Tip	Diameter (mm)	Handle	Working Length (in.)	Length (in.)
FA030R	VERTICAL 45°	6.5	STR	5 1/2	10 1/2
FA031R	HORIZONTAL 45°	6.5	STR	5 1/2	10 1/2

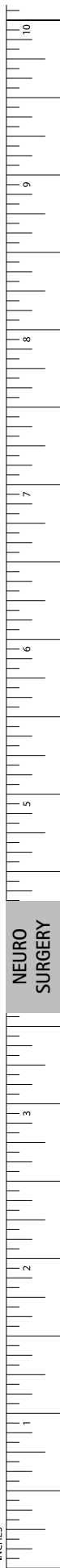
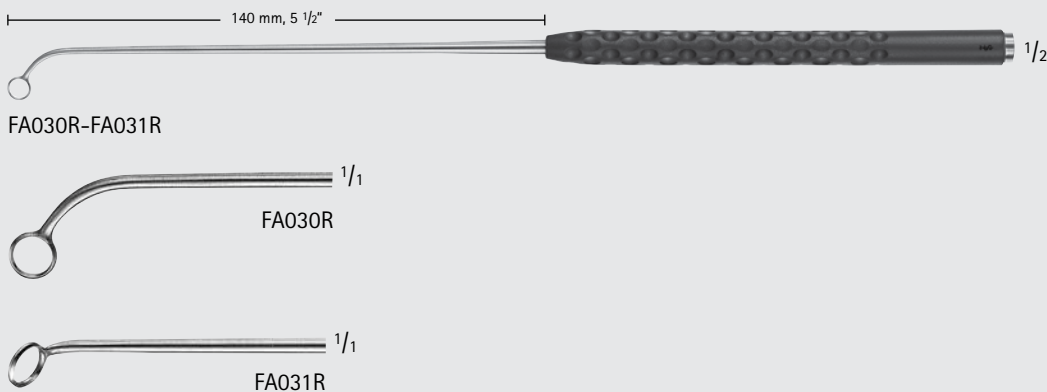

Neurosurgery

Pituitary Instruments

HARDY Eucleator

Catalog Number	Tip	Handle	Working Length (in.)	Length (in.)
FA032R	CVD-LEFT, CUT-LEFT	STR	5 1/2	10 1/2
FA033R	CVD-LEFT, CUT-RIGHT	STR	5 1/2	10 1/2



FA032R-FA033R



FA032R



FA033R

HARDY Curette

Catalog Number	Tip	Diameter (mm)	Handle	Working Length (in.)	Length (in.)
FA036R	45° SHORT NECK	4.0	STR	5 1/2	10 1/2
FA034R	90° LONG NECK	4.0	STR	5 1/2	10 1/2
FA035R	90° SHORT NECK	4.0	STR	5 1/2	10 1/2
FA037R	90° LONG NECK	6.0	STR	5 1/2	10 1/2
FA038R	90° SHORT NECK	6.0	STR	5 1/2	10 1/2



FA034R-FA038R

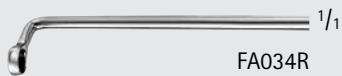

FA034R

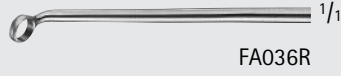

FA036R



FA035R

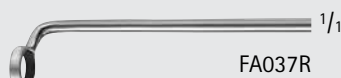

FA037R

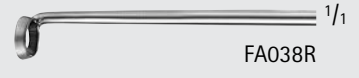

FA038R

LANDOLT-REULEN Hook

Catalog Number	Diameter (mm)	Handle	Working Length (in.)	Length (in.)
FA039R	1.7	STR	5 1/2	10 1/2



FA039R



FA039R

NEURO SURGERY

LANDOLT-REULEN Dissector

Catalog Number	Diameter (mm)	Handle	Working Length (in.)	Length (in.)
FA040R	2.0	STR	5 1/2	10 1/2



NICOLA Curette, Bayonet-Shaped

Catalog Number	Tip	Diameter (mm)	Working Length (in.)	Length (in.)
FA041R	VERTICAL 45°	6.5	5 1/8	11
FA042R	HORIZONTAL 45°	6.5	5 1/8	11

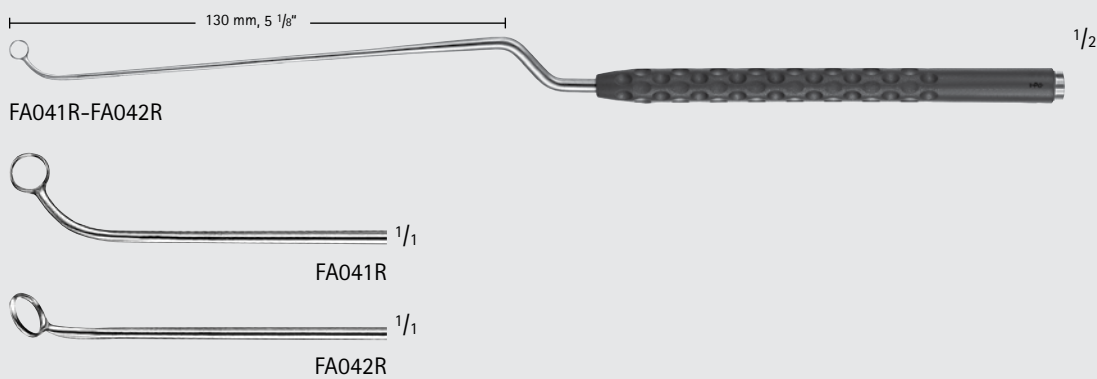

HARDY Enucleator, Bayonet-Shaped

Catalog Number	Tip	Working Length (in.)	Length (in.)
FA043R	CVD-LEFT, CUT-LEFT	5 1/8	11
FA044R	CVD-LEFT, CUT-RIGHT	5 1/8	11

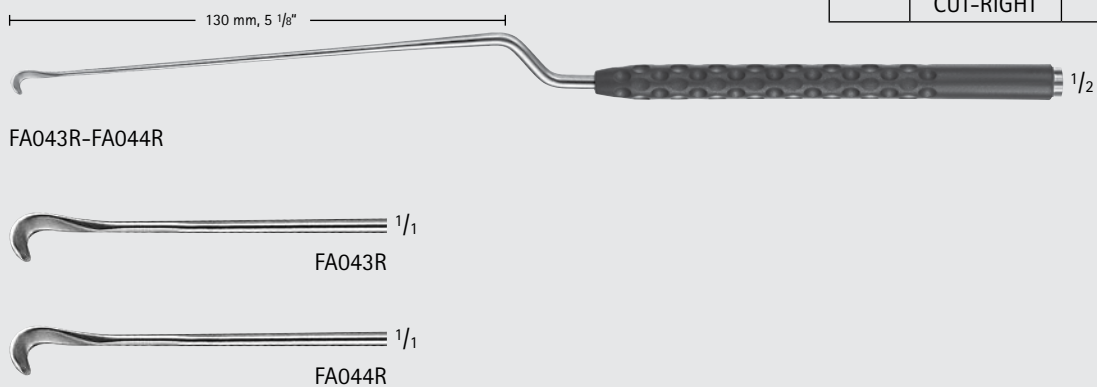

INCHES

Neurosurgery

Pituitary Instruments

HARDY Curette, Bayonet-Shaped

Catalog Number	Tip	Diameter (mm)	Working Length (in.)	Length (in.)
FA045R	90° LEFT/ LONG NECK	4.0	5 1/8	11
FA046R	90° LEFT/ SHORT NECK	4.0	5 1/8	11
FA047R	90° RIGHT/ LONG NECK	4.0	5 1/8	11
FA060R	90° RIGHT/ SHORT NECK	4.0	5 1/8	11
FA061R	45° LEFT HORIZONTAL/ SHORT NECK	4.0	5 1/8	11
FA062R	45° RIGHT HORIZONTAL/ SHORT NECK	4.0	5 1/8	11
FA063R	90° LEFT/ LONG NECK	6.0	5 1/8	11
FA064R	90° LEFT/ SHORT NECK	6.0	5 1/8	11
FA065R	90° RIGHT/ LONG NECK	6.0	5 1/8	11
FA066R	90° RIGHT/ SHORT NECK	6.0	5 1/8	11

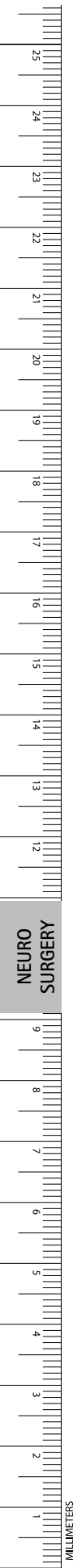
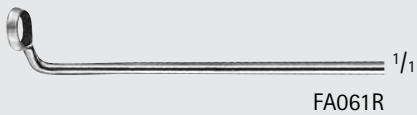
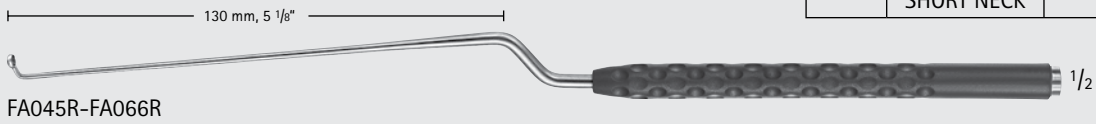

NEURO SURGERY

**LANDOLT-REULEN Hook,
Bayonet-Shaped**

Catalog Number	Diameter (mm)	Working Length (in.)	Length (in.)
FA067R	1.7	5 1/8	11

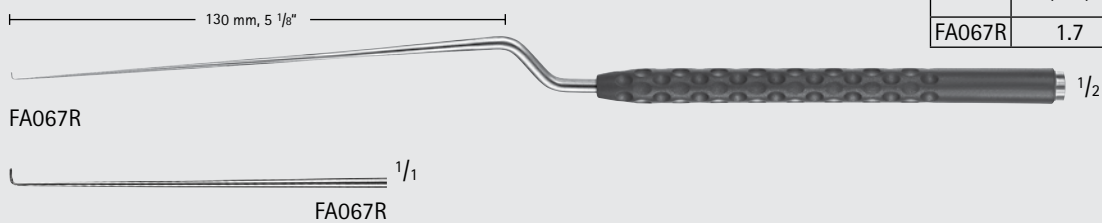

**LANDOLT-REULEN Dissector,
Bayonet-Shaped**

Catalog Number	Diameter (mm)	Working Length (in.)	Length (in.)
FA068R	2.0	5 1/8	11

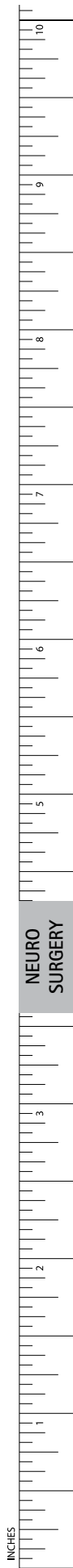
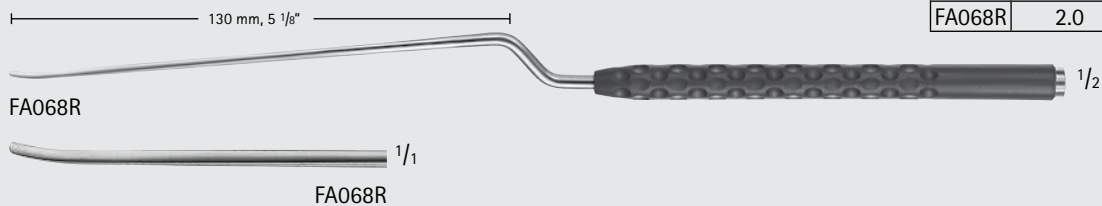

NEURO SURGERY

INCHES

Neurosurgery

Pituitary Instruments

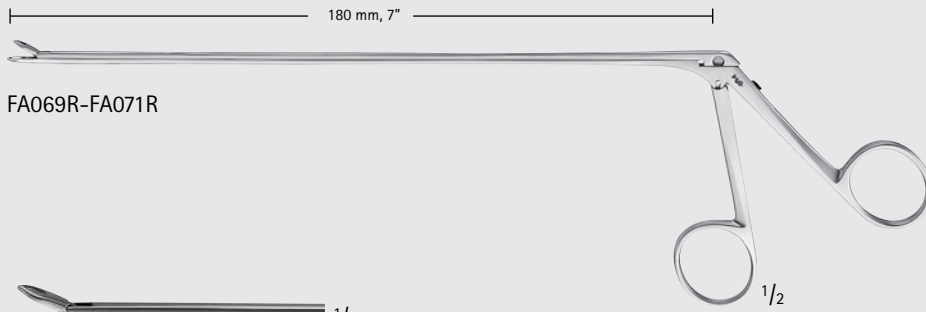
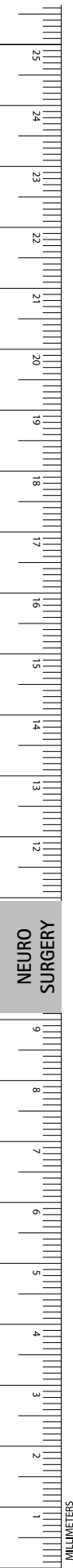

FA069R-FA071R

Micro Forceps

Catalog Number	Blade	Length (in.)
FA069R	STR	7
FA070R	CVD-RIGHT	7
FA071R	CVD-LEFT	7



FA069R



FA070R



FA071R

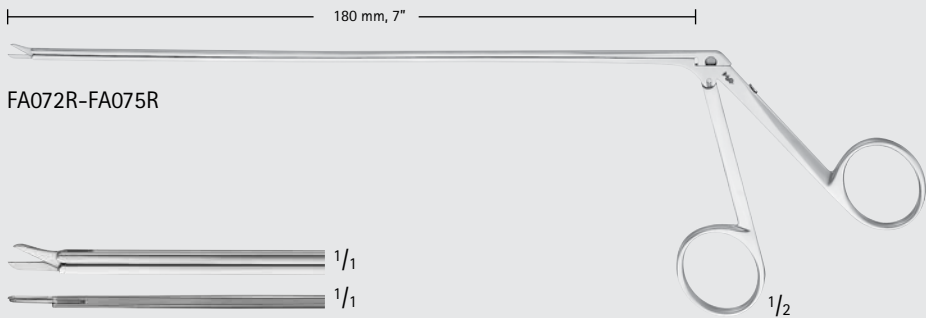

FA072R-FA075R

Micro Scissors

Catalog Number	Blade	Length (in.)
FA072R	STR	7
FA073R	CVD-LEFT	7
FA074R	CVD-RIGHT	7
FA075R	ANG	7



FA072R

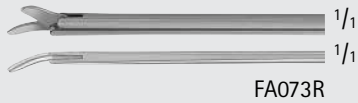

FA073R



FA074R



FA075R

NEURO SURGERY

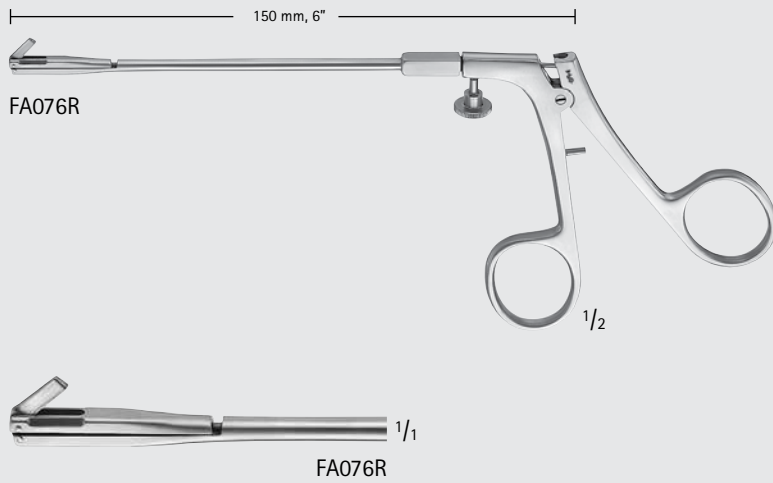

Antrum Punch, Backwards Cutting

Catalog Number	Shaft	Working Length (in.)	Length (in.)
FA076R	ROTATABLE 360°	4 3/4	6

Rotatable Ring Curette

Catalog Number	Tip	Tip Size (mm)	Length (in.)
MF112R	45°, BLUNT	2.0	10 1/2
MF113R	45°, BLUNT	3.0	10 1/2
MF114R	45°, BLUNT	4.0	10 1/2
MF115R	45°, BLUNT	5.0	10 1/2
MF116R	90°, BLUNT	2.0	10 1/2
MF117R	90°, BLUNT	3.0	10 1/2
MF118R	90°, BLUNT	4.0	10 1/2
MF119R	90°, BLUNT	5.0	10 1/2
MF120R	90°, BLUNT	6.0	10 1/2
MF121R	45°, SHARP	2.0	10 1/2
MF122R	45°, SHARP	3.0	10 1/2
MF123R	45°, SHARP	4.0	10 1/2
MF124R	45°, SHARP	5.0	10 1/2
MF125R	90°, SHARP	2.0	10 1/2
MF126R	90°, SHARP	3.0	10 1/2
MF127R	90°, SHARP	4.0	10 1/2
MF128R	90°, SHARP	5.0	10 1/2



Neurosurgery

Pituitary Instruments

LANDOLT Spatula, Bayonet-Shaped

Catalog Number	Shaft	Working Length (in.)	Length (in.)
FF627R	MALLEABLE	6 1/8	10 1/4

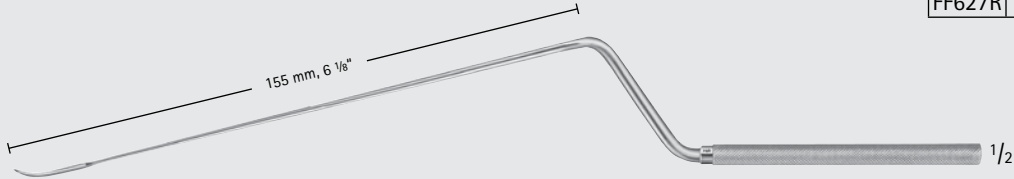

FF627R



FF627R



LANDOLT Spoon, Bayonet-Shaped

Catalog Number	Shaft	Working Length (in.)	Length (in.)
FF628R	MALLEABLE	6 1/8	10 1/4

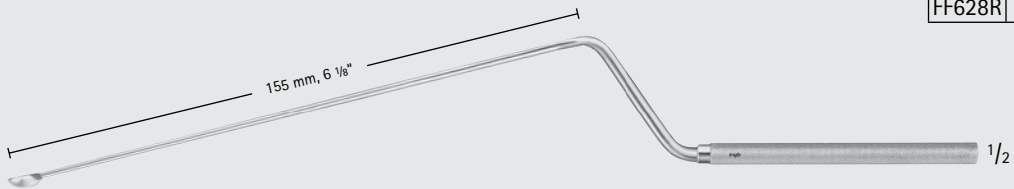

FF628R



FF628R

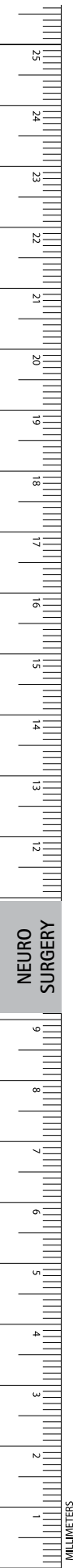

NEURO SURGERY

LANDOLT Hook, Blunt, Bayonet-Shaped

Catalog Number	Shaft	Working Length (in.)	Length (in.)
FF629R	MALLEABLE	6 1/8	10 1/4

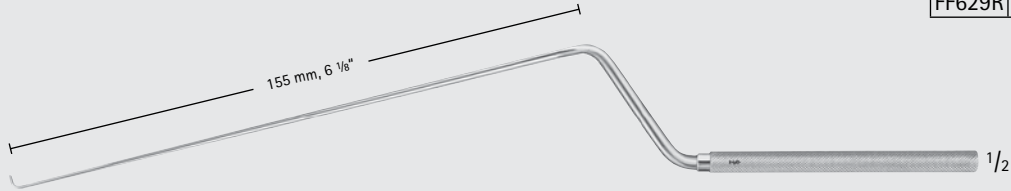

FF629R



FF629R

LANDOLT Enucleator, Malleable, Bayonet-Shaped

Catalog Number	Tip	Working Length (in.)	Length (in.)
FF625R	RIGHT BLUNT DOWN	6 1/8	10 1/4
FF626R	RIGHT BLUNT UP	6 1/8	10 1/4

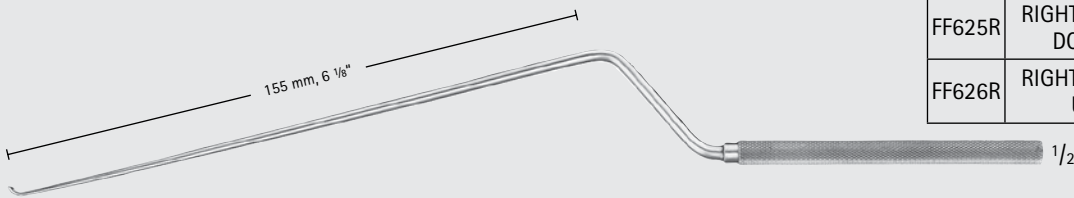

FF625R-FF626R



FF625R



FF626R

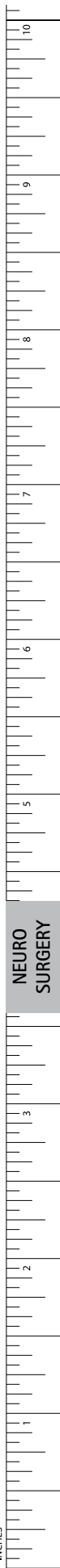

INCHES

Neurosurgery

Pituitary Instruments

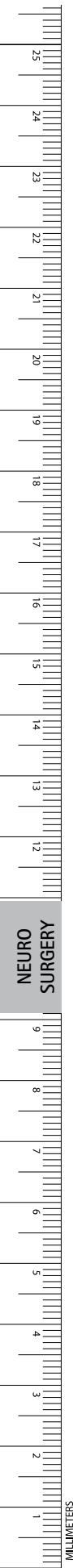

LANDOLT-REULEN Raspatory, Bayonet-Shaped

Catalog Number	Diameter (mm)	Shaft	Working Length (in.)	Length (in.)
FF640R	2.2	RIGID	6 1/8	10 1/4
FF641R	3.2	RIGID	6 1/8	10 1/4

155 mm, 6 1/8"

1/2

FF640R-FF641R

1/1
FF640R

1/1
FF641R

LANDOLT-REULEN Curette, Bayonet-Shaped

Catalog Number	Diameter (mm)	Shaft	Working Length (in.)	Length (in.)
FF642R	2.5	RIGID	6 1/8	10 1/4

155 mm, 6 1/8"

1/2

FF642R

1/1

1/1
FF642R

LANDOLT-REULEN Hook, Blunt, Bayonet-Shaped

Catalog Number	Tip Size (mm)	Shaft	Working Length (in.)	Length (in.)
FF643R	1.7	RIGID	6 1/8	10 1/4

155 mm, 6 1/8"

1/2

FF643R

1/1
FF643R

LANDOLT-REULEN Dissector, Bayonet-Shaped

Catalog Number	Diameter (mm)	Shaft	Working Length (in.)	Length (in.)
FF644R	2.0	RIGID	6 1/8	10 1/4

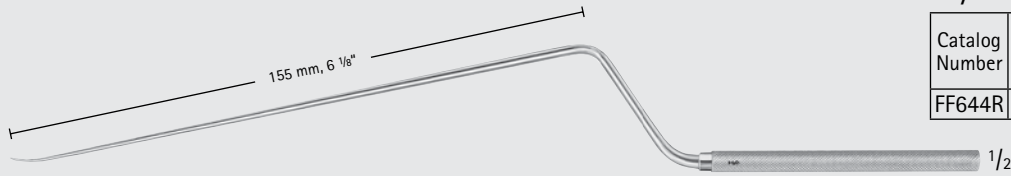

FF644R

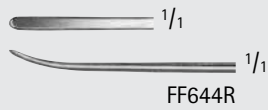

FAHLBUSCH Spoon, Bayonet-Shaped

Catalog Number	Diameter (mm)	Shaft	Working Length (in.)	Length (in.)
FF635R	2.0	MALLEABLE	6 1/8	10 1/4

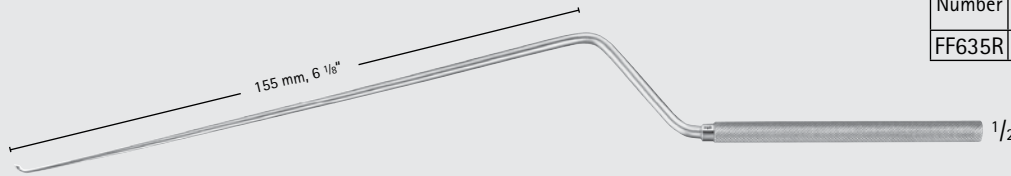

FF635R



FAHLBUSCH Curette, Bayonet-Shaped

Catalog Number	Diameter (mm)	Shaft	Working Length (in.)	Length (in.)
FF637R	2.5	MALLEABLE	6 1/8	10 1/4

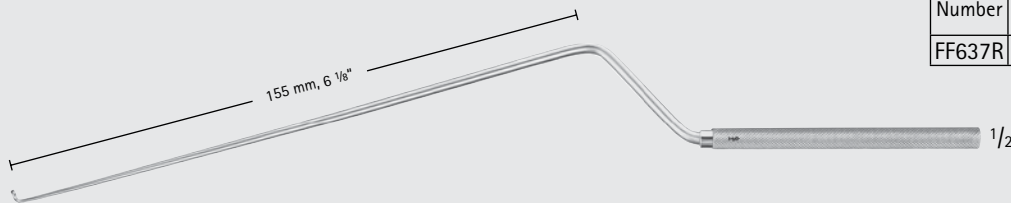

FF637R



D'ERRICO Hypophyseal Forceps

Catalog Number	Jaw	Jaw Size (mm)	Length (in.)
MF410R	CUP	6.0	8 1/2



MF410R



MF410R

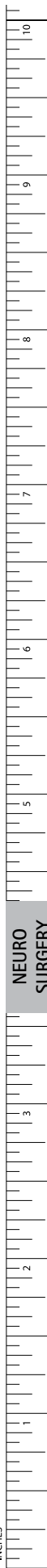

Neurology

Pituitary Instruments

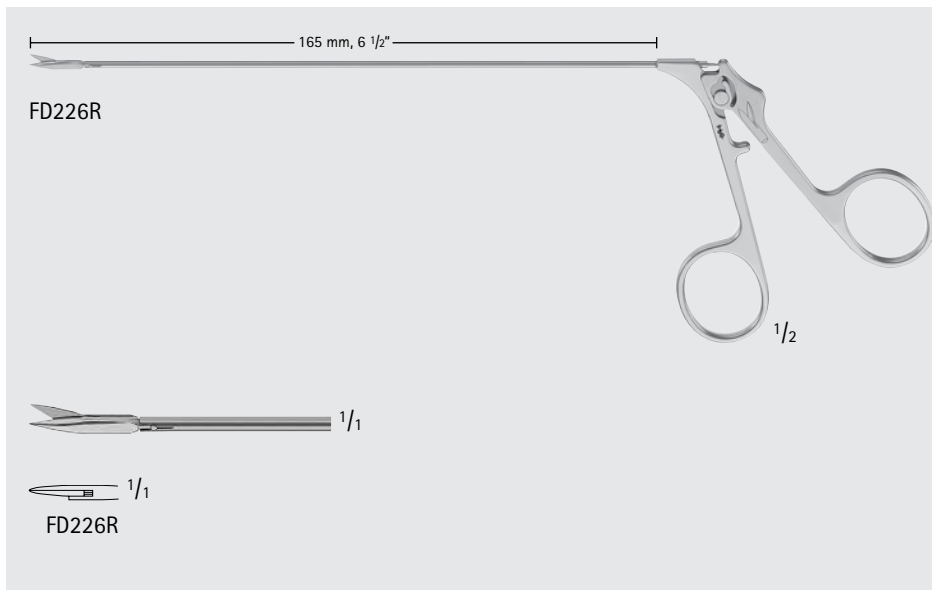
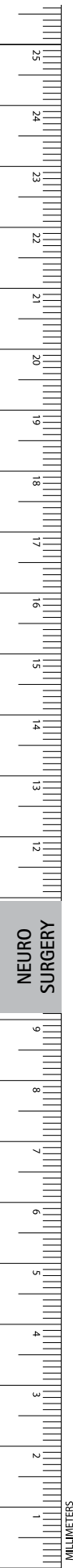

NICOLA Modular Micro Scissors

Catalog Number	Tip	Blade	Shaft	Working Length (in.)
FD226R	S/S	STR	TUBULAR	6 1/2

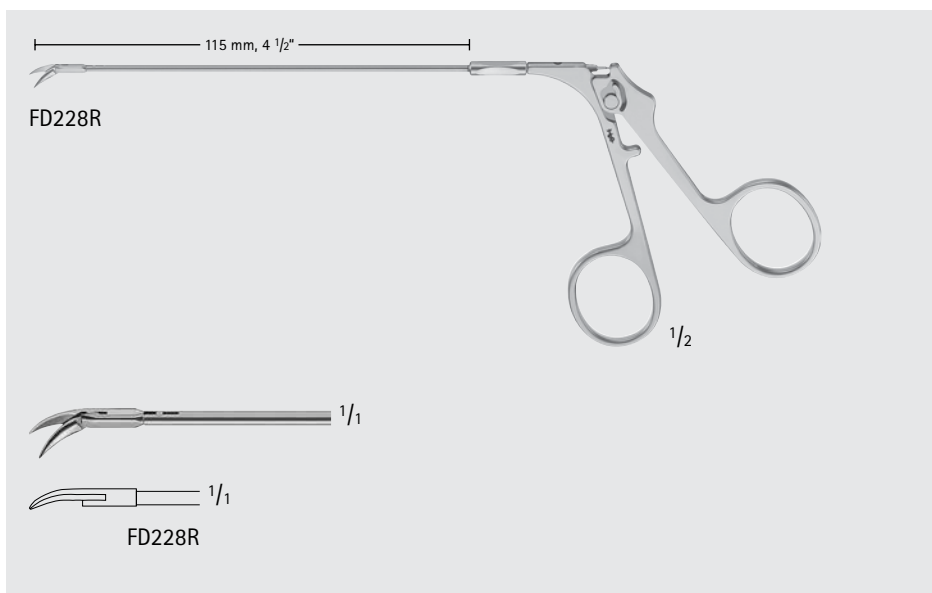

CASPAR Modular Micro Scissors

Catalog Number	Tip	Blade	Shaft	Working Length (in.)
FD228R	S/S	CVD	ROTATABLE 360°	4 1/2

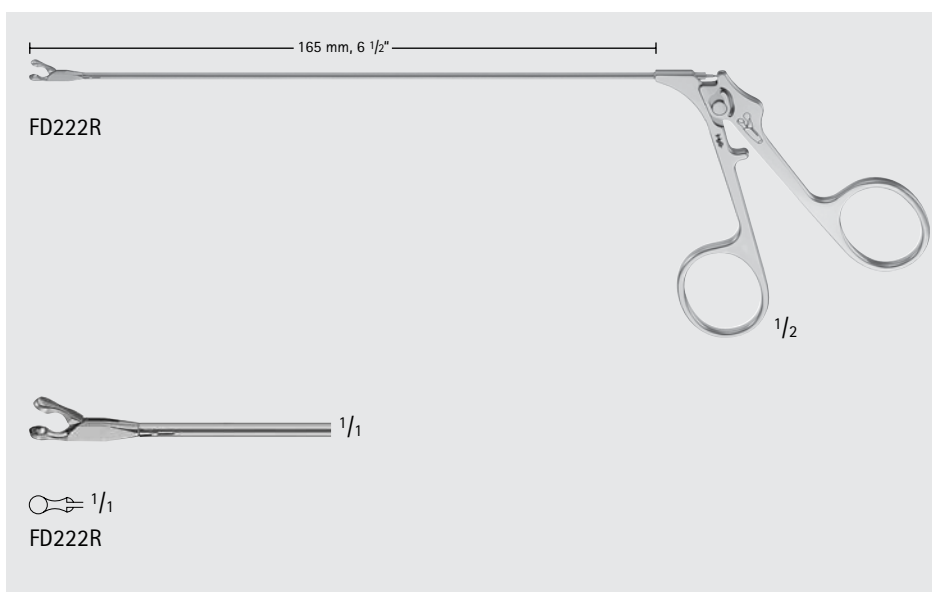

NICOLA Modular Micro Forceps

Catalog Number	Jaw	Tip Size (mm)	Working Length (in.)
FD222R	SCOOP-SHAPED	DIAM. 2.5 MM	6 1/2

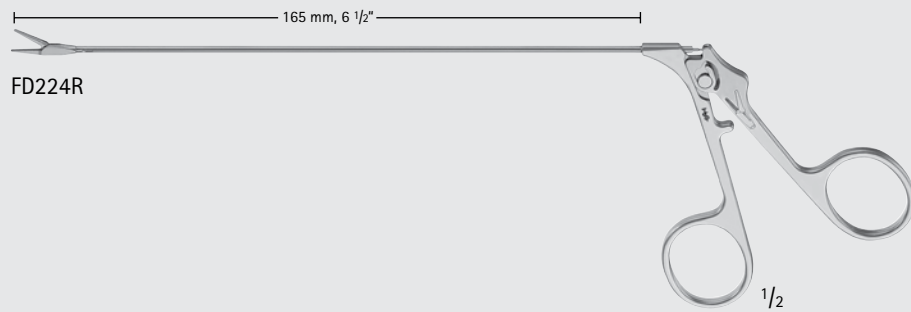

FD224R

YASARGIL-NICOLA Modular Micro Forceps

Catalog Number	Jaw	Tip	Working Length (in.)
FD224R	LONG	STR, SERR	6 1/2



FD224R

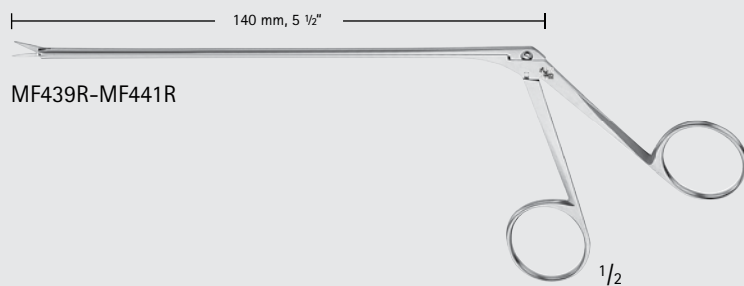

MF439R-MF441R

KURZE Dissecting Scissors

Catalog Number	Tip	Blade	Length (in.)
MF439R	B/B	STR	5 1/2
MF440R	B/B	CVD-LEFT	5 1/2
MF441R	B/B	CVD-RIGHT	5 1/2

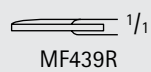

MF439R

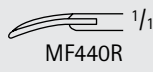

MF440R



MF441R

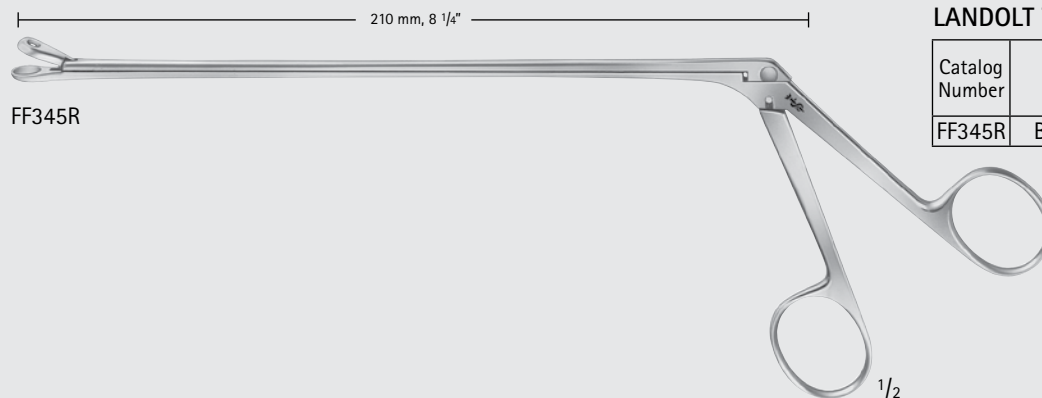

FF345R

LANDOLT Tumor Grasping Forceps

Catalog Number	Jaw	Jaw Size (mm)	Shaft Length (in.)
FF345R	BLUNT	DIAM. 9.0	8 1/4

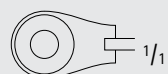

FF345R

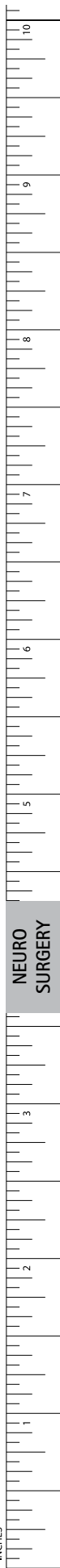

NEURO SURGERY

INCHES

Neurosurgery

Suction Cannulas

- Teardrop shaped thumb control for a very precise suction regulation
- Malleable material for individual forming of the suction hose
- Conical design of the tube prevents plugging
- Delivered with stylet

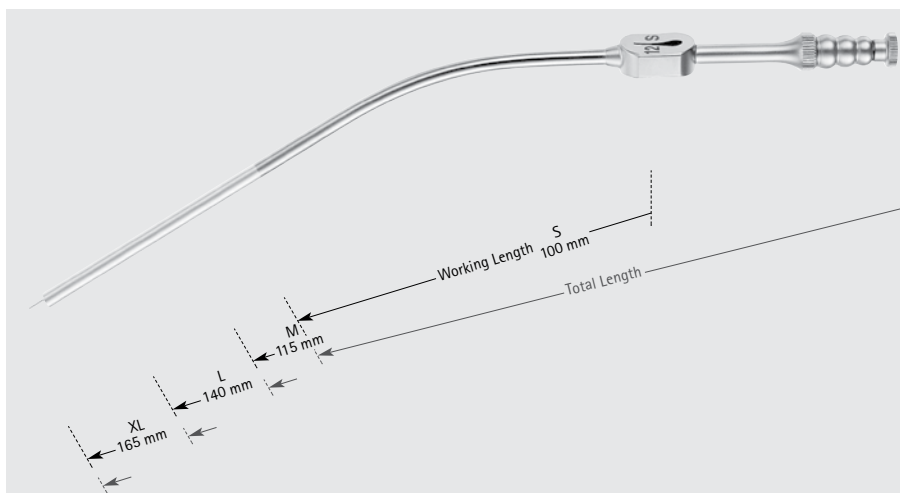

GF391R-GF429R

Suction Tube, Fukushima Style, W/ Tapered Teardrop Control

Catalog Number	Size	Tip Size (mm)	Tip Size (FR)	Working Length (in.)	Length (in.)
GF401R	S	1.0	3	4	6 1/2
GF402R	S	1.4	4	4	6 1/2
GF403R	S	1.7	5	4	6 1/2
GF404R	S	2.0	6	4	6 1/2
GF405R	S	2.3	7	4	6 1/2
GF406R	S	2.7	8	4	6 1/2
GF407R	S	3.0	9	4	6 1/2
GF408R	S	3.3	10	4	6 1/2
GF409R	S	4.0	12	4	6 1/2
GF391R	M	1.0	3	4 1/2	7
GF392R	M	1.4	4	4 1/2	7
GF393R	M	1.7	5	4 1/2	7
GF394R	M	2.0	6	4 1/2	7
GF395R	M	2.3	7	4 1/2	7
GF396R	M	2.7	8	4 1/2	7
GF397R	M	3.0	9	4 1/2	7
GF398R	M	3.3	10	4 1/2	7
GF399R	M	4.0	12	4 1/2	7
GF411R	L	1.0	3	5 1/2	8
GF412R	L	1.4	4	5 1/2	8
GF413R	L	1.7	5	5 1/2	8
GF414R	L	2.0	6	5 1/2	8
GF415R	L	2.3	7	5 1/2	8
GF416R	L	2.7	8	5 1/2	8
GF417R	L	3.0	9	5 1/2	8
GF418R	L	3.3	10	5 1/2	8
GF419R	L	4.0	12	5 1/2	8
GF421R	XL	1.0	3	6 1/2	9
GF422R	XL	1.4	4	6 1/2	9
GF423R	XL	1.7	5	6 1/2	9
GF424R	XL	2.0	6	6 1/2	9
GF425R	XL	2.3	7	6 1/2	9
GF426R	XL	2.7	8	6 1/2	9
GF427R	XL	3.0	9	6 1/2	9
GF428R	XL	3.3	12	6 1/2	9
GF429R	XL	4.0	12	6 1/2	9

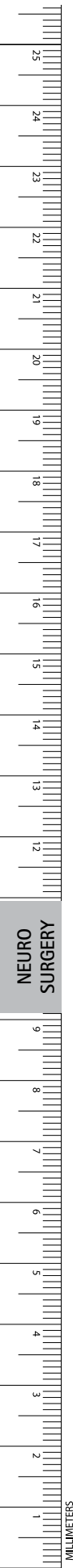



GF025B-GF059B



MIN Instruments, Noir™ Modular Suction Cannula,
F/ Golfball Handle

Catalog Number	Size	Tip	Tip Size (mm)	Tip Size (FR)	Working Length (in.)
GF025B	S	STR	1.4	4	3 1/8
GF026B	S	STR	2.0	6	3 1/8
GF027B	S	STR	2.7	8	3 1/8
GF030B	M	CVD LEFT	2.0	6	4
GF031B	M	CVD RIGHT	2.0	6	4
GF032B	M	CVD LEFT	2.7	8	4
GF033B	M	CVD RIGHT	2.7	8	4
GF035B	M	STR	1.4	4	4
GF036B	M	STR	2.0	6	4
GF037B	M	STR	2.7	8	4
GF038B	M	STR, LATERAL HOLES	2.0	6	4
GF039B	M	STR, LATERAL HOLES	2.7	8	4
GF045B	L	STR	1.4	4	4 3/4
GF046B	L	STR	2.0	6	4 3/4
GF047B	L	STR	2.7	8	4 3/4
GF048B	L	STR, LATERAL HOLES	2.0	6	4 3/4
GF049B	L	STR, LATERAL HOLES	2.7	8	4 3/4
GF055B	XL	STR	1.4	4	5 1/2
GF056B	XL	STR	2.0	6	5 1/2
GF057B	XL	STR	2.7	8	5 1/2
GF058B	XL	STR, LATERAL HOLES	2.0	6	5 1/2
GF059B	XL	STR, LATERAL HOLES	2.7	8	5 1/2



GF005B

Modular Thumb Control for MIN
Suction Cannulas

Catalog Number	Description
GF005B	TEAR DROP SHAPED



Neurosurgery

Suction Cannulas

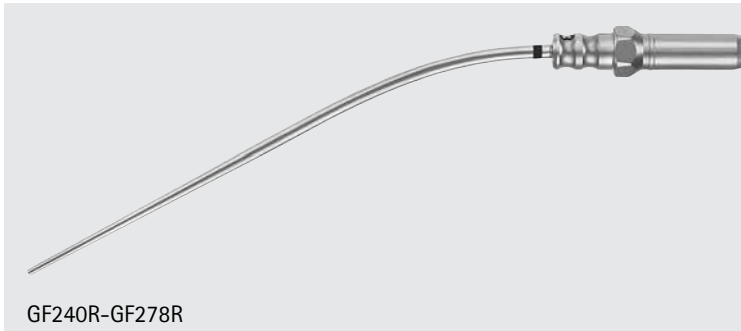
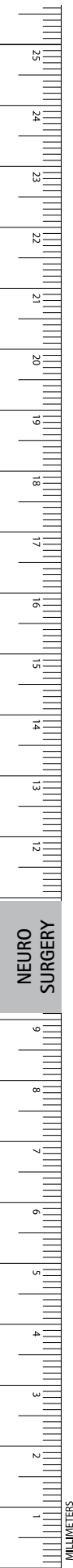

GF240R-GF278R

Modular Suction Cannula

Catalog Number	Size)	Tip Size (mm)	Tip Size (FR)	Working Length (in.)	Length (in.)
GF240R	S	1.0	3	4	7 1/4
GF241R	S	1.4	4	4	7 1/4
GF242R	S	1.7	5	4	7 1/4
GF243R	S	2.0	6	4	7 1/4
GF244R	S	2.3	7	4	7 1/4
GF245R	S	2.7	8	4	7 1/4
GF246R	S	2.0	9	4	7 1/4
GF247R	S	3.3	10	4	7 1/4
GF248R	S	4.0	12	4	7 1/4
GF250R	M	1.0	3	4 1/2	7 7/8
GF251R	M	1.4	4	4 1/2	7 7/8
GF252R	M	1.7	5	4 1/2	7 7/8
GF253R	M	2.0	6	4 1/2	7 7/8
GF254R	M	2.3	7	4 1/2	7 7/8
GF255R	M	2.7	8	4 1/2	7 7/8
GF256R	M	3.0	9	4 1/2	7 7/8
GF257R	M	3.3	10	4 1/2	7 7/8
GF258R	M	4.0	12	4 1/2	7 7/8
GF260R	L	1.0	3	5 1/2	8 7/8
GF261R	L	1.4	4	5 1/2	8 7/8
GF262R	L	1.7	5	5 1/2	8 7/8
GF263R	L	2.0	6	5 1/2	8 7/8
GF264R	L	2.3	7	5 1/2	8 7/8
GF265R	L	2.7	8	5 1/2	8 7/8
GF266R	L	3.0	9	5 1/2	8 7/8
GF267R	L	3.3	10	5 1/2	8 7/8
GF268R	L	4.0	12	5 1/2	8 7/8
GF270R	XL	1.0	3	6 1/2	9 3/4
GF271R	XL	1.4	4	6 1/2	9 3/4
GF272R	XL	1.7	5	6 1/2	9 3/4
GF273R	XL	2.0	6	6 1/2	9 3/4
GF274R	XL	2.3	7	6 1/2	9 3/4
GF275R	XL	2.7	8	6 1/2	9 3/4
GF276R	XL	3.0	9	6 1/2	9 3/4
GF277R	XL	3.3	10	6 1/2	9 3/4
GF278R	XL	4.0	12	6 1/2	9 3/4



GF235R

Thumb Control for Modular Suction Tubes

Catalog Number	Shape
GF235R	TEARDROP SHAPED

RAABE Micro Suction Tube, W/ Tapered Teardrop Control

Catalog Number	Tip	Tip Size (mm)	Tip Size (FR)	Handle	Working Length (in.)	Length (in.)
GF470R	ATRAUMATIC	1.4	4	YELLOW	3 1/8	5 1/8
GF471R	ATRAUMATIC	2.0	6	BLUE	3 1/8	5 1/8
GF472R	ATRAUMATIC	2.7	8	GREEN	3 1/8	5 1/8
GF473R	ATRAUMATIC	1.4	4	YELLOW	4	6
GF474R	ATRAUMATIC	2.0	6	BLUE	4	6
GF475R	ATRAUMATIC	2.7	8	GREEN	4	6
GF476R	ATRAUMATIC	1.4	4	YELLOW	4 3/4	6 1/2
GF477R	ATRAUMATIC	2.0	6	BLUE	4 3/4	6 1/2
GF478R	ATRAUMATIC	2.7	8	GREEN	4 3/4	6 1/2
GF479R	ATRAUMATIC	1.4	4	YELLOW	5 1/2	7 1/4
GF480R	ATRAUMATIC	2.0	6	BLUE	5 1/2	7 1/4
GF481R	ATRAUMATIC	2.7	8	GREEN	5 1/2	7 1/4



GF470R-GF481R

Suction Tube, Fukushima Style, W/ Tapered Teardrop Control

Catalog Number	Tip	Tip Size (mm)	Tip Size (FR)	Working Length (in.)	Length (in.)
GF431R	CVD-RIGHT	2.0	8	5 1/4	9 3/4
GF432R	CVD-LEFT	2.0	5 1/4	9 3/4	

1/2

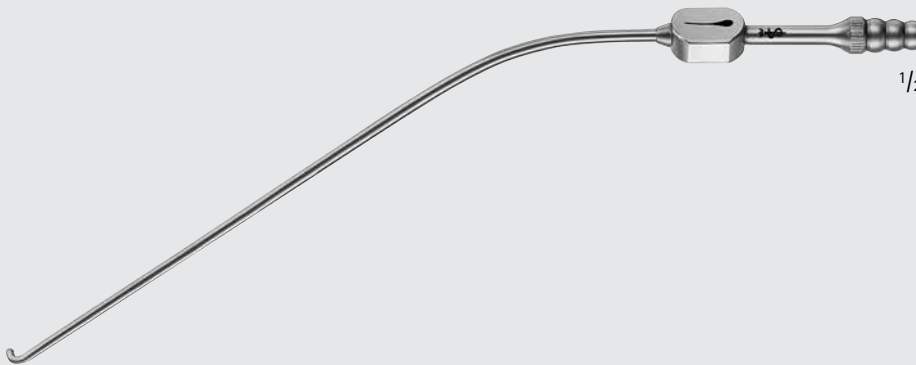

GF431R-GF432R



GF431R-GF432R

1/1



NEURO SURGERY

INCHES

Neurosurgery

Suction Cannulas

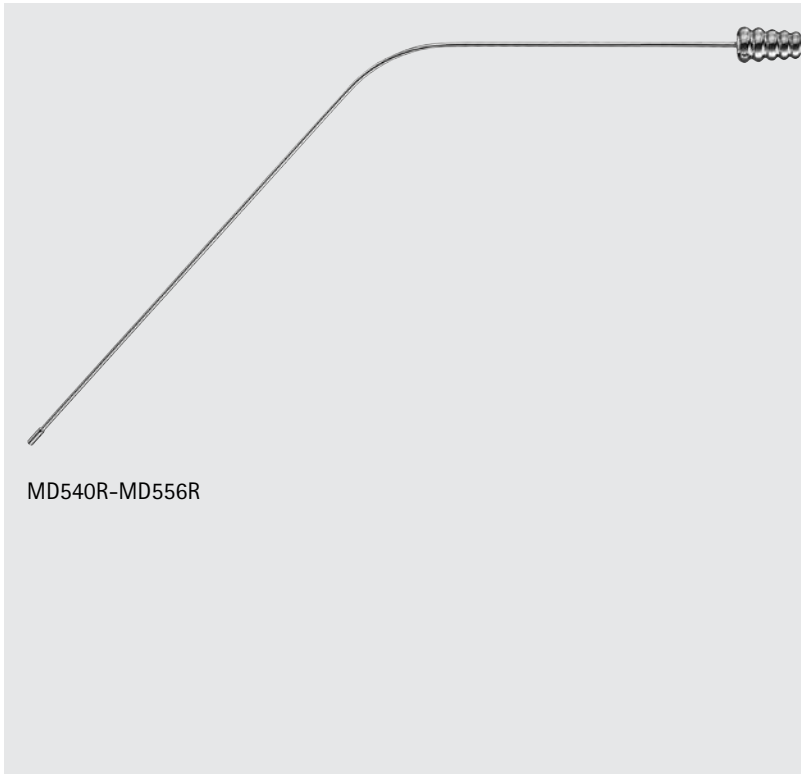
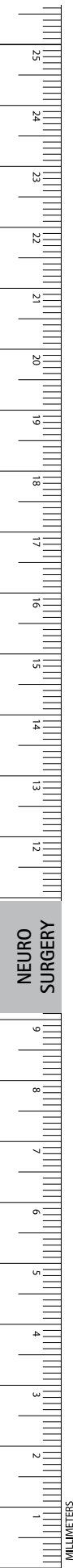

MD540R-MD566R

YASARGIL Suction Tube

Catalog Number	Tip Size (mm)	Length (in.)
MD540R	1.5	5
MD541R	1.5	6
MD542R	1.5	7
MD543R	1.5	8 1/2
MD544R	2.0	5
MD545R	2.0	6
MD546R	2.0	7
MD547R	2.0	8 1/2
MD548R	2.5	5
MD549R	2.5	6
MD550R	2.5	7
MD551R	2.5	8 1/2
MD552R	3.5	5
MD553R	3.5	6
MD554R	3.5	7
MD555R	3.5	8 1/2
MD556R	4.5	7

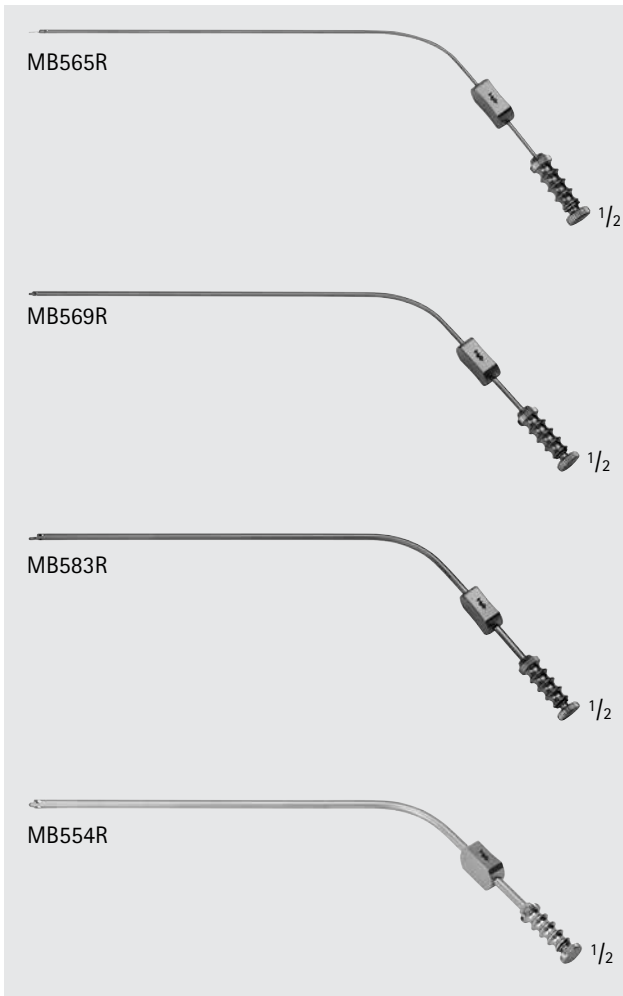

MB565R

MB569R

MB583R

MB554R

MCCULLOCH Suction Tube

Catalog Number	Tip Size (mm)	Length (in.)
MB708R	COMPLETE SET	5 3/4
MB565R	1.7	5 3/4
MB569R	2.3	5 3/4
MB583R	3.0	5 3/4
MB554R	4.0	5 3/4

MB708R Set of 4 Includes:
 1 Suction cannula of each MB554R, MB565R, MB569R, MB583R

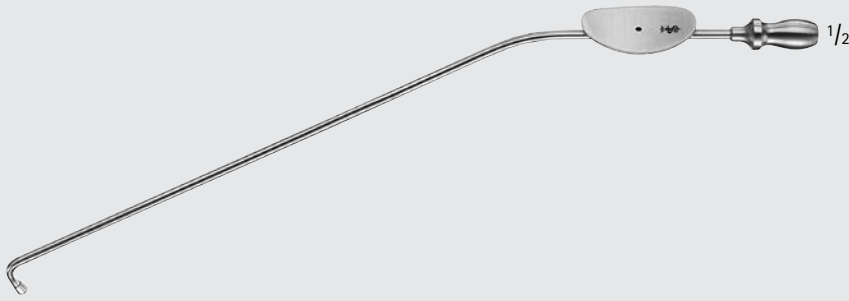

MF106R-MF111R

Atraumatic Suction Tube

Catalog Number	Tip	Tip Size (FR)	Length (in.)
MF106R	90° DOWN	5	8 1/2
MF107R	90° DOWN	7	8 1/2
MF108R	90° DOWN	10	8 1/2
MF109R	90° UP	5	8 1/2
MF110R	90° UP	7	8 1/2
MF111R	90° UP	10	8 1/2

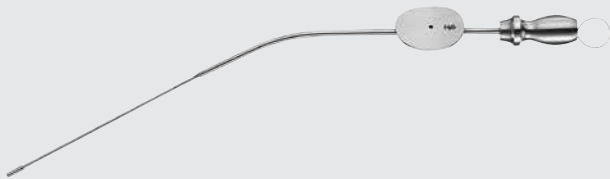

MF333R-MF347R

Atraumatic Suction Tube

Catalog Number	Tip Size (FR)	Working Length (in.)	Length (in.)
MF333R	3	3	6 1/4
MF334R	5	3	6 1/4
MF335R	7	3	6 1/4
MF336R	10	3	6 1/4
MF337R	12	3	6 1/4
MF338R	3	4	7 1/4
MF339R	5	4	7 1/4
MF340R	7	4	7 1/4
MF341R	10	4	7 1/4
MF342R	12	4	7 1/4
MF343R	3	5	8 1/4
MF344R	5	5	8 1/4
MF345R	7	5	8 1/4
MF346R	10	5	8 1/4
MF347R	12	5	8 1/4



Neurosurgery

Suction Cannulas

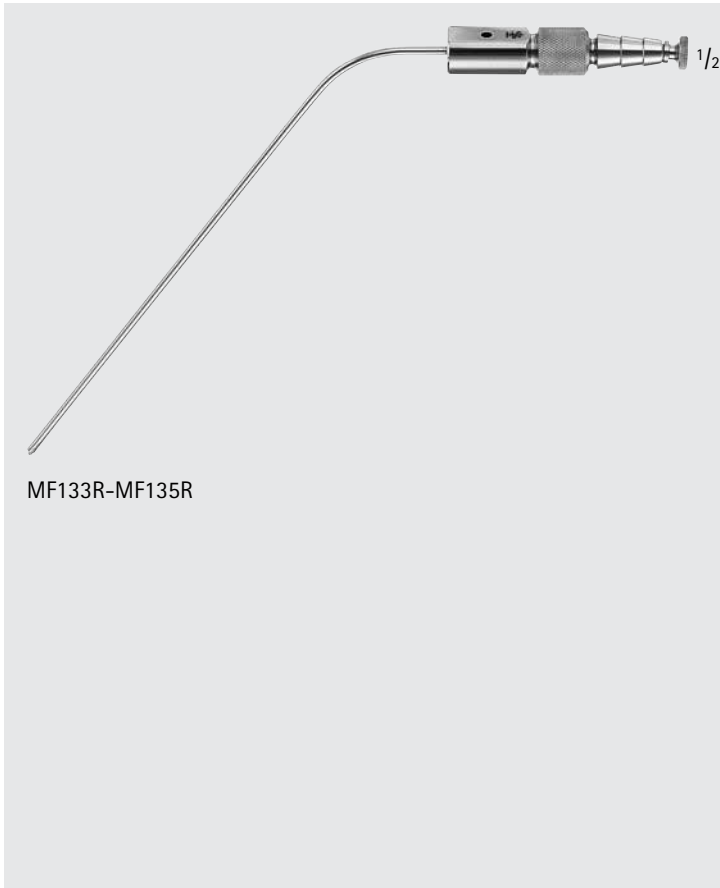
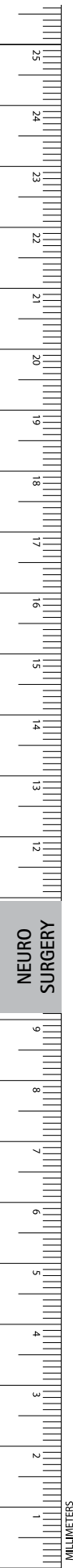

MF133R-MF135R

FRAZIER Suction Dissector

Catalog Number	Tip Size (FR)	Working Length (in.)
MF133R	5	6 1/2
MF134R	7	6 1/2
MF135R	10	6 1/2

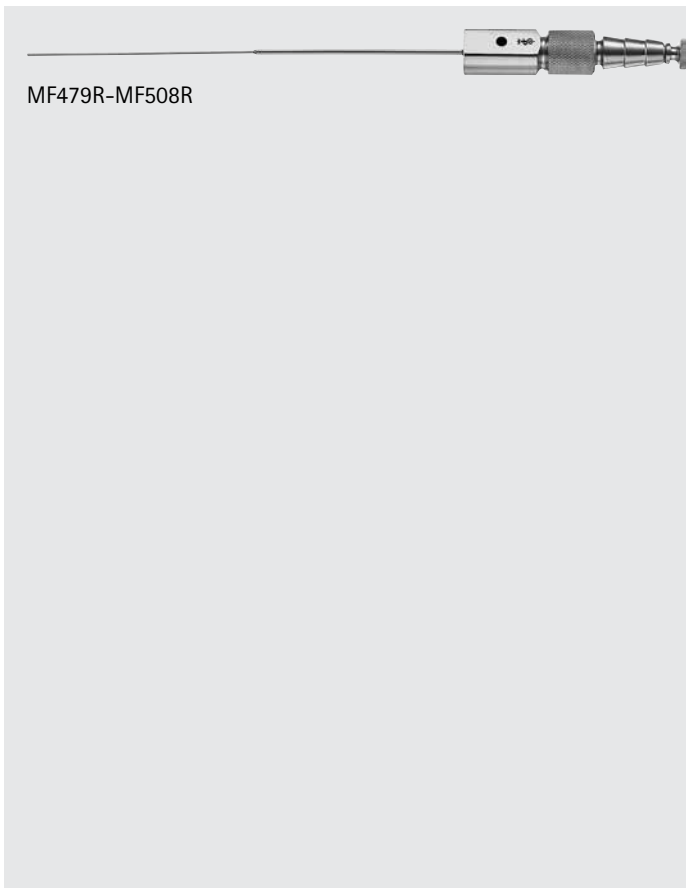

MF479R-MF508R

FRAZIER Slotted Suction Tube, Straight

Catalog Number	Tip Size (FR)	Length (in.)
MF479R	3	5 1/2
MF480R	4	5 1/2
MF481R	5	5 1/2
MF482R	6	5 1/2
MF483R	7	5 1/2
MF484R	8	5 1/2
MF485R	9	5 1/2
MF486R	10	5 1/2
MF487R	11	5 1/2
MF488R	12	5 1/2
MF499R	3	7
MF500R	4	7
MF501R	5	7
MF502R	6	7
MF503R	7	7
MF504R	8	7
MF505R	9	7
MF506R	10	7
MF507R	11	7
MF508R	12	7

NEURO SURGERY

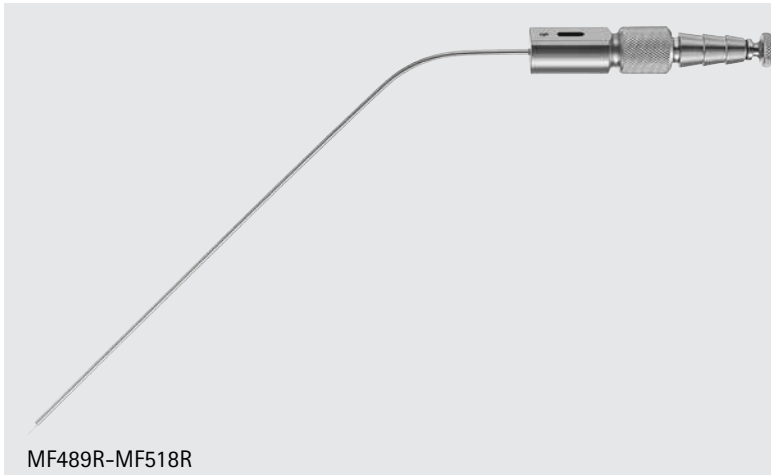

MF489R-MF518R

FRAZIER Slotted Suction Tube, Angled

Catalog Number	Tip Size (FR)	Length (in.)
MF489R	3	5 1/2
MF490R	4	5 1/2
MF491R	5	5 1/2
MF492R	6	5 1/2
MF493R	7	5 1/2
MF494R	8	5 1/2
MF495R	9	5 1/2
MF496R	10	5 1/2
MF497R	11	5 1/2
MF498R	12	5 1/2
MF509R	3	7
MF510R	4	7
MF511R	5	7
MF512R	6	7
MF513R	7	7
MF514R	8	7
MF515R	9	7
MF516R	10	7
MF517R	11	7
MF518R	12	7

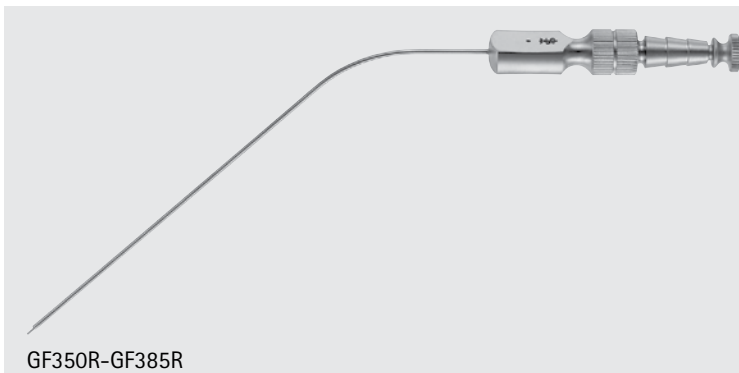

GF350R-GF385R

FERGUSSON Suction Tube, Luer Hub

Catalog Number	Diameter (mm)	Working Length (in.)	Length (in.)
GF350R	1.5	4 1/4	7 3/4
GF351R	2.0	4 1/4	7 3/4
GF352R	2.5	4 1/4	7 3/4
GF353R	3.0	4 1/4	7 3/4
GF354R	4.0	4 1/4	7 3/4
GF355R	5.0	4 1/4	7 3/4
GF360R	1.5	5 1/8	8 1/2
GF361R	2.0	5 1/8	8 1/2
GF362R	2.5	5 1/8	8 1/2
GF363R	3.0	5 1/8	8 1/2
GF364R	4.0	5 1/8	8 1/2
GF365R	5.0	5 1/8	8 1/2
GF370R	1.5	6 1/4	9 5/8
GF371R	2.0	6 1/4	9 5/8
GF372R	2.5	6 1/4	9 5/8
GF373R	3.0	6 1/4	9 5/8
GF374R	4.0	6 1/4	9 5/8
GF375R	5.0	6 1/4	9 5/8
GF380R	1.5	7 7/8	11
GF381R	2.0	7 7/8	11
GF382R	2.5	7 7/8	11
GF383R	3.0	7 7/8	11
GF384R	4.0	7 7/8	11
GF385R	5.0	7 7/8	11



INCHES

Neurosurgery

Suction Cannulas



Diam. 4 mm

Olive Diam. 9 mm

GF917R

ADSON Suction Tube

Catalog Number	Tip Size (mm)	Tip Size (FR)	Length (in.)
GF917R	4	11	7 1/2

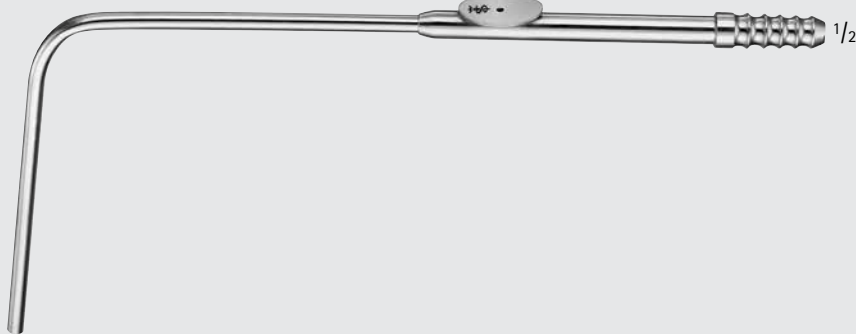

MB635R-MB636R

SACHS Suction Tube

Catalog Number	Tip Size (mm)	Length (in.)
MB635R	SMALL	8 1/2
MB636R	LARGE	8 1/2



FF125R

95 mm, 3 3/4"

1/2

CUSHING-CAIRNS Ventricular Cannula

Catalog Number	Diameter (mm)	Working Length (in.)
FF125R	2.3	3 3/4
FF126R	2.6	3 3/4

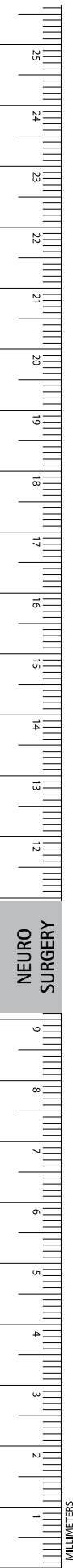

NEURO SURGERY

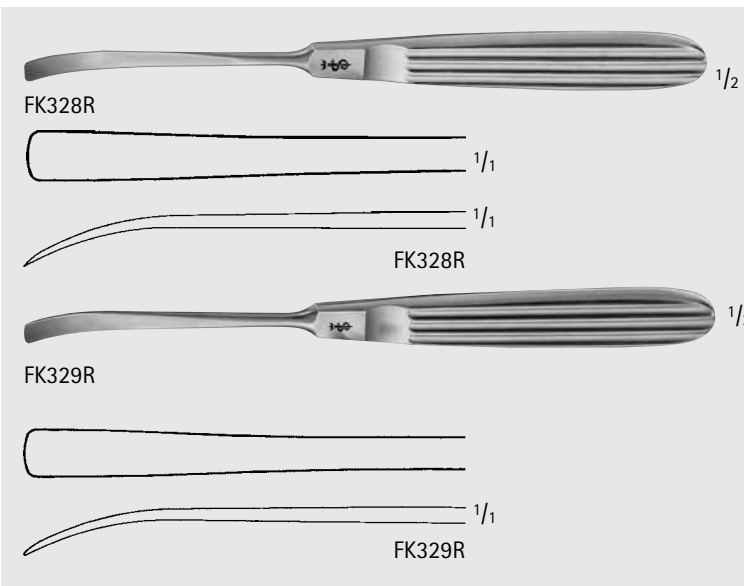

CASPAR Muscle Dissector

Catalog Number	Tip	Width (mm)	Length (in.)
FK328R	SHARP	6.2	7
FK329R	BLUNT	6.2	7

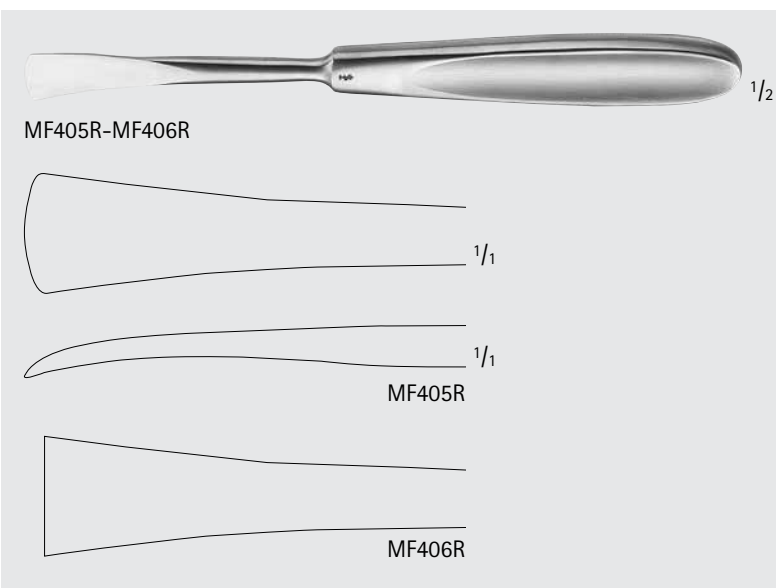

CUSHING Periosteal Elevator

Catalog Number	Tip	Width (mm)	Length (in.)
MF405R	ROUND, SHARP	15	7 1/4
MF406R	SQUARE, SHARP	15	7 1/4

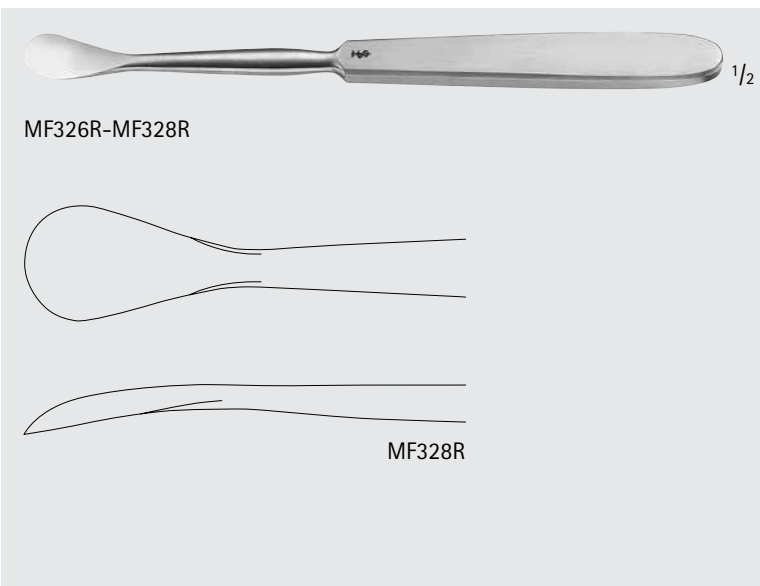

HOEN Periosteal Elevator

Catalog Number	Tip Size (mm)	Length (in.)
MF326R	7.0	7 1/4
MF327R	15.0	7 1/4
MF328R	20.0	7 1/4

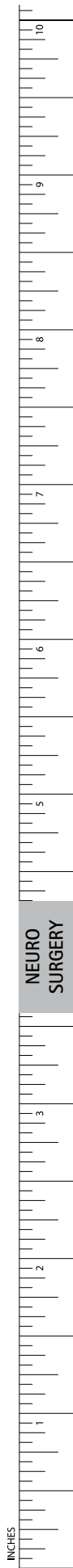

NEURO SURGERY

INCHES

Neurosurgery

Retractors and Handrest Systems



MF139R-MF141R

SCOVILLE Nerve Root Retractor

Catalog Number	Shape	Width (mm)	Working Length (in.)
MF139R	45°	8.0	4
MF140R	90°	8.0	4
MF141R	STR	8.0	7 1/4

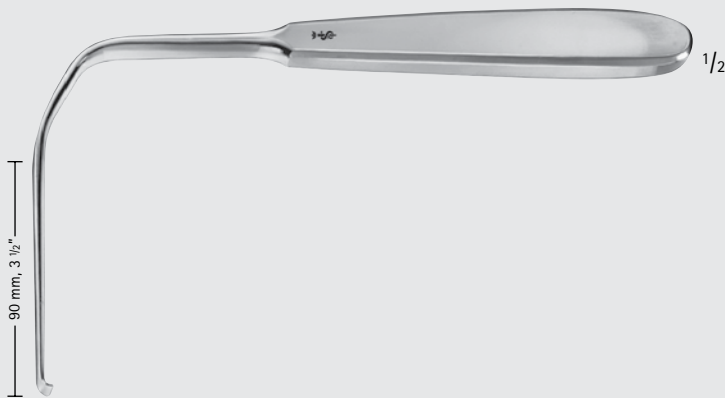

FF707R-FF709R

HESS Nerve Root Retractor

Catalog Number	Width (mm)	Working Length (in.)	Length (in.)
FF707R	3.0	3 1/2	6 7/8
FF708R	5.0	3 1/2	6 7/8
FF709R	7.0	3 1/2	6 7/8

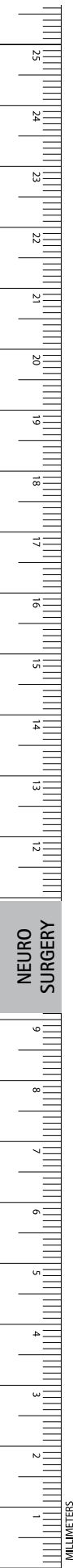



FF700R 1/2

FF700R 1/2

FF700R 1/1

Catalog Number	Length (in.)
FF700R	8 1/4

FF701R-FF703R 1/2

Catalog Number	Shape	Length (in.)
FF701R	STR	8 3/4
FF702R	45°	8 3/4
FF703R	90°	8 3/4

MF401R 1/2

MF401R 1/1

Catalog Number	Tip	Length (in.)
MF401R	ANG	8 1/4

MF402R-MF404R 1/2

Catalog Number	Tip	Blade	Length (in.)
MF402R	ANG	TOOTHED	8 1/2
MF403R	ANG	PLAIN	8 1/2
MF404R	ANG, SHARP	HOOK	8 1/2

Neurosurgery

Retractors and Handrest Systems

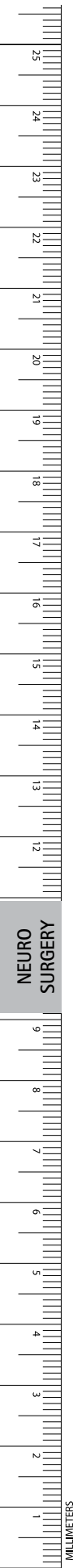

MF057R

**D'ERRICO Nerve Root Retractor,
Bayonet-Shaped**

Catalog Number	Length (in.)
MF057R	9

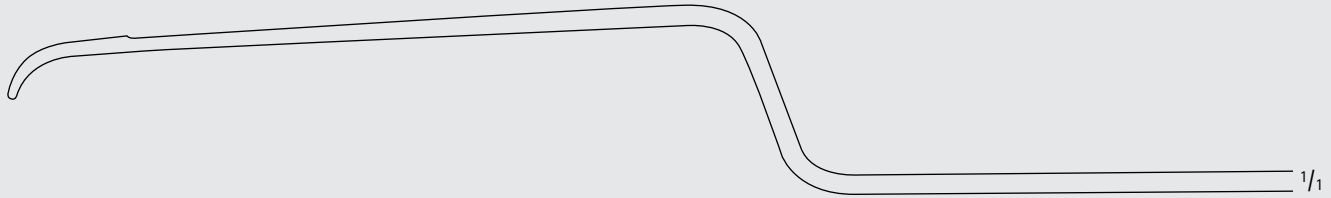

MF057R



FF697R-FF710R

CASPAR Nerve Root Retractor

Catalog Number	Width (mm)	Length (in.)
FF697R	4.0	9 1/2
FF699R	6.0	9 1/2
FF710R	8.0	9 1/2
FF698R	10.0	9 1/2

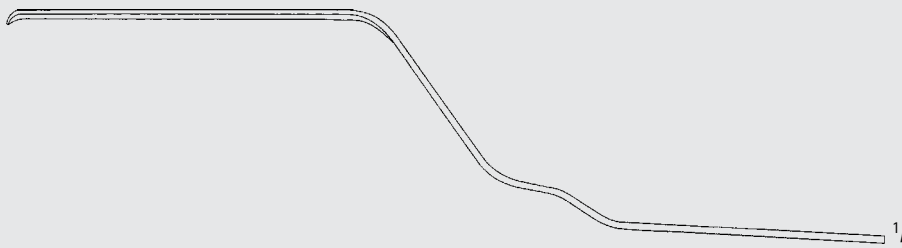

FF697R-FF710R



FF280R-FF286R

**Ball and Socket Joint, F/ Holding Rod
FF285R**

Catalog Number	Size (mm)
FF280R	10 x 25
FF286R	9 x 32



FF285R

**Holding Rod, F/ Ball and Socket Joint
FF280R**

Catalog Number	Compatible w/
FF285R	FF282R, FF283R or FF284R



FF282R

**Coupling Head, F/ Up to 5 Flexible
Arms FF270R**

Catalog Number
FF282R



FF283R

**Coupling Head, F/ Flexible Arm FF270R,
Rotatable**

Catalog Number
FF283R

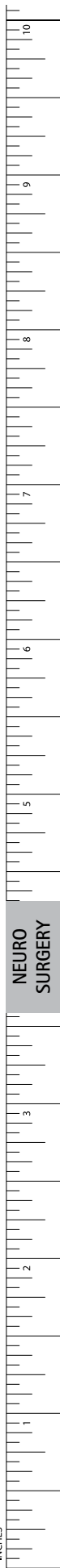

Neurosurgery

Retractors and Handrest Systems

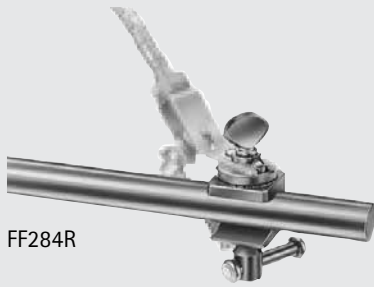

Coupling Head, F/ Flexible Arm FF270R,
Rotatable, Laterally Open

Catalog Number
FF284R

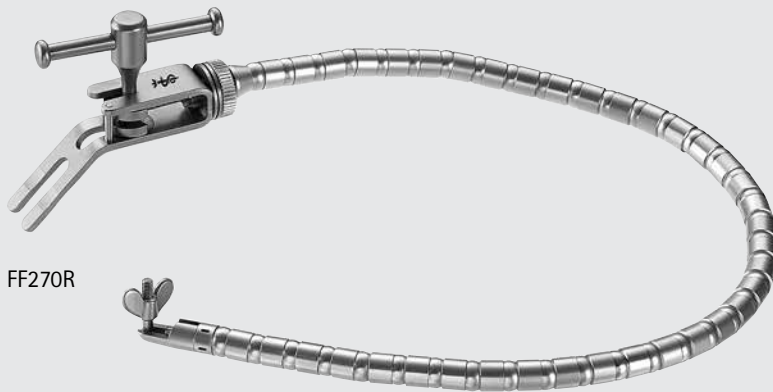

YASARGIL Flexible Arm

Catalog Number	Description
FF270R	COUPLING HEADS: FF282R, FF283R, FF284R FIXATION BASES: FF266R, FF267R, FF268R



Support for Brain Spatula, F/ Flexible
Arm FF270R

Catalog Number
FF273R



Support for Brain Spatula, W/ Round
Shaft, F/ Flexible Arm FF270R

Catalog Number
FF274R

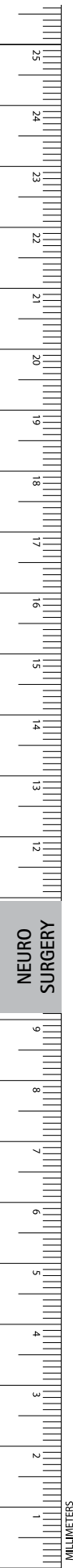

NEURO SURGERY

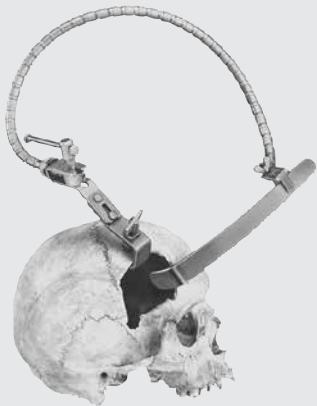

FF260R

YASARGIL Self-Retaining Retractor, W/ 1 Flexible Arm

Catalog Number
FF260R

FF260R Includes:

- 1 Fixation base FF266R,
- 1 Flexible arm FF270R and
- 1 Support for brain spatula FF273R

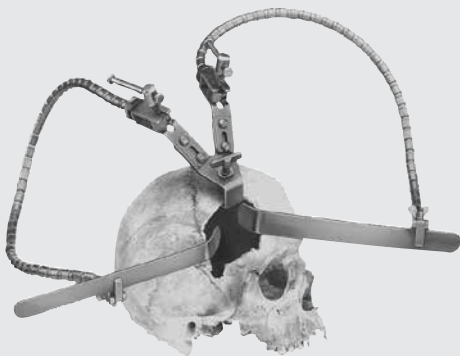

FF262R

YASARGIL Self-Retaining Retractor, W/ 2 Flexible Arms

Catalog Number
FF262R

FF262R Includes:

- 1 Fixation base FF268R,
- 2 Flexible arms FF270R and
- 2 Supports for brain spatulas FF273R



FF266R

Fixation Base, F/ Skull Mounting, Holds 1 Flexible Arm FF260R

Catalog Number
FF266R

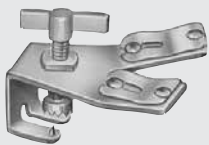

FF268R

Fixation Base, F/ Skull Mounting, Hold 2 Flexible Arms FF270R

Catalog Number
FF268R

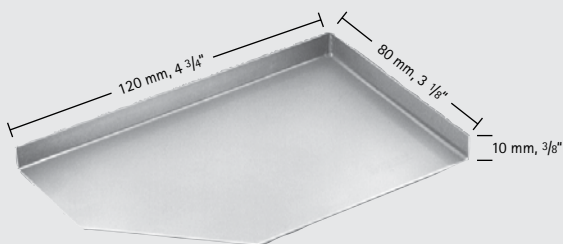

FF180R

Utility Tray

Catalog Number	Compatible w/	Width (in.)	Length (in.)
FF180R	FLEXIBLE ARMS FF270R AND FF273R	3 1/8	4 3/4



Neurosurgery

Retractors and Handrest Systems

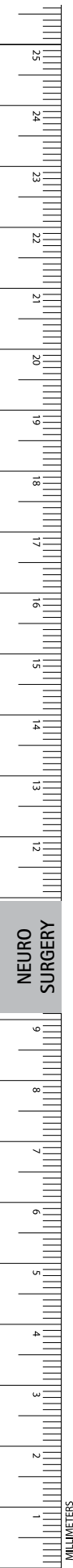

NEW JERSEY Flexible Arm

Catalog Number
FF431R

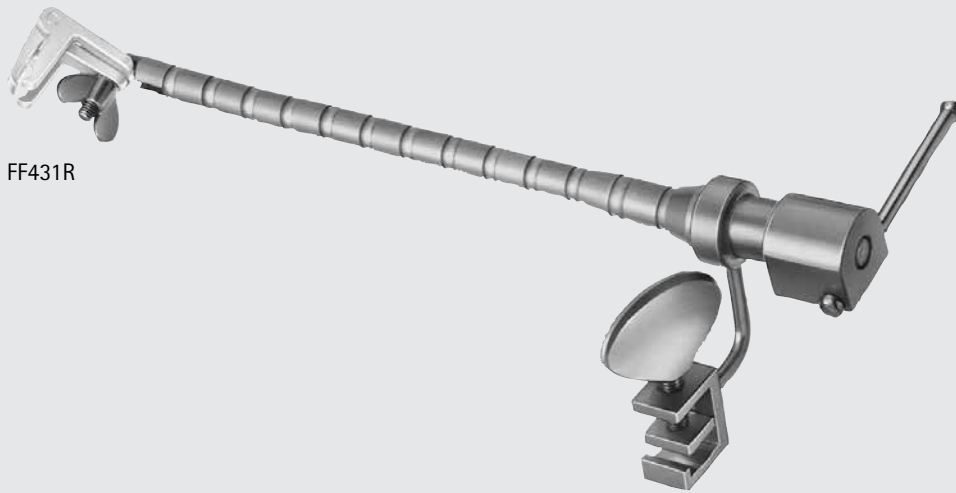

FF431R

Table Attachment

Catalog Number	Compatible w/
FF151R	FF150R



FF151R

GILSBACH Basic Unit

Catalog Number	Description
FF150R	COMPLETE BASIC UNIT
FF152R	GILSBACH INSULATING HOLDING ROD
FF153R	GILSBACH SEMI-CIRCULAR BASIC BAR
FF154R	FRAME FOR GALEA HOOK

FF150R Includes:

- 1 Insulated holding rod FF152R
- 1 Semi-circular basic bar FF153R
- 1 Frame FF154R for Galea hook

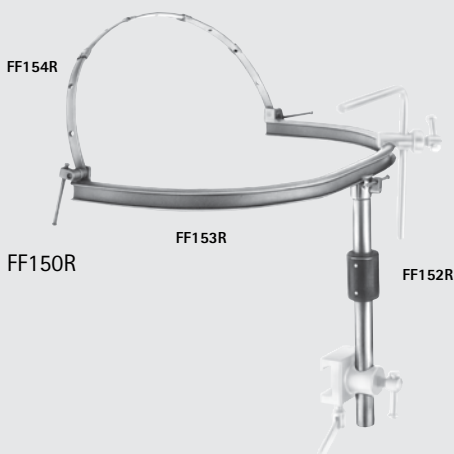

FF154R

FF150R

FF153R

FF152R

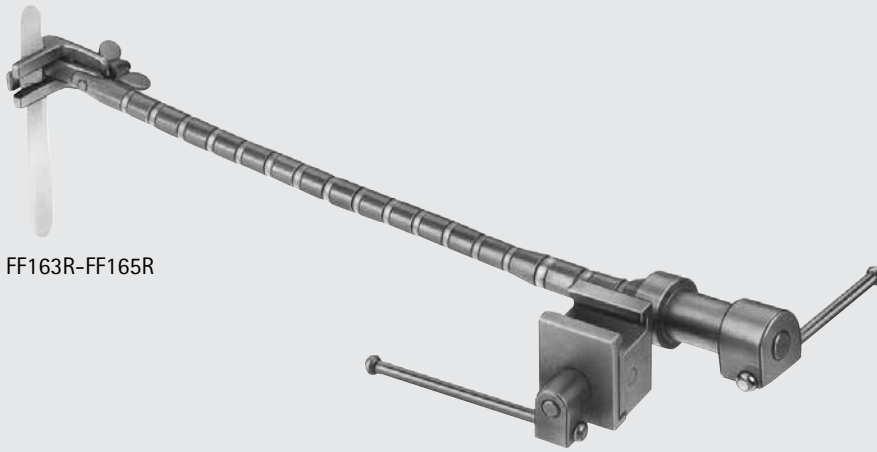

GILSBACH Flexible Arm

Catalog Number	Length (in.)
FF163R	7 7/8
FF165R	9 3/4

FF163R-FF165R



Forceps Holder

Catalog Number	Compatible w/
FF185R	FF153R

FF185R

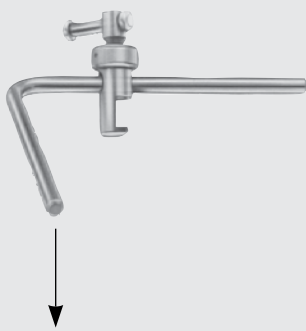

GILSBACH Handrest, Adjustable Height

Catalog Number	Compatible w/
FF187R	FF153R

FF187R



NEURO SURGERY

INCHES

Neurosurgery

Retractors and Handrest Systems



GILSBACH Holding Rod, F/ MAYFIELD Head Holder

Catalog Number	Description
FF190R	COMPLETE HOLDING DEVICE
FF191R	HOLDING ROD TO BE FIXED TO MAYFIELD HEAD HOLDER
FF193R	CONNECTION PIECE TO BE MOUNTED TO HOLDING ROD FF191R

FF191R Connection Piece is compatible with FF152R, FF191R and FF285R holding rods

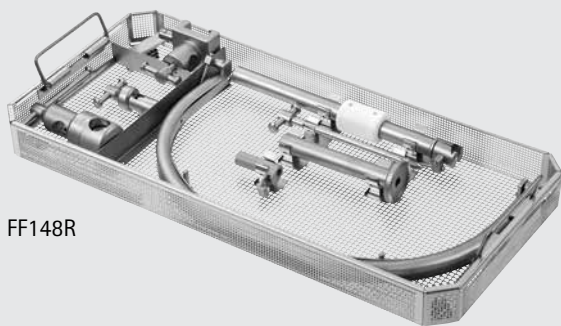

Storage Basket for GILSBACH Basic Unit

Catalog Number	Dimensions (mm)
FF148R	540 x 253 x 56

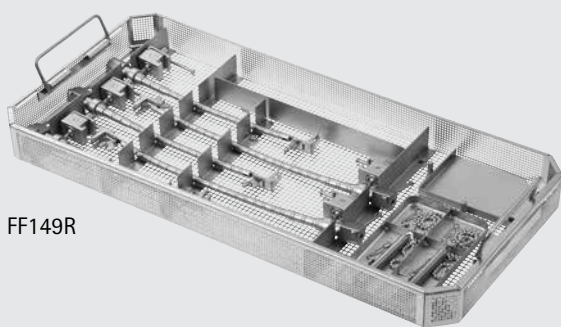

Storage Basket for GILSBACH Flexible Arms

Catalog Number	Dimensions (mm)
FF149R	540 x 254 x 50

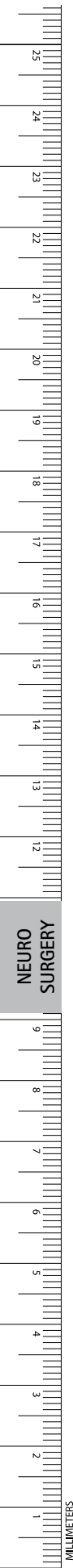

NEURO SURGERY



FF480R-FF488R

Silicone Brain Spatula, Flat, Single Use

Catalog Number	Blade Size (mm)	Packaging	Length (in.)
FF480R	6.0	BOX OF 10	7 7/8
FF482R	7.5	BOX OF 10	7 7/8
FF484R	10.0	BOX OF 10	7 7/8
FF486R	12.5	BOX OF 10	7 7/8
FF488R	15.0	BOX OF 10	7 7/8

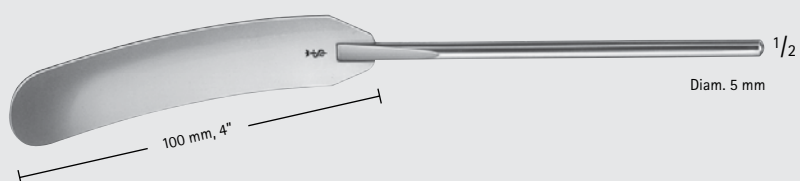

FF231R-FF233R

Malleable Brain Spatula W/ Round Shaft for FF274R

Catalog Number	Working Length (in.)	Blade Size (mm)	Diameter (mm)	Length (in.)
FF231R	4	14	5.0	7 7/8
FF232R	4	17	5.0	7 7/8
FF233R	4	20	5.0	7 7/8



FF256R-FF259R

HEIFETZ Malleable Brain Spatula W/ Round Shaft for FF274R

Catalog Number	Working Length (in.)	Blade Size (mm)	Diameter (mm)	Length (in.)
FF256R	4	8	3.5	6 1/8
FF257R	4	11	3.5	6 1/8
FF258R	4	14	3.5	6 1/8
FF259R	4	17	3.5	6 1/8



NEURO SURGERY

INCHES

Neurosurgery

Brain Spatulas



FF441R-FF446R

AACHEN (MARTIN) Brain Spatula, Malleable

Catalog Number	Blade Size (mm)	Length (in.)
FF441R	7 x 8	7 7/8
FF442R	10 x 11	7 7/8
FF443R	13 x 14	7 7/8
FF444R	16 x 17	7 7/8
FF445R	19 x 20	7 7/8
FF446R	22 x 25	7 7/8



FF201R-FF222R

Brain Spatula, Flat, Malleable

Catalog Number	Blade Size (mm)	Length (in.)
FF201R	9	7 7/8
FF202R	12	7 7/8
FF222R	12	9 3/4



FF211R-FF214R

Brain Spatula, Flat, Malleable

Catalog Number	Blade Size (mm)	Length (in.)
FF211R	7 x 9	7
FF212R	11 x 13	7
FF213R	15 x 18	7
FF214R	18 x 22	7



FF216R-FF217R

OLIVECRONA Brain Spatula, Flat, Malleable

Catalog Number	Blade Size (mm)	Length (in.)
FF216R	7 x 9	7
FF217R	11 x 13	7

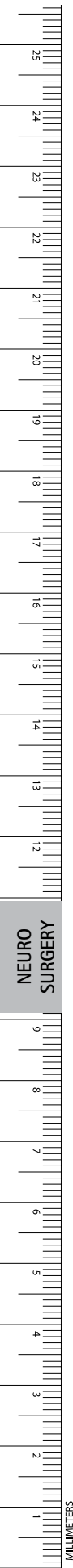



MD111-MD116

DAVIS Brain Spatula, Flat, Malleable

Catalog Number	Blade Size (mm)
MD111	6.0
MD112	9.0
MD113	13.0
MD114	16.0
MD115	19.0
MD116	25.0



MF348R-MF355R

Silicone Coated Brain Spatula, Post

Catalog Number	Blade Size (mm)	Length (in.)
MF348R	6.0	5 3/4
MF350R	8.0	5 3/4
MF349R	10.0	5 3/4
MF352R	11.0	5 3/4
MF354R	14.0	5 3/4
MF351R	15.0	5 3/4
MF353R	20.0	5 3/4
MF355R	25.0	5 3/4

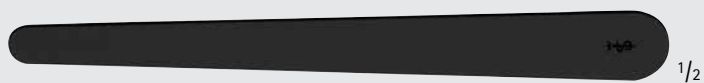

MF356R-MF359R

Silicone Coated Brain Spatula

Catalog Number	Blade Size (mm)	Length (in.)
MF356R	10 x 6	6 3/4
MF357R	15 x 8	6 3/4
MF358R	20 x 11	6 3/4
MF359R	25 x 14	6 3/4

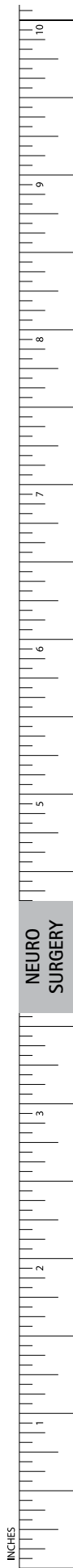

Neurosurgery

