





## General Surgery

Scissors .....	2 - 52
Needle Holders and Cases .....	53 - 76
Ligature Needles .....	77 - 78
Forceps and Clamps .....	79 - 189
Skin Hooks .....	190 - 192
Retractors .....	193 - 254
Universal Ring Retractor System .....	255 - 271
Self Retaining Retractors .....	272 - 283
Rectal Specula Instruments .....	284 - 291
Probes, Dilators and Scoops .....	292 - 299
Scalpel Blades and Handles .....	300 - 307
Amputation and Autopsy Instruments .....	308 - 310
Suction Instruments .....	311 - 322
Rulers, Calipers and Accessories .....	323 - 324
Metal Bowls and Cups .....	325

# General Surgery

## Scissors



BC374R-BC474R

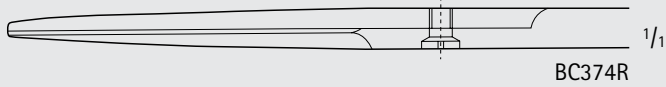

BC374R

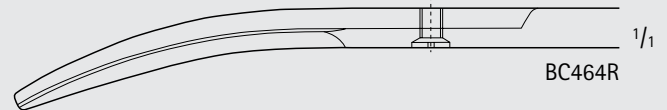

BC464R

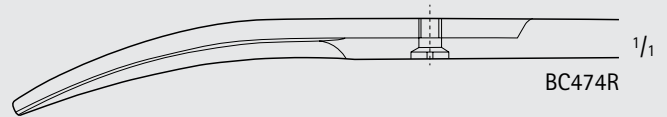

BC474R

### DEAVER Suture Scissors

Catalog Number	Tip	Blade	Length (in.)
BC374R	S/B	STR	5 3/4
BC474R	S/B	CVD	5 3/4
BC464R	B/B	CVD	5 3/4



BC130R-BC131R

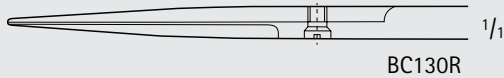

BC130R

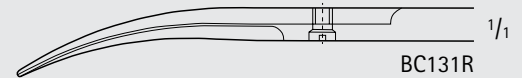

BC131R



BC341R-BC346R

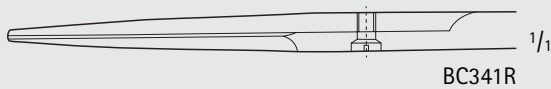

BC341R

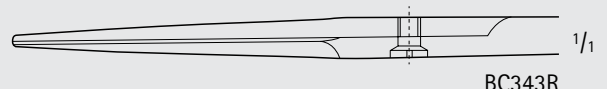

BC343R

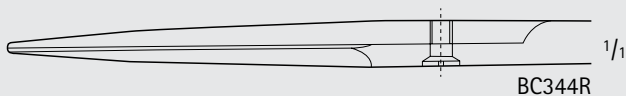

BC344R



BC345R

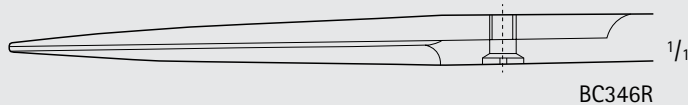

BC346R

### Suture Scissors

Catalog Number	Tip	Blade	Length (in.)
BC130R	S/S	STR	4 3/4
BC341R	S/S	STR	4 1/2
BC343R	S/S	STR	5 1/8
BC344R	S/S	STR	5 3/4
BC345R	S/S	STR	6
BC346R	S/S	STR	6 1/2
BC131R	S/S	CVD	4 3/4



BC441R-BC445R

Suture Scissors

Catalog Number	Tip	Blade	Length (in.)
BC441R	S/S	CVD	4 1/2
BC443R	S/S	CVD	5 1/8
BC444R	S/S	CVD	5 3/4
BC445R	S/S	CVD	6

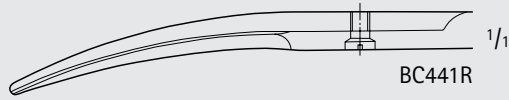

BC441R

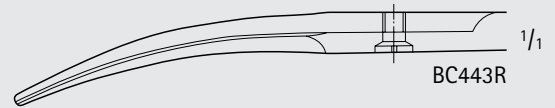

BC443R

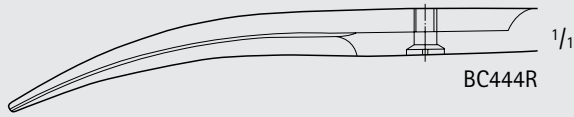

BC444R



BC445R



BC303R-BC304R

Suture Scissors

Catalog Number	Tip	Blade	Length (in.)
BC303R	S/B	DEL, STR	5 1/8
BC304R	S/B	DEL, STR	5 3/4

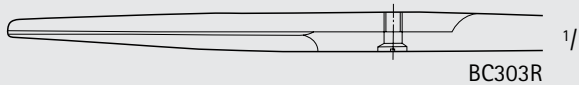

BC303R

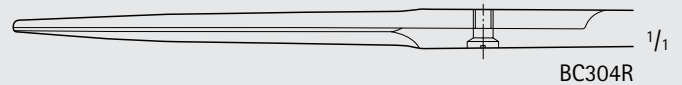

BC304R



BC496R

Scissors

Catalog Number	Tip	Blade	Length (in.)
BC496R	S/B	STR/1-SERR	5 1/8

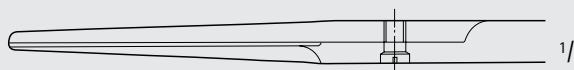

BC496R



# General Surgery

## Scissors

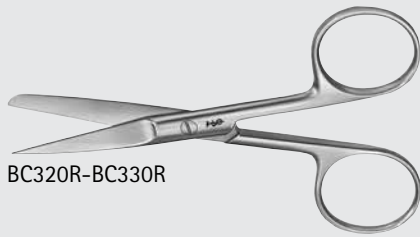

BC320R-BC330R

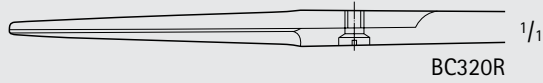

BC320R

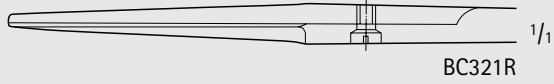

BC321R

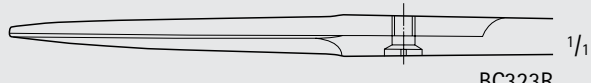

BC323R

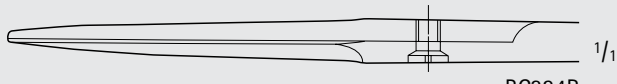

BC324R

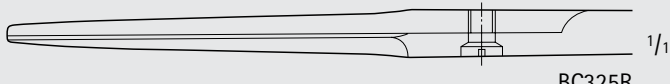

BC325R

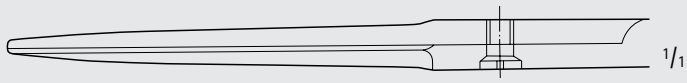

BC326R

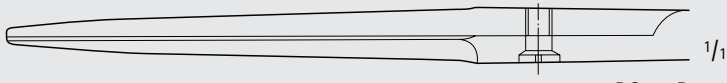

BC327R

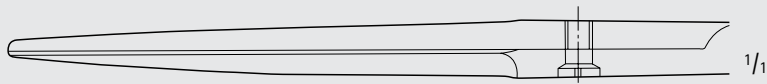

BC328R

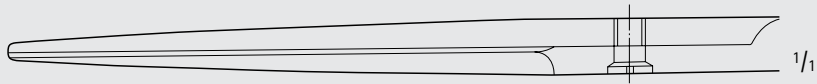

BC330R

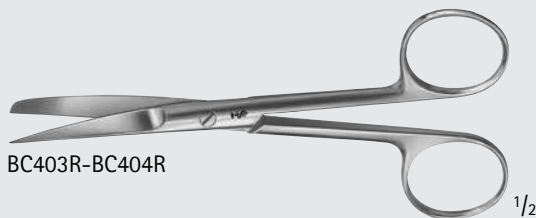

BC403R-BC404R

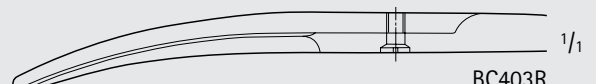

BC403R

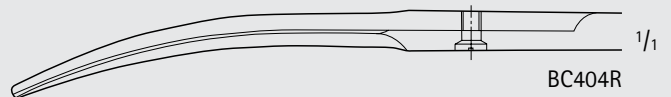

BC404R

### Suture Scissors

Catalog Number	Tip	Blade	Length (in.)
BC320R	S/B	STR	4 1/8
BC321R	S/B	STR	4 1/2
BC323R	S/B	STR	5 1/8
BC324R	S/B	STR	5 3/4
BC325R	S/B	STR	6
BC326R	S/B	STR	6 1/2
BC327R	S/B	STR	6 7/8
BC328R	S/B	STR	7 1/4
BC330R	S/B	STR	7 7/8
BC403R	S/B	CVD	5 1/8
BC404R	S/B	CVD	5 3/4



BC421R-BC428R

Suture Scissors

Catalog Number	Tip	Blade	Length (in.)
BC421R	S/B	CVD	4 1/2
BC423R	S/B	CVD	5 1/8
BC424R	S/B	CVD	5 3/4
BC425R	S/B	CVD	6
BC426R	S/B	CVD	6 1/2
BC428R	S/B	CVD	7 1/4

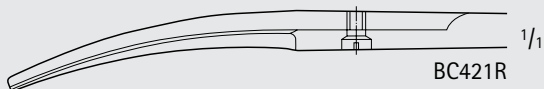

BC421R

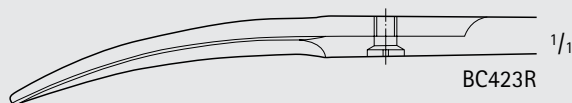

BC423R

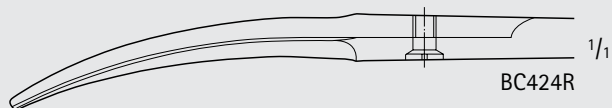

BC424R

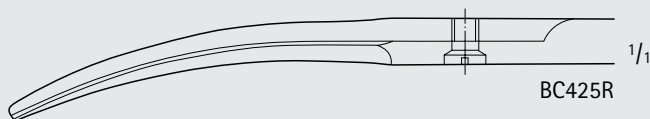

BC425R



BC426R

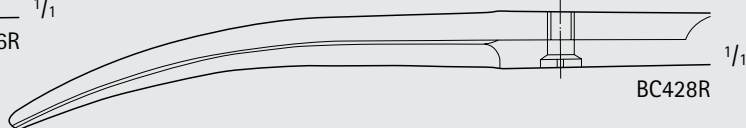

BC428R



BC135R

Suture Scissors

Catalog Number	Tip	Blade	Length (in.)
BC135R	B/B	CVD, DEL	4 3/4

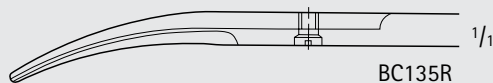

BC135R



# General Surgery

## Scissors



BC313R-BC317R

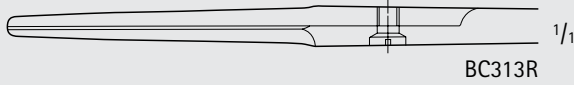

BC313R

1/1

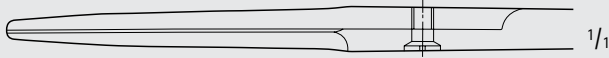

BC314R

1/1



BC315R

1/1

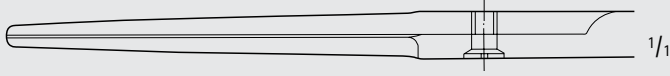

BC316R

1/1

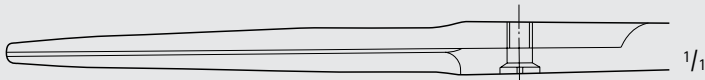

BC317R

1/1



BC411R-BC417R

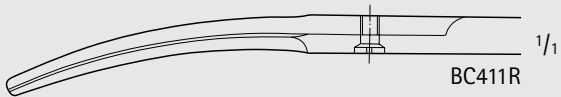

BC411R

1/1

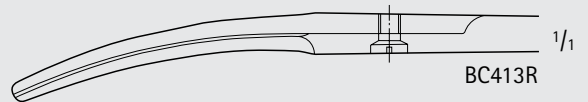

BC413R

1/1

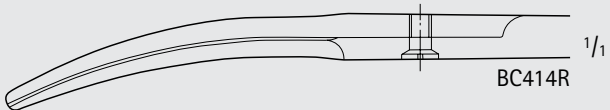

BC414R

1/1

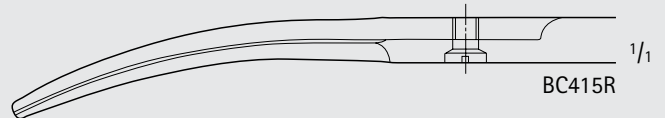

BC415R

1/1

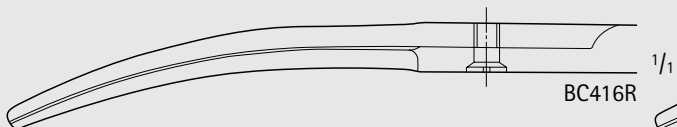

BC416R

1/1

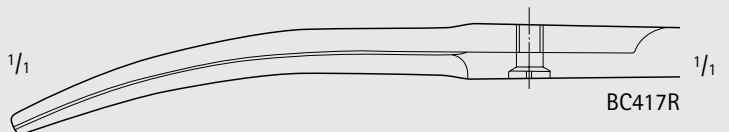

BC417R

1/1

### COOPER Suture Scissors

Catalog Number	Tip	Blade	Length (in.)
BC313R	B/B	STR	5 1/8
BC314R	B/B	STR	5 3/4
BC315R	B/B	STR	6
BC316R	B/B	STR	6 1/2
BC317R	B/B	STR	6 7/8
BC411R	B/B	CVD	4 1/2
BC413R	B/B	CVD	5 1/8
BC414R	B/B	CVD	5 3/4
BC415R	B/B	CVD	6
BC416R	B/B	CVD	6 1/2
BC417R	B/B	CVD	6 7/8

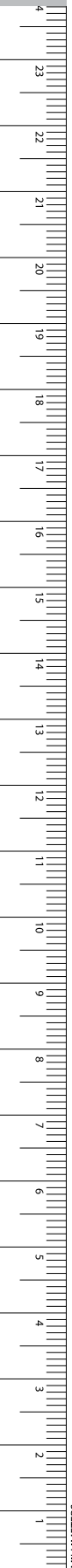



LITTAUER Ligature Scissors

Catalog Number	Tip	Blade	Length (in.)
BC803R	B/1-NOTCH	STR	5 1/4

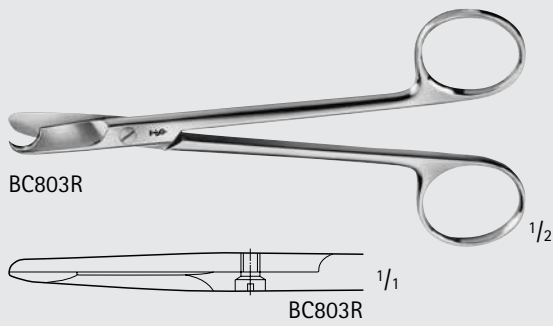

NORTHBENT Ligature Scissors

Catalog Number	Tip	Blade	Length (in.)
BC805R	B/1-NOTCH	LAT-CVD	4 3/4

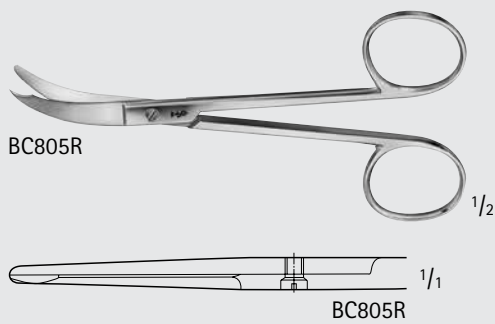

SPENCER Suture Scissors

Catalog Number	Tip	Blade	Length (in.)
BC801R	B/1-NOTCH	STR	3 1/2
BC802R	B/1-NOTCH	STR	4 1/2

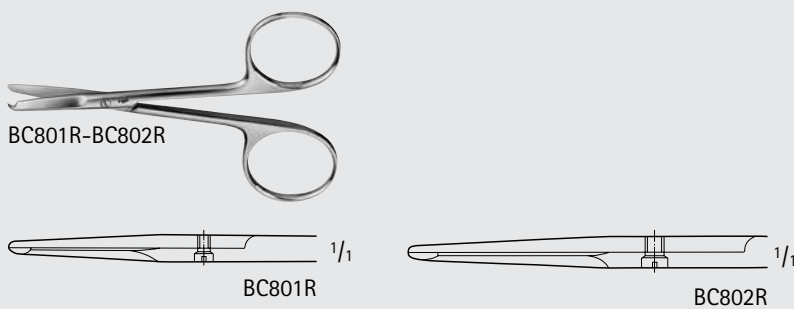

KNOWLES Bandage Scissors

Catalog Number	Tip	Blade	Length (in.)
BC846R	1-PROBE-POINT	STR	5 3/4
BC847R	1-PROBE-POINT	LAT-ANG	5 1/2

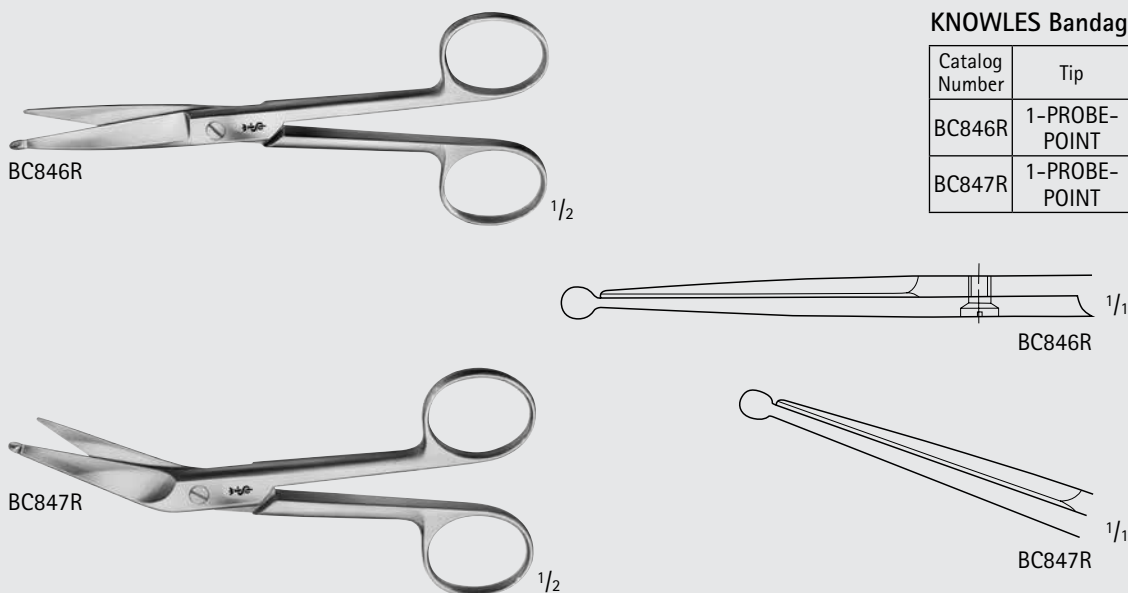

# General Surgery

## Scissors



BC848R-BC863R

### LISTER Bandage Scissors

Catalog Number	Blade	Length (in.)
BC848R	LONG	6 1/8
BC849R	LONG	7
BC860R	STANDARD	4 1/2
BC861R	STANDARD	5 1/2
BC862R	STANDARD	7
BC863R	STANDARD	7 7/8

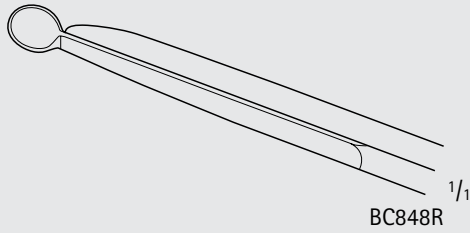

BC848R

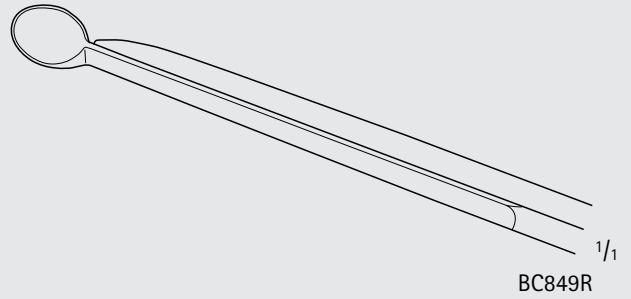

BC849R

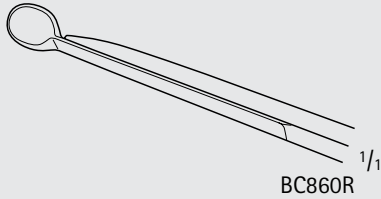

BC860R

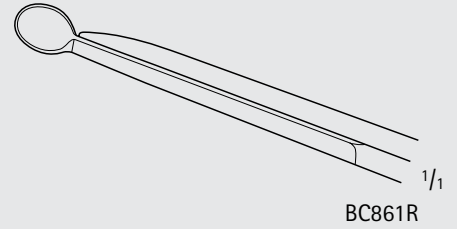

BC861R

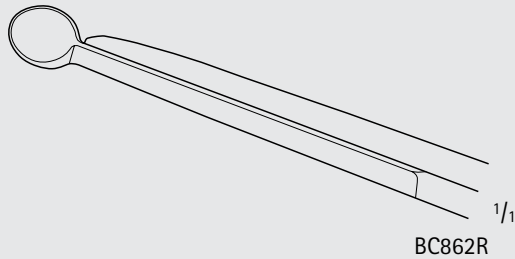

BC862R

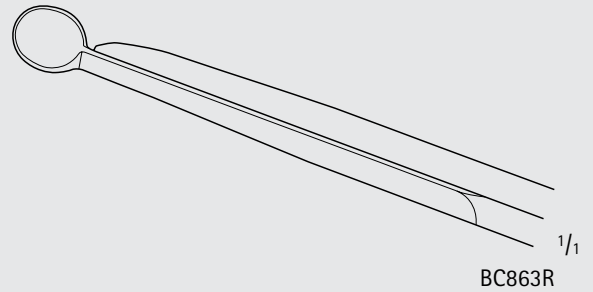

BC863R



MG379R

### LISTER Bandage Scissors, Gold Handle

Catalog Number	Length (in.)
MG379R	5 1/2

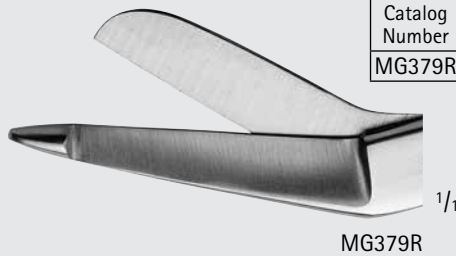

MG379R



MB223

**LISTER Bandage Scissors, W/ One Large Ring**

Catalog Number	Length (in.)
MB223	8



MB223



BC876R, MB146R

**LISTER Bandage Scissors, Serrated**

Catalog Number	Length (in.)
MB146R	3 1/2
BC876R	6 1/4

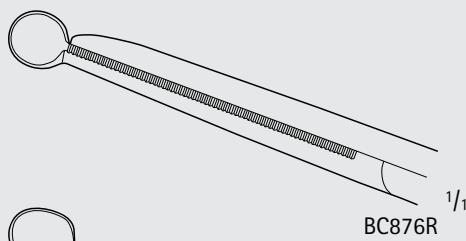

BC876R

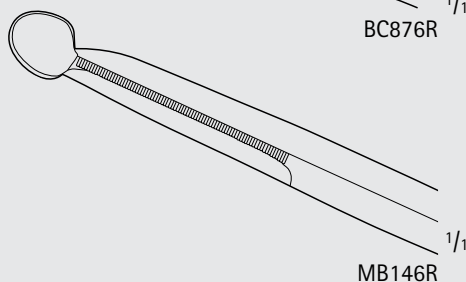

MB146R



# General Surgery

## Scissors



BC890R

1/2

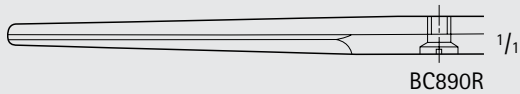

BC890R

1/1

### Nurse's Bandage Scissors

Catalog Number	Tip	Blade	Handle Color	Length (in.)
BC890R	B/B	STR	RED	5 3/4



BC885R-BC979R

1/2

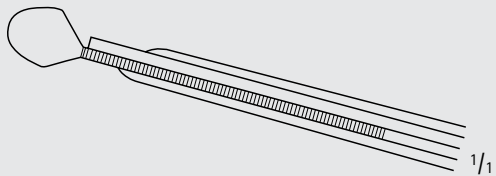

BC885R-BC979R

1/1

### LISTER Universal Bandage Scissors, Serrated

Catalog Number	Handle Color	Length (in.)
BC885R	BLACK	5 3/4
BC970R	RED	5 3/4
BC971R	BLUE	5 3/4
BC973R	YELLOW	5 3/4
BC975R	ORANGE	5 3/4
BC977R	PINK	5 3/4
BC978R	LIGHT GREEN	5 3/4
BC979R	VIOLET	5 3/4



BC881R-BC989R

1/2

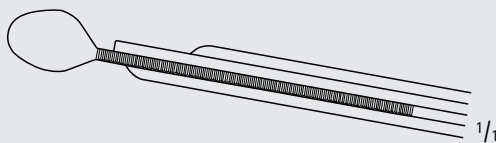

BC881R-BC989R

1/1

### Universal Bandage Scissors, W/ One Large Ring, Serrated

Catalog Number	Handle Color	Length (in.)
BC881R	BLACK	7
BC980R	RED	7
BC981R	BLUE	7
BC983R	YELLOW	7
BC985R	ORANGE	7
BC987R	PINK	7
BC988R	LIGHT GREEN	7
BC989R	VIOLET	7

**STILLE Dissecting Scissors, Round Blades**

Catalog Number	Tip	Blade	Length (in.)
BC580R	B/B	STR	6
BC581R	B/B	CVD	6

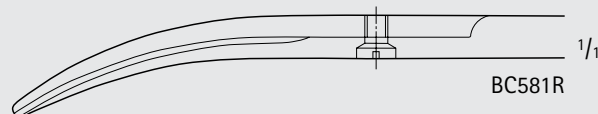
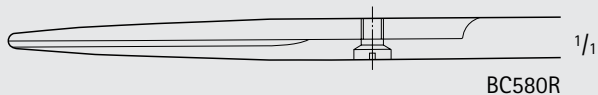

**MAYO Dissecting Scissors, Round Blade**

Catalog Number	Tip	Blade	Length (in.)
BC584R	B/B	STR	6 1/2
BC585R	B/B	STR	7 7/8
BC587R	B/B	CVD	6 1/2
BC588R	B/B	CVD	7 7/8
BC589R	B/B	CVD	8 1/4

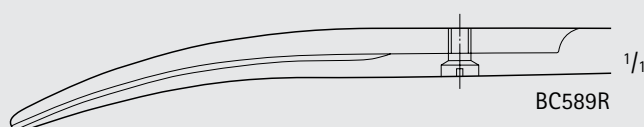
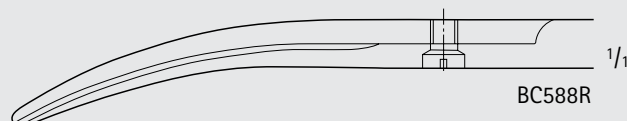
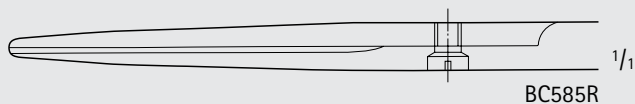
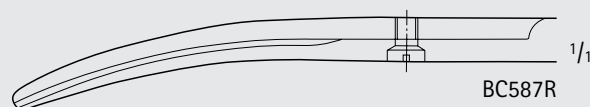
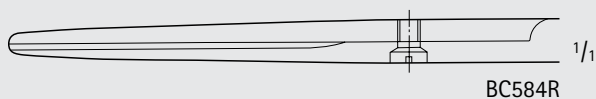

# General Surgery

## Scissors



BC560R-BC561R  $\frac{1}{3}$

BC560R  $\frac{1}{1}$

BC561R  $\frac{1}{1}$

MAYO-HARRINGTON Dissecting Scissors			
Catalog Number	Tip	Blade	Length (in.)
BC560R	B/B	STR	9
BC561R	B/B	CVD	9

BC567R-BC568R  $\frac{1}{3}$

BC568R  $\frac{1}{1}$

BC567R  $\frac{1}{1}$

MAYO-HARRINGTON Dissecting Scissors			
Catalog Number	Tip	Blade	Length (in.)
BC568R	B/B	STR	11
BC567R	B/B	CVD	11

MB148R  $\frac{1}{3}$

MB148R  $\frac{1}{1}$

MAYO Dissecting Scissors, W/ One Large Ring			
Catalog Number	Tip	Blade	Length (in.)
MB148R	B/B	HEAVY	14

MAYO Dissecting Scissors, Beveled Blade

Catalog Number	Tip	Blade	Length (in.)
BC544R	B/B	STR	5 1/2
BC545R	B/B	STR	6 1/8
BC547R	B/B	STR	6 3/4
BC562R	B/B	STR	7 1/2
BC564R	B/B	STR	8 1/2
BC554R	B/B	CVD	5 1/2
BC555R	B/B	CVD	6 1/8
BC557R	B/B	CVD	6 3/4
BC563R	B/B	CVD	7 1/2
BC565R	B/B	CVD	8 1/2



BC544R-BC557R

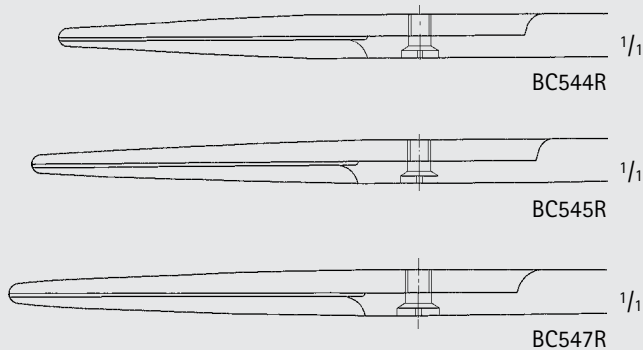

BC544R

BC545R

BC547R

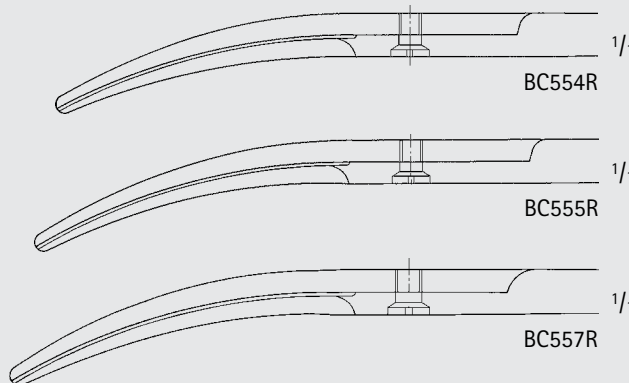

BC554R

BC555R

BC557R



BC562R-BC565R

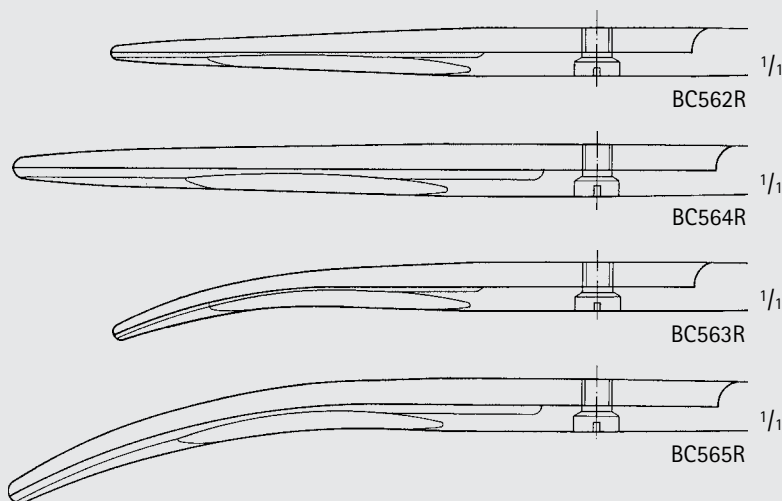

BC562R

BC564R

BC563R

BC565R



INCHES

# General Surgery

## Scissors



BC466R-BC467R  $\frac{1}{2}$

BC466R  $\frac{1}{1}$

BC467R  $\frac{1}{1}$

**MAYO Operating Scissors**

Catalog Number	Tip	Blade	Length (in.)
BC466R	S/S	STR	5 1/2
BC467R	S/S	CVD	5 1/2

BC594R  $\frac{1}{2}$

BC594R  $\frac{1}{1}$

**MAYO Dissecting Scissors, Delicate**

Catalog Number	Tip	Blade	Length (in.)
BC594R	B/B	STR	5 1/2

BC804R  $\frac{1}{2}$

BC804R  $\frac{1}{1}$

**NEW'S Suture Scissors**

Catalog Number	Tip	Blade	Length (in.)
BC804R	B/B	ANG	5 1/2

Suture Scissors

Catalog Number	Tip	Blade	Length (in.)
BC806R	B/B	STR	4 1/2

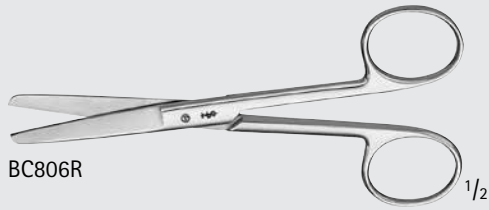

BC806R

1/2

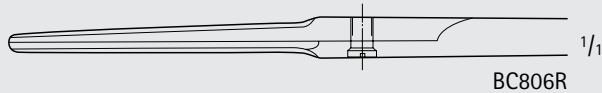

BC806R

1/1

LEXER Dissecting Scissors, Delicate

Catalog Number	Tip	Blade	Length (in.)
BC590R	B/B	STR	6 1/2
BC591R	B/B	CVD	6 1/2



BC590R-BC591R

1/2

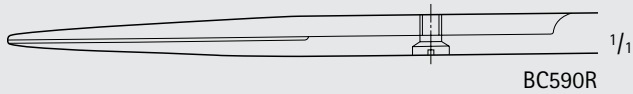

BC590R

1/1

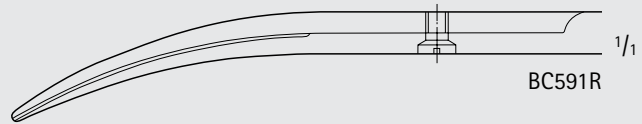

BC591R

1/1

MAYO-LEXER Dissecting Scissors

Catalog Number	Tip	Blade	Length (in.)
BC592R	B/B	CVD	6 1/2

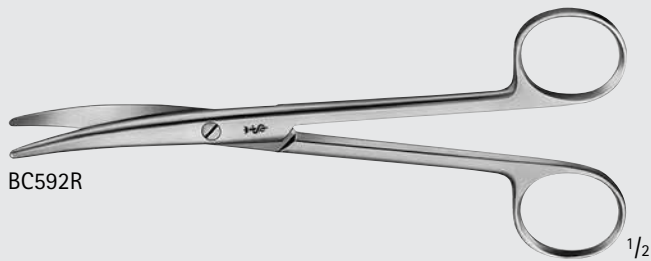

BC592R

1/2

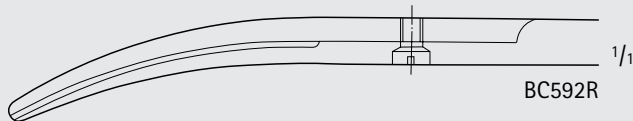

BC592R

1/1

MAYO-SIMS Dissecting Scissors

Catalog Number	Tip	Blade	Length (in.)
MB149R	B/B	STR	7 3/4

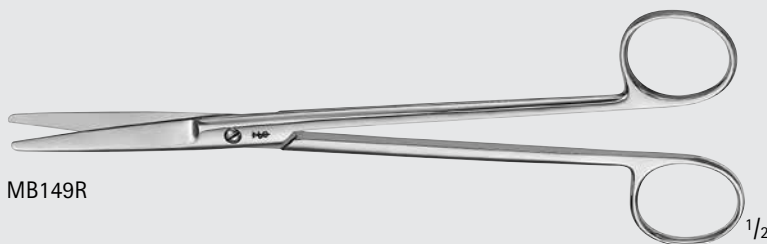

MB149R

1/2

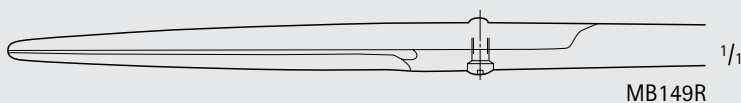

MB149R

1/1



INCHES

# General Surgery

## Scissors



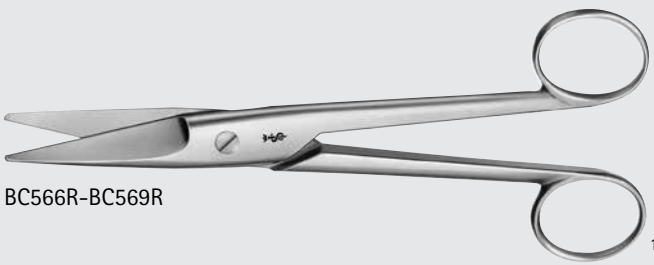

BC566R-BC569R

1/2

**MAYO–NOBLE Dissecting Scissors, Broad Blade**

Catalog Number	Tip	Blade	Length (in.)
BC566R	B/B	STR	6 3/4
BC569R	B/B	CVD	6 3/4

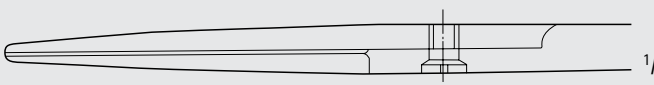

BC566R

1/1

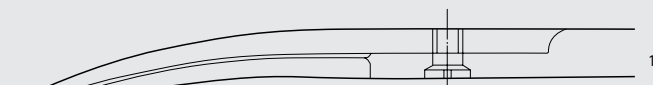

BC569R

1/1



BC576R-BC579R

**MAYO–STILLE Dissecting Scissors, Beveled Blade**

Catalog Number	Tip	Blade	Length (in.)
BC576R	B/B	STR	5 1/2
BC578R	B/B	STR	6 1/2
BC577R	B/B	CVD	5 1/2
BC579R	B/B	CVD	6 1/2

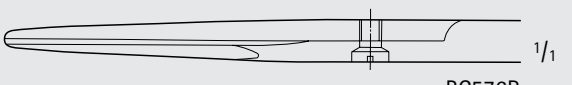

BC576R

1/1

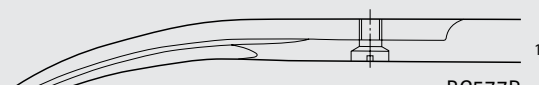

BC577R

1/1

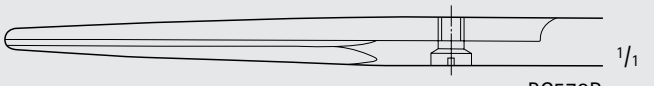

BC578R

1/1

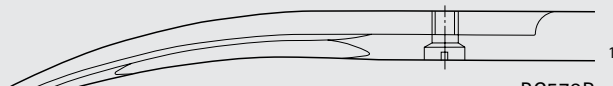

BC579R

1/1



BC570R-BC575R

**MAYO–STILLE Dissecting Scissors, Flat Blade**

Catalog Number	Tip	Blade	Length (in.)
BC570R	B/B	STR	5 1/2
BC572R	B/B	STR	6 3/4
BC573R	B/B	CVD	5 1/2
BC575R	B/B	CVD	6 3/4

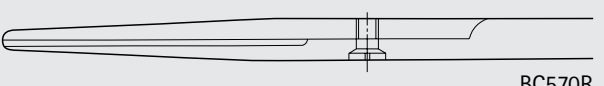

BC570R

1/1

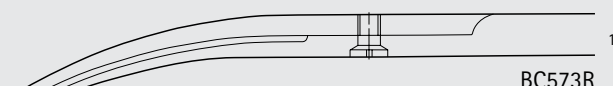

BC573R

1/1

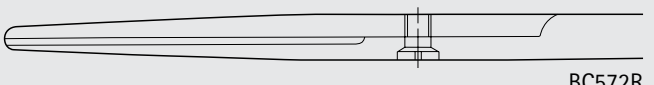

BC572R

1/1

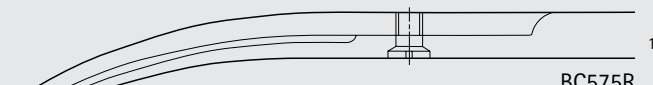

BC575R

1/1

TOENNIS Dissecting Scissors

Catalog Number	Tip	Blade	Length (in.)
BC633R	B/B	X-DEL, STR	7
BC634R	B/B	DEL, STR	7
BC635R	B/B	DEL, CVD	7

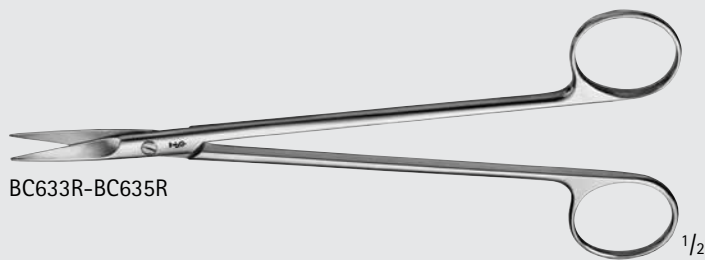

BC633R-BC635R

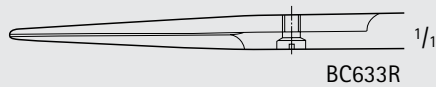

BC633R

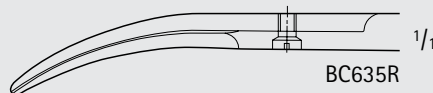

BC635R

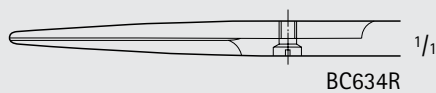

BC634R

Nerve Dissecting Scissors

Catalog Number	Tip	Blade	Length (in.)
BC628R	S/S	CVD	6

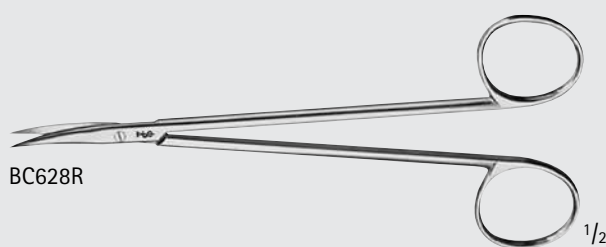

BC628R

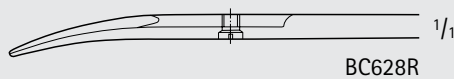

BC628R

TOENNIS-ADSON Dissecting Scissors

Catalog Number	Tip	Blade	Length (in.)
BC630R	X-DEL	CVD	6 7/8
BC631R	DEL	CVD	6 7/8

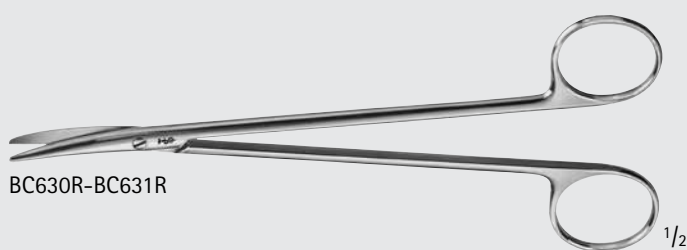

BC630R-BC631R

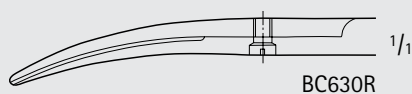

BC630R



BC631R

# General Surgery

## Scissors

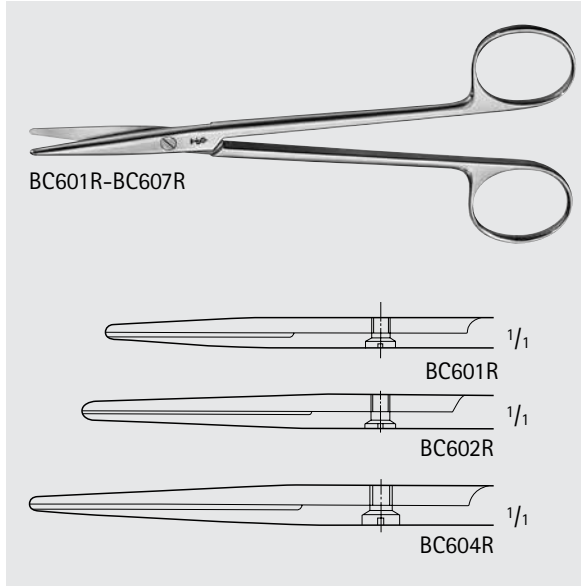
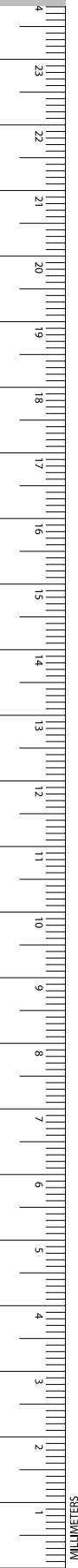

### METZENBAUM Dissecting Scissors

Catalog Number	Tip	Blade	Length (in.)
BC601R	B/B	STR	5 3/4
BC602R	B/B	STR	7
BC604R	B/B	STR	7 7/8
BC605R	B/B	CVD	5 3/4
BC606R	B/B	CVD	7
BC607R	B/B	CVD	7 7/8

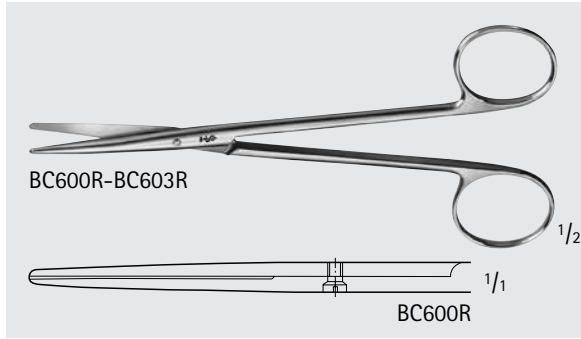
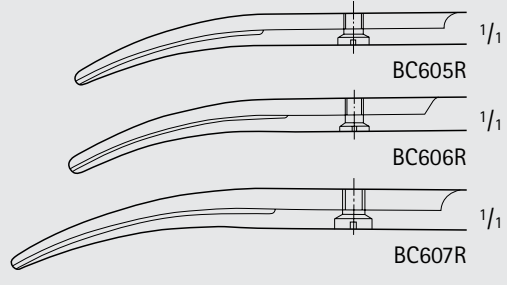

### Baby METZENBAUM Dissecting Scissors, Delicate

Catalog Number	Tip	Blade	Length (in.)
BC600R	B/B	STR	5 3/4
BC603R	B/B	CVD	5 3/4

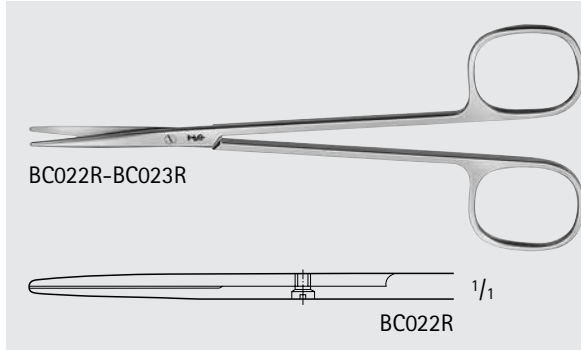
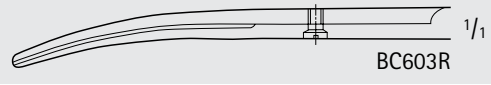

### Baby METZENBAUM Dissecting Scissors

Catalog Number	Tip	Blade	Length (in.)
BC022R	B/B	STR	5 3/4
BC023R	B/B	CVD	5 3/4

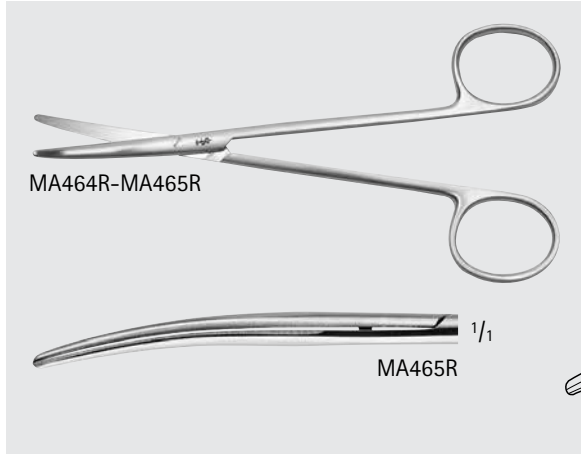
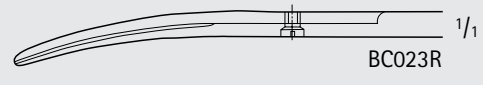

### METZENBAUM Scissors, Delicate

Catalog Number	Tip	Blade	Length (in.)
MA464R	B/B	CVD	5 1/2
MA465R	B/B	CVD	8

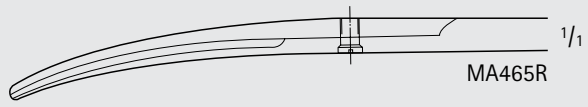

**NELSON-METZENBAUM Dissecting Scissors**

Catalog Number	Tip	Blade	Length (in.)
BC611R	B/B	STR	9
BC612R	B/B	STR	9 3/4
BC613R	B/B	STR	11 1/4
BC614R	B/B	STR	12
BC615R	B/B	CVD	9
BC616R	B/B	CVD	9 3/4
BC618R	B/B	CVD	11 1/4
BC619R	B/B	CVD	12
MB926R	B/B	CVD	16

BC611R-BC619R, MB926R

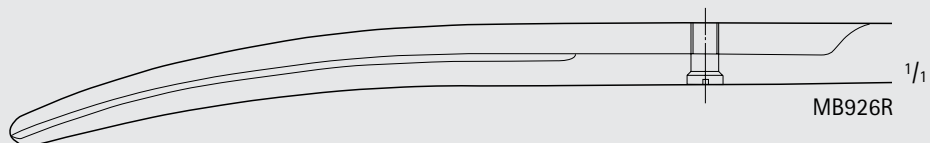
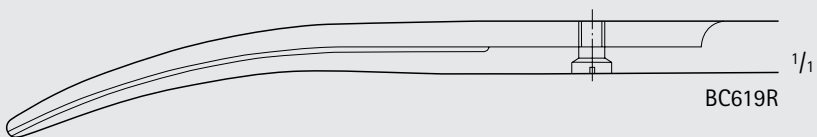
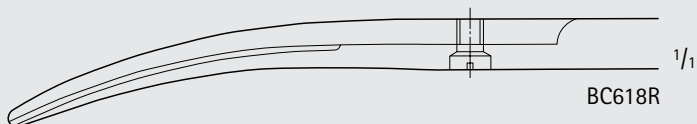
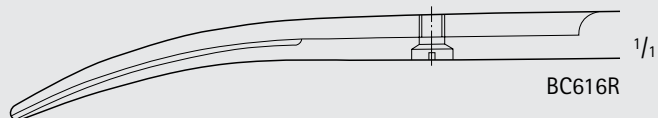
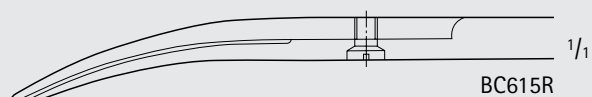
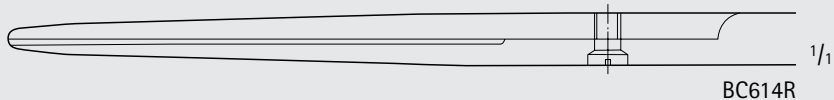
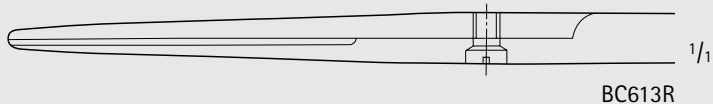
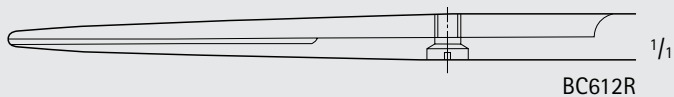
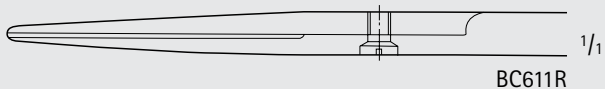
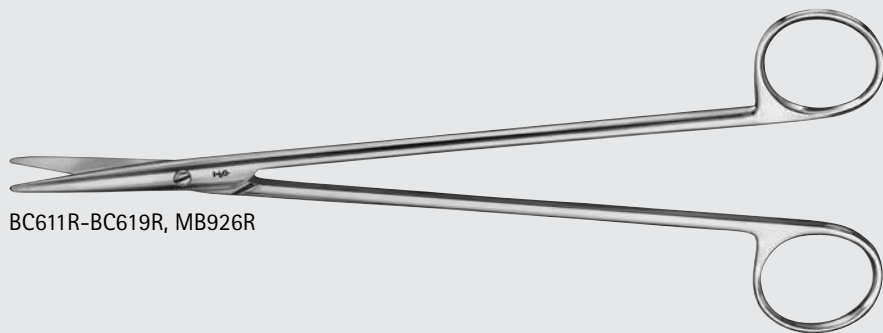

INCHES

General Surgery

Scissors

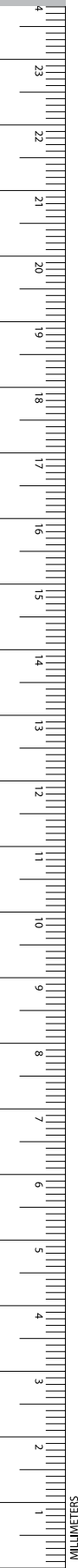

NELSON-METZENBAUM Dissecting Scissors, Delicate

Catalog Number	Tip	Blade	Length (in.)
BC625R	B/B	CVD	13 3/4

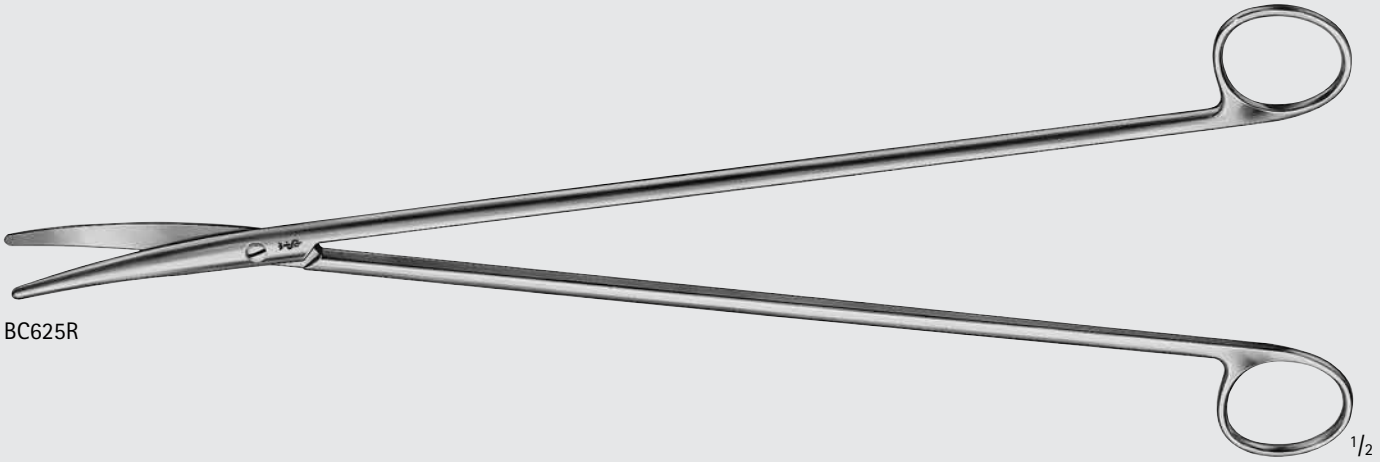

BC625R



BC625R

WELLER Dissecting Scissors

Catalog Number	Tip	Blade	Length (in.)
BC620R	B/B	HEAVY-CVD	11

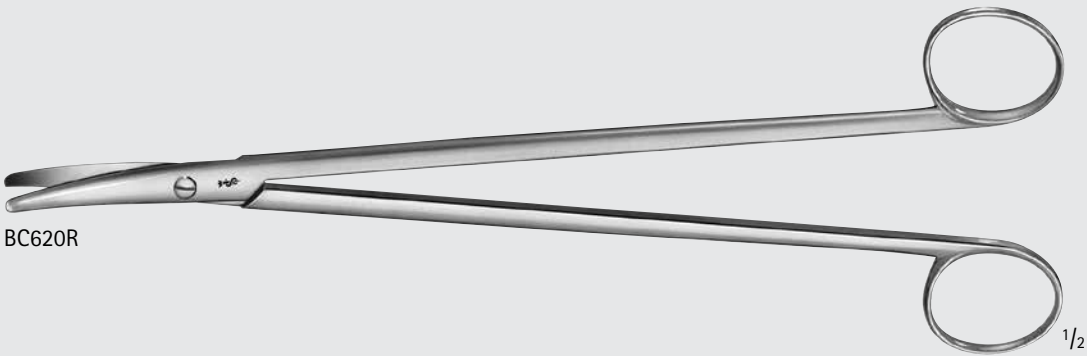

BC620R

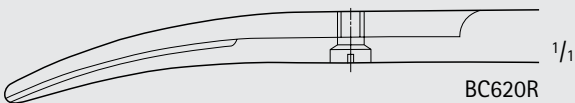

BC620R

Abdominal Scissors

Catalog Number	Tip	Blade	Length (in.)
BC774R	B/B	STR	7



BC774R

1/2

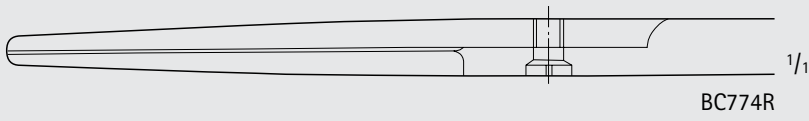

BC774R

1/1

Rectal Scissors

Catalog Number	Tip	Blade	Length (in.)
BC617R	B/B	HEAVY-CVD	12 3/4

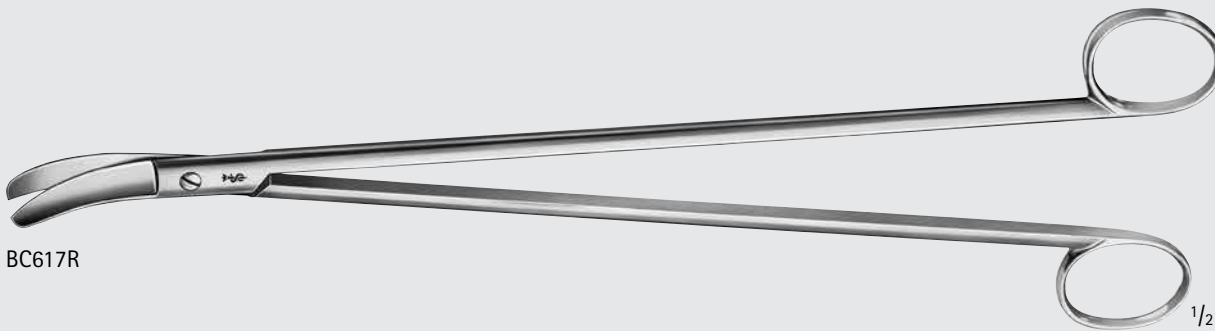

BC617R

1/2

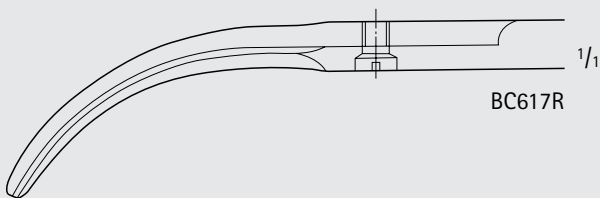

BC617R

1/1



INCHES

# General Surgery

## Scissors

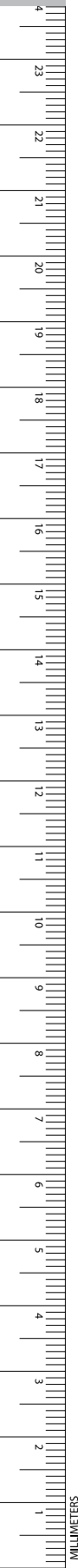

### LLOYD-DAVIES Rectal Scissors

Catalog Number	Tip	Blade	Length (in.)
BC621R	B/B	CVD	10 5/8

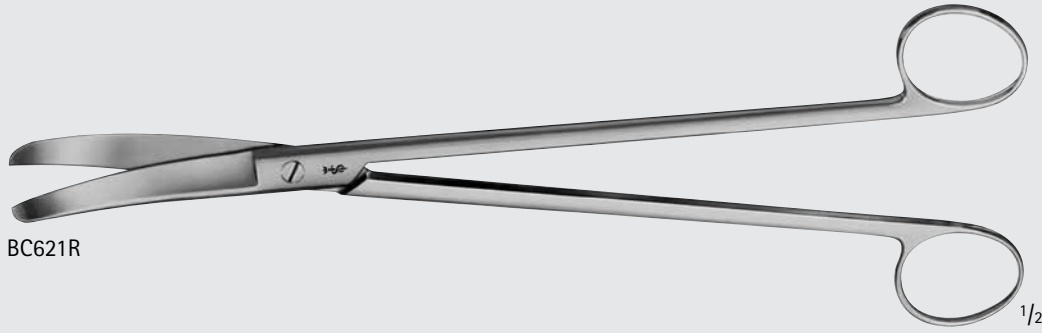

BC621R

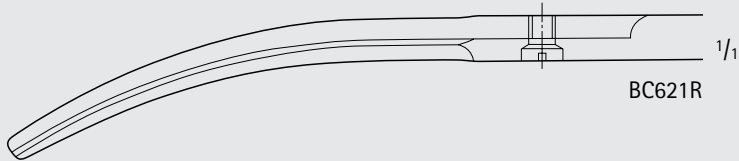

BC621R

### STELZNER Rectal Scissors

Catalog Number	Tip	Blade	Length (in.)
BC622R	B/B	STR	12 1/4
BC623R	B/B	CVD	12 1/4

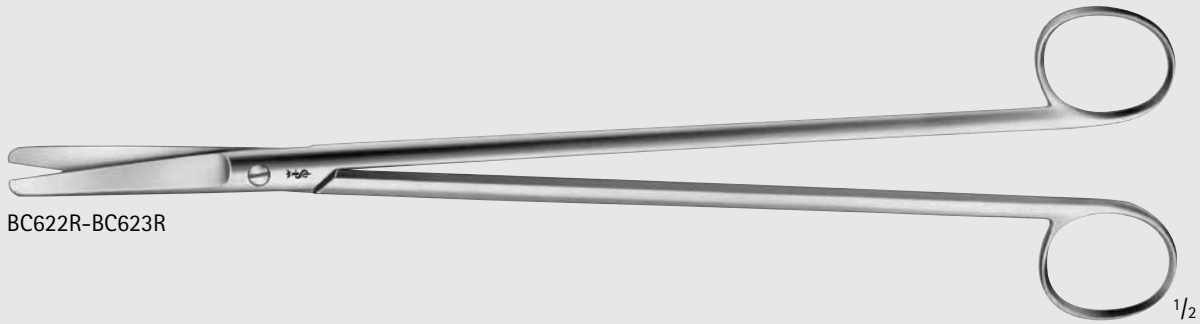

BC622R-BC623R

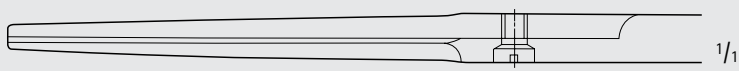

BC622R



BC623R

MUELLER Rectal Scissors

Catalog Number	Tip	Blade	Length (in.)
BC627R	B/B	CVD	12 3/4

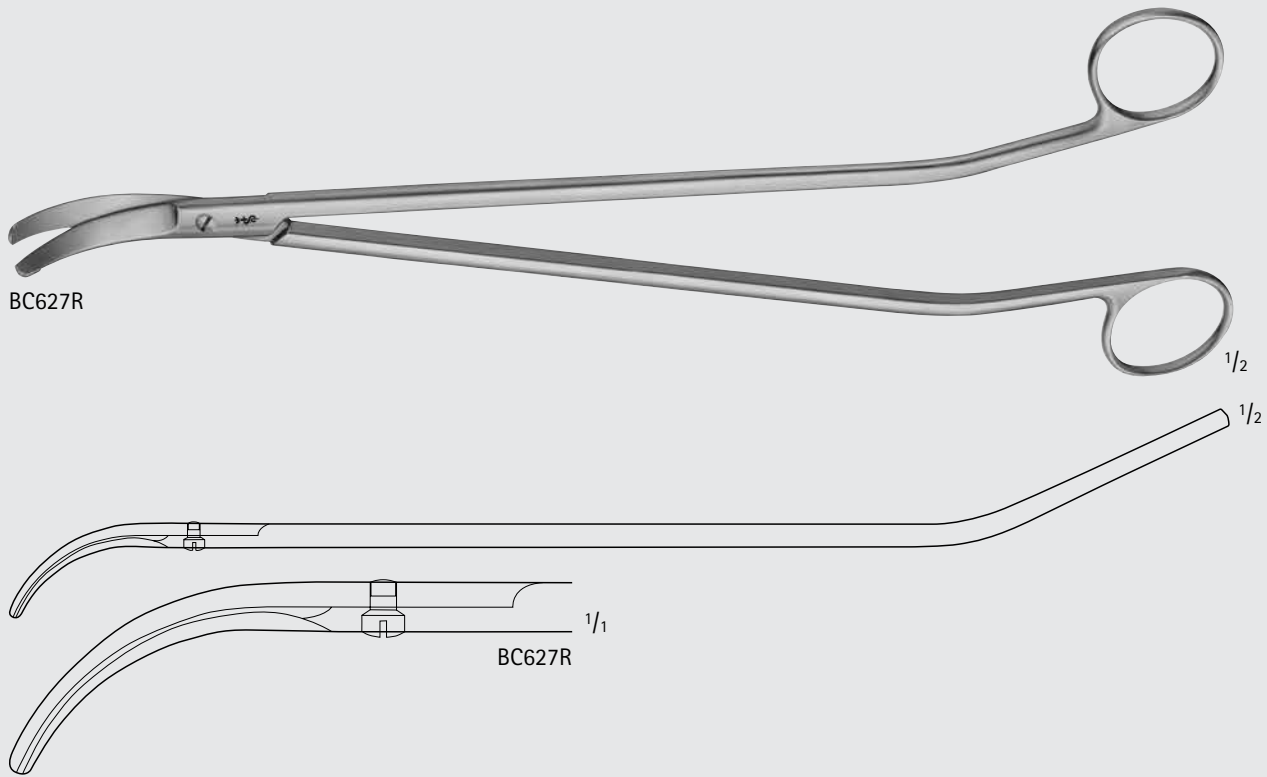

HARVEY Wire Scissors

Catalog Number	Tip	Blade	Length (in.)
BC815R	B/B	SERR	5

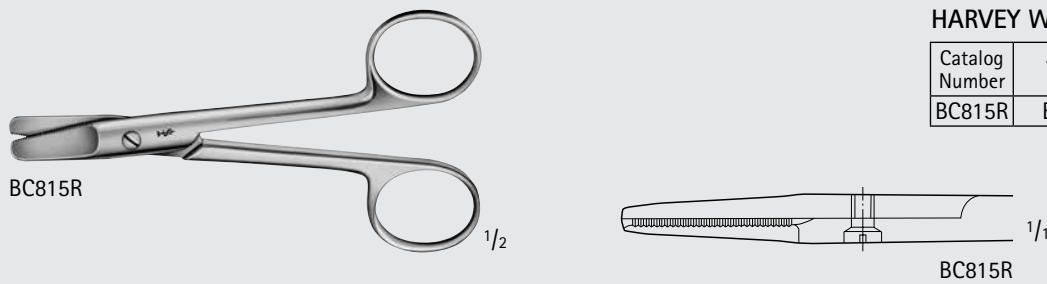

Wire Cutting Scissors

Catalog Number	For Wire Size	Length (in.)
DP551R	SOFT, UP TO 1.2MM AND HARD, UP TO 0.6 MM	4 3/4

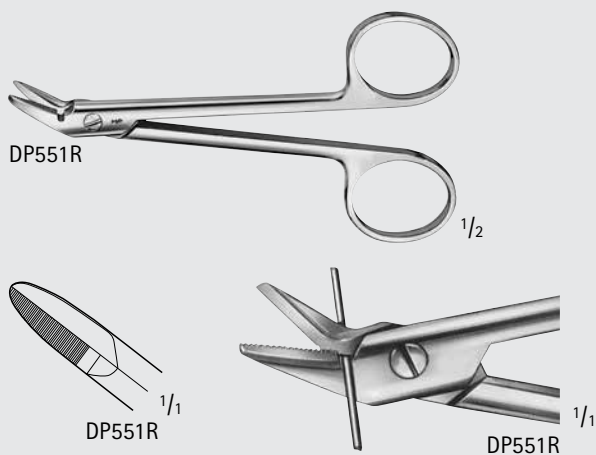

# General Surgery

## Delicate Scissors

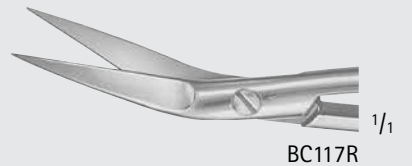
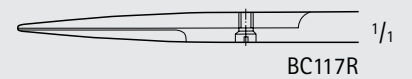
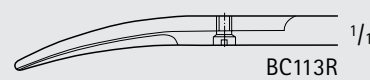
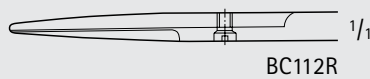
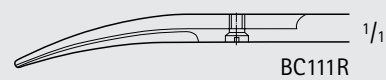
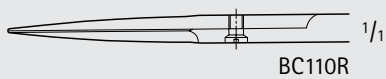
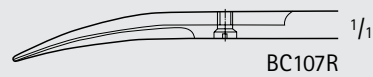
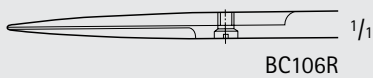
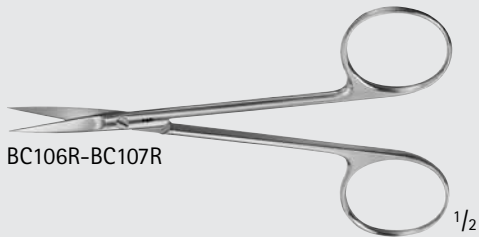
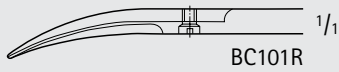
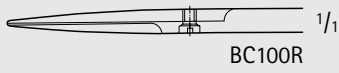
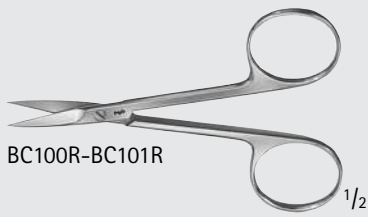
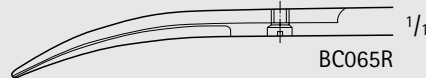
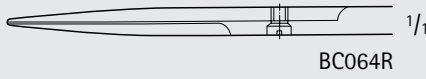

### Iris Scissors

Catalog Number	Tip	Blade	Length (in.)
BC100R	S/S	STR	3 1/2
BC110R	S/S	STR	4 1/4
BC106R	S/S	STR	4 1/2
BC064R	S/S	STR	4 3/4
BC101R	S/S	CVD	3 1/2
BC111R	S/S	CVD	4 1/4
BC107R	S/S	CVD	4 1/2
BC065R	S/S	CVD	4 3/4
BC112R	S/B	STR	4 1/4
BC113R	S/B	CVD	4 1/4
BC117R	S/S	LAT-ANG	4 1/4

REYNOLDS-JAMESON Tenotomy Scissors

Catalog Number	Tip	Blade	Handle	Length (in.)
BC015R	B/B	CVD	SQUARE	5 1/2

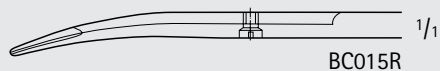
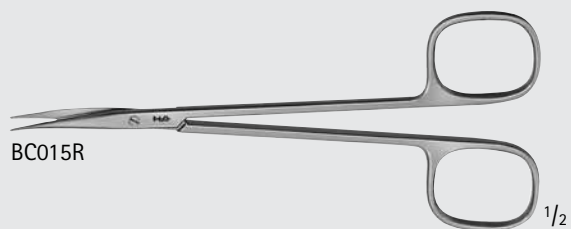

Strabismus Scissors

Catalog Number	Tip	Blade	Length (in.)
BC164R	B/B	STR	4 1/2
BC165R	B/B	CVD	4 1/2

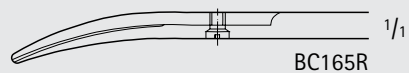
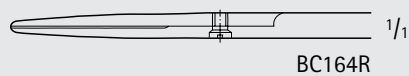

# General Surgery

## Delicate Scissors

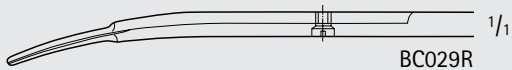
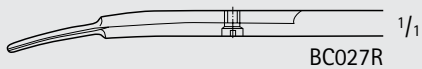
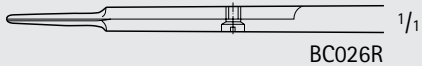
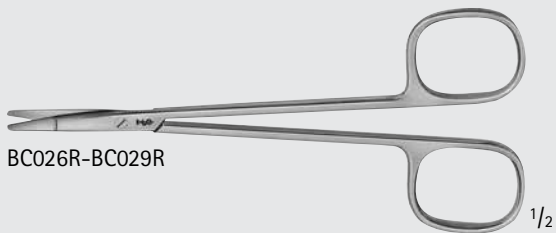

### RAGNELL Dissecting Scissors

Catalog Number	Tip	Blade	Length (in.)
BC026R	B/B	STR	5 1/4
BC027R	B/B	CVD	5 1/4
BC029R	B/B	CVD	6

CHADWICK Scissors, Delicate

Catalog Number	Tip	Blade	Length (in.)
BC153R	S/S	CVD	4 1/2

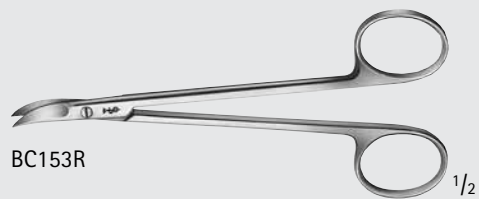

BC153R

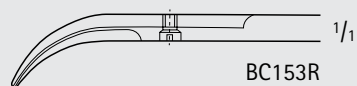

BC153R

LA GRANGE Scissors

Catalog Number	Tip	Blade	Length (in.)
BC154R	S/S	1-SERR	4 1/4

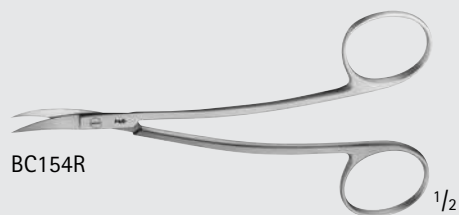

BC154R

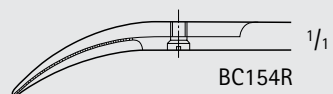

BC154R

KELLY Scissors

Catalog Number	Tip	Blade	Length (in.)
BC160R	S/S	STR	6 7/8
BC161R	S/S	CVD	6 7/8

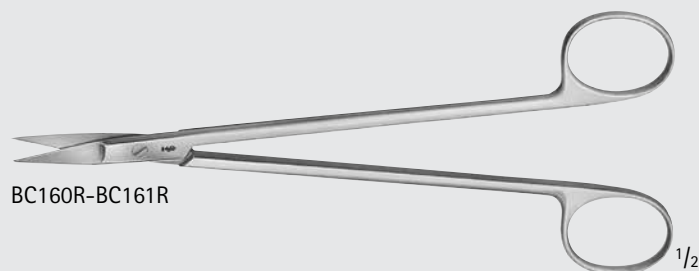

BC160R-BC161R

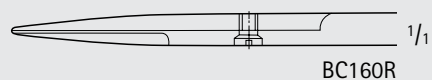

BC160R

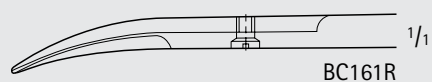

BC161R

# General Surgery

## Delicate Scissors

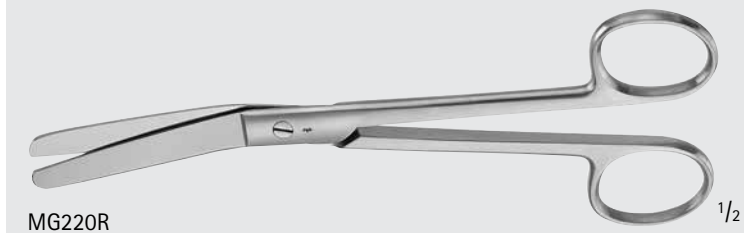

MG220R

1/2

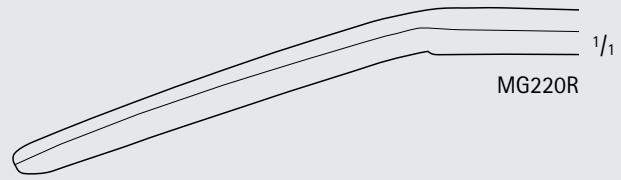

MG220R

1/1

### ROCHESTER-FERGUSON Scissors

Catalog Number	Tip	Blade	Length (in.)
MG220R	B/B	ANG FLAT	7

DUROTIP Tungsten Carbide Scissors

- Excellent cutting accuracy
- Long working life
- Gold-plated rings

DUROTIP TC Suture Scissors

Catalog Number	Tip	Blade	Length (in.)
BC228R	S/S	STR	5 3/4
BC224R	S/B	STR	5 3/4
BC234R	S/B	CVD	5 3/4

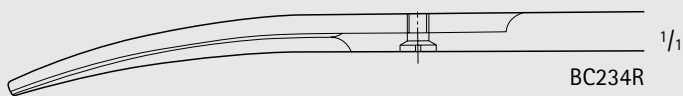
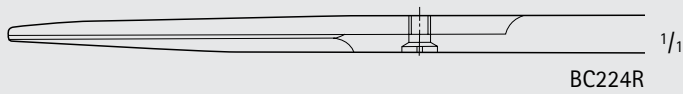
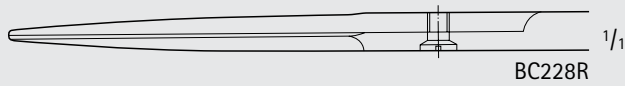

DUROTIP TC Operating Scissors

Catalog Number	Tip	Blade	Length (in.)
BC236R	S/S	STR	5 3/4
MB171R	S/S	CVD	5 3/4

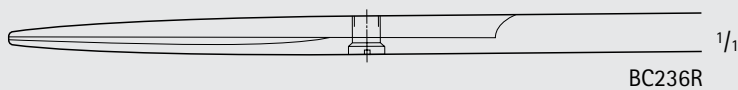
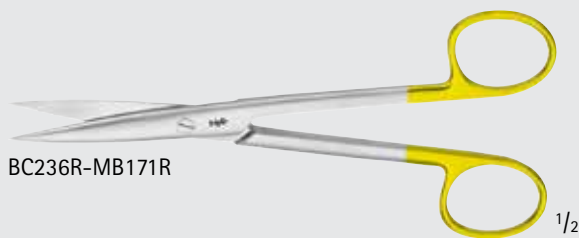

INCHES

General Surgery  
DUROTIP™ TC Scissors

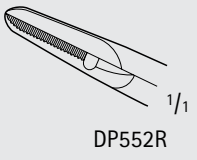
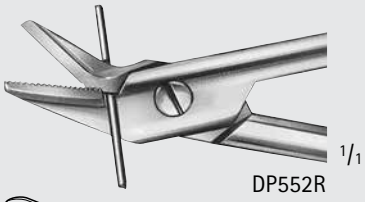
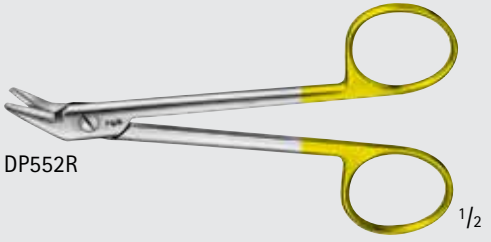

DUROTIP TC Wire Cutting Scissors

Catalog Number	Blade	For Wire Size	Length (in.)
DP552R	1-SERR	SOFT, UP TO 1.2 MM AND HARD, UP TO 0.8 MM	4 3/4

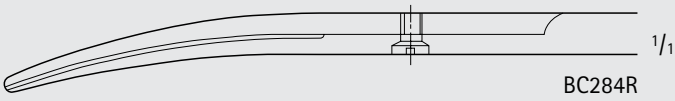
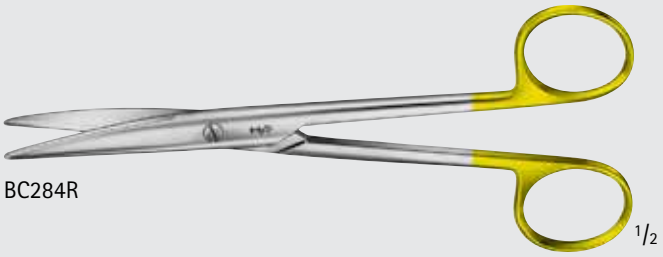

DUROTIP TC MAYO-LEXER Dissecting Scissors, Round Blades

Catalog Number	Tip	Blade	Length (in.)
BC284R	B/B	CVD	6 1/2

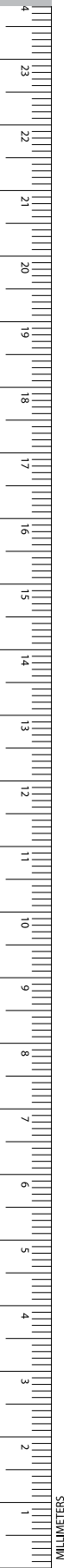

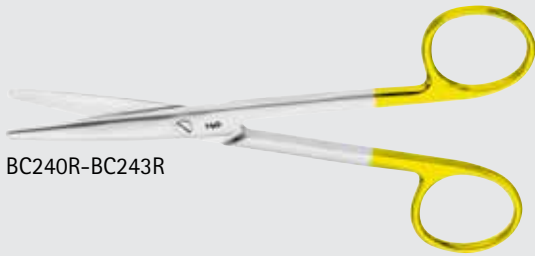

BC240R-BC243R

**DUROTIP TC MAYO Dissecting Scissors,  
Round Blades**

Catalog Number	Tip	Blade	Length (in.)
BC240R	B/B	STR	5 1/2
BC242R	B/B	STR	6 3/4
BC241R	B/B	CVD	5 1/2
BC243R	B/B	CVD	6 3/4

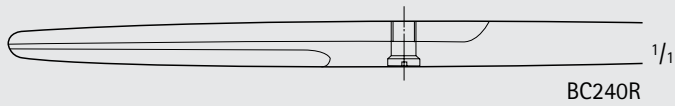

BC240R

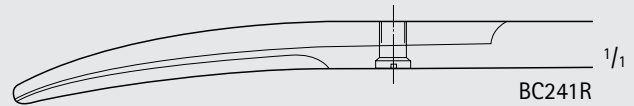

BC241R

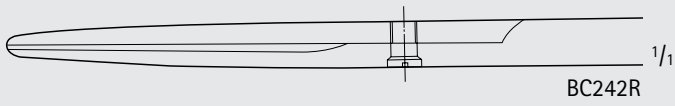

BC242R



BC243R



BC250R-BC253R

**DUROTIP TC MAYO Dissecting Scissors,  
Beveled Blades**

Catalog Number	Tip	Blade	Length (in.)
BC250R	B/B	STR	5 1/2
BC252R	B/B	STR	6 3/4
BC251R	B/B	CVD	5 1/2
BC253R	B/B	CVD	6 3/4

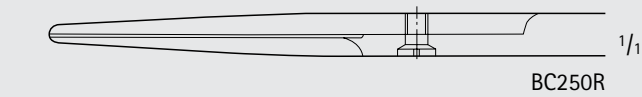

BC250R

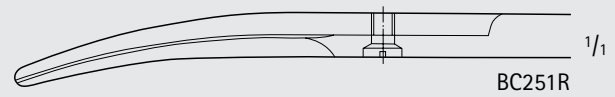

BC251R

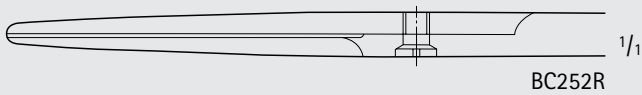

BC252R

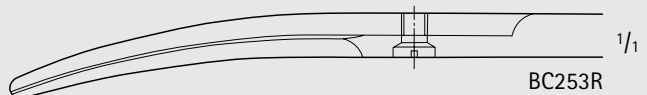

BC253R



INCHES

General Surgery  
DUROTIP™ TC Scissors

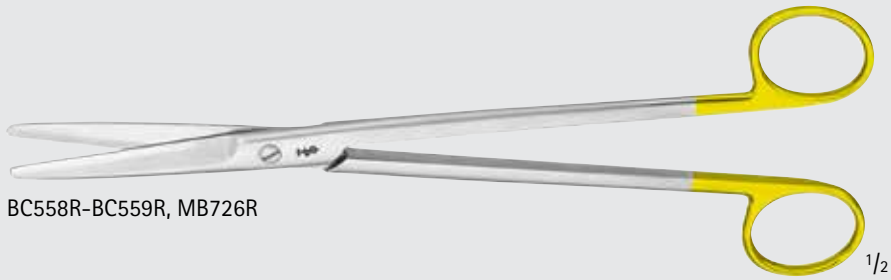

BC558R-BC559R, MB726R

DUROTIP TC MAYO Dissecting Scissors

Catalog Number	Tip	Blade	Length (in.)
BC558R	B/B	STR	9
MG215R	B/B	STR	14
BC559R	B/B	CVD	9
MB726R	B/B	CVD	14

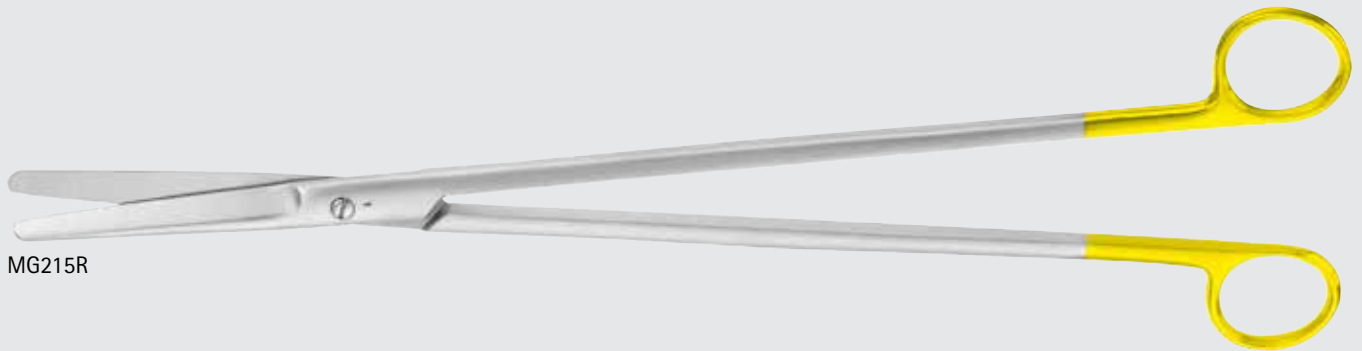
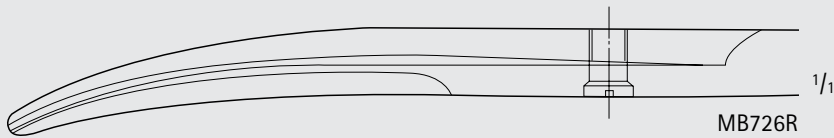
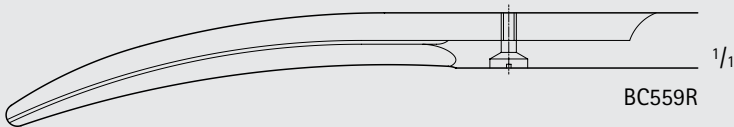
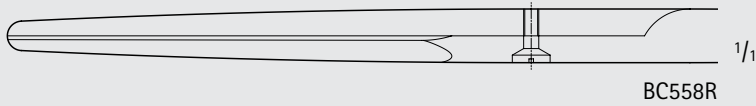

MG215R

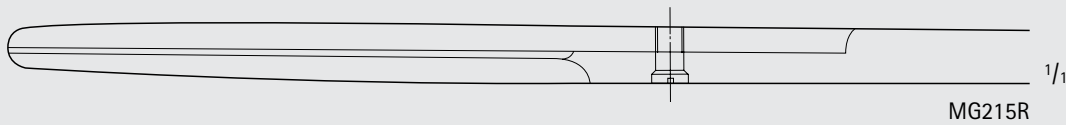

**DUROTIP TC METZENBAUM Dissecting Scissors, Delicate**

Catalog Number	Tip	Blade	Length (in.)
MB205R	S/S	STR	9 1/4
MB207R	S/S	CVD	5 3/4
MD496	S/S	CVD	7
MB206R	S/S	CVD	9 1/4

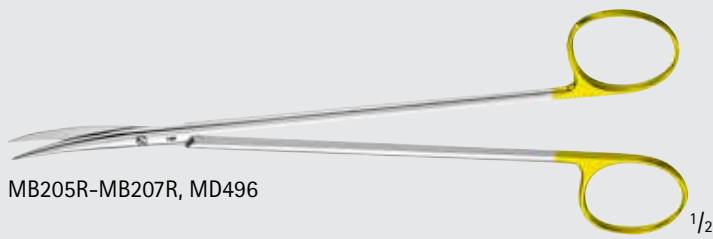

MB205R-MB207R, MD496



MB205R

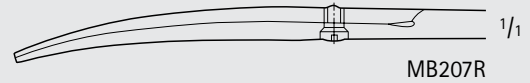

MB207R



MD496

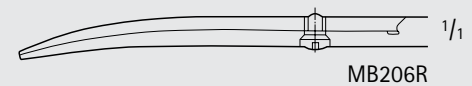

MB206R

**DUROTIP TC METZENBAUM Dissecting Scissors**

Catalog Number	Tip	Blade	Length (in.)
BC260R	B/B	STR	5 3/4
BC262R	B/B	STR	7
BC261R	B/B	CVD	5 3/4
BC263R	B/B	CVD	7
BC265R	B/B	CVD	7 7/8



BC260R-BC265R

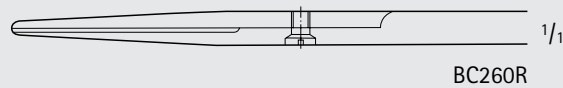

BC260R

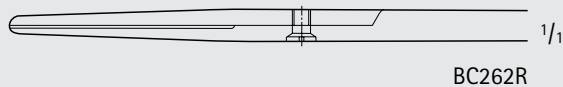

BC262R

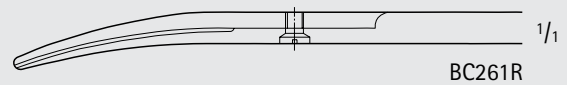

BC261R

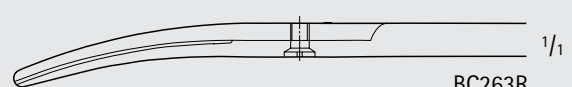

BC263R

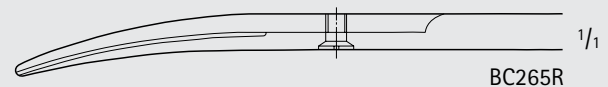

BC265R



# General Surgery

## DUROTIP™ TC Scissors

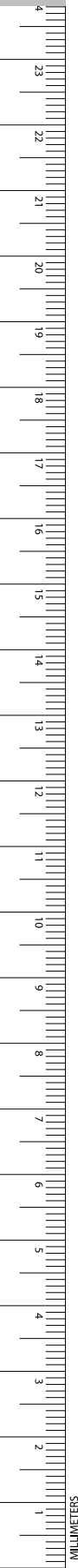

**BC287R**

**DUROTIP TC METZENBAUM Dissecting Scissors**

Catalog Number	Tip	Blade	Length (in.)
BC287R	B/B	CVD	9

**BC287R**

**BC270R-BC277R**

**DUROTIP TC METZENBAUM Dissecting Scissors, Delicate**

Catalog Number	Tip	Blade	Length (in.)
BC270R	B/B	STR	7
BC274R	B/B	STR	7 7/8
BC276R	B/B	STR	9
BC271R	B/B	CVD	7
BC275R	B/B	CVD	7 7/8
BC277R	B/B	CVD	9

**BC270R**

**BC271R**

**BC274R**

**BC275R**

**BC276R**

**BC277R**



BC258R-BC259R

**DUROTIP TC Baby METZENBAUM  
Dissecting Scissors, Delicate**

Catalog Number	Tip	Blade	Length (in.)
BC258R	B/B	STR	5 3/4
BC259R	B/B	CVD	5 3/4

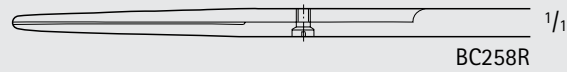

BC258R

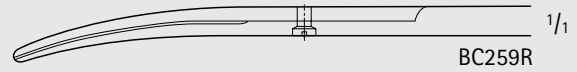

BC259R

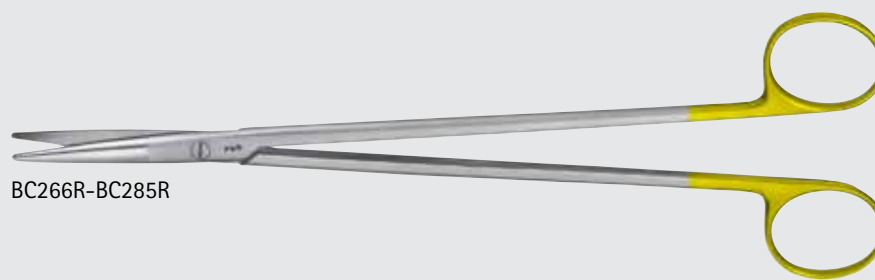

BC266R-BC285R

**DUROTIP TC NELSON-METZENBAUM  
Dissecting Scissors**

Catalog Number	Tip	Blade	Length (in.)
BC266R	B/B	STR	9
BC267R	B/B	CVD	9
BC279R	B/B	CVD	10 1/4
BC281R	B/B	CVD	11
BC282R	B/B	CVD	11 1/4
BC289R	B/B	CVD	11 3/4
BC285R	B/B	CVD	13 3/4

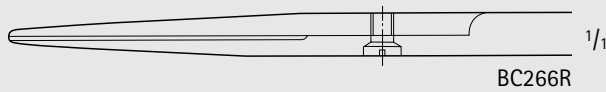

BC266R

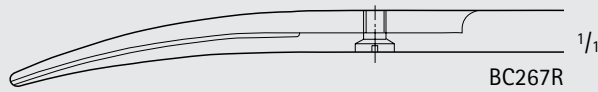

BC267R

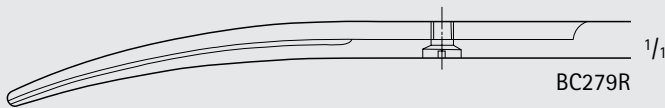

BC279R

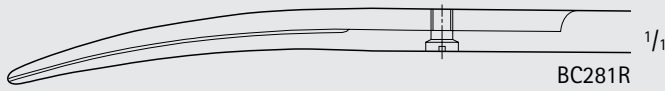

BC281R

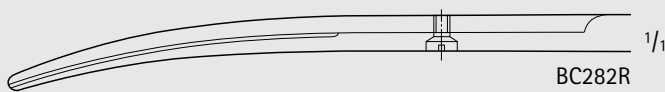

BC282R

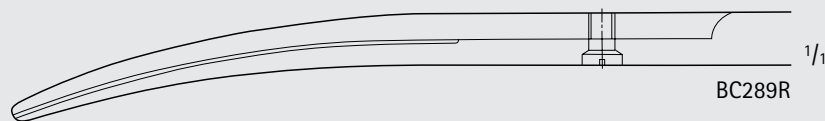

BC289R

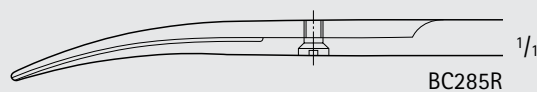

BC285R



INCHES

General Surgery  
DUROTIP™ TC Scissors

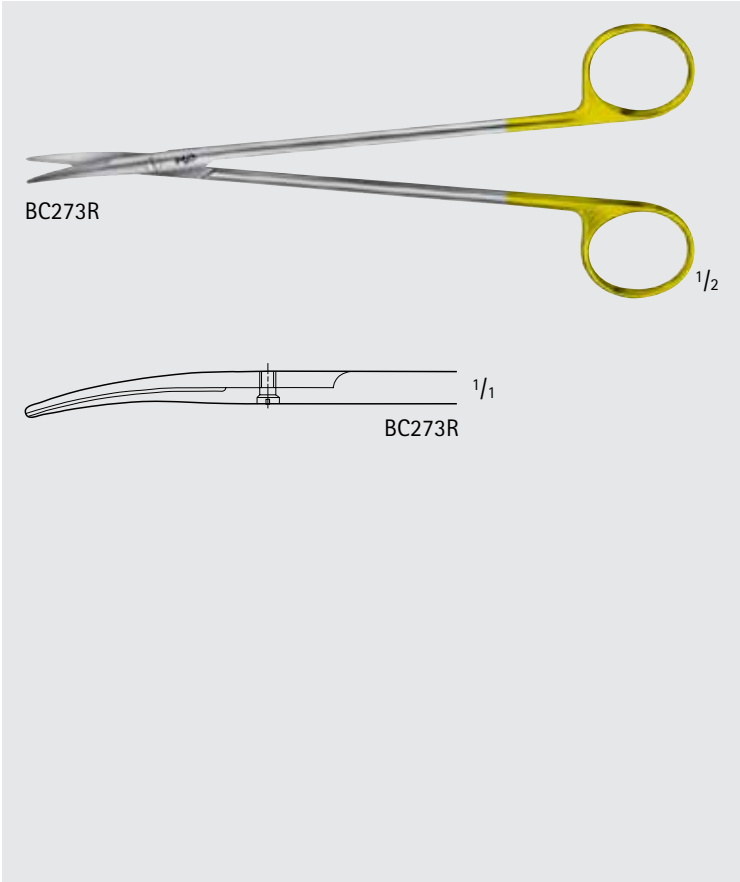
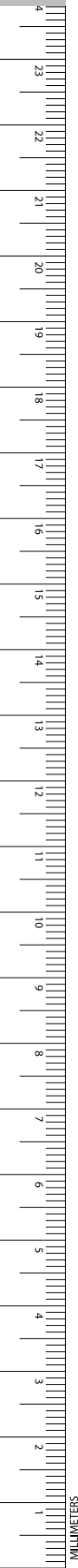

**DUROTIP TC TOENNIS-ADSON**  
Dissecting Scissors, Delicate

Catalog Number	Tip	Blade	Length (in.)
BC273R	B/B	CVD	6 7/8

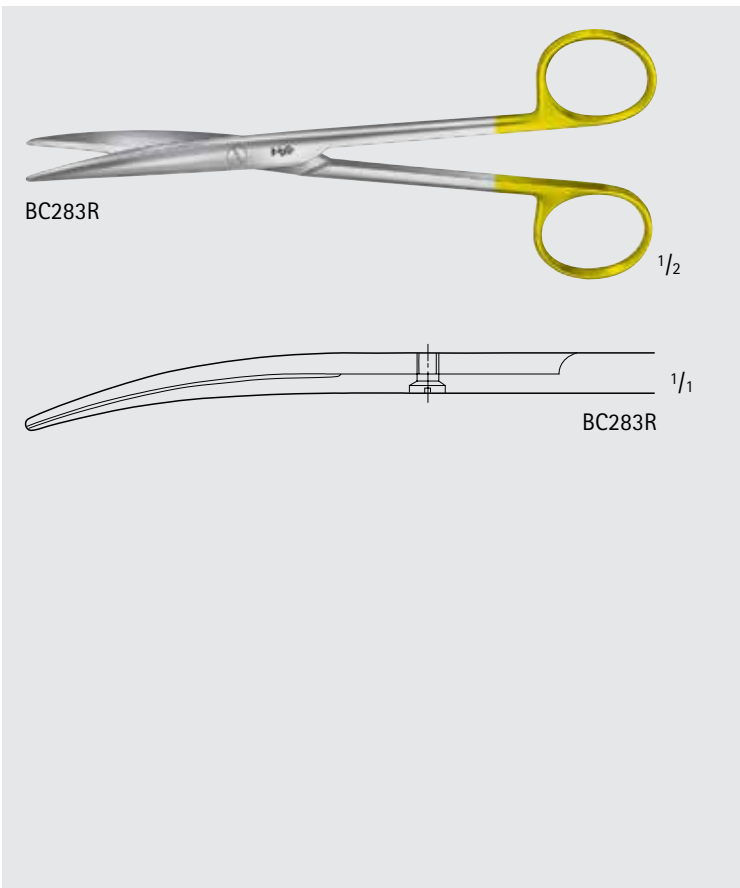

**DUROTIP TC LEXER** Dissecting Scissors,  
Delicate

Catalog Number	Tip	Blade	Length (in.)
BC283R	B/B	CVD	6 1/2



**Wavecut**

■ Wavecut scissors have one serrated cutting edge to prevent tissue from slipping. The W after the item number indicates the scissors are the wavecut style, e.g. BC211W.



BC253W

1/2

**DUROTIP TC MAYO Wavecut Dissecting Scissors, Beveled Blades**

Catalog Number	Tip	Blade	Length (in.)
BC253W	B/B	CVD	6 3/4

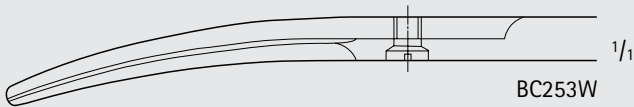

1/1

BC253W



BC259W

1/2

**DUROTIP TC Baby METZENBAUM Wavecut Dissecting Scissors, Delicate**

Catalog Number	Tip	Blade	Length (in.)
BC259W	B/B	CVD	5 3/4

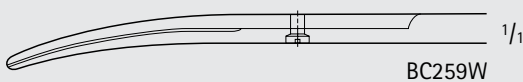

1/1

BC259W



# General Surgery

## DUROTIP™ TC Scissors



BC261W-BC265W

Catalog Number	Tip	Blade	Length (in.)
BC261W	B/B	CVD	5 3/4
BC263W	B/B	CVD	7
BC265W	B/B	CVD	7 7/8

BC261W 1/1

BC263W 1/1

BC265W 1/1

BC271W-BC277W

Catalog Number	Tip	Blade	Length (in.)
BC271W	B/B	CVD	7
BC275W	B/B	CVD	7 7/8
BC277W	B/B	CVD	9

BC271W 1/1

BC275W 1/1

BC277W 1/1

BC287W

Catalog Number	Tip	Blade	Length (in.)
BC287W	B/B	CVD	9

BC287W 1/1

**DUROTIP TC TOENNIS-ADSON Wavecut  
 Dissecting Scissors**

Catalog Number	Tip	Blade	Length (in.)
BC273W	B/B	CVD	6 7/8

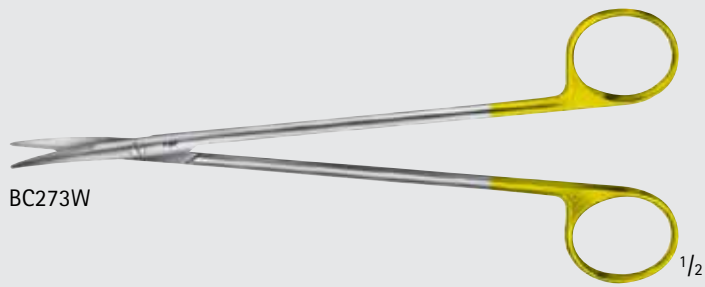

BC273W

1/2

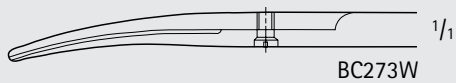

BC273W

1/16

**DUROTIP TC NELSON-METZENBAUM  
 Wavecut Dissecting Scissors**

Catalog Number	Tip	Blade	Length (in.)
BC267W	B/B	CVD	9
BC279W	B/B	CVD	10 1/4
BC281W	B/B	CVD	11

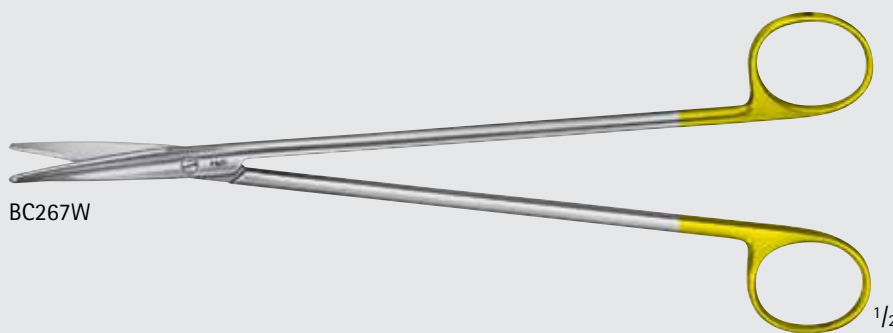

BC267W

1/2

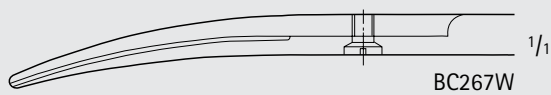

BC267W

1/16

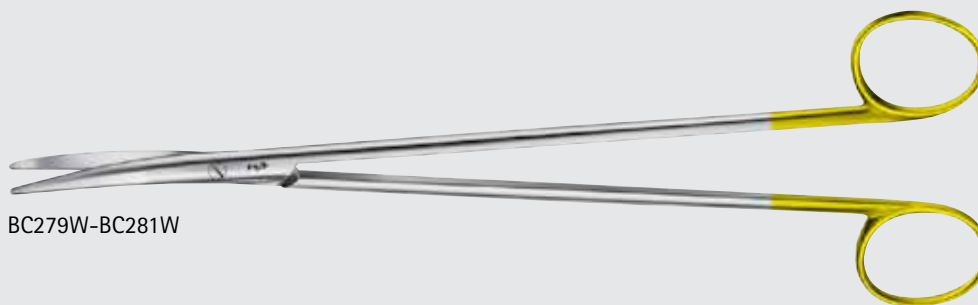

BC279W-BC281W

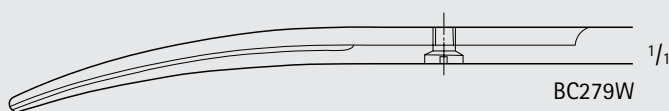

BC279W

1/16

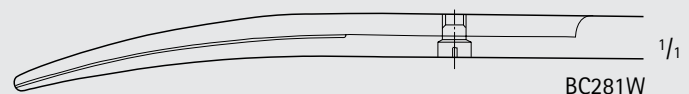

BC281W

1/16



INCHES

General Surgery  
DUROTIP™ TC Scissors

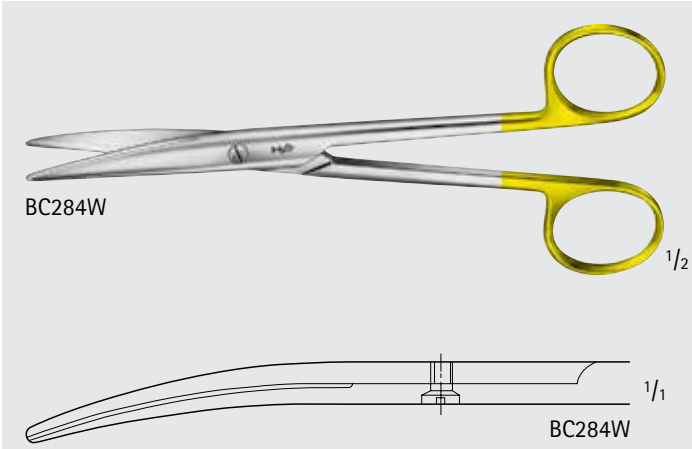
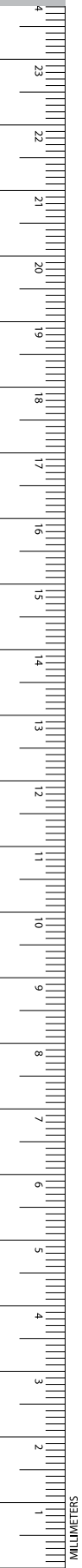

DUROTIP TC MAYO-LEXER Wavecut Scissors

Catalog Number	Tip	Blade	Length (in.)
BC284W	B/B	CVD	6 1/2

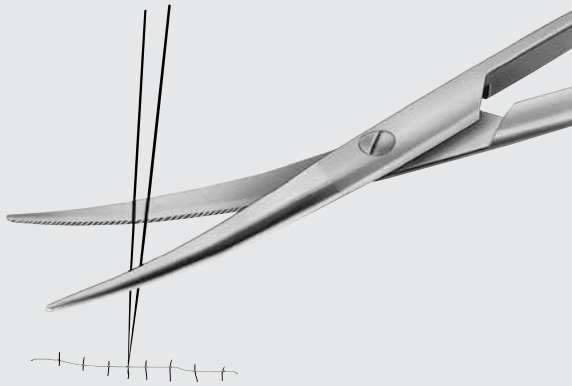

**DUROTIP TC Ligature Scissors**

- Carbide inserts guarantee permanent sharp cutting edge (also in the distal area of the blades).
- Wavecut prevents suture materials from slipping.
- Identified by 1 gold-plated ring.



BC294W-BC298W

**DUROTIP TC Ligature Wavecut Scissors**

Catalog Number	Tip	Blade	Length (in.)
BC294W	B/B	CVD	5 3/4
BC295W	B/B	CVD	7
BC296W	B/B	CVD	9
BC297W	B/B	CVD	10 1/4
BC298W	B/B	CVD	13 3/4

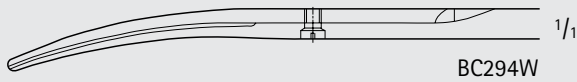

BC294W

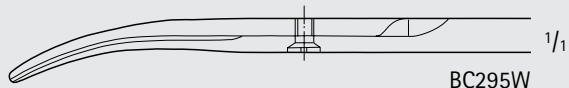

BC295W

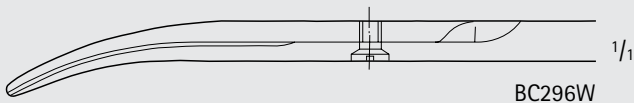

BC296W

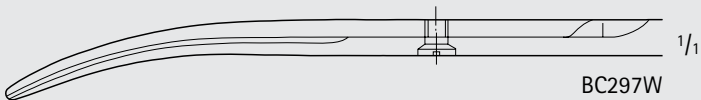

BC297W

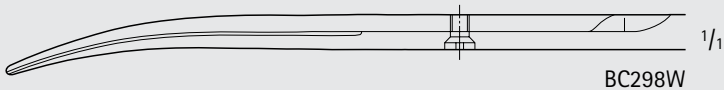

BC298W



# General Surgery

## SuperCut Scissors

### SuperCut Scissors

Your everyday black handle scissors

- **Microtome Edge**
  - Razor sharp cutting edge facilitates gentle cutting with minimal force
- **Wavecut Blade**
  - Prevents tissue from slipping out during the cutting process

For more information about SuperCut Scissors see brochure number **DOC821**.



BC900R-BC901R

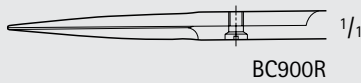

BC900R

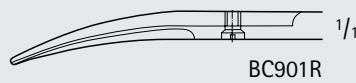

BC901R

### Iris SuperCut Scissors, Delicate

Catalog Number	Tip	Blade	Length (in.)
BC900R	S/S	STR	4 1/4
BC901R	S/S	CVD	4 1/4



BC903R

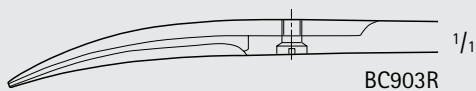

BC903R

### SuperCut Plastic Standard Scissors

Catalog Number	Tip	Blade	Length (in.)
BC903R	S/S	CVD	5



BC904R-BC905R

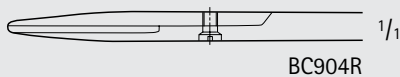

BC904R

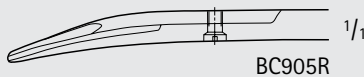

BC905R

### STEVENS SuperCut Scissors

Catalog Number	Tip	Tip Size (mm)	Blade	Length (in.)
BC904R	B/B	12	STR	4 1/8
BC905R	B/B	12	CVD	4 1/8

STEVENS SuperCut Scissors (continued)

Catalog Number	Tip	Tip Size (mm)	Blade	Length (in.)
BC906R	B/B	13	STR	4 1/4
BC907R	B/B	13	CVD	4 1/4

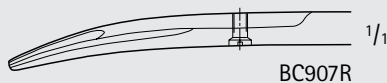
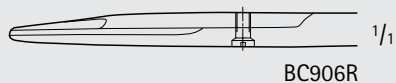
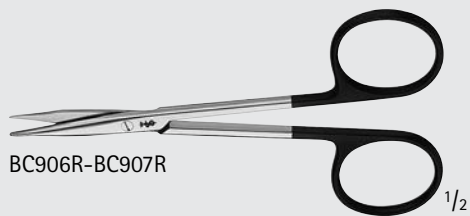

GOLDMANN-FOX SuperCut Scissors

Catalog Number	Tip	Blade	Length (in.)
BC909R	S/S	CVD	5 1/8

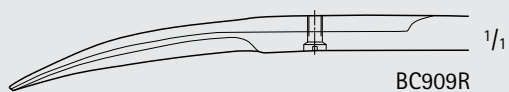

# General Surgery

## SuperCut Scissors

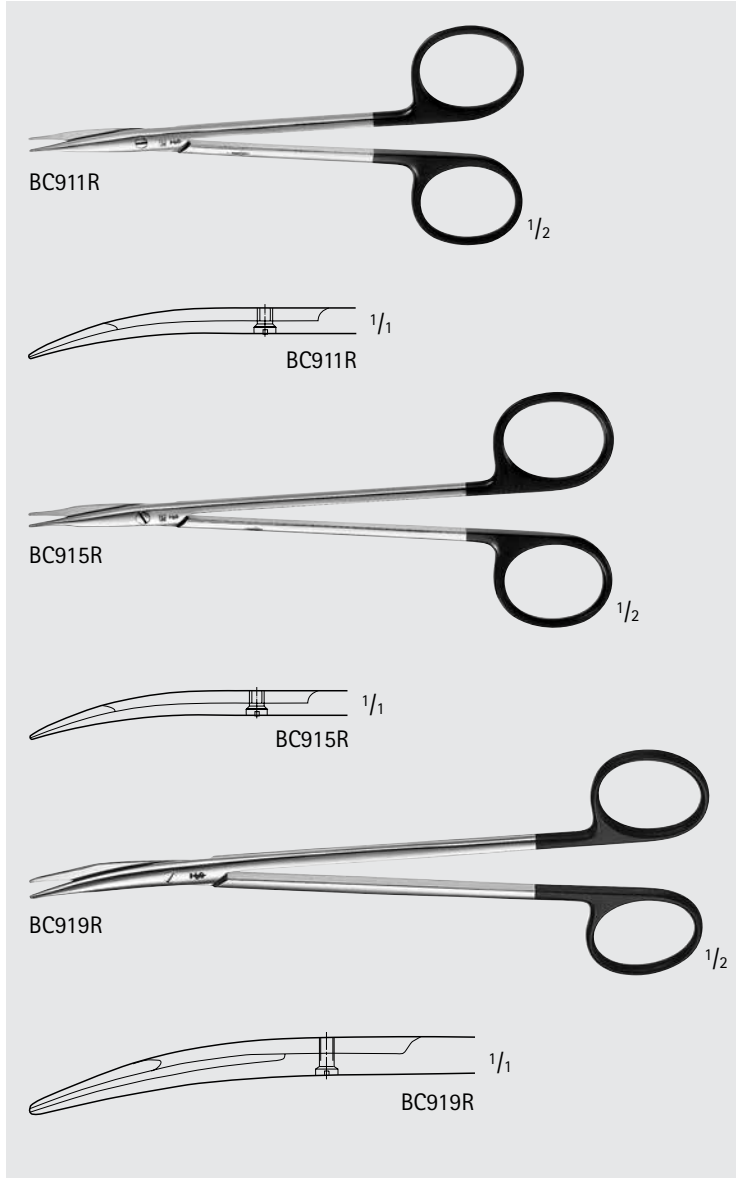

### JAMESON SuperCut Scissors, Delicate

Catalog Number	Tip	Blade	Length (in.)
BC911R	B/B	CVD	5 1/8
BC915R	B/B	CVD	6
BC919R	B/B	CVD	7

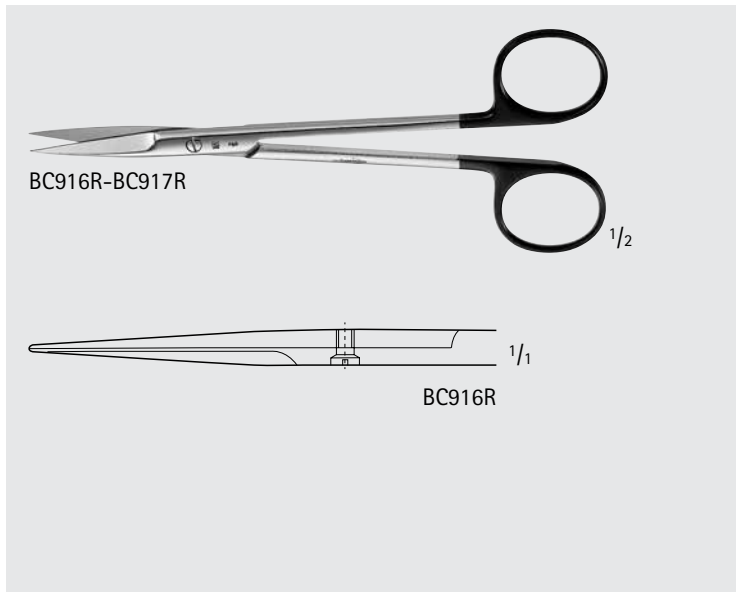

### JOSEPH SuperCut Scissors, Delicate

Catalog Number	Tip	Blade	Length (in.)
BC916R	S/S	STR	6
BC917R	S/S	CVD	6



**GORNEY SuperCut Scissors, Delicate**

Catalog Number	Tip	Blade	Length (in.)
BC920R	B/B	STR	7 3/4
BC921R	B/B	CVD	7 3/4



BC920R-BC921R

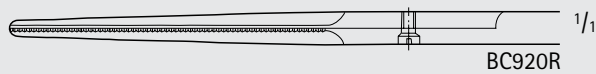

BC920R

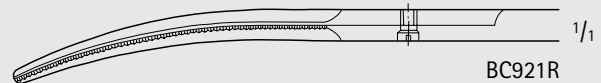

BC921R

**KAYE SuperCut Facelift Scissors, Delicate**

Catalog Number	Tip	Blade	Length (in.)
BC933R	B/B	CVD	7 3/4

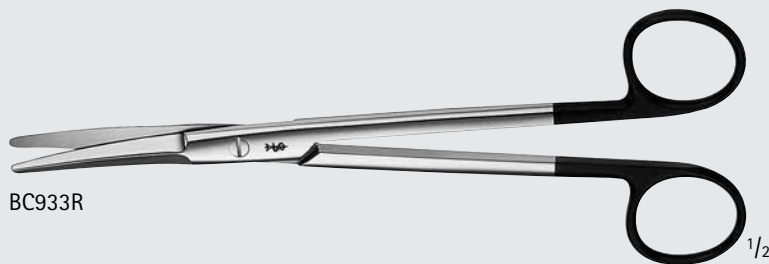

BC933R

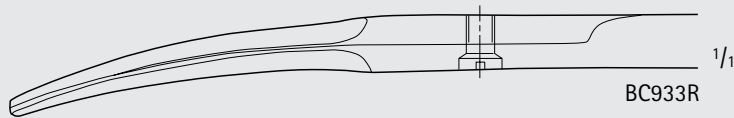

BC933R

**MAYO SuperCut Scissors, Delicate**

Catalog Number	Tip	Blade	Length (in.)
BC926R	B/B	STR, BEVELED	5 3/4
BC927R	B/B	CVD, BEVELED	5 3/4
BC924R	B/B	STR, ROUND	6 1/2
BC925R	B/B	CVD, ROUND	6 1/2



BC926R-BC927R

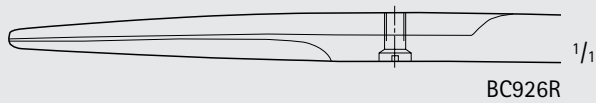

BC926R

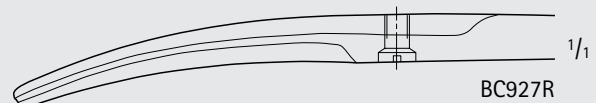

BC927R



BC924R-BC925R

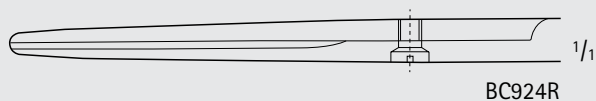

BC924R

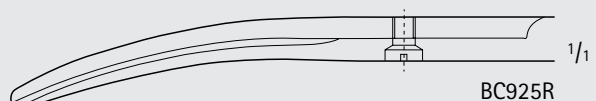

BC925R

# General Surgery

## SuperCut Scissors

MAYO SuperCut Scissors, Beveled

Catalog Number	Tip	Blade	Length (in.)
MG216R	B/B	STR	9
BC922R	B/B	STR	10
BC938R	B/B	STR	12
MG087R	B/B	CVD	9
BC929R	B/B	CVD	11

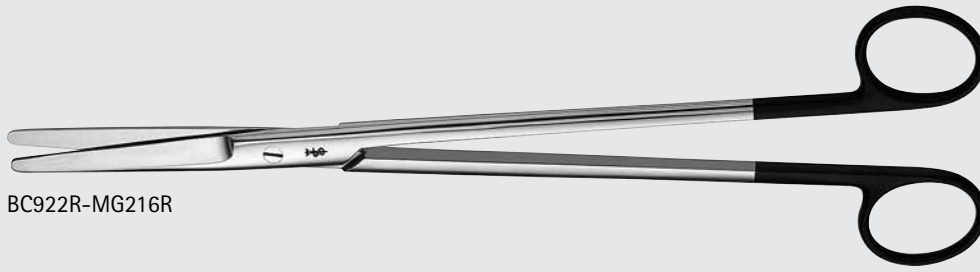

BC922R-MG216R

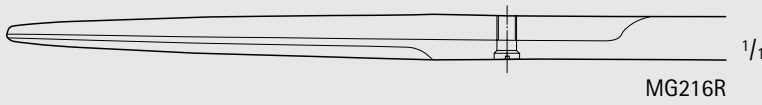

MG216R

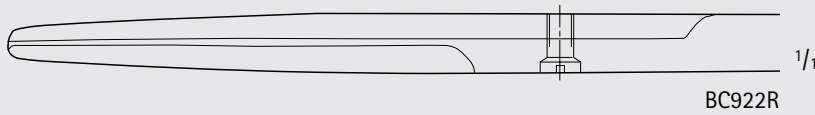

BC922R

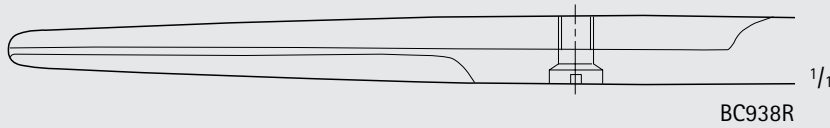

BC938R

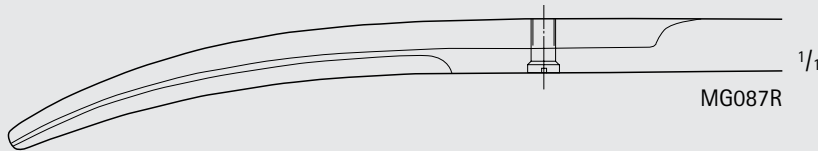

MG087R

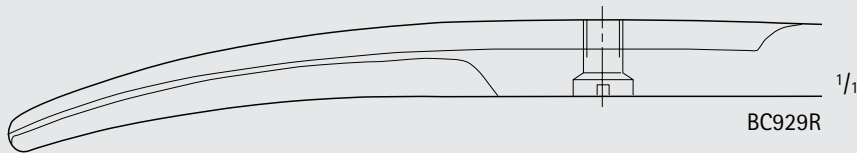

BC929R

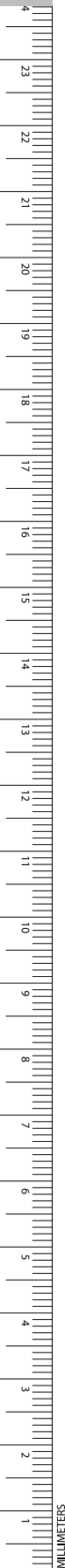

Baby METZENBAUM SuperCut  
Scissors, Delicate

Catalog Number	Tip	Blade	Length (in.)
BC930R	B/B	STR	4 1/2
BC931R	B/B	CVD	4 1/2



BC930R-BC931R

1/2

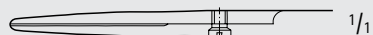

BC930R

1/1

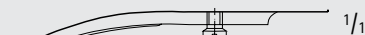

BC931R

1/1



BC934R-BC937R

METZENBAUM SuperCut Scissors,  
Delicate

Catalog Number	Tip	Blade	Length (in.)
BC934R	B/B	STR	5 3/4
BC936R	B/B	STR	7
BC935R	B/B	CVD	5 3/4
BC937R	B/B	CVD	7

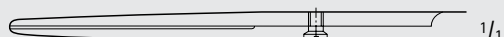

BC934R

1/1

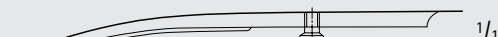

BC935R

1/1

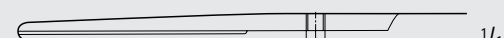

BC936R

1/1

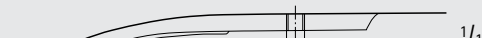

BC937R

1/1

# General Surgery

## SuperCut Scissors

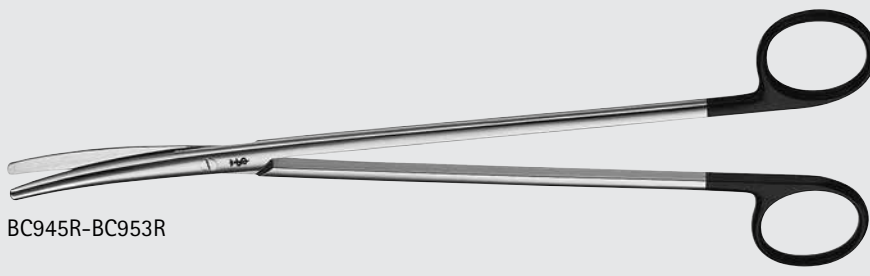
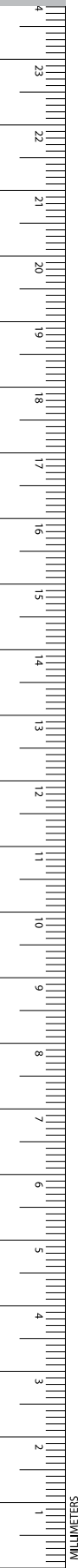

BC945R-BC953R

### METZENBAUM SuperCut Scissors, Delicate

Catalog Number	Tip	Blade	Length (in.)
BC945R	B/B	CVD	9
BC947R	B/B	CVD	10 1/4
BC949R	B/B	CVD	11 1/4
BC951R	B/B	CVD	11 3/4
BC953R	B/B	CVD	14

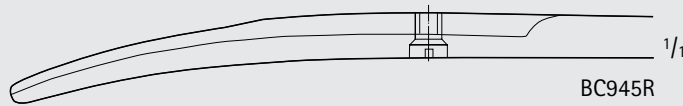

BC945R

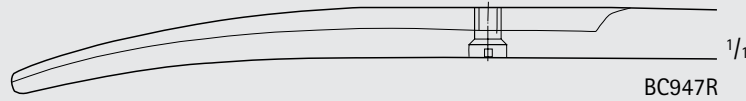

BC947R

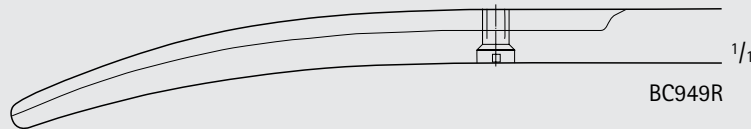

BC949R

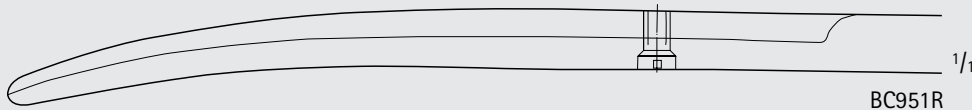

BC951R

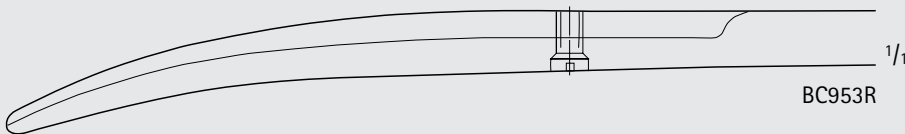

BC953R

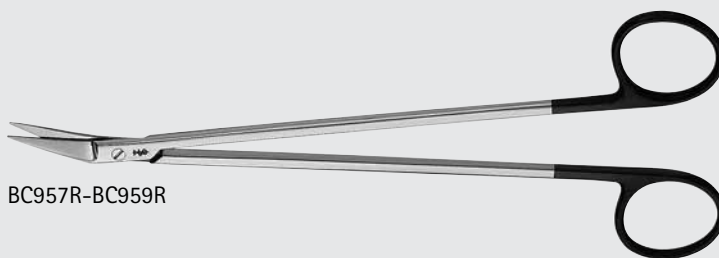

BC957R-BC959R

### POTTS-SMITH SuperCut Scissors

Catalog Number	Tip	Blade Angle	Blade Size (mm)	Length (in.)
BC957R	B/B	25°	22	7 1/2
BC958R	B/B	45°	20	7 1/4
BC959R	B/B	60°	19	7



BC957R



BC958R



BC959R

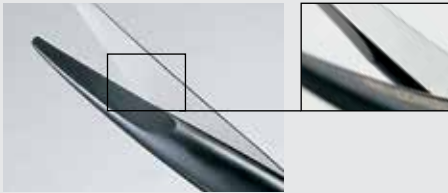

Microtome Edge

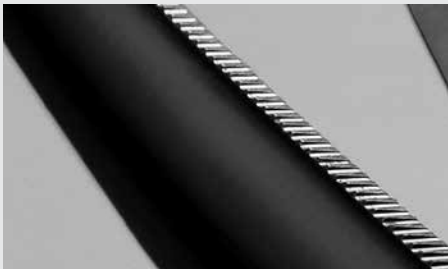

Wavecut

Noir Supreme Cut Scissors

- **Noir**  
The combination of the renowned Aesculap Tungsten Carbide technology with the Aesculap Noir coating results in an extremely high surface hardness and therefore high wear resistance in daily hospital use.
- **Microtome edge**  
The extremely sharp cutting edge of the scissors blade facilitates gentle cutting of tissue with minimal use of force.
- **Wavecut** prevents tissue from slipping out during the cutting process.
- The WB after the item number indicates the Noir scissors are the wavecut style, e.g. BC211WB.

For more information about Noir Supreme Cut Scissors see our brochure number DOC637.



BC252B-BC253WB

1/2



1/1

BC252B



1/1

BC253B, BC253WB

Noir MAYO Dissecting Scissors

Catalog Number	Tip	Blade	Length (in.)
BC252B	B/B	STR	6 3/4
BC253B	B/B	CVD	6 3/4
BC253WB	B/B	CVD	6 3/4



BC284B-BC284WB

1/2



1/1

BC284B-BC284WB

Noir MAYO-LEXER Dissecting Scissors

Catalog Number	Tip	Blade	Length (in.)
BC284B	B/B	CVD	6 1/2
BC284WB	B/B	CVD	6 1/2

# General Surgery

## Noir™ Supreme Cut Scissors



### Noir LEXER Dissecting Scissors

Catalog Number	Tip	Blade	Length (in.)
BC283B	B/B	DEL, CVD	6 1/2
BC283WB	B/B	DEL, CVD	6 1/2



### Noir Iris Dissecting Scissors

Catalog Number	Tip	Blade	Length (in.)
BC210B	S/S	STR	4 1/4
BC211B	S/S	CVD	4 1/4
BC211WB	S/S	CVD	4 1/4



### Noir TOENNIS-ADSON Dissecting Scissors

Catalog Number	Tip	Blade	Length (in.)
BC273B	B/B	DEL, CVD	6 7/8
BC273WB	B/B	DEL, CVD	6 7/8

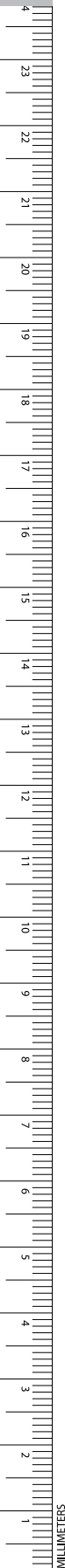

# General Surgery

## Noir™ Supreme Cut Scissors

### Noir METZENBAUM Dissecting Scissors

Catalog Number	Tip	Blade	Length (in.)
BC261B	B/B	CVD	5 3/4
BC261WB	B/B	CVD	5 3/4
BC263B	B/B	CVD	7
BC263WB	B/B	CVD	7
BC271B	B/B	DEL, CVD	7
BC271WB	B/B	DEL, CVD	7
BC265B	B/B	CVD	7 7/8
BC265WB	B/B	CVD	7 7/8
BC275B	B/B	DEL, CVD	7 7/8
BC275WB	B/B	DEL, CVD	7 7/8
BC267B	B/B	CVD	9
BC267WB	B/B	CVD	9
BC277B	B/B	DEL, CVD	9
BC277WB	B/B	DEL, CVD	9

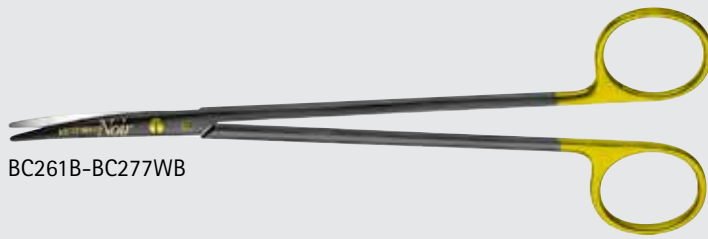

BC261B-BC277WB



BC261B, BC261WB

1/1



BC263B, BC263WB

1/1



BC271B, BC271WB

1/1



BC265B, BC265WB

1/1



BC275B, BC275WB

1/1



BC267B, BC267WB

1/1



BC277B, BC277WB

1/1



INCHES

# General Surgery

## Noir™ Supreme Cut Scissors

### Noir NELSON-METZENBAUM Dissecting Scissors

Catalog Number	Tip	Blade	Length (in.)
BC279B	B/B	DEL, CVD	10 1/4
BC279WB	B/B	DEL, CVD	10 1/4
BC281B	B/B	DEL, CVD	11
BC281WB	B/B	DEL, CVD	11

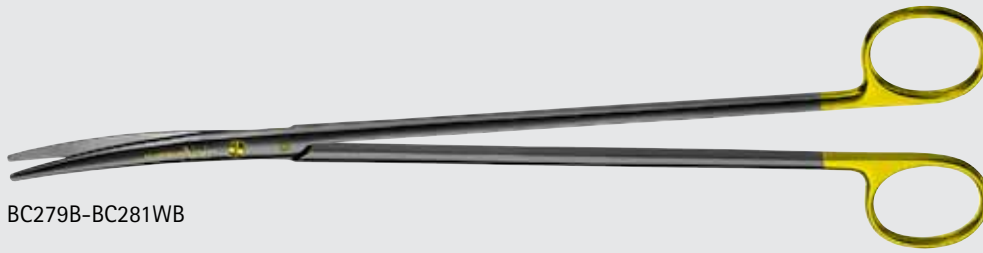

BC279B-BC281WB



BC279B, BC279WB



BC281B, BC281WB

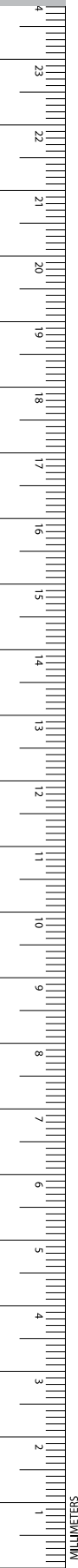

**CONVERSE Needle Holder**

Catalog Number	Jaw	Length (in.)
BM200R	LONG SERR	5 1/8

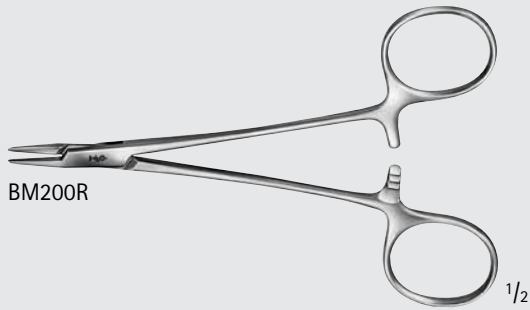

BM200R

BM200R 1/1

**HALSEY Needle Holder**

Catalog Number	Tip	Jaw	Length (in.)
BM201R	DEL	SMOOTH	5 1/8
BM205R	DEL	X-SERR	5 1/8

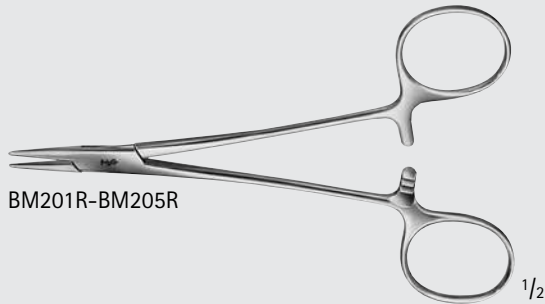

BM201R-BM205R

BM201R 1/1

BM205R 1/1

**WEBSTER Needle Holder**

Catalog Number	Jaw	Length (in.)
BM202R	SMOOTH	5

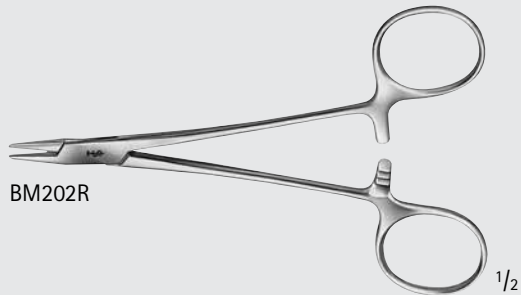

BM202R

BM202R 1/1

**DERF Needle Holder**

Catalog Number	Jaw	Length (in.)
BM204R	SERR	5

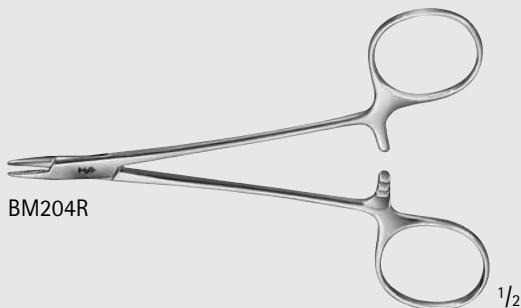

BM204R

BM204R 1/1



INCHES

# General Surgery

## Needle Holders



BM210R

1/2



BM210R

1/1

### DOYEN Needle Holder

Catalog Number	Jaw	Length (in.)
BM210R	X-SERR	5

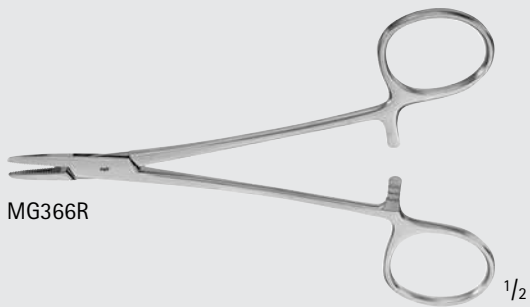

MG366R

1/2



MG366R

1/1

### COLLIER Needle Holder, Fenestrated

Catalog Number	Jaw	Length (in.)
MG366R	SERR	5

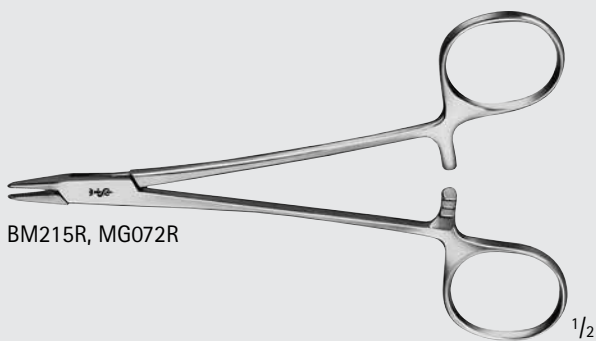

BM215R, MG072R

1/2



MG072R

1/1



BM215R

1/1

### BAUMGARTNER Needle Holder

Catalog Number	Jaw	Length (in.)
MG072R	SERR, GROOVED	5 1/4
BM215R	X-SERR	5 3/4



**CRILE-WOOD Needle Holder**

Catalog Number	Jaw	Length (in.)
BM218R	X-SERR	6
BM220R	X-SERR	6 1/4

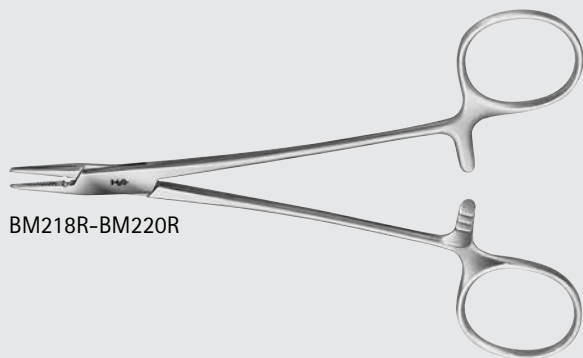

BM218R-BM220R

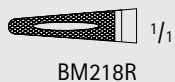

BM218R



BM220R

**CRILE-MURRAY Needle Holder**

Catalog Number	Jaw	Length (in.)
BM219R	SERR	6

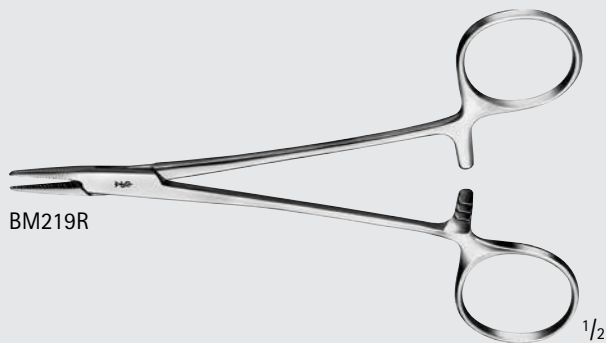

BM219R



BM219R

**ADSON Needle Holder, Fenestrated**

Catalog Number	Jaw	Length (in.)
BM224R	SERR	7

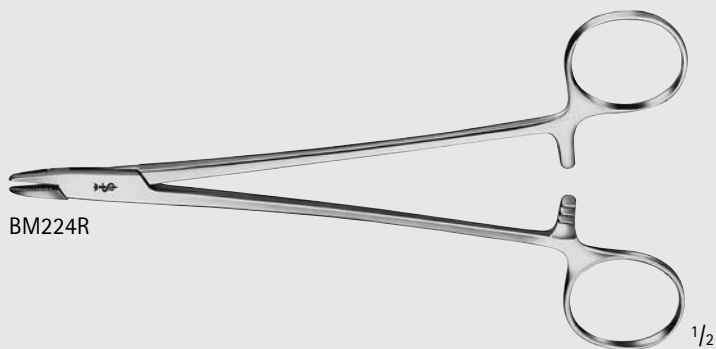

BM224R



BM224R



1/1

# General Surgery

## Needle Holders

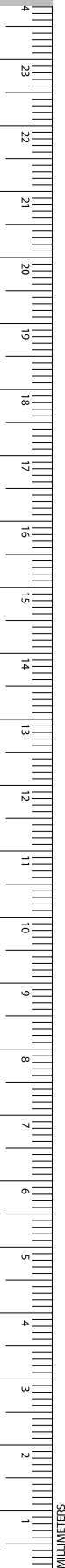
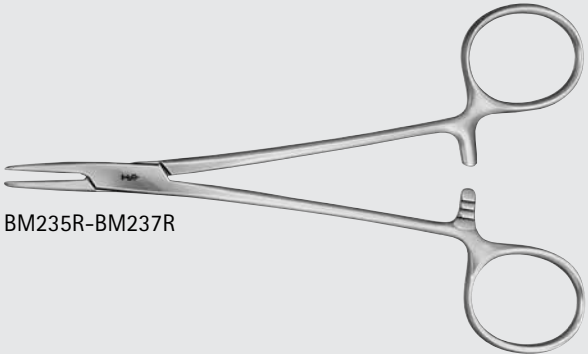
BM235R-BM237R



BM235R 1/1



BM236R 1/1



BM237R 1/1

### MAYO-HEGAR Needle Holder

Catalog Number	Jaw	Length (in.)
BM235R	X-SERR	6
BM236R	X-SERR	7 1/4
BM237R	X-SERR	7 7/8

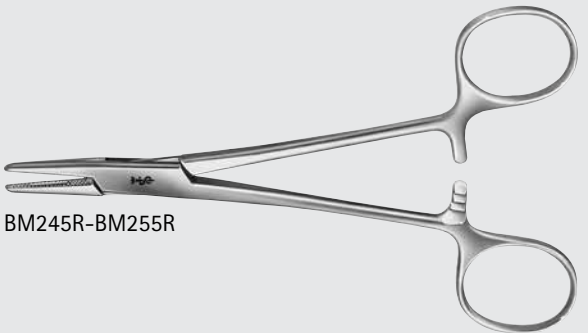

BM245R-BM255R



BM245R 1/1



BM247R 1/1



BM249R 1/1



BM255R 1/1

### HEGAR Needle Holder

Catalog Number	Tip	Jaw	Length (in.)
BM245R	HEAVY	X-SERR	6
BM247R	HEAVY	X-SERR	6 7/8
BM249R	HEAVY	X-SERR	8
BM255R	HEAVY	X-SERR	8

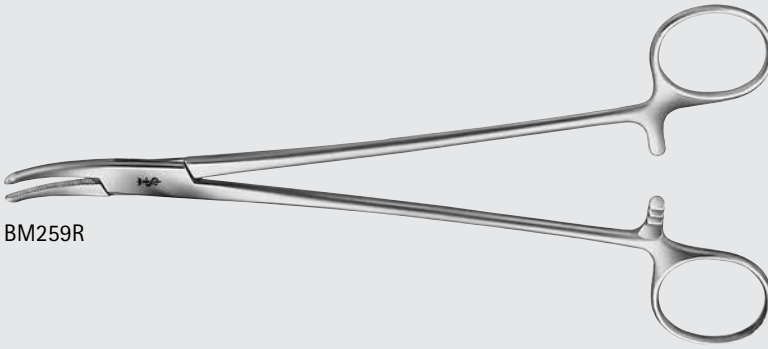

BM259R

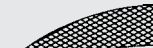

BM259R 1/1

### HEANEY Needle Holder

Catalog Number	Tip	Jaw	Length (in.)
BM259R	CVD	SERR	7 7/8

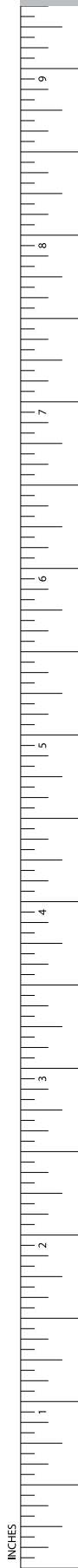

**JAMESON Needle Holder**

Catalog Number	Tip	Jaw	Length (in.)
BM270R	DEL	X-SERR	9

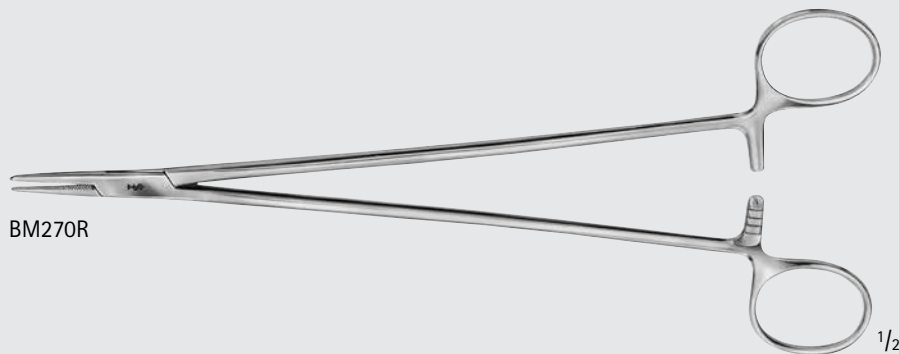

BM270R



BM270R

**WANGENSTEEN Needle Holder**

Catalog Number	Jaw	Length (in.)
BM272R	X-SERR	10 3/4

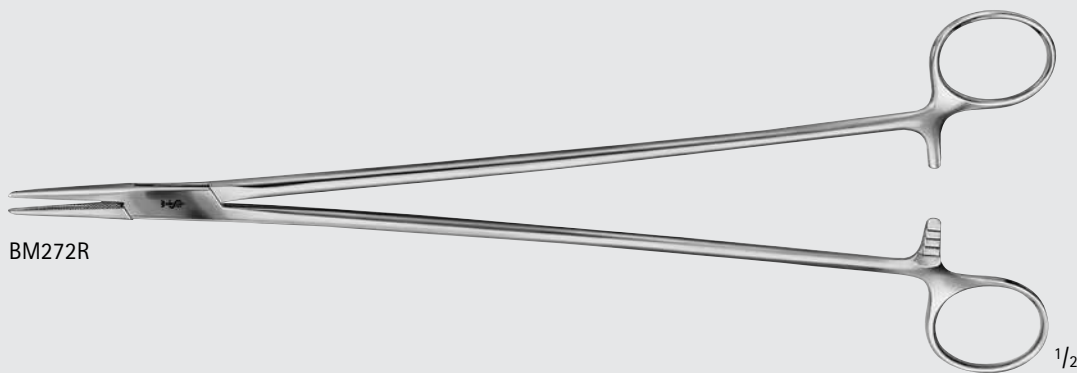

BM272R



BM272R

**MASSON Needle Holder**

Catalog Number	Jaw	Length (in.)
BM275R	X-SERR	10 1/2

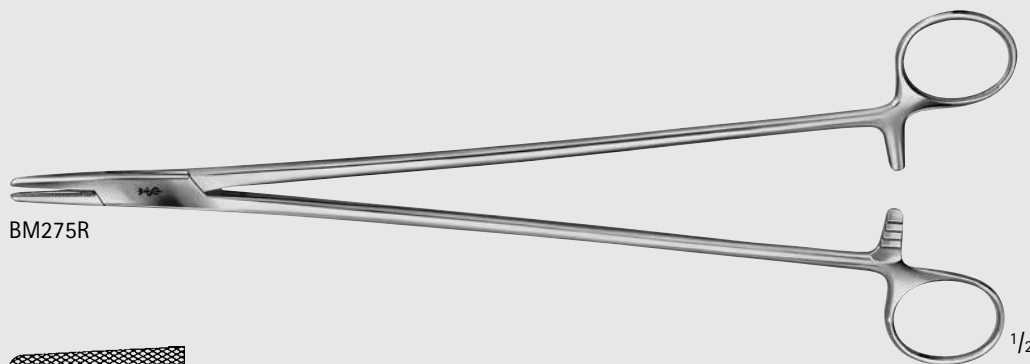

BM275R



BM275R

# General Surgery

## Needle Holders

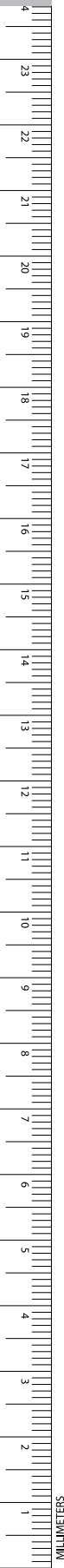

BM290R-BM291R

HEGAR-OLSEN Needle Holder/Scissors

Catalog Number	Jaw	Length (in.)
BM290R	SERR	5 1/2
BM291R	SERR	7 1/4

BM290R

BM291R

BM299R

GILLIES Needle Holder/Scissors

Catalog Number	Jaw	Length (in.)
BM299R	SERR	6 1/4

BM299R

# General Surgery

## DUROGRIP™ TC Needle Holders

Aesculap features Needle Holders with Tungsten Carbide (TC) inserts. A smooth jaw and three different serration patterns are available, depending on the size of the suture needle.

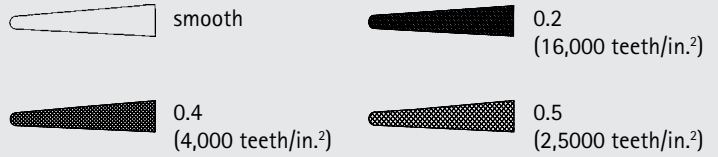
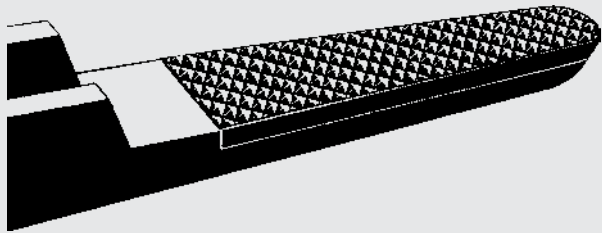

We recommend carbide inserts as follows:

Jaw Surface	Suture Material
Smooth	9/0 - 11/0
0.2 mm pitch of serration	6/0 - 10/0
0.4 mm pitch of serration	4/0 - 6/0
0.5 mm pitch of serration	up to 3/0



**DUROGRIP TC HELLBERG-KUPKA Needle Holder W/ Ergonomic Handle**

Catalog Number	Jaw	Length (in.)
BM320R	SERR	8 1/4

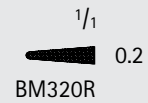

**DUROGRIP TC DERF Needle Holder**

Catalog Number	Jaw	Length (in.)
BM008R	SERR	4 3/4

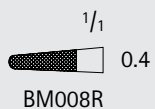

INCHES

# General Surgery

## DUROGRIP™ TC Needle Holders

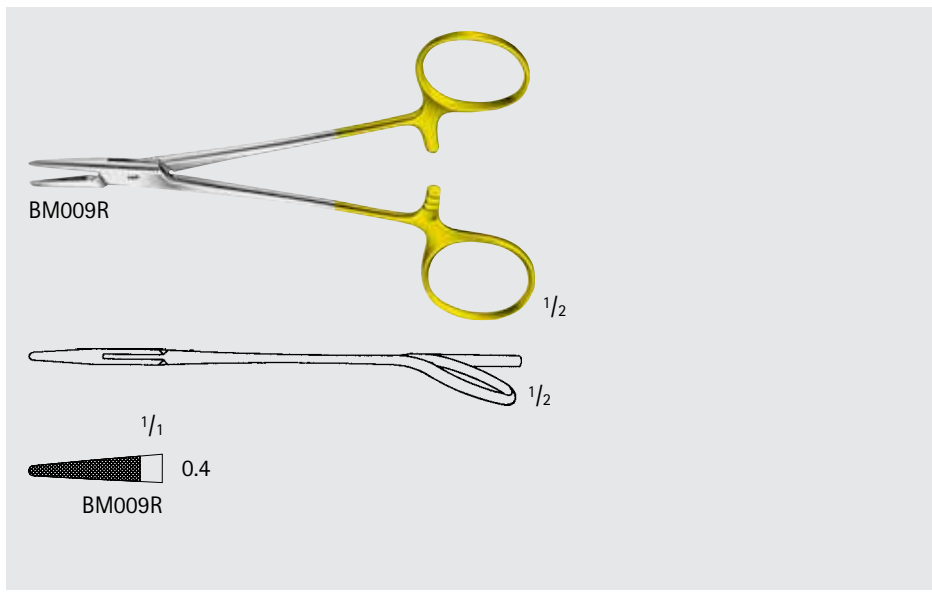
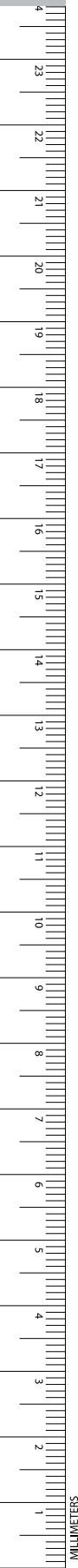

**DUROGRIP TC MASING Needle Holder**

Catalog Number	Jaw	Length (in.)
BM009R	SERR	5 1/8

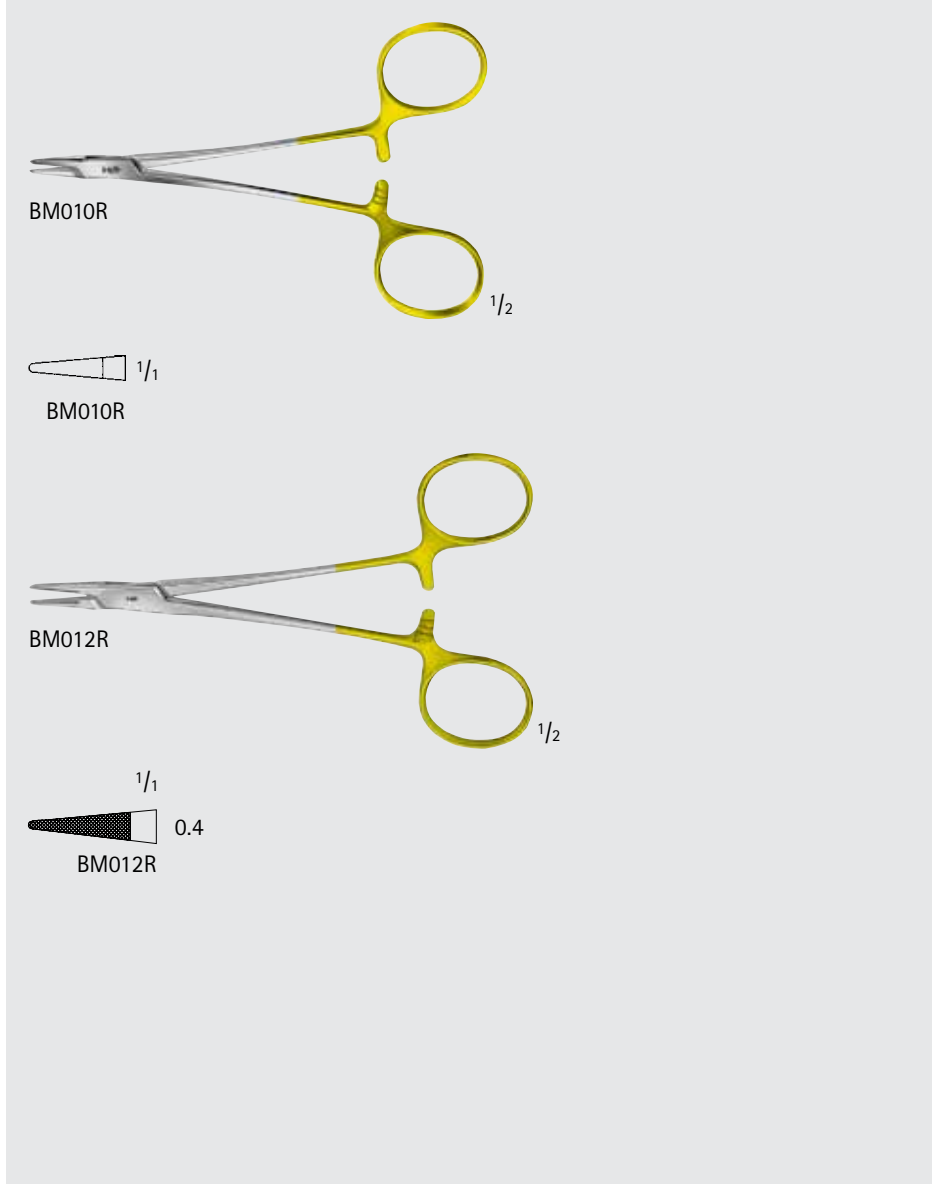

**DUROGRIP TC HALSEY Needle Holder**

Catalog Number	Jaw	Length (in.)
BM010R	SMOOTH	4 3/4
BM012R	SERR	5 1/8

**DUROGRIP TC CONVERSE Needle Holder**

Catalog Number	Jaw	Length (in.)
BM011R	SERR	5 1/8



BM011R

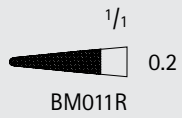

**DUROGRIP TC WEBSTER Needle Holder**

Catalog Number	Jaw	Length (in.)
BM014R	SMOOTH	5 1/8
BM024R	SERR	5 1/8

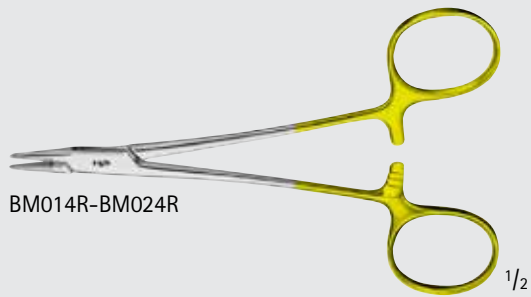

BM014R-BM024R

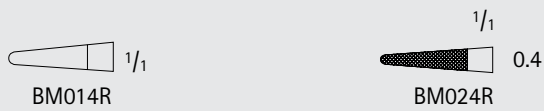

**DUROGRIP TC BAUMGARTNER Needle Holder**

Catalog Number	Jaw	Length (in.)
BM015R	SERR	5 3/4

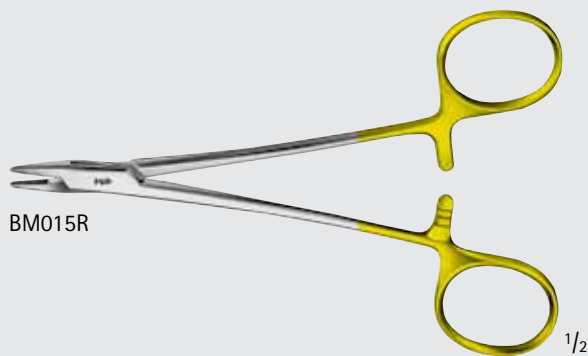

BM015R

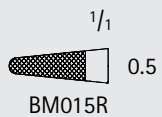

# General Surgery

## DUROGRIP™ TC Needle Holders



MG522R

1/2

1/1

MG522R

Catalog Number	Jaw	Length (in.)
MG522R	SERR	7

BM020R-BM023R

1/1 0.4

BM020R

1/1 0.4

BM023R

Catalog Number	Jaw	Length (in.)
BM020R	SERR	7
BM023R	SERR	10 1/4

BM013R

1/2

1/1 0.4

BM013R

Catalog Number	Jaw	Length (in.)
BM013R	SERR	6

General Surgery  
DUROGRIP™ TC Needle Holders

GENERAL SURGERY

DUROGRIP TC CRILE-WOOD Needle Holder

Catalog Number	Jaw	Length (in.)
BM016R	SERR	5 3/4
BM017R	SERR	7 1/4
BM019R	SERR	7 7/8
BM030R	SERR	10 5/8
BM021R	SERR	12
MB604R	SERR	14
BM029R	SMOOTH	6



BM016R, BM021R, MB604R

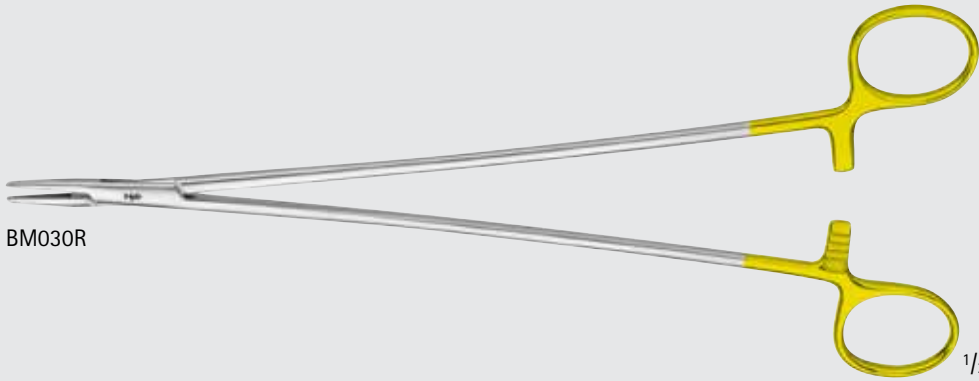
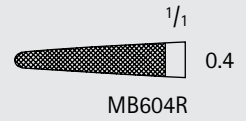
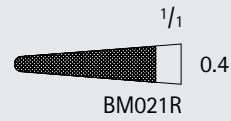
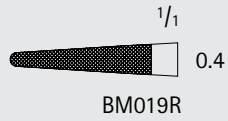
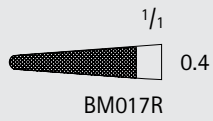
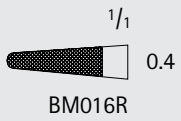

BM030R

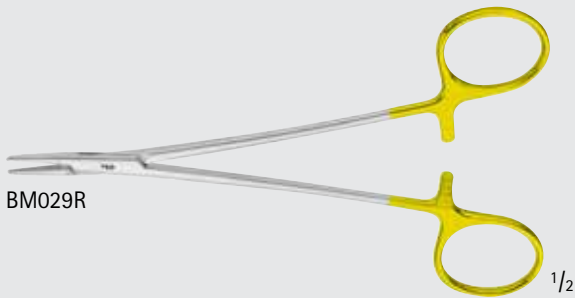
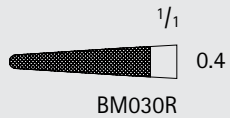

BM029R

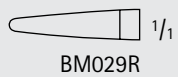

INCHES

# General Surgery

## DUROGRIP™ TC Needle Holders

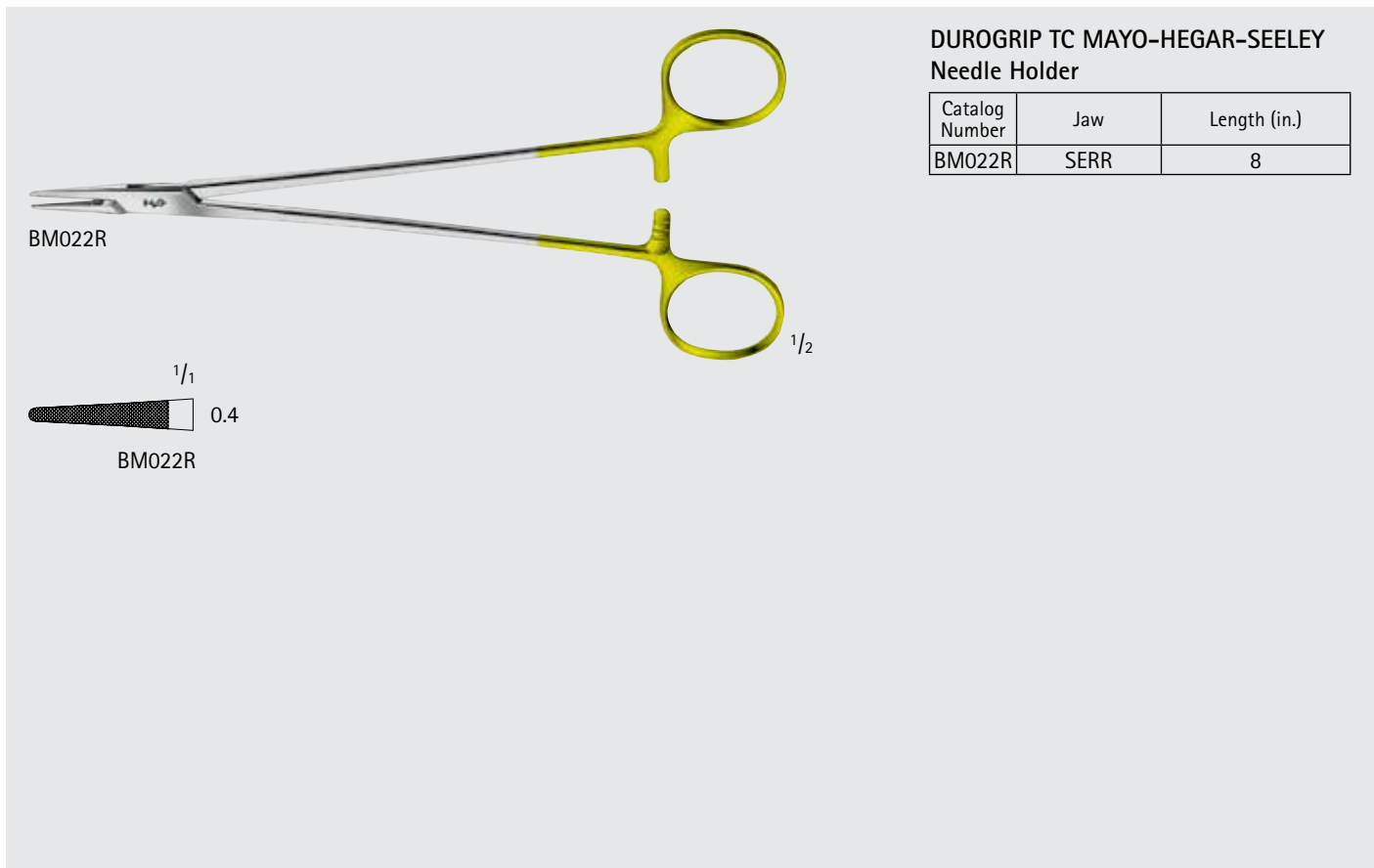
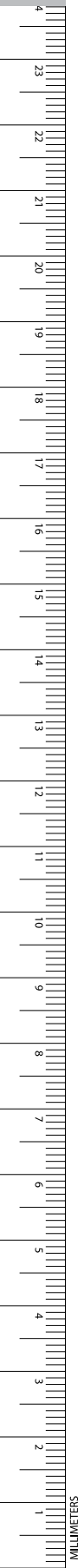

**DUROGRIP TC MAYO-HEGAR-SEELEY Needle Holder**

Catalog Number	Jaw	Length (in.)
BM022R	SERR	8

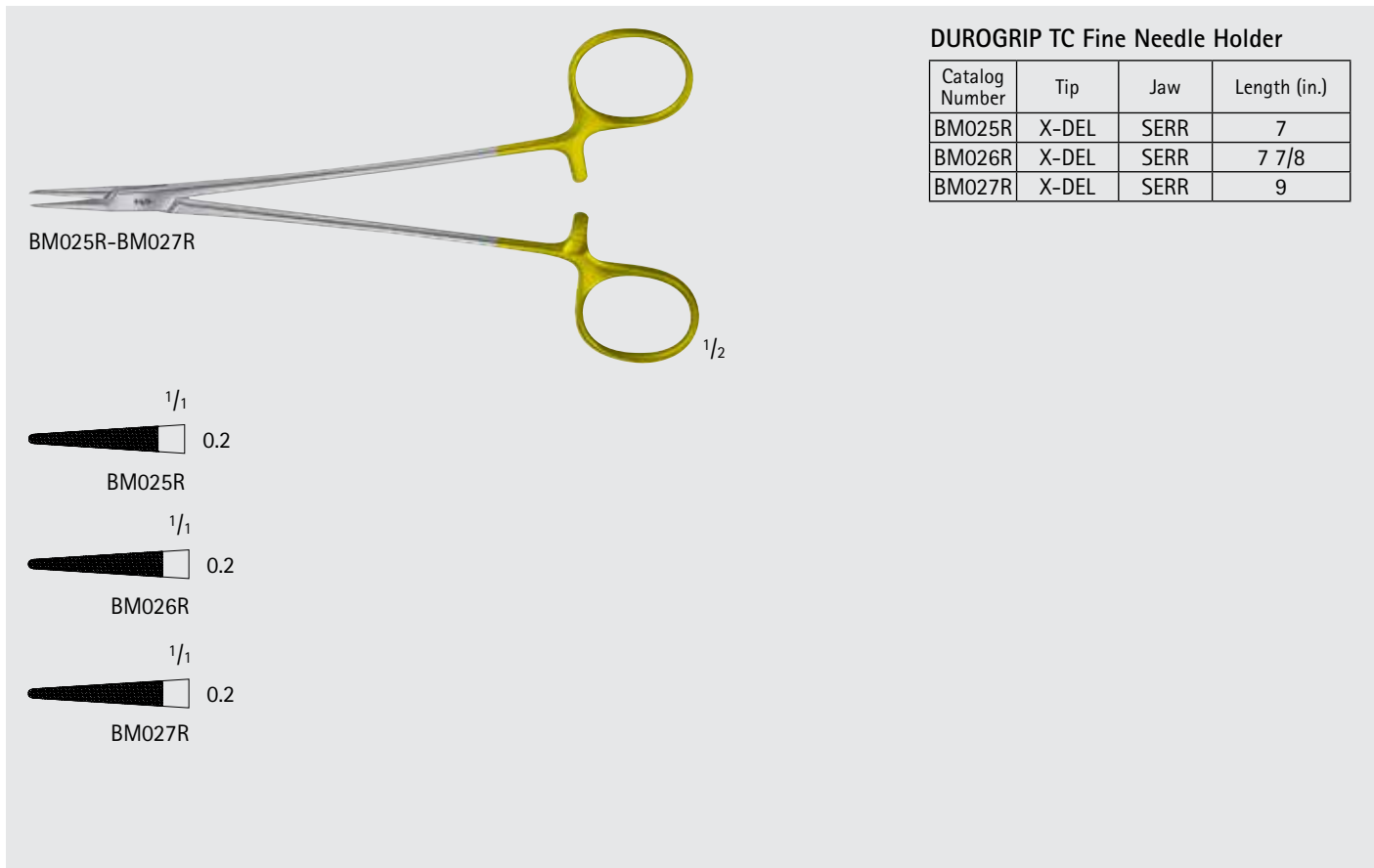

**DUROGRIP TC Fine Needle Holder**

Catalog Number	Tip	Jaw	Length (in.)
BM025R	X-DEL	SERR	7
BM026R	X-DEL	SERR	7 7/8
BM027R	X-DEL	SERR	9

DUROGRIP TC DEBAKEY Needle Holder

Catalog Number	Tip	Jaw	Length (in.)
BM032R	DEL	SERR	6
BM033R	DEL	SERR	6 1/2
BM035R	DEL	SERR	7
BM034R	DEL	SERR	8 1/4
BM036R	DEL	SERR	9
BM037R	DEL	SERR	10 1/4
BM038R	DEL	SERR	12
BM063R	X-DEL	SERR	6 1/2
BM064R	X-DEL	SERR	8 1/4
BM040R	X-DEL	SERR	12

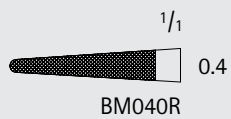
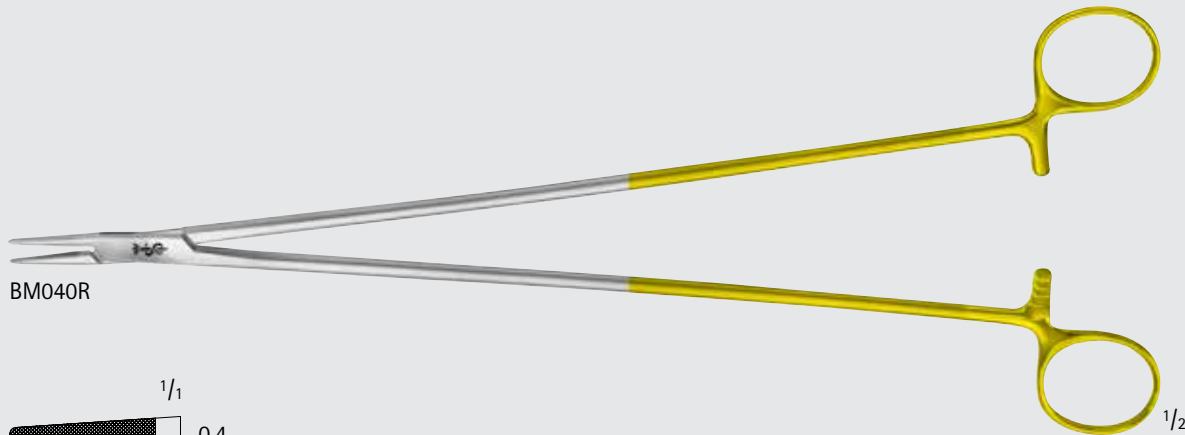
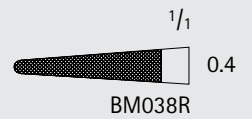
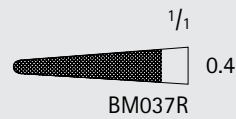
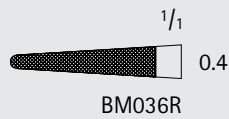
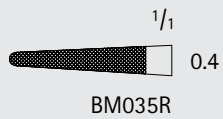
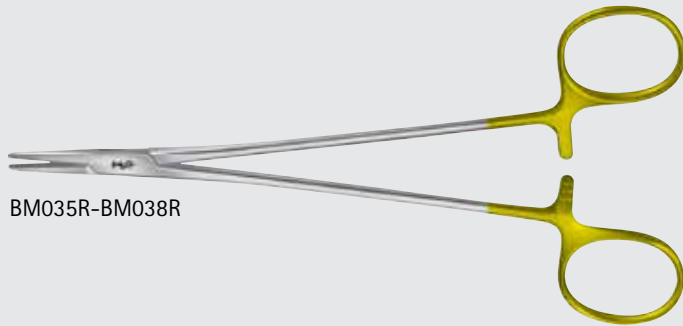
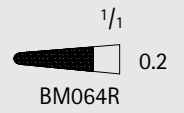
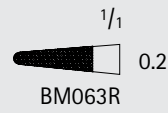
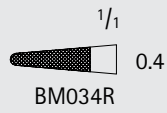
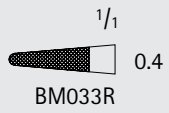
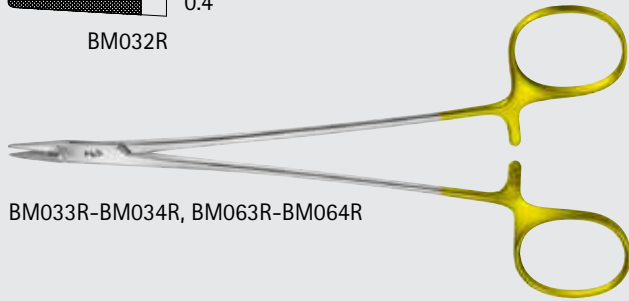
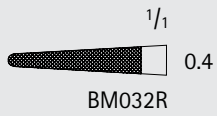
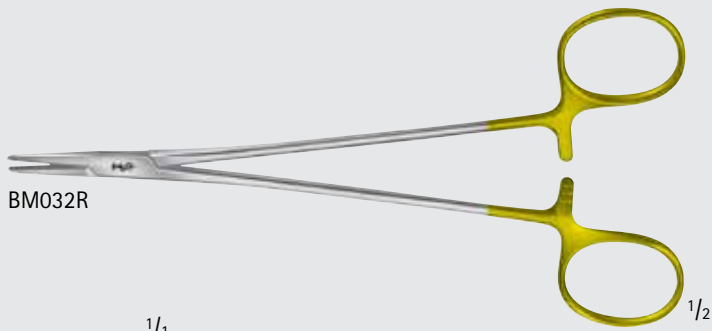

# General Surgery

## DUROGRIP™ TC Needle Holders

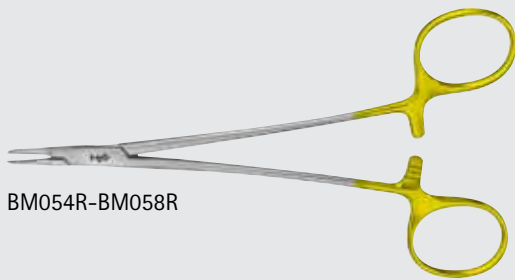

BM054R-BM058R

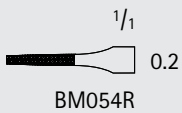

BM054R



BM055R



BM056R

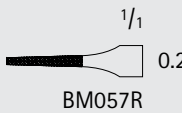

BM057R

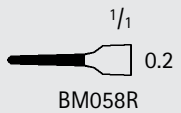

BM058R

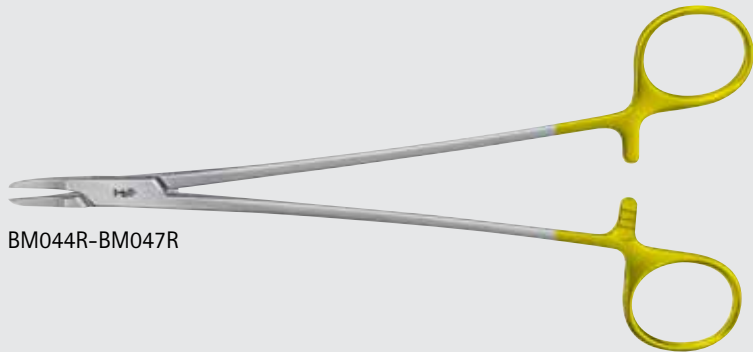

BM044R-BM047R

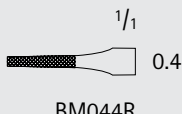

BM044R



BM045R

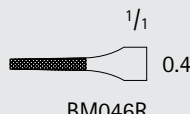

BM046R

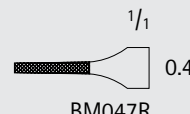

BM047R

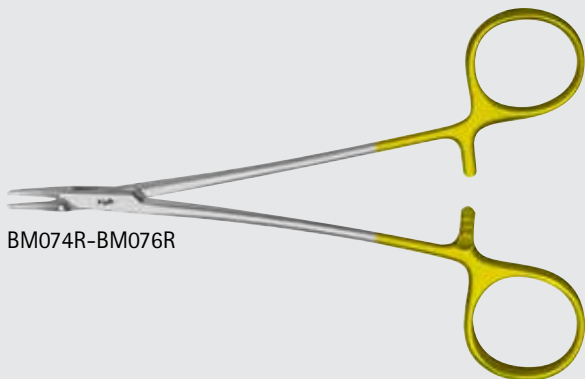

BM074R-BM076R

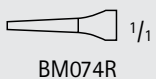

BM074R

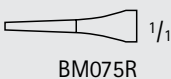

BM075R

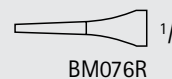

BM076R

### DUROGRIP TC RYDER Needle Holder

Catalog Number	Tip	Jaw	Length (in.)
BM054R	X-DEL	SERR	5 1/4
BM055R	X-DEL	SERR	6 1/8
BM056R	X-DEL	SERR	6 7/8
BM057R	X-DEL	SERR	8 1/4
BM058R	X-DEL	SERR	9
BM044R	DEL	SERR	5 1/4
BM045R	DEL	SERR	6 7/8
BM046R	DEL	SERR	7 3/4
BM047R	DEL	SERR	10 1/2
BM074R	DEL	SMOOTH	6
BM075R	DEL	SMOOTH	7
BM076R	DEL	SMOOTH	8 7/8

DUROGRIP TC FRENCH Eye Needle Holder

Catalog Number	Jaw	Length (in.)
MB606R	SERR	6 1/4
MB607R	SERR	7 1/4
MB611R	SERR	8
MB612R	SERR	9 1/4

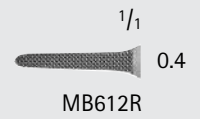
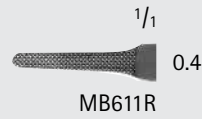
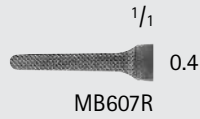
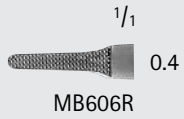
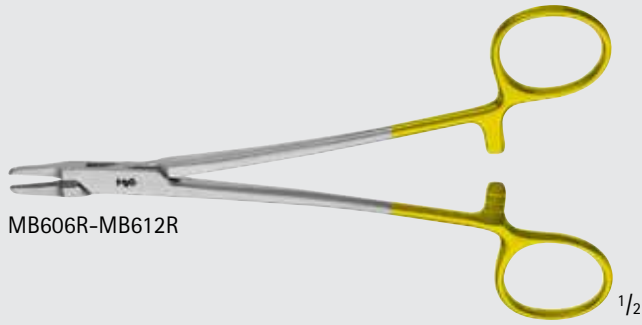

# General Surgery

## DUROGRIP™ TC Needle Holders



BM065R-BM070R

### DUROGRIP TC MAYO-HEGAR Needle Holder

Catalog Number	Jaw	Length (in.)
BM065R	SERR	6
BM066R	SERR	7 1/4
BM067R	SERR	8
BM068R	SERR	9 1/4
BM070R	SERR	10 1/2
BM069R	SERR	12
MB617R	SERR	14

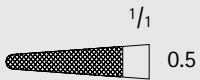

BM065R



BM066R



BM067R



BM068R



BM070R

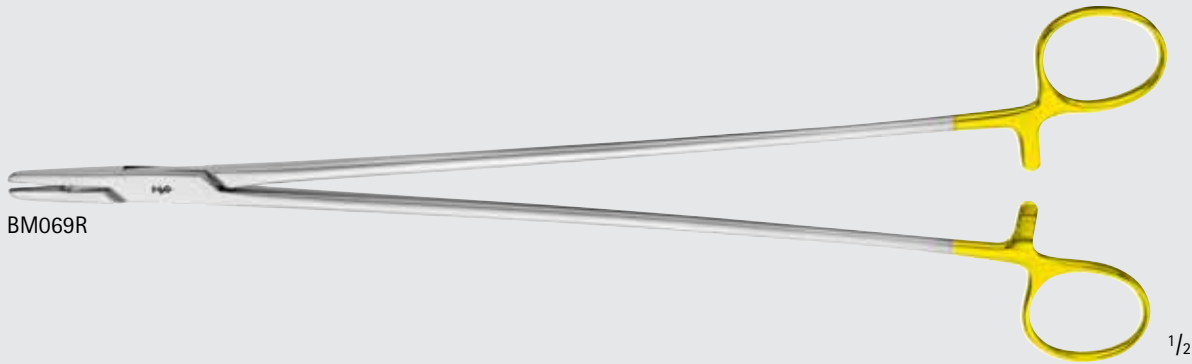

BM069R



BM069R

1/2

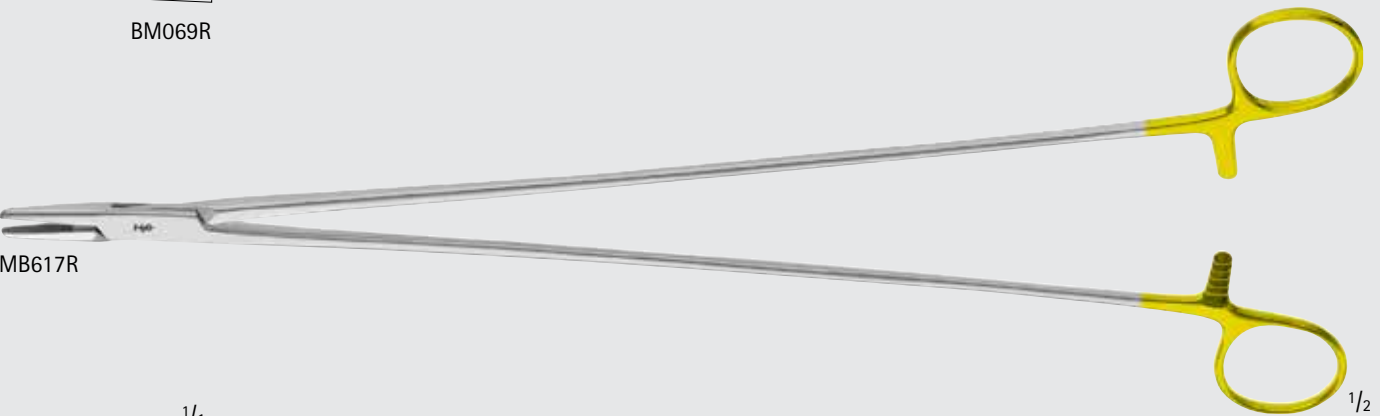

MB617R



MB617R

1/2

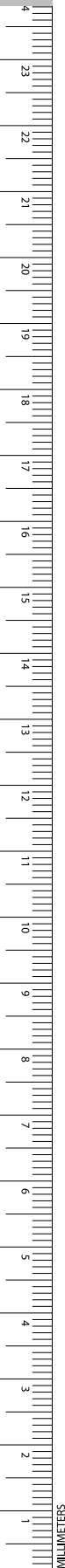

DUROGRIP TC HEGAR Needle Holder

Catalog Number	Tip	Jaw	Length (in.)
BM077R	HEAVY	SERR	8
BM078R	HEAVY	SERR	9 1/2

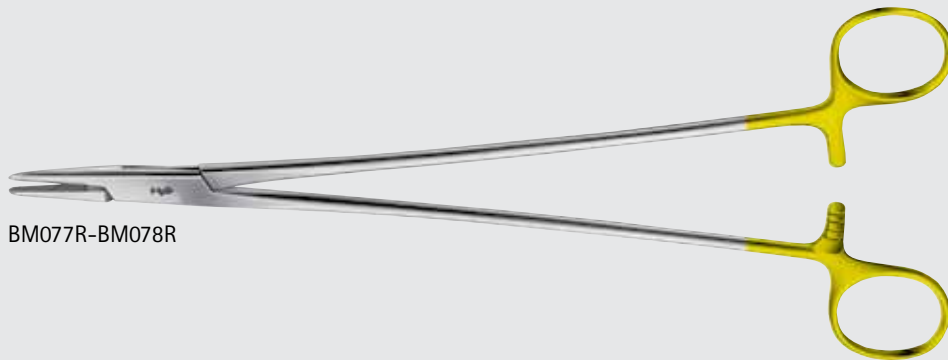

BM077R-BM078R

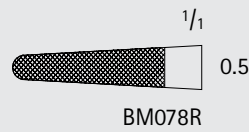
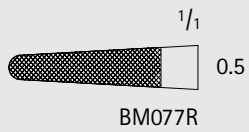

DUROGRIP TC WANGENSTEEN Needle Holder

Catalog Number	Jaw	Length (in.)
BM042R	SERR	10 3/4

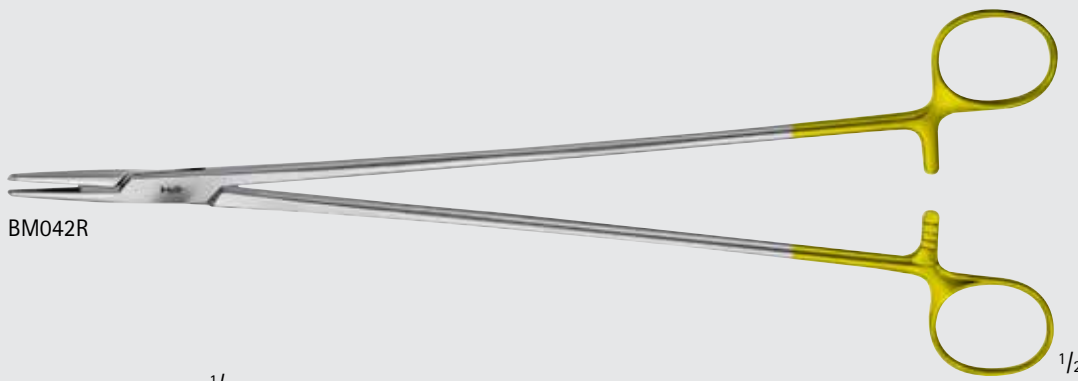

BM042R

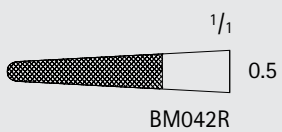

# General Surgery

## DUROGRIP™ TC Needle Holders

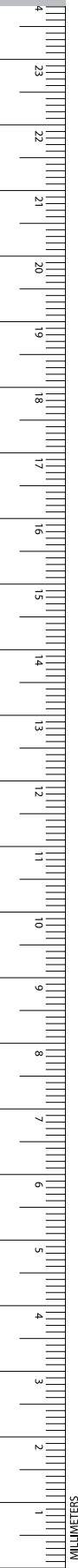

### DUROGRIP TC MASSON Needle Holder

Catalog Number	Jaw	Length (in.)
BM090R	SERR	10 1/2

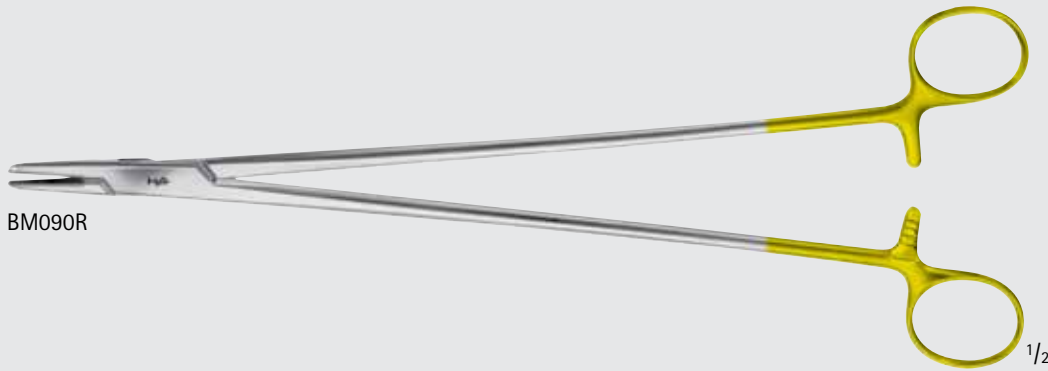

BM090R

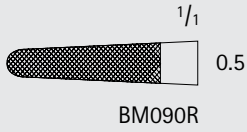

BM090R

### DUROGRIP TC MAYO-MASSON Needle Holder

Catalog Number	Jaw	Length (in.)
MB918R	SERR	16

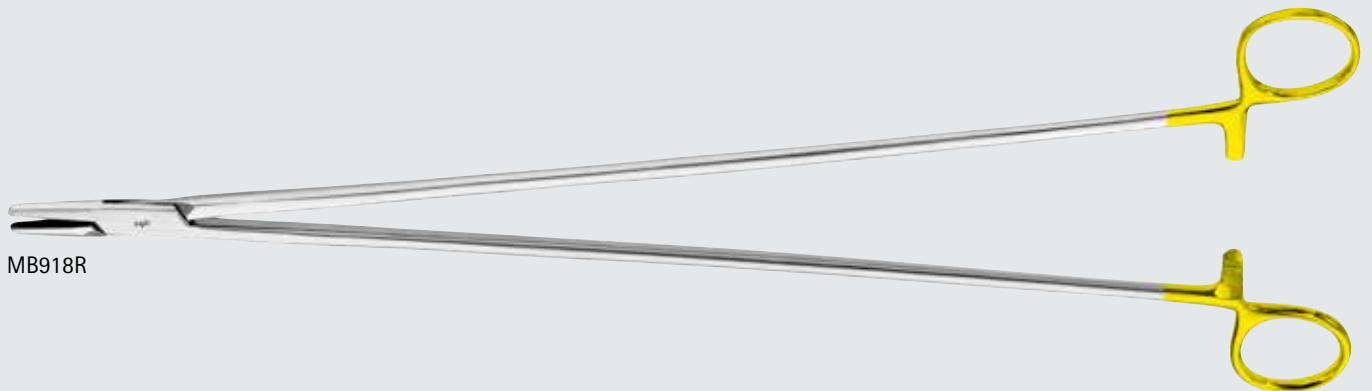

MB918R



MB918R

# General Surgery

## DUROGRIP™ TC Needle Holders

GENERAL SURGERY

### DUROGRIP TC HEANEY Needle Holder

Catalog Number	Tip	Jaw	Length (in.)
BM081R	CVD	SERR	7 7/8
BM084R	CVD	SERR	10 1/4

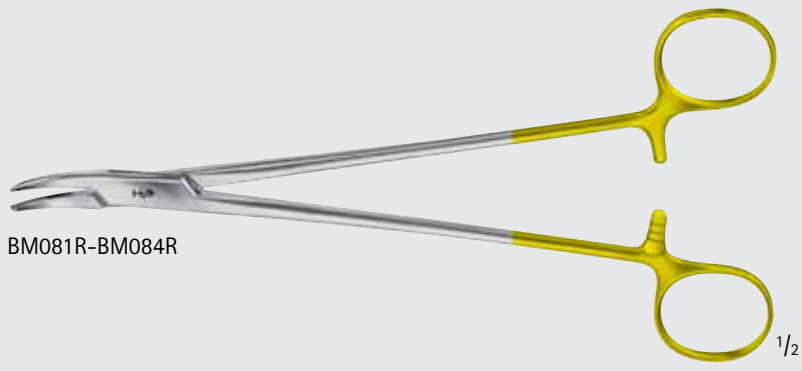

BM081R-BM084R

1/2

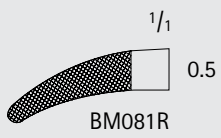

BM081R

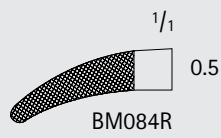

BM084R

### DUROGRIP TC MUELLER Needle Holder

Catalog Number	Tip	Jaw	Length (in.)
BM089R	CVD	SERR	14 1/4

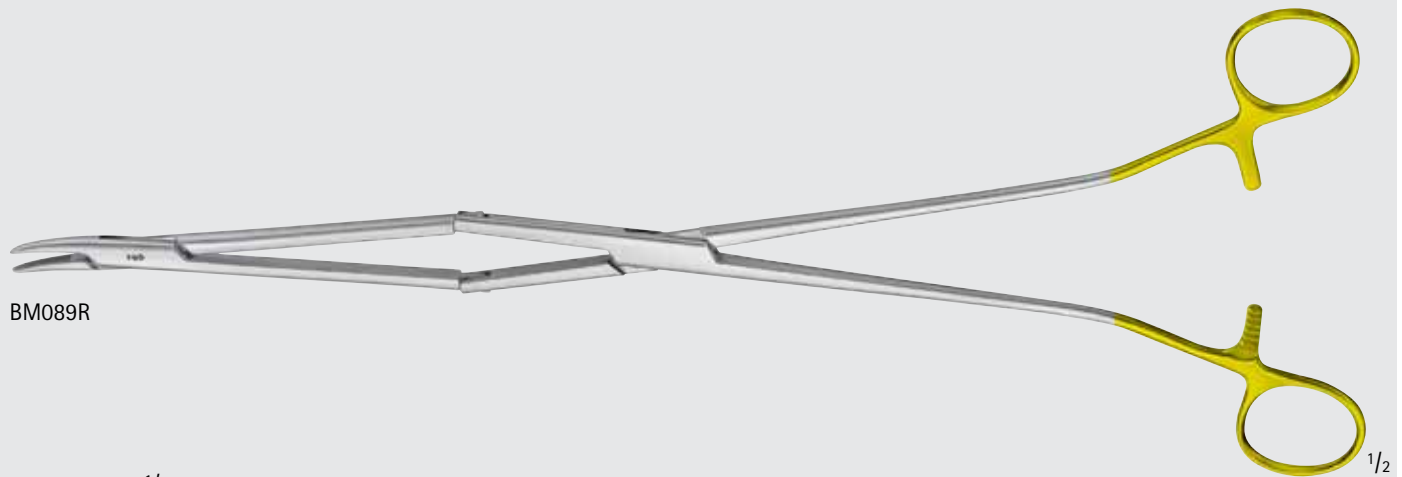

BM089R

1/2

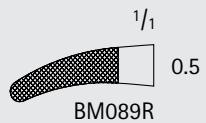

BM089R



# General Surgery

## DUROGRIP™ TC Needle Holders



### DUROGRIP TC FINOCHIETTO Needle Holder

Catalog Number	Tip	Jaw	Length (in.)
BM092R	ANG	SERR	10 1/2

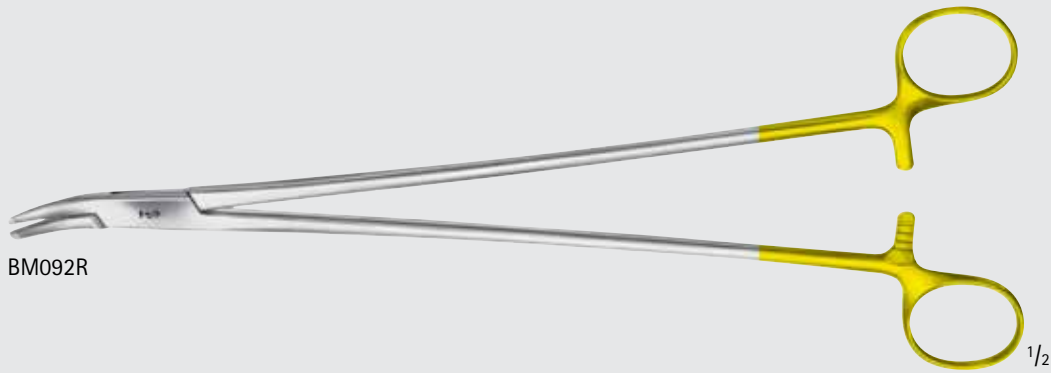

BM092R

1/2

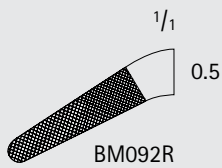

BM092R

### DUROGRIP TC STRATTE Needle Holder

Catalog Number	Tip	Jaw	Length (in.)
BM095R	CVD	SERR	8 1/4
BM096R	CVD	SERR	9

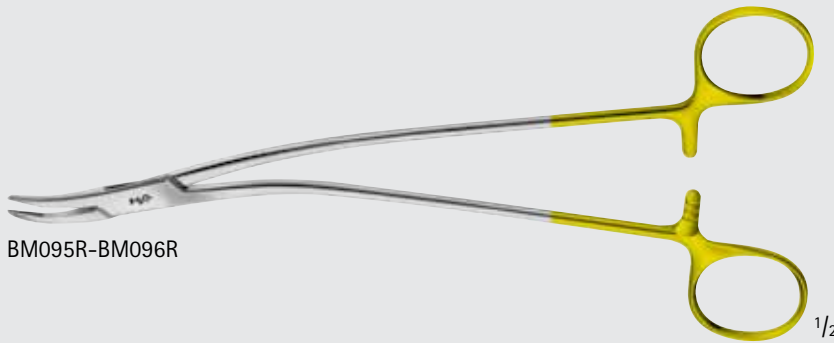

BM095R-BM096R

1/2

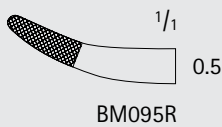

BM095R

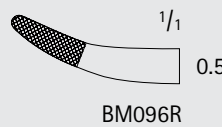

BM096R

DUROGRIP TC Wire Twister

Catalog Number	Tip	Jaw	Length (in.)
BM110R	ROUND	SERR	6 1/8
BM111R	SQUARE	SERR	6

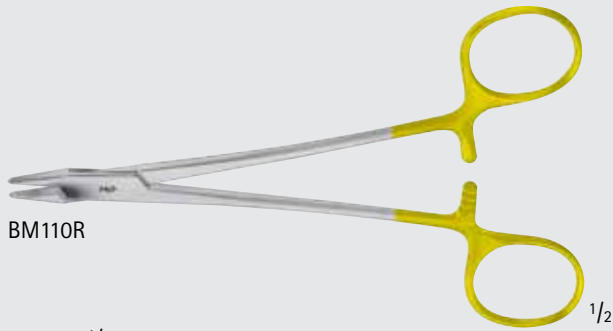

BM110R

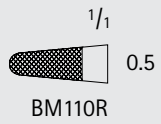

BM111R

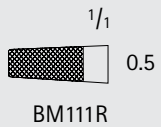

DUROGRIP TC BAUMGARTNER Wire Twister

Catalog Number	Tip	Jaw	Length (in.)
BM112R	SQUARE	SERR	7 7/8

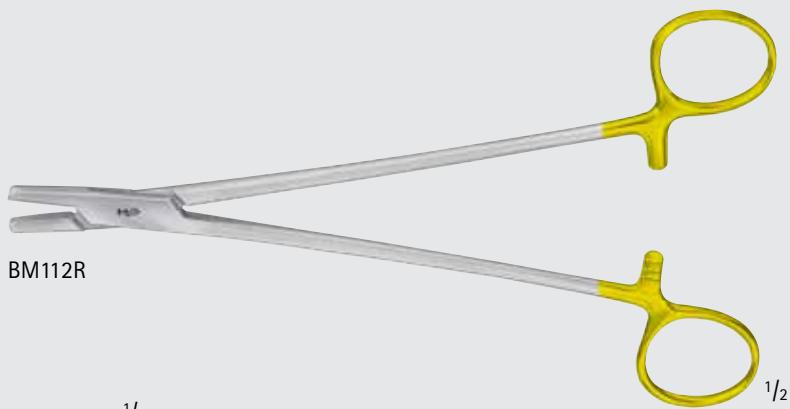

BM112R

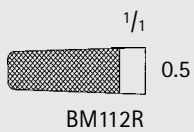

INCHES

# General Surgery

## DUROGRIP™ TC Needle Holders

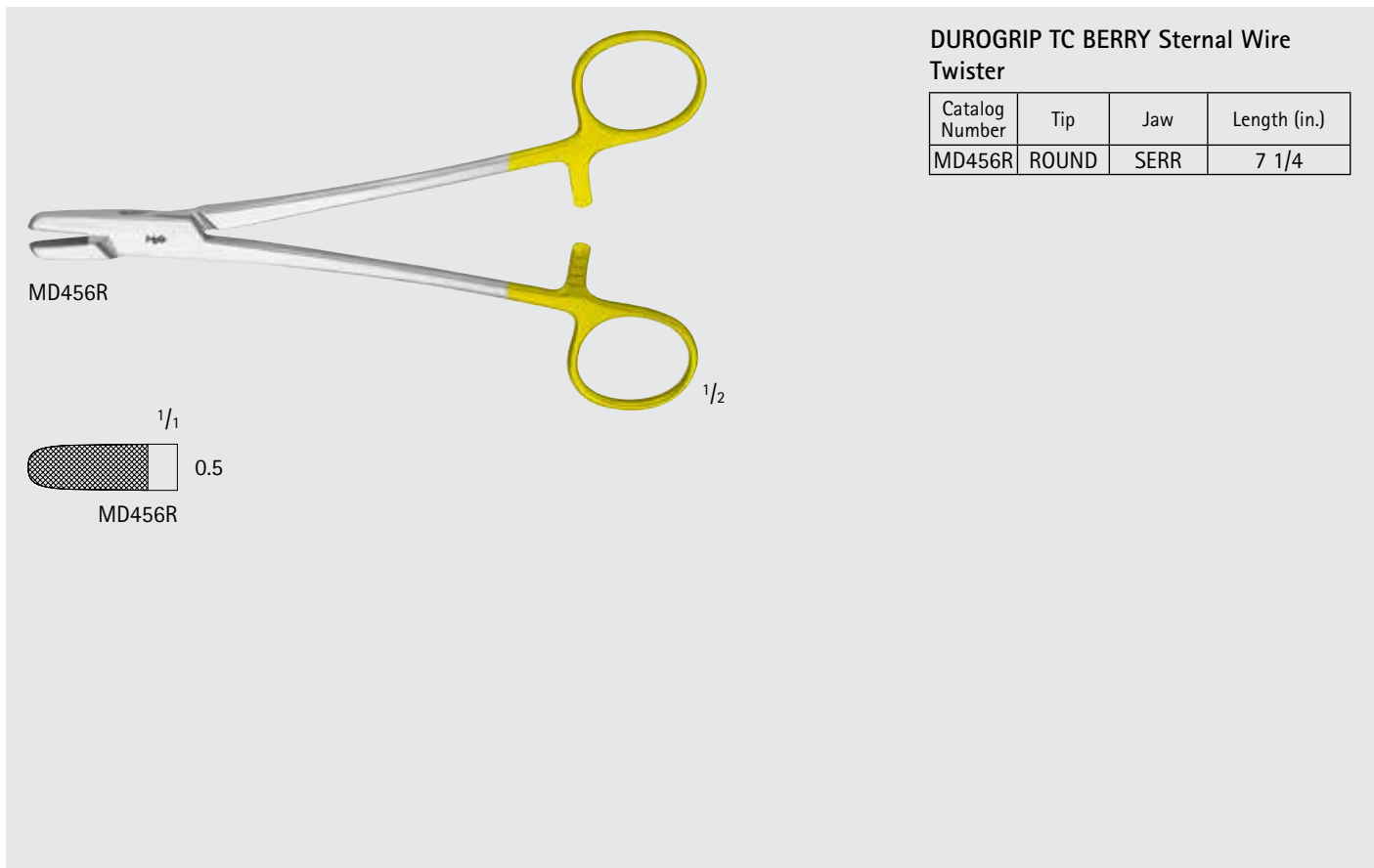
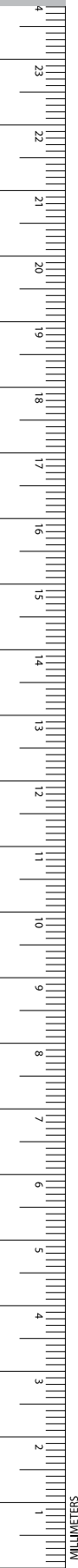

**DUROGRIP TC BERRY Sternal Wire Twister**

Catalog Number	Tip	Jaw	Length (in.)
MD456R	ROUND	SERR	7 1/4

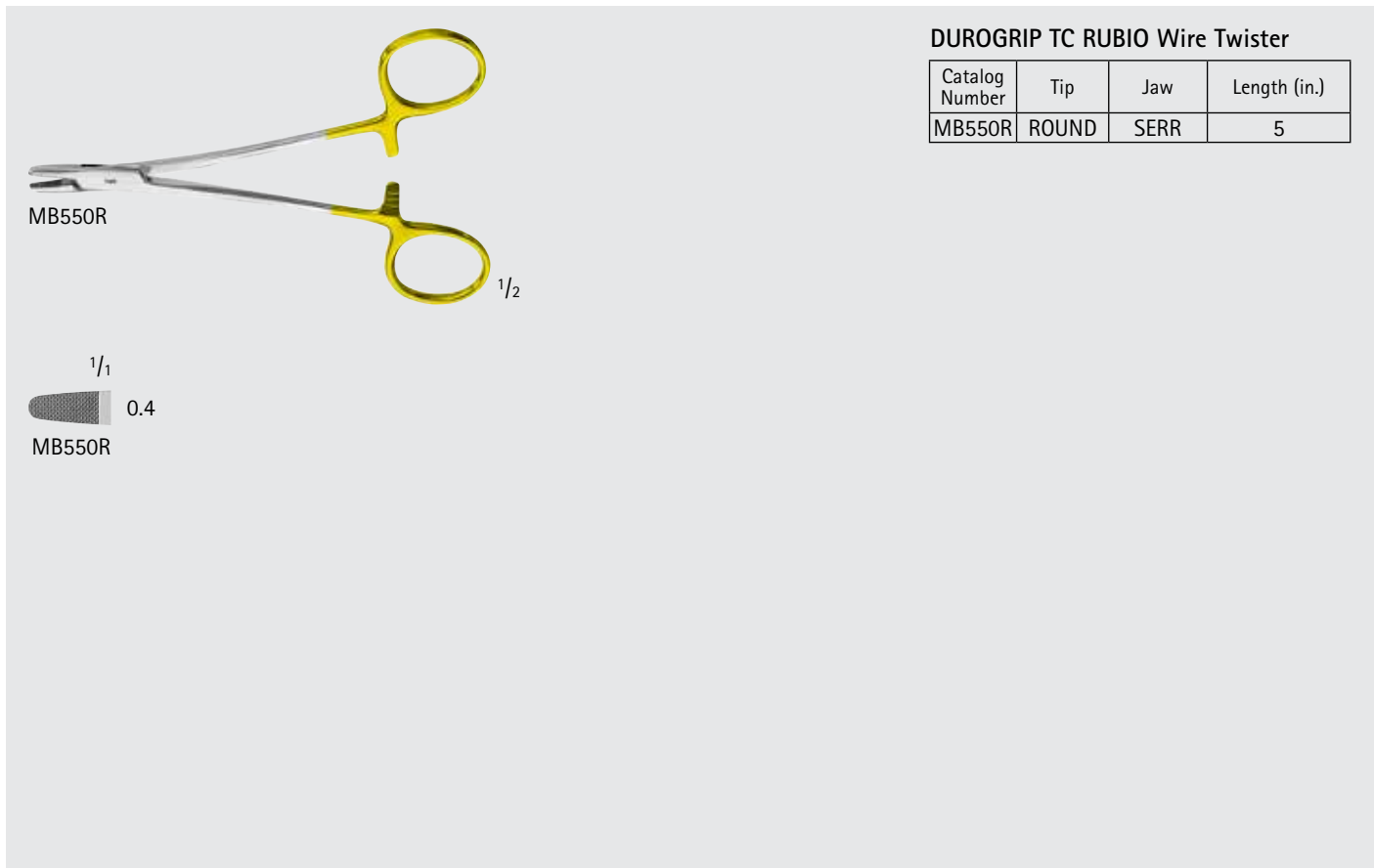

**DUROGRIP TC RUBIO Wire Twister**

Catalog Number	Tip	Jaw	Length (in.)
MB550R	ROUND	SERR	5

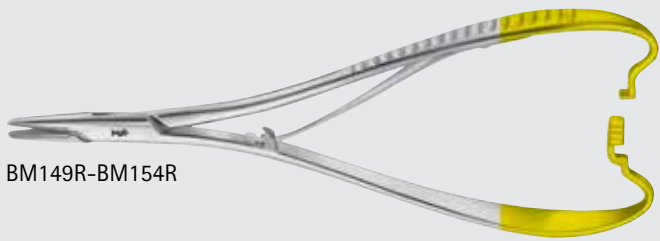

BM149R-BM154R

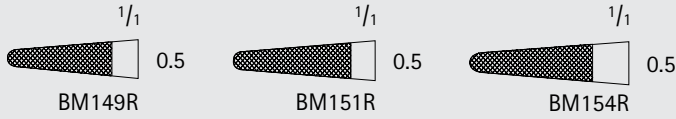

DUROGRIP TC MATHIEU Needle Holder

Catalog Number	Jaw	Length (in.)
BM149R	SERR	5 1/2
BM151R	SERR	6 1/2
BM154R	SERR	7 7/8

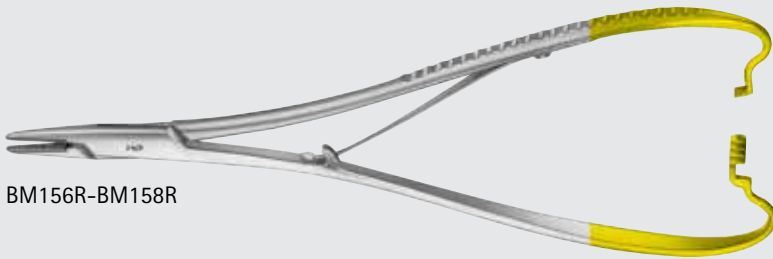

BM156R-BM158R



DUROGRIP TC MATHIEU Needle Holder, Heavy

Catalog Number	Jaw	Length (in.)
BM156R	SERR	7 7/8
BM158R	SERR	9 5/8



INCHES

# General Surgery

## Needle Cases



BL907R

### Needle Case, Rectangle

Catalog Number	Dimensions (mm)
BL907R	70 x 53 x 9



BL930R-BL933R



BL931R-BL933R

### Needle Case, Round

Catalog Number	Item	Dimensions (mm)
BL930R	COMPLETE NEEDLE CASE W/ INTERIOR BOX	65 x 16
BL931R	INTERIOR BOX ONLY	62 x 12
BL933R	INTERIOR BOX ONLY	90 x 12



BL941R

### Needle Case, With 7 Sections

Catalog Number	Dimensions (mm)
BL941R	150 x 90 x 10

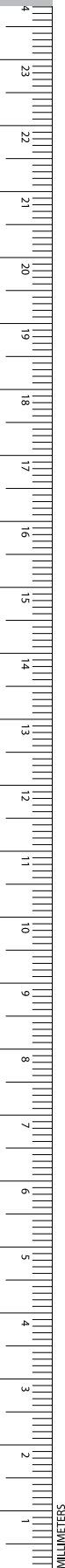



BM822R-BM824R

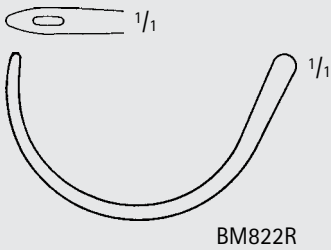

BM822R

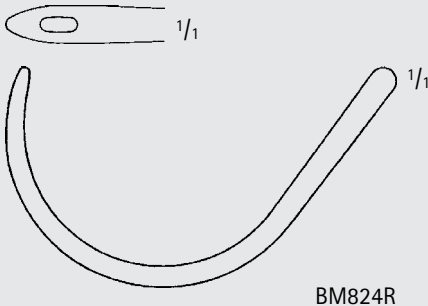

BM824R



BM749R, BM781R, BM807R, BM809R, BM811R, BM813R



BM781R

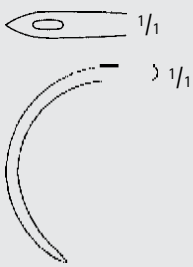

BM749R

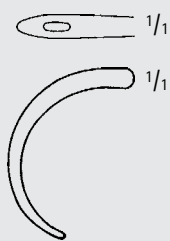

BM809R

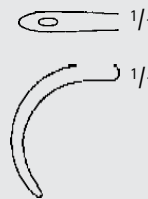

BM807R

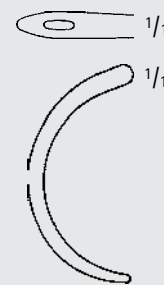

BM811R

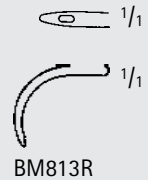

BM813R

DESCHAMPS Needle

Catalog Number	Hand Orientation	Tip	Length (in.)
BM822R	RIGHT	BLUNT, 3.5 MM	9 1/2
BM824R	RIGHT	BLUNT, 5 MM	11
BM781R	LEFT	SHARP, 2 MM	8 1/4
BM749R	LEFT	SHARP, 3.5 MM	8 1/2
BM809R	LEFT	BLUNT, 2.5 MM	8 1/4
BM807R	LEFT	BLUNT, 2.5 MM	8 1/2
BM811R	LEFT	BLUNT, 3.5 MM	8 1/2
BM813R	LEFT	STEEP, BLUNT, 2 MM	8 7/8



# General Surgery

## Ligature Needles

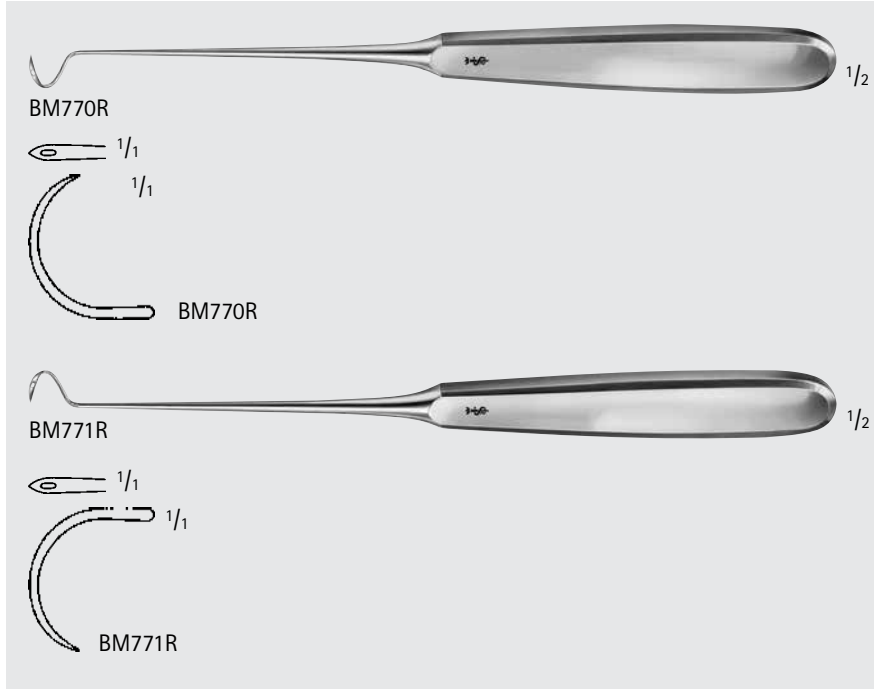
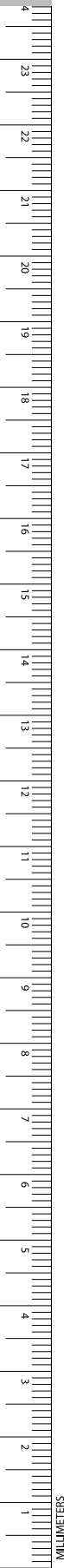

### HURD Needle

Catalog Number	Hand Orientation	Tip	Length (in.)
BM770R	RIGHT	SHARP	8 1/4
BM771R	LEFT	SHARP	8 1/4

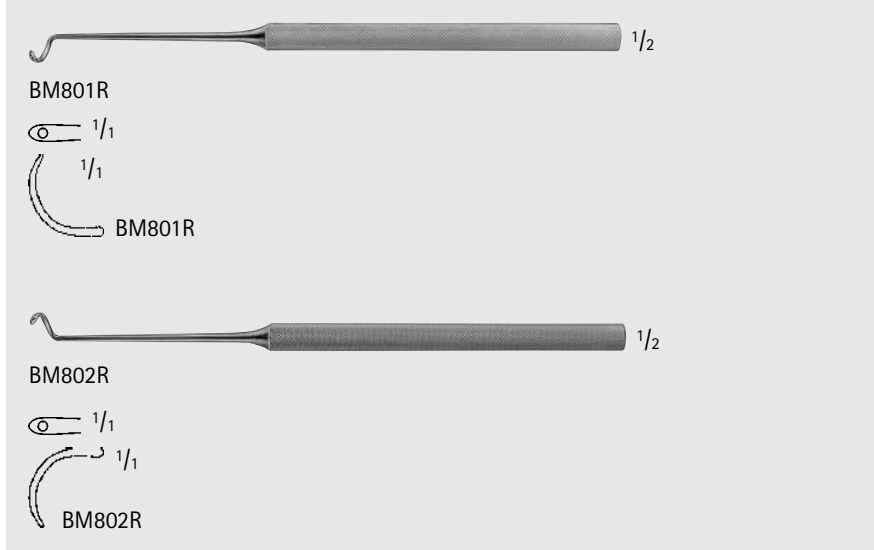

### KRONECKER Needle

Catalog Number	Hand Orientation	Tip	Length (in.)
BM801R	RIGHT	BLUNT	6 1/8
BM802R	LEFT	BLUNT	6 1/8

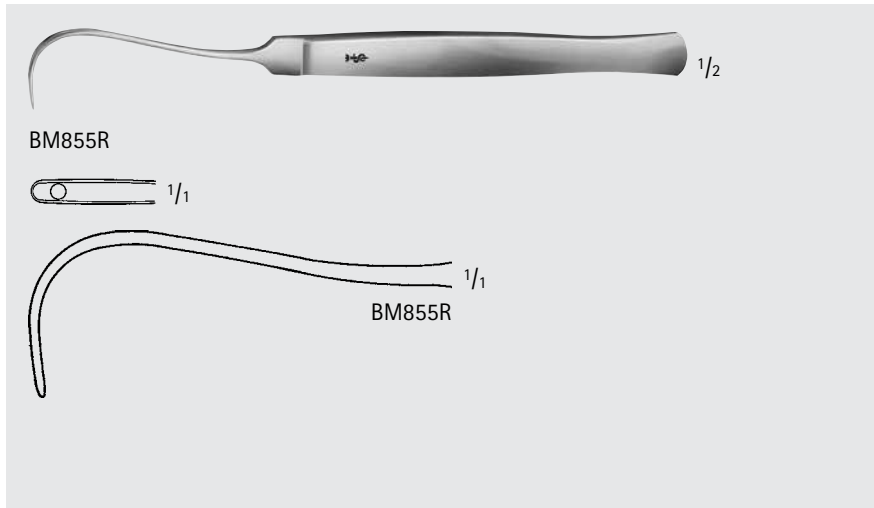

### SYME Suture Needle

Catalog Number	Tip	Length (in.)
BM855R	BLUNT	6 3/4

Monopolar Diathermi Forceps, Insulated

Catalog Number	Length (in.)
GK033R	13 3/4



GK033R



Dressing Forceps, Standard Patterns

Catalog Number	Tip	Length (in.)
BD043R	SERR	4 1/2
BD045R	SERR	5 1/8
BD047R	SERR	5 3/4
BD049R	SERR	6 1/4
BD050R	SERR	7
BD051R	SERR	7 7/8
BD052R	SERR	9 3/4
BD053R	SERR	11 3/4



BD043R-BD053R

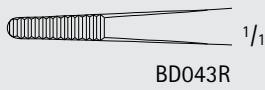

BD043R

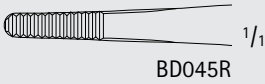

BD045R

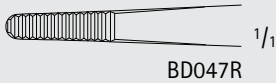

BD047R

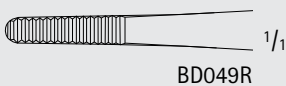

BD049R

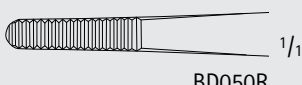

BD050R

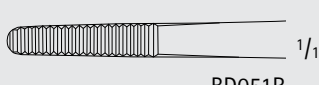

BD051R

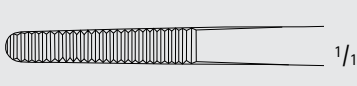

BD052R

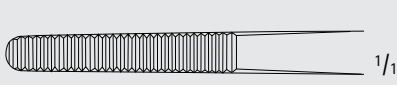

BD053R

Dressing Forceps, Extra Wide

Catalog Number	Tip	Length (in.)
BD077R	SERR	5 3/4



BD077R

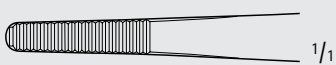

BD077R



INCHES

# General Surgery

## Dressing and Tissue Forceps



BD023R-BD033R

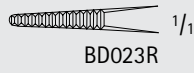

BD023R

1/1

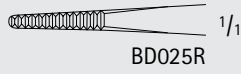

BD025R

1/1



BD027R

1/1



BD029R

1/1

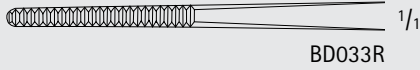

BD033R

1/1



BD035R-BD037R

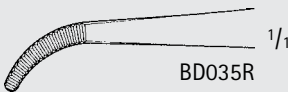

BD035R

1/1

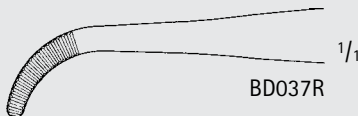

BD037R

1/1

### Dressing Forceps, Delicate

Catalog Number	Tip	Length (in.)
BD023R	STR, SERR	4 1/2
BD025R	STR, SERR	5 1/8
BD027R	STR, SERR	5 3/4
BD029R	STR, SERR	6 1/4
BD033R	STR, SERR	12
BD035R	CVD, SERR	5 1/8
BD037R	CVD, SERR	5 1/2



BD210R

1/2

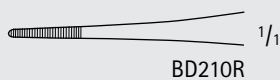

BD210R

1/1

### Dressing Forceps, Extra Delicate

Catalog Number	Tip	Length (in.)
BD210R	SERR	4 1/2

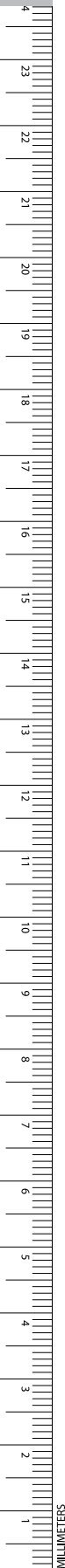

Tissue Forceps, Delicate

Catalog Number	Tip	Teeth	Length (in.)
BD533R	STR	1 x 2	4 1/2
BD535R	STR	1 x 2	5 1/8
BD537R	STR	1 x 2	5 3/4
BD539R	STR	1 x 2	6 1/4
BD540R	STR	1 x 2	7
BD541R	STR	1 x 2	7 7/8
BD542R	STR	1 x 2	9 3/4
BD543R	STR	1 x 2	11 3/4
MB803R	STR	2 x 3	4 1/2
BD575R	STR	2 x 3	5 1/8
BD577R	STR	2 x 3	5 3/4
BD579R	STR	2 x 3	6 1/4
BD580R	STR	2 x 3	7
BD581R	STR	2 x 3	7 7/8
BD587R	STR	3 x 4	5 3/4
BD589R	STR	3 x 4	6 1/4
BD591R	STR	3 x 4	7 7/8
BD527R	CVD	1 x 2	5 3/4

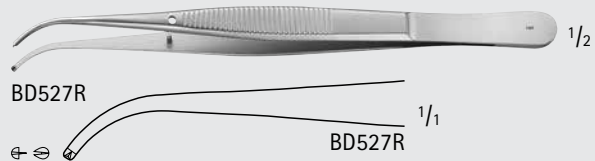
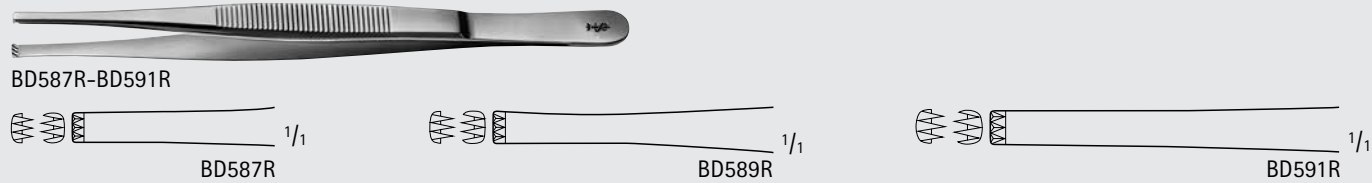
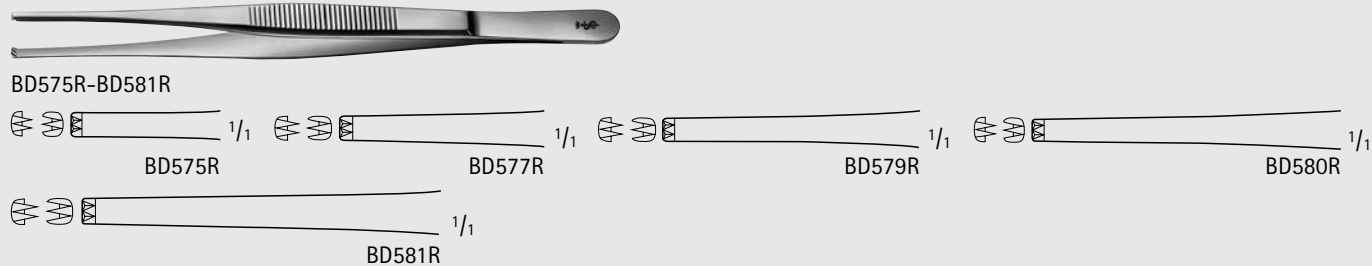
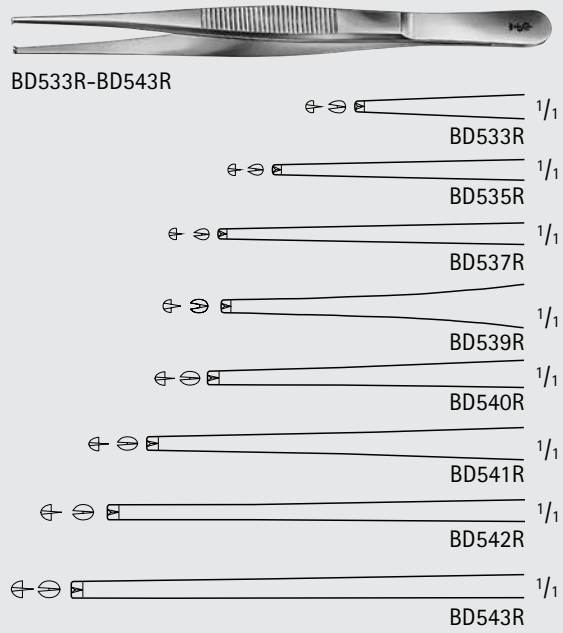

Tissue Forceps, Medium

Catalog Number	Teeth	Length (in.)
BD547R	1 x 2	5 3/4
BD549R	1 x 2	6 1/4

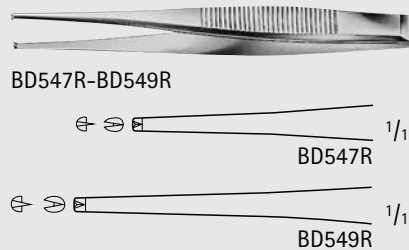

# General Surgery

## Dressing and Tissue Forceps



BD553R-BD563R

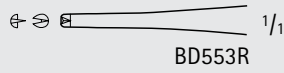

BD553R

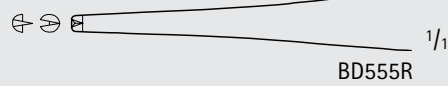

BD555R

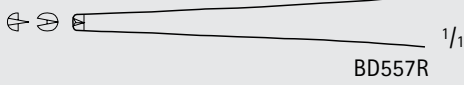

BD557R



BD559R

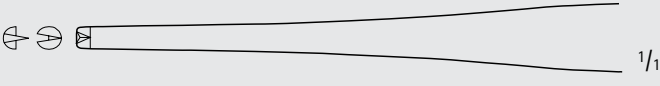

BD560R

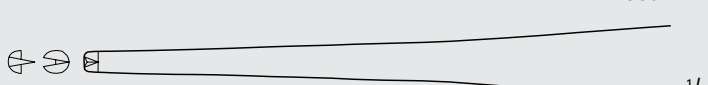

BD561R

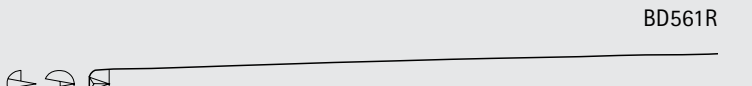

BD562R

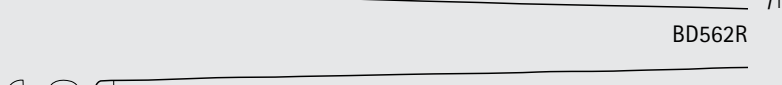

BD563R

Tissue Forceps, Standard Patterns

Catalog Number	Teeth	Length (in.)
BD553R	1 x 2	4 1/2
BD555R	1 x 2	5 1/8
BD557R	1 x 2	5 3/4
BD559R	1 x 2	6 1/4
BD560R	1 x 2	7
BD561R	1 x 2	7 7/8
BD562R	1 x 2	9 3/4
BD563R	1 x 2	11 3/4

# General Surgery

## Dressing and Tissue Forceps



BD690R-BD692R

### STRASSBURGER Tissue Forceps

Catalog Number	Tip	Teeth	Length (in.)
BD690R	X-SERR	1 x 2	6
BD692R	X-SERR	1 x 2	7 7/8



BD690R

1/1

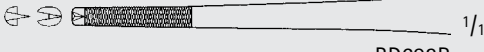

BD692R

1/1

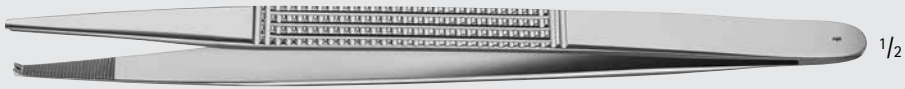

MG077R

### CURTIS Tissue Forceps

Catalog Number	Tip	Length (in.)
MG077R	SERR	8 3/4



MG077R

1/1



BD693R

### BONNEY Tissue Forceps

Catalog Number	Tip	Teeth	Length (in.)
BD693R	SERR	1 x 2	6 7/8
MG357R	SERR	2 x 3	6 3/4



BD693R

1/1



MG357R



MG357R

1/1



BD733R

### MARTIN Tissue Forceps

Catalog Number	Teeth	Length (in.)
BD733R	7 x 8	6 1/8

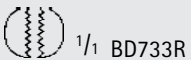

BD733R

1/1

# General Surgery

## Dressing and Tissue Forceps



MB224



MB224



MG464R-MG465R



MG464R



MG465R

### HEANEY Tissue Forceps

Catalog Number	Tip	Teeth	Length (in.)
MG464R	X-SERR	1 x 2	7 1/4
MB224	X-SERR	2 x 3	5 1/2
MG465R	X-SERR	3 x 4	7 1/2



BD725R-BD727R

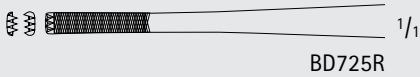

BD725R

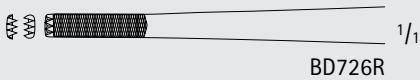

BD726R

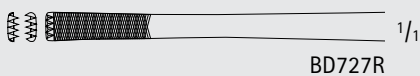

BD727R

### STILLE-BARRAYA CV Forceps

Catalog Number	Tip	Teeth	Length (in.)
BD725R	X-SERR	3 x 4	7
BD726R	X-SERR	3 x 4	7 7/8
BD727R	X-SERR	3 x 4	9 3/4



BD755R

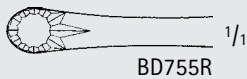

BD755R



BD760R-BD761R, MB921R-MB922R, XG006R

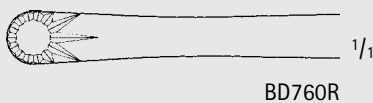

BD760R

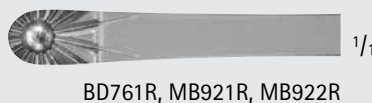

BD761R, MB921R, MB922R

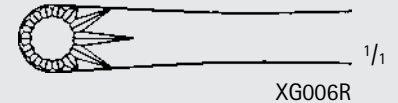

XG006R

### RUSSIAN Tissue Forceps

Catalog Number	Length (in.)
BD755R	6
BD760R	7 7/8
XG006R	9 3/4
BD761R	10 1/4
MB921R	12
MB922R	14



MB208R-MB923R



MAYO-RUSSIAN Tissue Forceps

Catalog Number	Tip	Length (in.)
MB208R	FENESTRATED	9
MB923R	FENESTRATED	14



BD750R

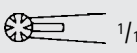

BD750R



MB795R



MB795R

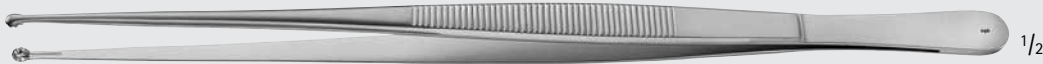

MG078R



MG078R

SELMAN Tissue Forceps

Catalog Number	Length (in.)
BD750R	6 1/8
MB795R	7 7/8
MG078R	9 3/4

# General Surgery

## Dressing and Tissue Forceps

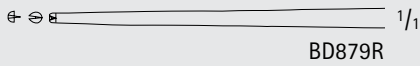
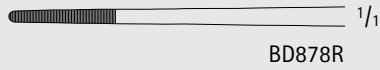

### LUCAE Bayonet Forceps

Catalog Number	Tip	Teeth	Length (in.)
BD878R	SERR	-	5 1/2
BD879R	SMOOTH	1 x 2	5 1/2

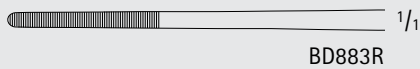

### GRUENWALD Bayonet Forceps

Catalog Number	Tip	Length (in.)
BD883R	SERR	7 7/8

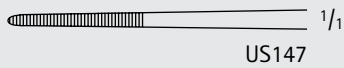

### CUSHING Bayonet Forceps

Catalog Number	Tip	Teeth	Length (in.)
US147	SERR	-	7 3/4
MB231	SMOOTH	1 x 2	7 1/4

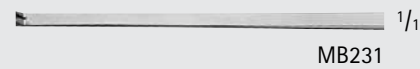

### BROWN-CUSHING Bayonet Forceps

Catalog Number	Teeth	Length (in.)
MB227	7 x 7	7 1/4

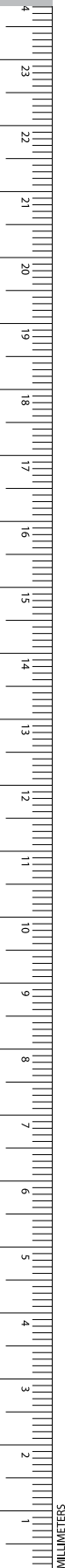

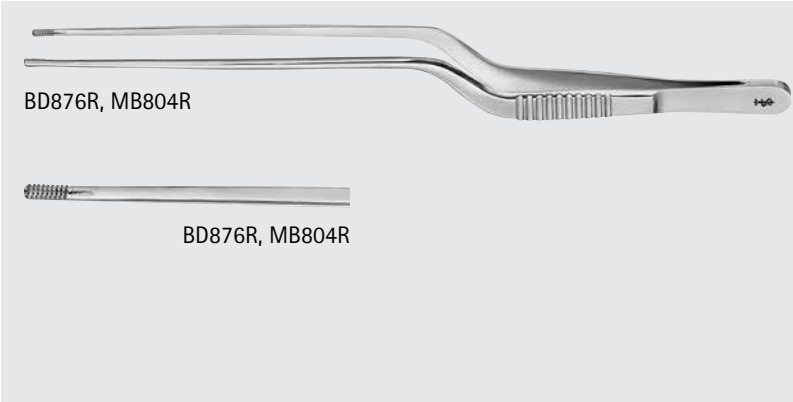

**BROWN-BAHNSON Bayonet Forceps**

Catalog Number	Tip	Length (in.)
BD876R	SERR	6 1/8
MB804R	SERR	8

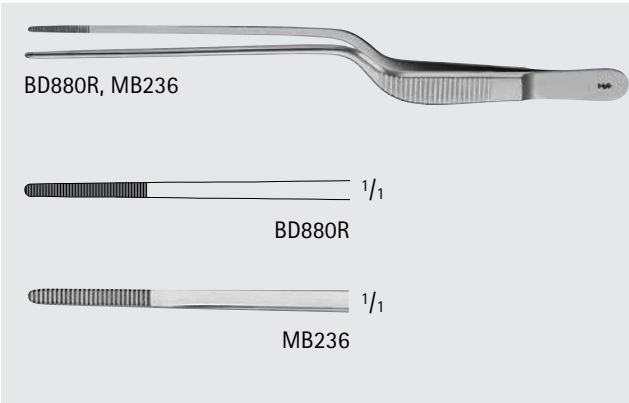

**JANSEN Bayonet Forceps**

Catalog Number	Tip	Length (in.)
BD880R	SERR	6 1/4
MB236	SERR	6 1/2

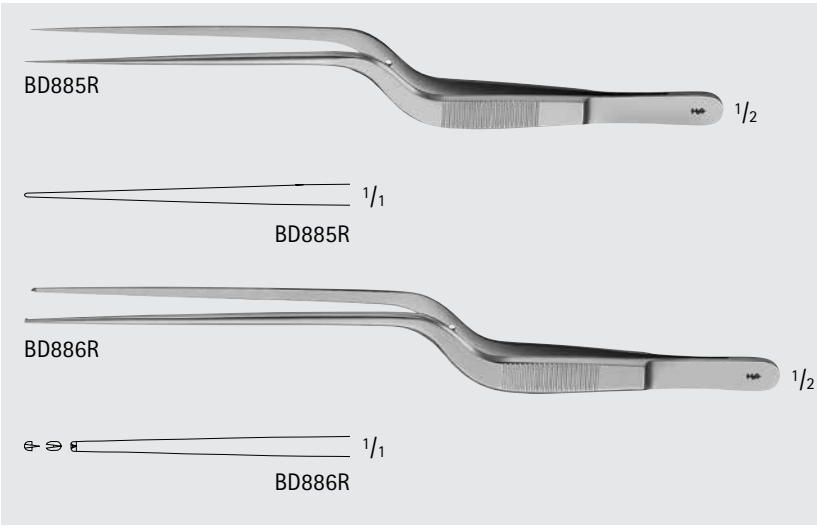

**Bayonet Forceps**

Catalog Number	Tip	Teeth	Length (in.)
BD885R	SMOOTH	-	7 1/4
BD886R	SMOOTH	1 x 2	7 7/8

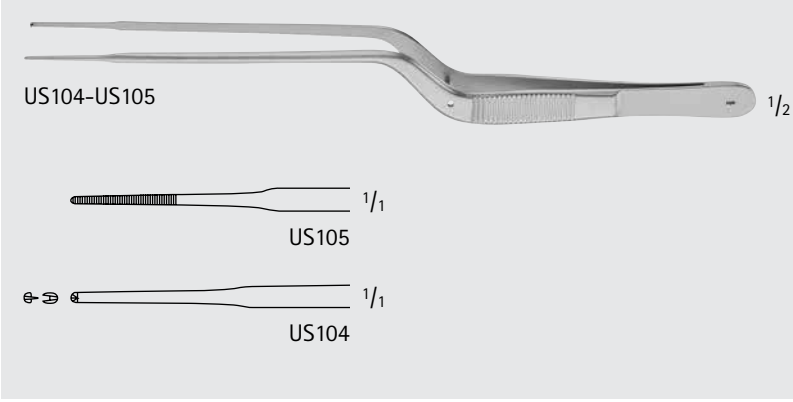

**GERALD Bayonet Forceps**

Catalog Number	Tip	Teeth	Length (in.)
US105	SERR	-	7 1/2
US104	SMOOTH	1 x 2	7 1/2

# General Surgery

## Dressing and Tissue Forceps

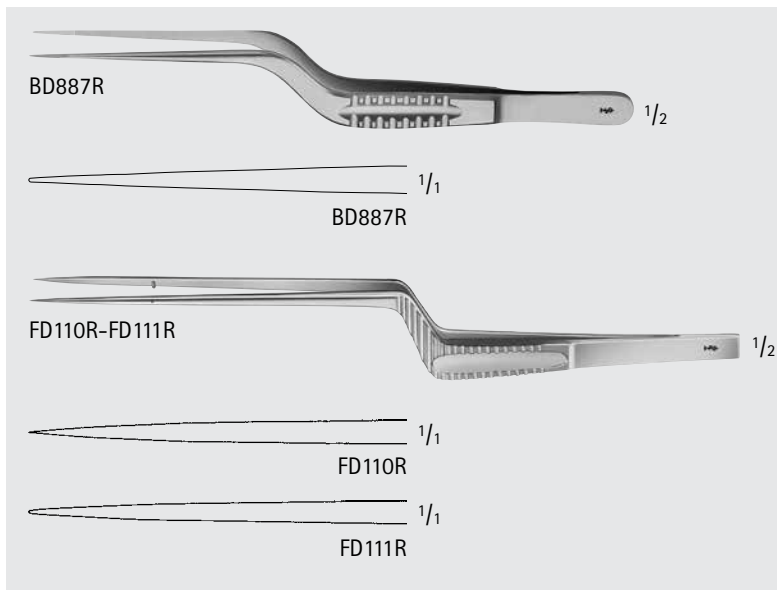

### Bayonet Forceps

Catalog Number	Tip	Length (in.)
BD887R		6 1/4
FD110R	FINE	7 1/4
FD111R	BROAD	7 1/4

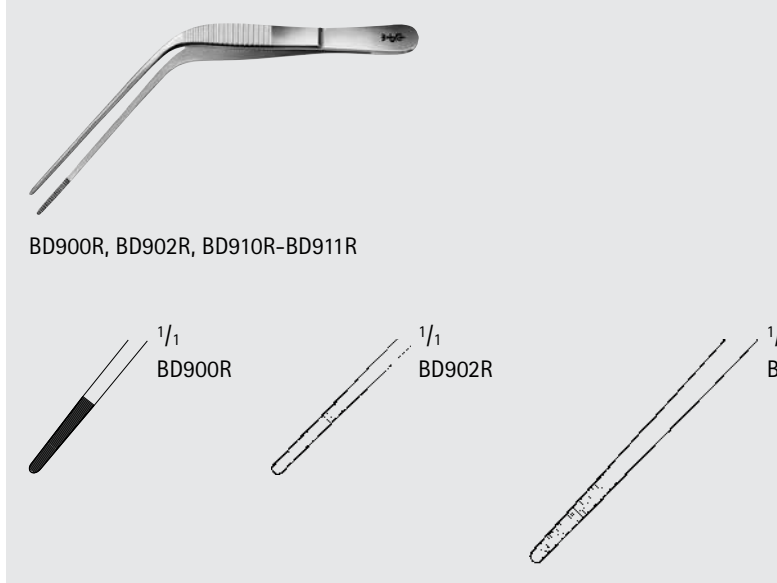

### TROELTSCH Bayonet Forceps

Catalog Number	Tip	Length (in.)
BD900R	ANG/SERR	4
BD902R	ANG/SERR	4 1/2
BD910R	ANG/SERR	5 1/2
BD911R	ANG/SERR	6 3/4

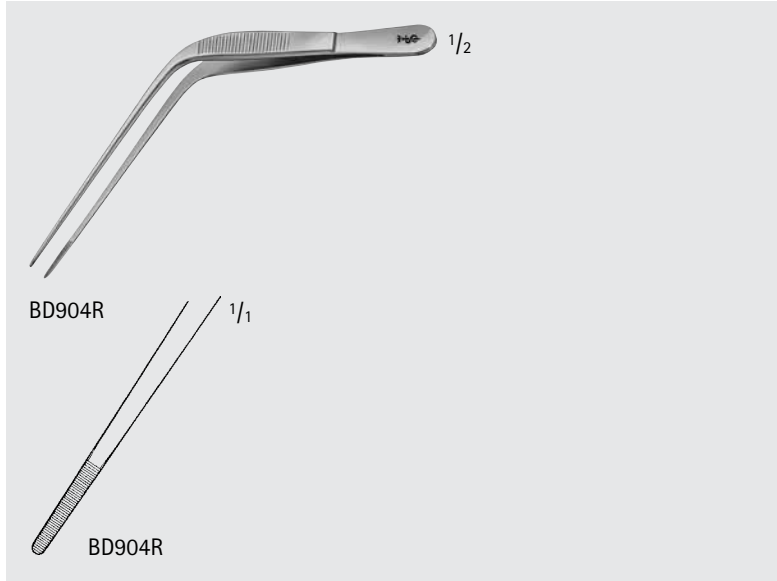

### WILDE Bayonet Forceps

Catalog Number	Tip	Length (in.)
BD904R	ANG/SERR	4 1/2

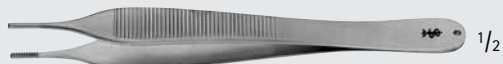

BD225R, MB291R



BD225R

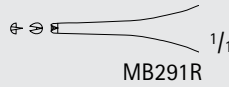

MB291R

**HUDSON Forceps**

Catalog Number	Tip	Teeth	Length (in.)
BD225R	SERR	-	5
MB291R	SMOOTH	1 x 2	5



BD610R-BD611R



BD610R



BD611R

**FERRIS-SMITH Tissue Forceps**

Catalog Number	Tip	Teeth	Length (in.)
BD610R	X-SERR	1 x 2	6 7/8
BD611R	X-SERR	2 x 3	6 7/8



BD215R-BD216R

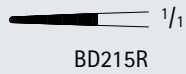

BD215R

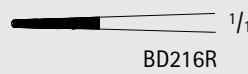

BD216R



BD665R-BD667R

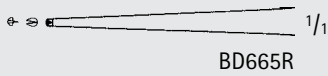

BD665R

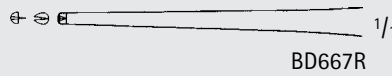

BD667R

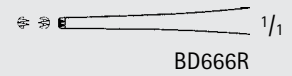

BD666R

**SEMKEN Forceps, Delicate**

Catalog Number	Tip	Teeth	Length (in.)
BD215R	SERR	-	5
BD216R	SERR	-	6
BD665R	SMOOTH	1 x 2	5
BD667R	SMOOTH	1 x 2	6
BD666R	SMOOTH	2 x 3	5



BD220R

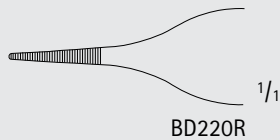

BD220R



BD223R



BD223R

**Micro ADSON Forceps, Delicate**

Catalog Number	Tip	Length (in.)
BD220R	SERR, W/ PLATFORM	4 3/4
BD223R	SERR	6



# General Surgery

## Dressing and Tissue Forceps

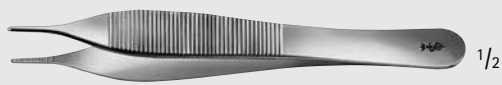

BD222R, MA156R

1/2



BD222R

MA156R

1/1

1/1



BD511R

1/2

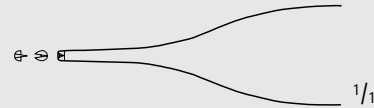

1/1



MG275R

1/2

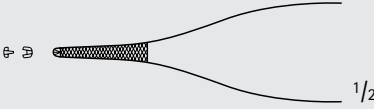

1/2



BD512R

1/2



1/1



MA536R

1/2



1/1

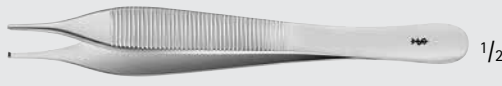

MB454R

1/2

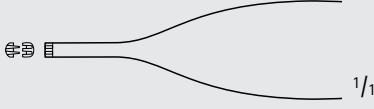

1/1

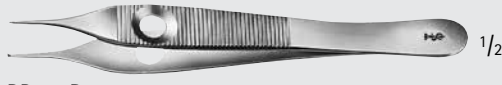

BD506R

1/2



1/1



BD507R

1/2



1/1



BD508R

1/2

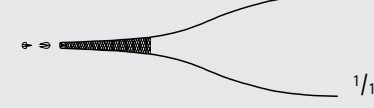

1/1



BD513R

1/2

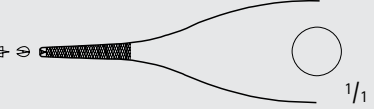

1/1

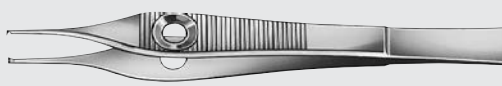

BD521R

1/2

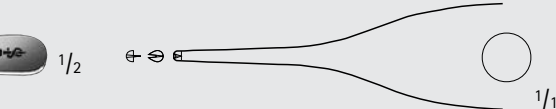

1/1

### ADSON Forceps, Delicate

Catalog Number	Tip	Teeth	Handle	Length (in.)
BD222R	SERR	-	-	4 3/4
MA156R	SERR, X-LONG	-	-	4 3/4
BD511R	SMOOTH	1 x 2	-	4 3/4
MG275R	SERR	1 x 2	-	4 3/4
BD512R	X-SERR W/ PLATFORM	1 x 2	-	4 3/4
MA536R	X-LONG	1 x 2	-	4 3/4
MB454R	SMOOTH	2 x 3	-	4 3/4
BD506R	SMOOTH	1 x 2	FENE-STRATED	4 3/4
BD507R	SMOOTH	1 x 2	FENE-STRATED	4 3/4
BD508R	SERR	1 x 2	FENE-STRATED	4 3/4
BD513R	X-SERR W/ PLATFORM	1 x 2	FENE-STRATED	4 3/4
BD521R	SMOOTH	1 x 2	FENE-STRATED	6



**MUSTARDE Suture Removal Forceps**

Catalog Number	Tip	Length (in.)
MG358R	LONGITUDINAL, SERR	5

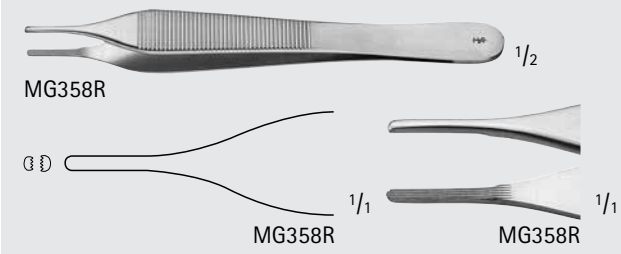

**CALLISON-ADSON Tissue Forceps, W/ Platform**

Catalog Number	Teeth	Length (in.)
MA537R	1 x 2	5

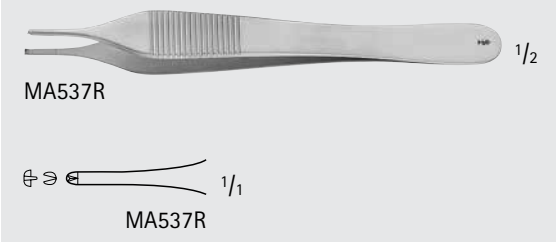

**ADSON-BROWN Tissue Forceps**

Catalog Number	Teeth	Length (in.)
BD700R	7 x 8	4 3/4

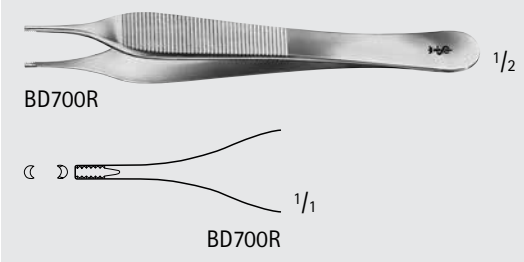

**BROWN Tissue Forceps**

Catalog Number	Teeth	Length (in.)
BD701R	7 x 8	6
BD702R	7 x 8	7 7/8

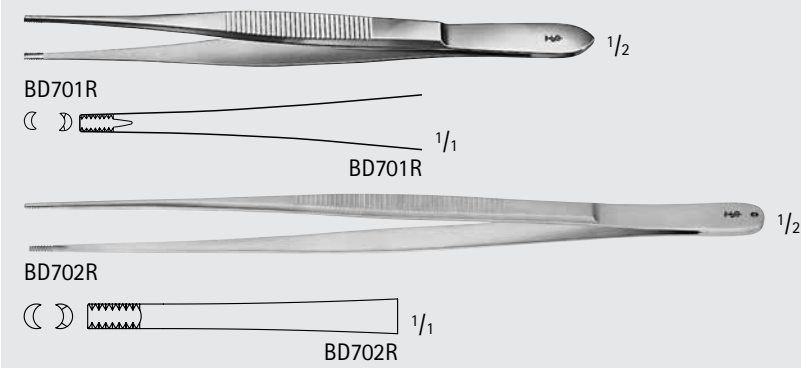

**MICRO ADSON Tissue Forceps, Delicate**

Catalog Number	Teeth	Length (in.)
BD510R	1 x 2	4 3/4
BD520R	1 x 2	6

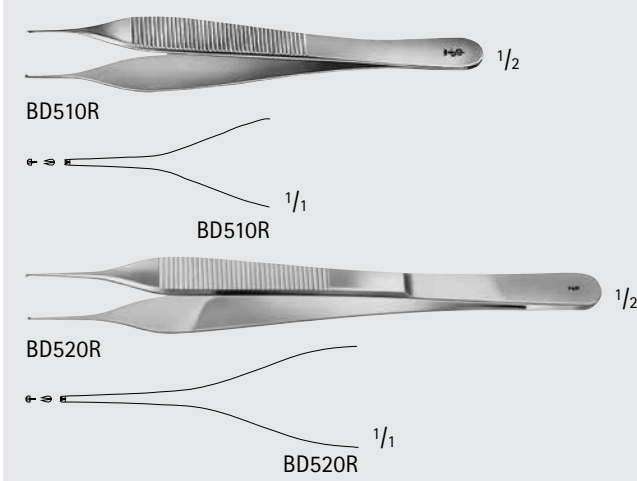

# General Surgery

## Dressing and Tissue Forceps



BD662R-BD664R

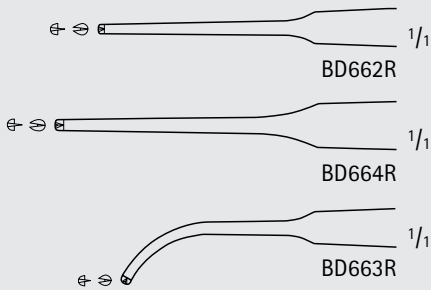

**GERALD Tissue Forceps, Delicate**

Catalog Number	Tip	Teeth	Length (in.)
BD662R	STR	1 x 2	6 7/8
BD664R	STR	1 x 2	9
BD663R	CVD	1 x 2	6 7/8

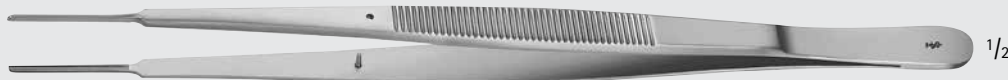

MG422R

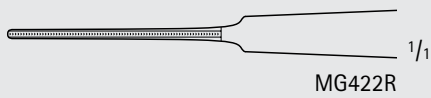

**GERALD-DEBAKEY Forceps, Narrow**

Catalog Number	Tip	Length (in.)
MG422R	SERR	9



BD522R

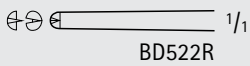

**ADSON Tissue Forceps, Delicate**

Catalog Number	Teeth	Length (in.)
BD522R	1 x 2	7



BD523R



**JEFFERSON Tissue Forceps, Delicate**

Catalog Number	Teeth	Length (in.)
BD523R	1 x 2	7



BD228R-BD230R

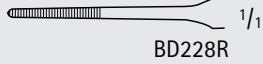

BD228R

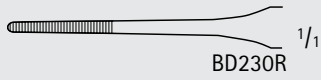

BD230R

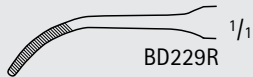

BD229R

**GERALD Dressing Forceps, Delicate**

Catalog Number	Tip	Length (in.)
BD228R	STR, SERR	6 7/8
BD230R	STR, SERR	9
BD229R	CVD, SERR	6 7/8



BD236R

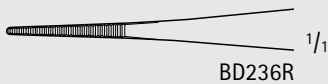

BD236R

**MCINDOE Thumb Forceps, Delicate**

Catalog Number	Tip	Length (in.)
BD236R	SERR	6



BD661R



BD661R

**MCINDOE Tissue Forceps, Delicate**

Catalog Number	Tip	Teeth	Length (in.)
BD661R	SERR	1 x 2	6



BD257R

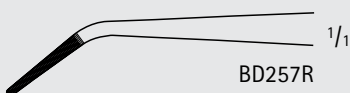

BD257R

**Delicate Forceps, Angled**

Catalog Number	Tip	Length (in.)
BD257R	SERR	7 7/8

# General Surgery

## Dressing and Tissue Forceps



BD238R-BD243R

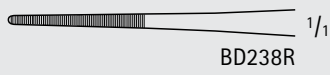

BD238R



BD239R

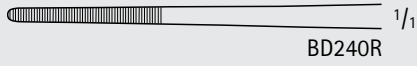

BD240R

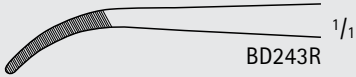

BD243R

### CUSHING Forceps, Delicate

Catalog Number	Tip	Length (in.)
BD238R	STR, SERR	7
BD239R	STR, SERR	7 7/8
BD240R	STR, SERR	9 3/4
BD243R	CVD, SERR	7 7/8



MD463

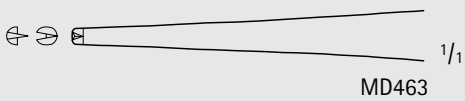

MD463

### CUSHING Tissue Forceps

Catalog Number	Teeth	Length (in.)
MD463	1 x 2	7



BD246R

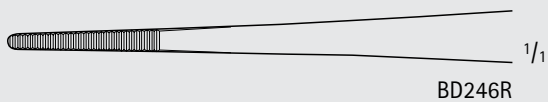

BD246R

### BROPHY Forceps, Delicate

Catalog Number	Tip	Length (in.)
BD246R	SERR	7 7/8

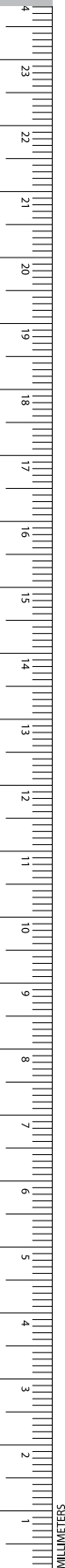

# General Surgery

## Dressing and Tissue Forceps



BD231R-BD232R

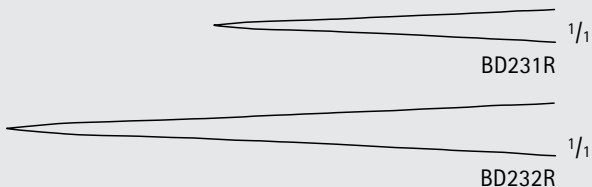

### Forceps, Delicate

Catalog Number	Tip	Length (in.)
BD231R	SMOOTH	7
BD232R	SMOOTH	7 7/8



BD301R-BD305R



### Micro Dressing Forceps

Catalog Number	Tip	Length (in.)
BD301R	STR, SERR	3 1/2
BD302R	STR, SERR	4 1/8
BD303R	STR, SERR	4 1/2
BD304R	STR, SERR	5 1/8
BD305R	STR, SERR	5 3/4
BD311R	CVD, SERR	3 1/2
BD312R	CVD, SERR	4 1/8
BD313R	CVD, SERR	4 1/2
BD314R	CVD, SERR	5 1/8
BD315R	CVD, SERR	5 3/4



BD311R-BD315R

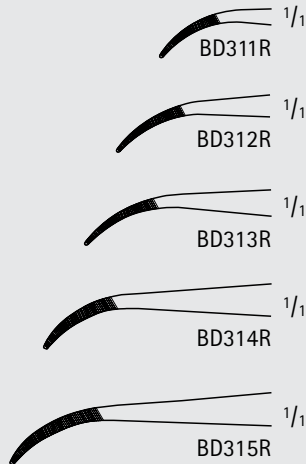

INCHES

# General Surgery

## Dressing and Tissue Forceps

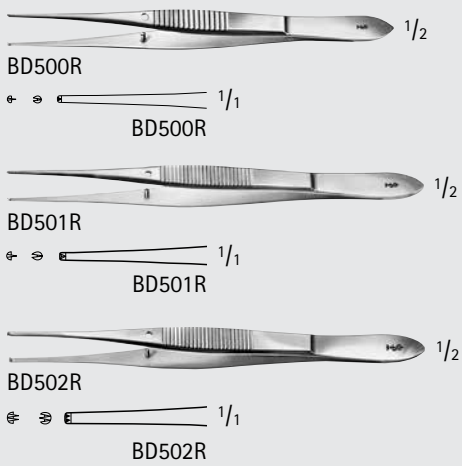

### Micro Tissue Forceps

Catalog Number	Teeth	Length (in.)
BD500R	1 x 2	4
BD501R	1 x 2	4 1/4
BD502R	2 x 3	4 1/4

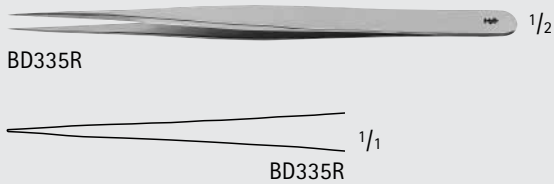

### Micro Forceps #3 Jewelers

Catalog Number	Tip Size (mm)	Length (in.)
BD335R	0.3	5 1/4

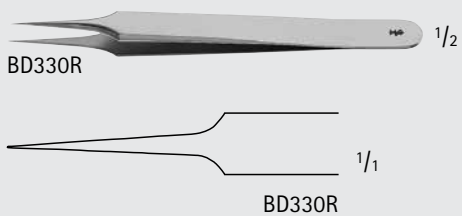

### Micro Forceps #4 Jewelers

Catalog Number	Tip Size (mm)	Length (in.)
BD330R	0.2	4 1/4

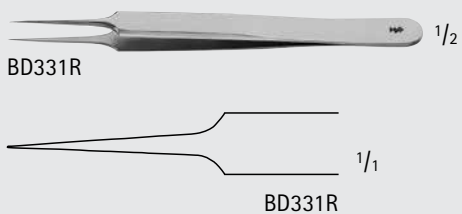

### Micro Forceps #5 Jewelers

Catalog Number	Tip Size (mm)	Length (in.)
BD331R	0.15	4 1/4

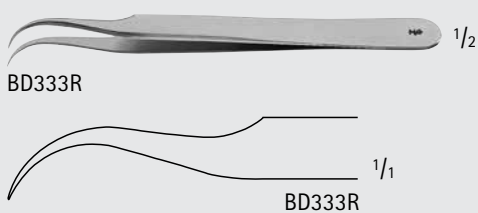

### Micro Forceps #7 Jewelers

Catalog Number	Tip Size (mm)	Length (in.)
BD333R	0.2	4 1/2

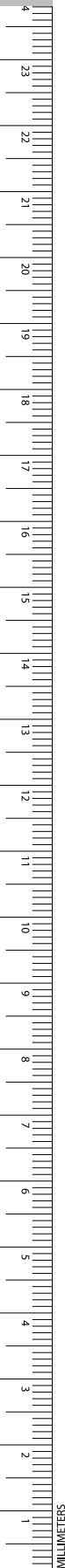



**GILLIES Tissue Forceps, Delicate**

Catalog Number	Tip	Teeth	Length (in.)
BD660R	X-SERR	1 x 2	6 1/8

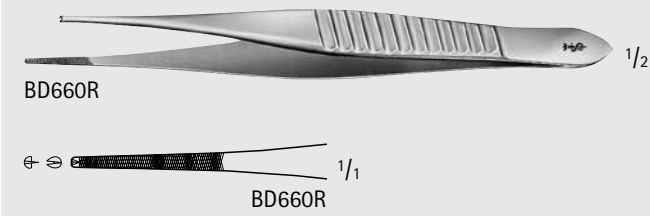

**SEMKEN Tissue Forceps, Delicate**

Catalog Number	Teeth	Length (in.)
BD669R	1 x 2	5 3/4

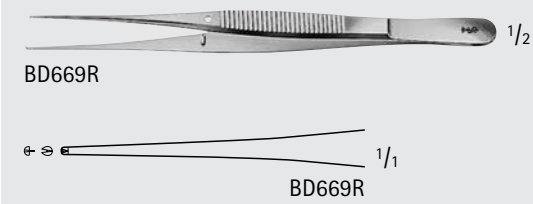

**WAUGH Tissue Forceps, Delicate**

Catalog Number	Tip	Teeth	Length (in.)
BD670R	X-SERR	1 x 2	7
BD671R	X-SERR	1 x 2	7 7/8
BD672R	X-SERR	1 x 2	9 3/4
BD679R	X-SERR	1 x 2	12

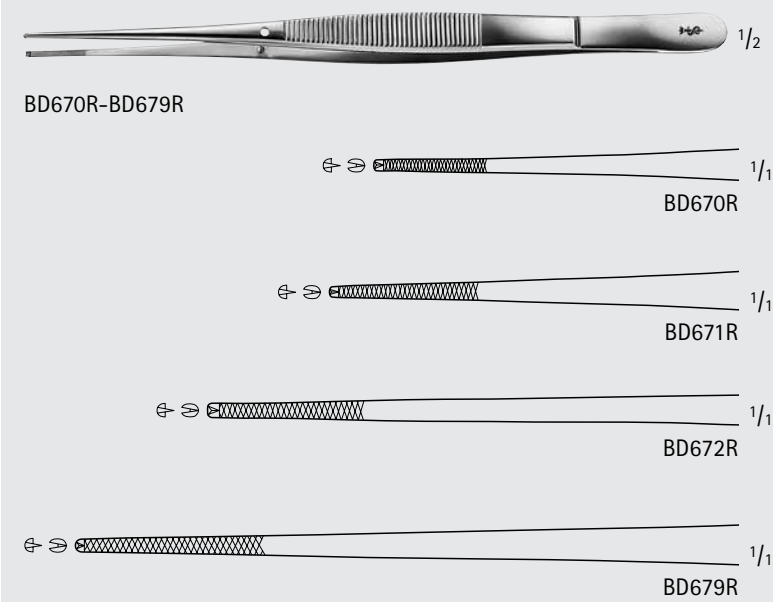

**DOCKTOR Forceps**

Catalog Number	Tip	Teeth	Length (in.)
MB211R	X-SERR	1 x 2	4 3/4

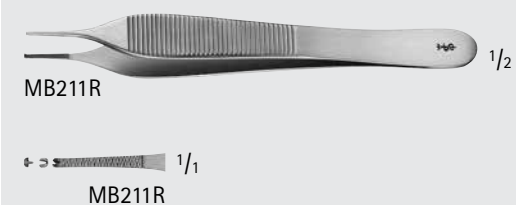

# General Surgery

## Dressing and Tissue Forceps

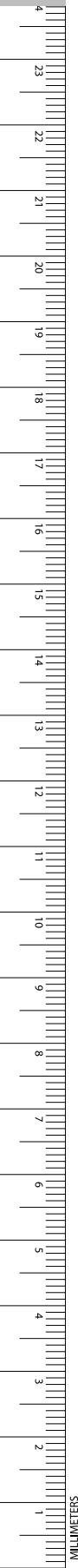

**DEBAKEY Atraumatic Ultra Light Forceps**

Catalog Number	Tip Size (mm)	Length (in.)
FC411R	1.2	6
FC412R	1.5	7 7/8
FC413R	1.5	9 1/2
FC418R	1.5	11 3/4

**DEBAKEY Atraumatic Vascular Tissue Forceps**

Catalog Number	Tip Size (mm)	Length (in.)
FB394R	1	6
FB395R	1	7 3/4
FB396R	1	9 1/2

**DEBAKEY Atraumatic Forceps**

Catalog Number	Tip Size (mm)	Length (in.)
FB411R	1.5	6
FB412R	1.5	7 7/8
FB418R	1.5	9 1/2
FB419R	1.5	11 3/4

DEBAKEY Atraumatic Forceps

Catalog Number	Tip Size (mm)	Length (in.)
FB400R	2	6
FB402R	2	7 7/8
FB404R	2	9 1/2
FB405R	2	11 3/4
FB414R	2.8	6
FB415R	2.8	7 7/8
FB416R	2.8	9 1/2
FB417R	2.8	11 3/4
FB406R	3.5	7 7/8
FB407R	3.5	9 1/2
FB408R	3.5	11 3/4
FB409R	3.5	13 3/4

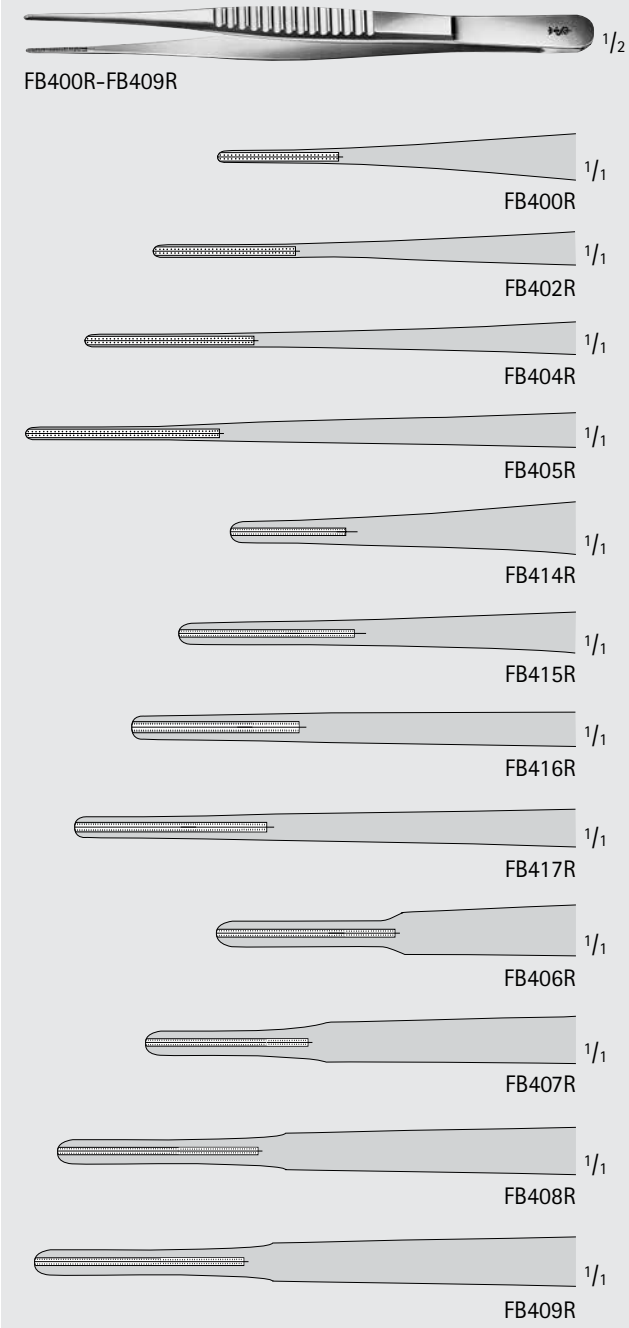

INCHES

# General Surgery

## Dressing and Tissue Forceps



FB401R-FB410R

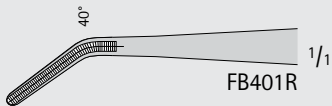

FB401R

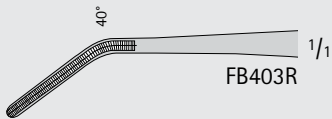

FB403R

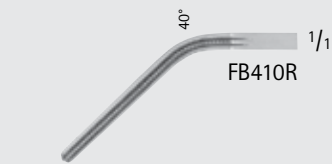

FB410R

### DEBAKEY Atraumatic Forceps, Angled

Catalog Number	Tip Size (mm)	Length (in.)
FB401R	2	6
FB403R	2	7 7/8
FB410R	2	9 1/2



FB784R



FB784R



FB785R



FB785R

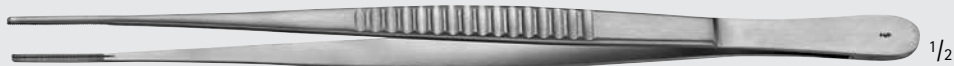

FB786R



FB786R

### COOLEY Atraumatic Vascular Tissue Forceps

Catalog Number	Tip Size (mm)	Length (in.)
FB784R	1.5	6
FB785R	2.0	7 3/4
FB786R	2.3	9 1/2

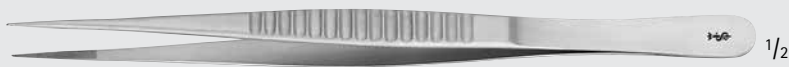

BD250R



BD250R

### COOLEY Vascular Tissue Forceps

Catalog Number	Length (in.)
BD250R	7 7/8

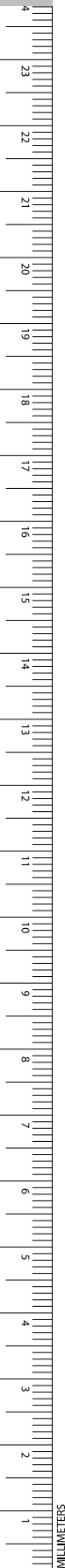



BD770R

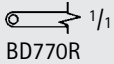

BD770R

**MILLS Mammary/Coronary Tissue Forceps**

Catalog Number	Length (in.)
BD770R	7



FB130R

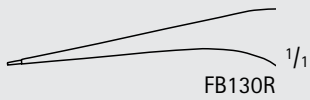

FB130R

**Dilator Forceps**

Catalog Number	Tip Size (mm)	Length (in.)
FB130R	0.2	4 1/2



BD980R

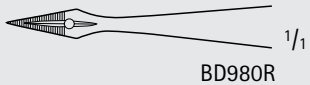

BD980R

**HUNTER Splinter Forceps**

Catalog Number	Length (in.)
BD980R	4 1/8

# General Surgery

## DUROGRIP™ TC Tissue Forceps

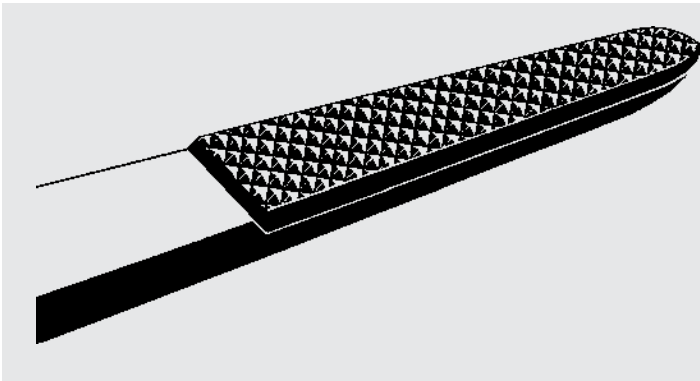

DUROGRIP Tungsten Carbide Tissue Forceps

- Cross-Serrated Platform tips for firm and non-traumatic grip
- Long working life
- Gold-plated end



BD151R

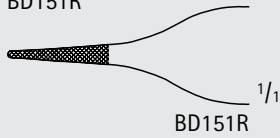

BD151R



US109-US110

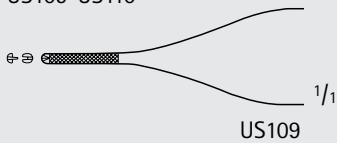

US109

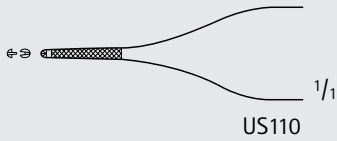

US110



MB484R-MB485R



MB484R



MB485R

### DUROGRIP TC ADSON Forceps

Catalog Number	Tip	Teeth	Length (in.)
BD151R	X-SERR	-	4 3/4
US109	X-SERR	1 x 2	4 3/4
US110	DEL, X-SERR	1 x 2	4 3/4
MB484R	X-SERR	1 x 2	6
MB485R	DEL, X-SERR	1 x 2	6



US112

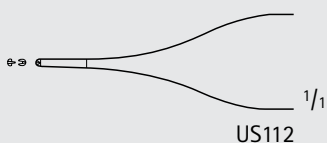

US112

### DUROGRIP TC GORNEY-ADSON Forceps

Catalog Number	Tip	Teeth	Length (in.)
US112	DEL, SMOOTH	1 x 2	4 3/4

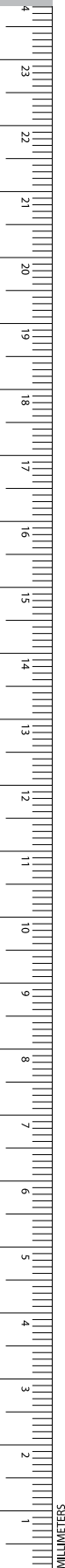

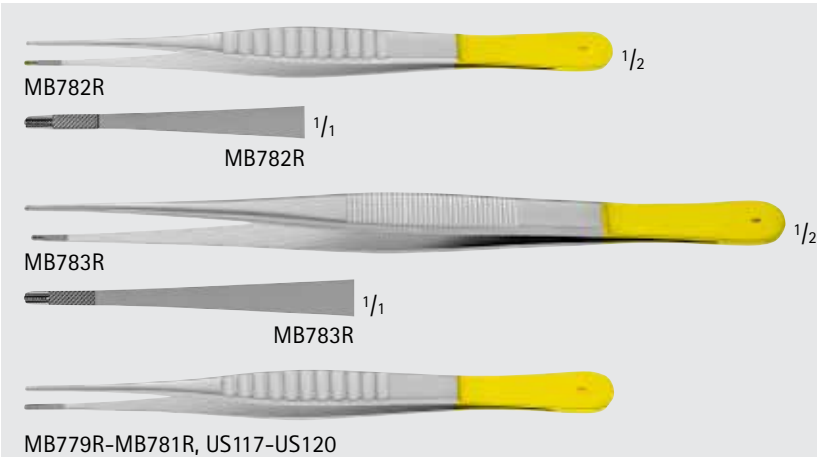

DUROGRIP TC DEBAKEY Needle Forceps

Catalog Number	Tip	Tip Size (mm)	Length (in.)
MB782R	-	1.5	6
MB783R	-	1.5	7 3/4
US119	NARROW	1.5	7 3/4
MB779R	-	2	6
MB780R	-	2	8
MB781R	-	2	10 1/2
US117	-	2	6
US118	-	2	8
US120	NARROW	2	9

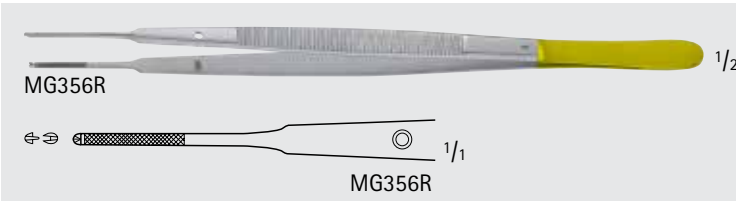
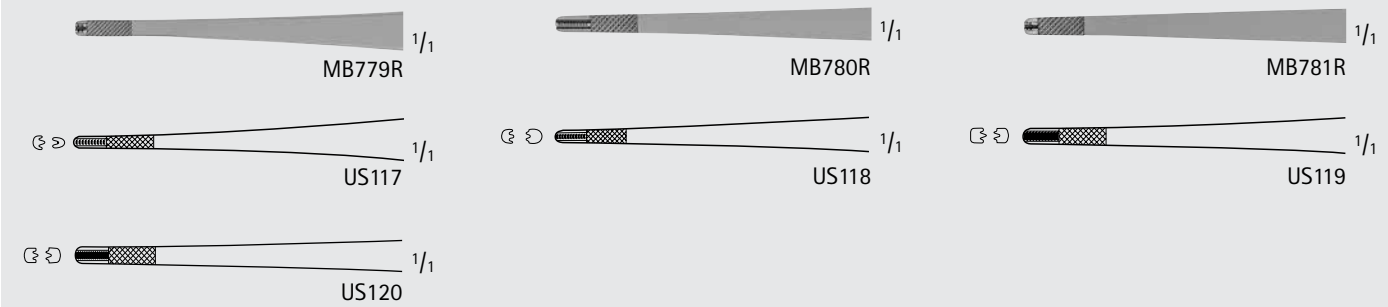

GERALD Needle Forceps

Catalog Number	Tip	Teeth	Length (in.)
MG356R	X-SERR	1 x 2	6 7/8

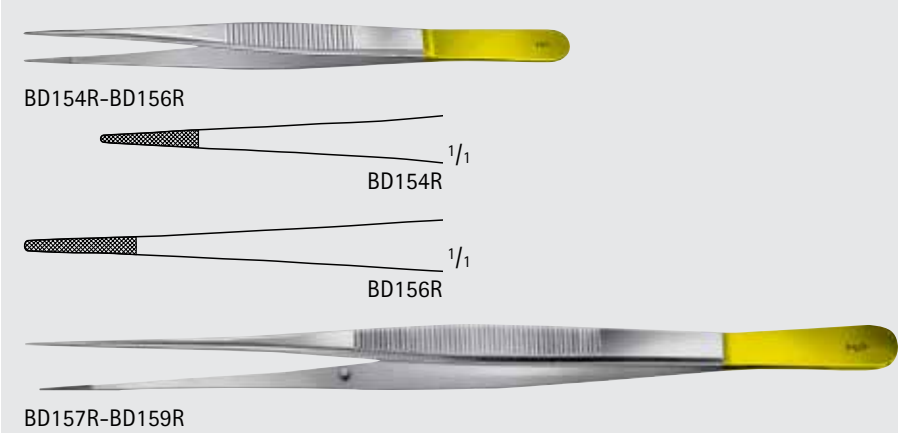

DUROGRIP TC (POTTS-SMITH) Thumb Forceps

Catalog Number	Tip	Length (in.)
BD154R	X-SERR	5 3/4
BD156R	X-SERR	7
BD157R	X-SERR	7 7/8
BD158R	X-SERR	9
BD159R	X-SERR	9 3/4

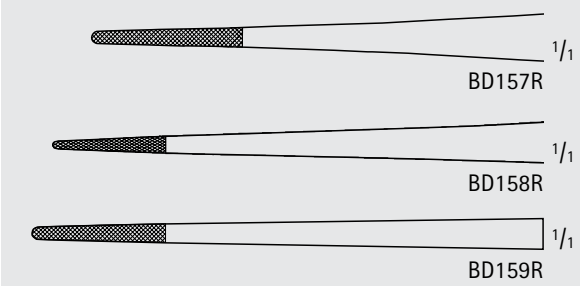

INCHES

# General Surgery

## DUROGRIP™ TC Tissue Forceps

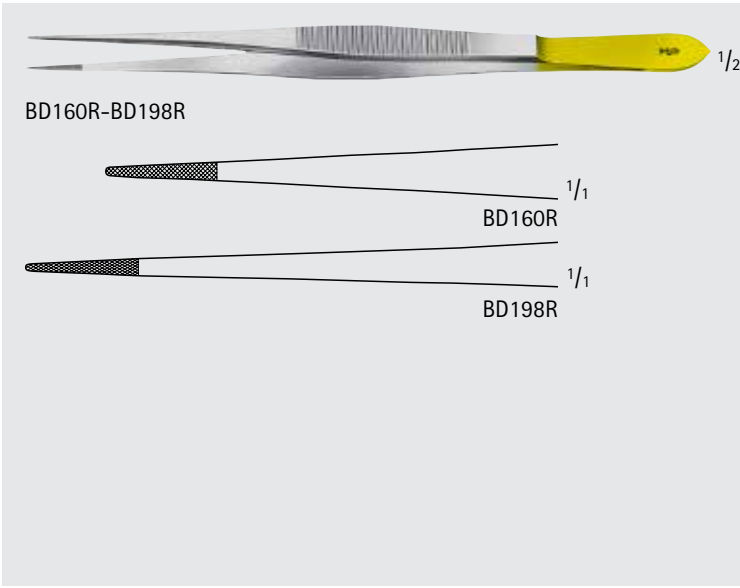

**DUROGRIP TC CUSHING Forceps, W/ Scraper End**

Catalog Number	Tip	Length (in.)
BD160R	X-SERR	7
BD198R	X-SERR	9 3/4

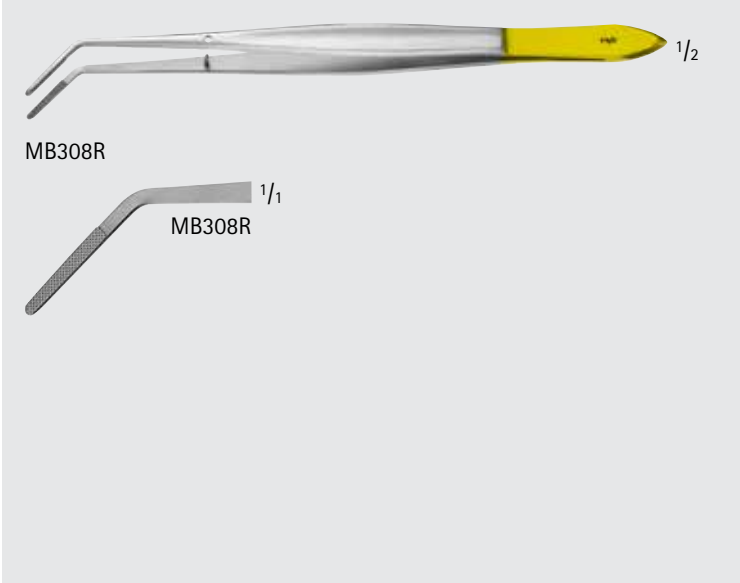

**DUROGRIP TC CUSHING Forceps**

Catalog Number	Tip	Length (in.)
MB308R	ANG, X-SERR	6 1/4

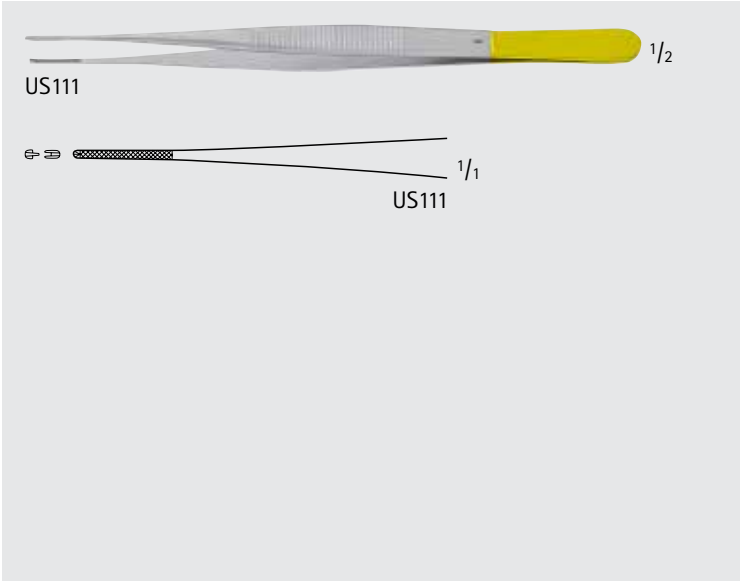

**DUROGRIP TC SEMKEN Forceps**

Catalog Number	Tip	Tip Size (mm)	Teeth	Length (in.)
US111	X-SERR	1	1 x 2	6 1/4



BD164R-BD166R

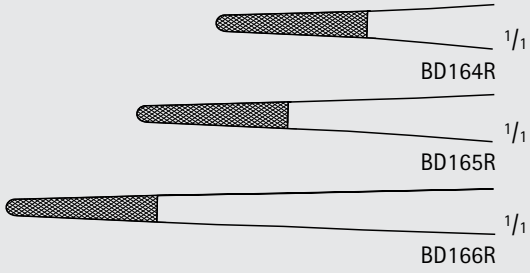

DUROGRIP TC STANDARD Forceps

Catalog Number	Tip	Length (in.)
BD164R	X-SERR	5 3/4
BD165R	X-SERR	7 7/8
BD166R	X-SERR	9 3/4



BD168R

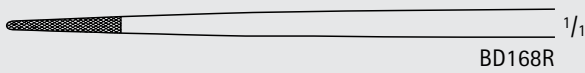

DUROGRIP TC GRUENWALD Forceps

Catalog Number	Tip	Length (in.)
BD168R	X-SERR	7 1/4



BD171R-BD173R

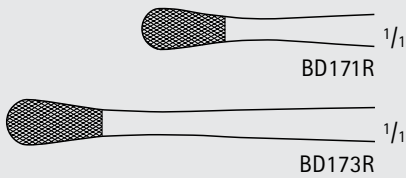

DUROGRIP TC WANGENSTEEN Forceps

Catalog Number	Tip	Length (in.)
BD171R	X-SERR	6
BD173R	X-SERR	9



INCHES

# General Surgery

## Abdominal and Intestinal Grasping Forceps

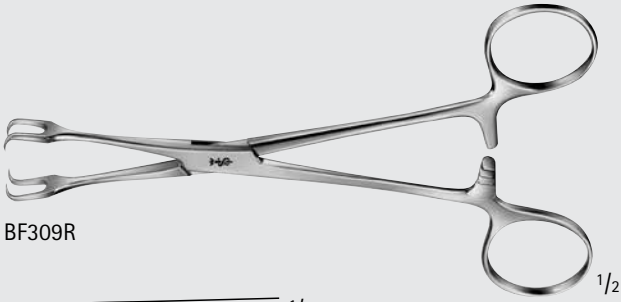
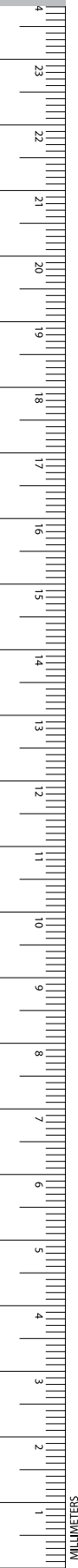

BF309R

1/2

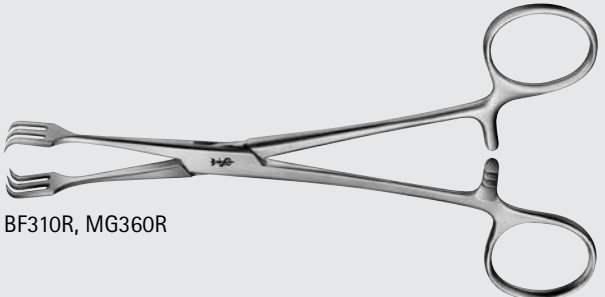
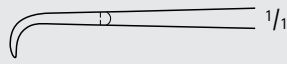

BF310R, MG360R

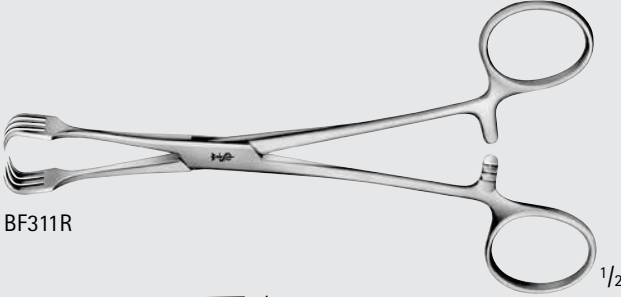
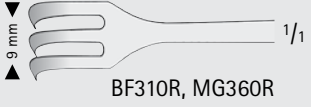
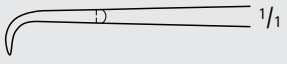

BF311R

1/2

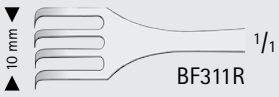
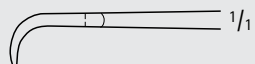

### LAHEY Forceps

Catalog Number	Teeth	Length (in.)
BF309R	2 x 2	6 1/8
BF310R	3 x 3	6 1/8
MG360R	3 x 3	8
BF311R	4 x 4	6 1/8

# General Surgery

## Abdominal and Intestinal Grasping Forceps



### BOYS-ALLIS Forceps

Catalog Number	Teeth	Length (in.)
EA010R	5 x 6	6 1/8

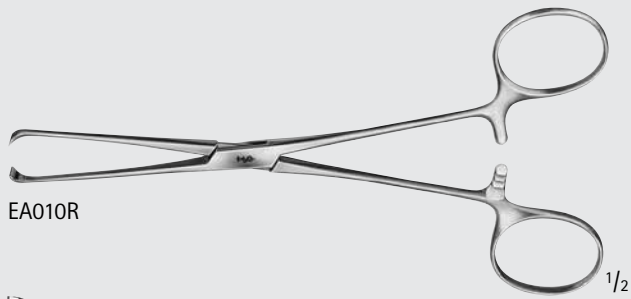

EA010R

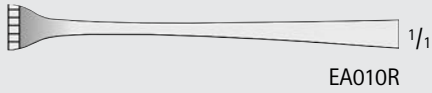

EA010R

### Baby ALLIS Forceps

Catalog Number	Teeth	Length (in.)
EA012R	4 x 5	5 1/8

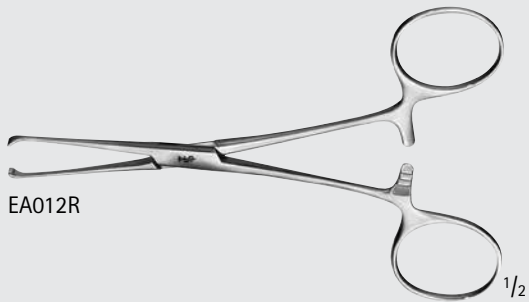

EA012R

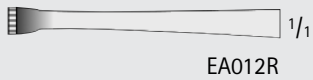

EA012R

### ALLIS Forceps

Catalog Number	Teeth	Length (in.)
EA015R	4 x 5	6 1/8
EA016R	5 x 6	6 1/8
EA017R	5 x 6	7 1/2
FB938R	5 x 6	8 3/4
EA018R	5 x 6	10
MB910R	5 x 6	16

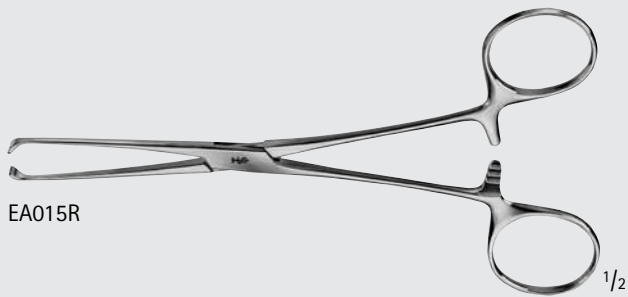

EA015R



EA015R

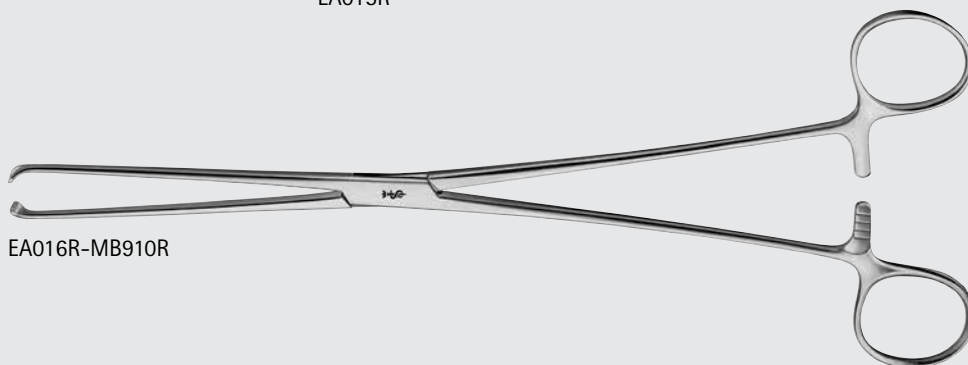

EA016R-MB910R



EA016R-MB910R

# General Surgery

## Abdominal and Intestinal Grasping Forceps

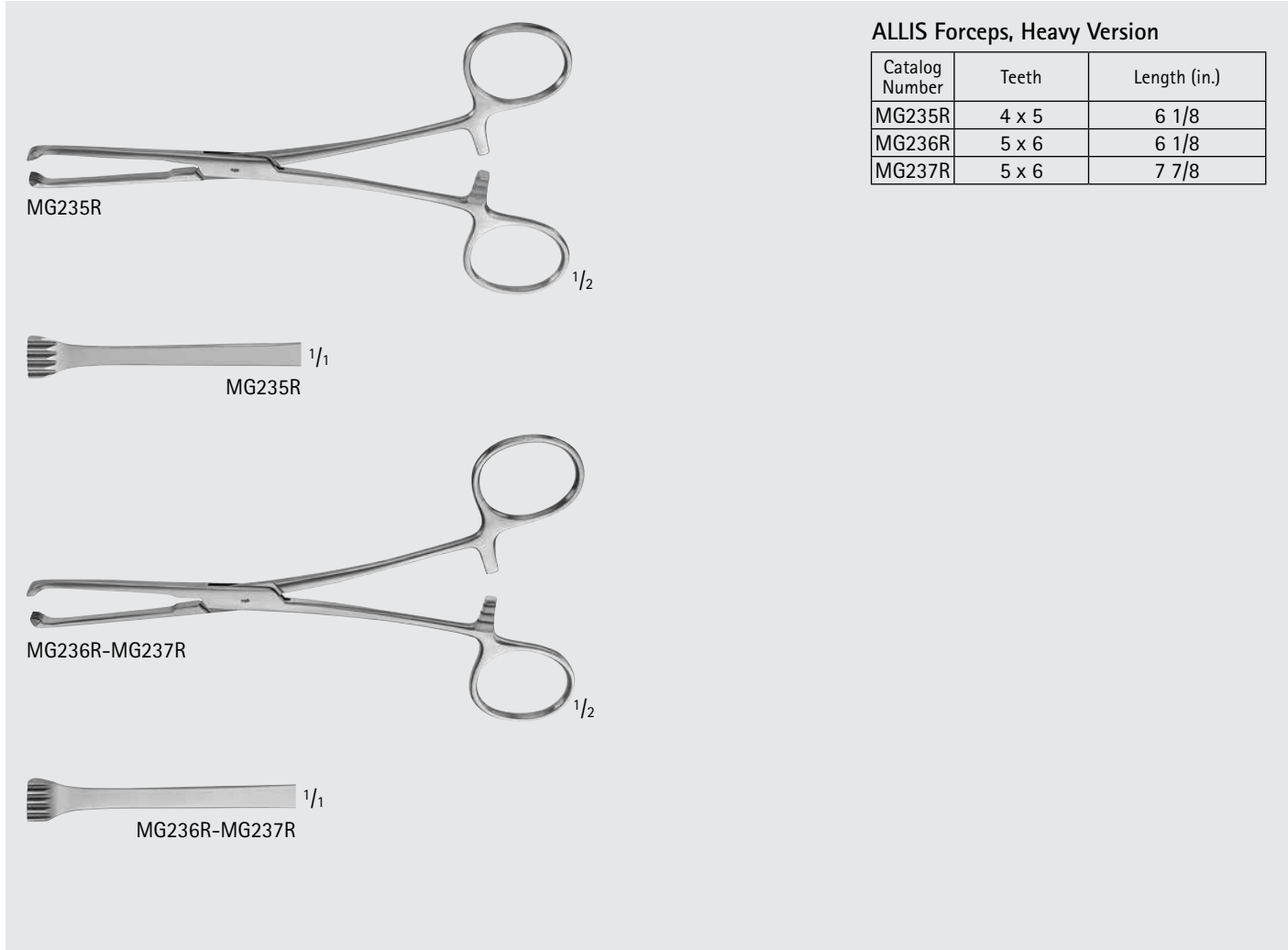
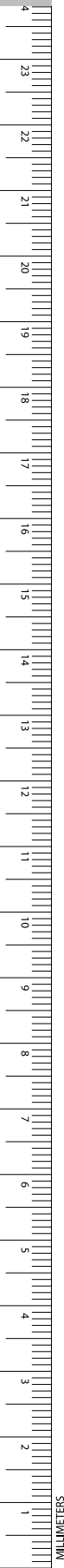

**ALLIS Forceps, Heavy Version**

Catalog Number	Teeth	Length (in.)
MG235R	4 x 5	6 1/8
MG236R	5 x 6	6 1/8
MG237R	5 x 6	7 7/8

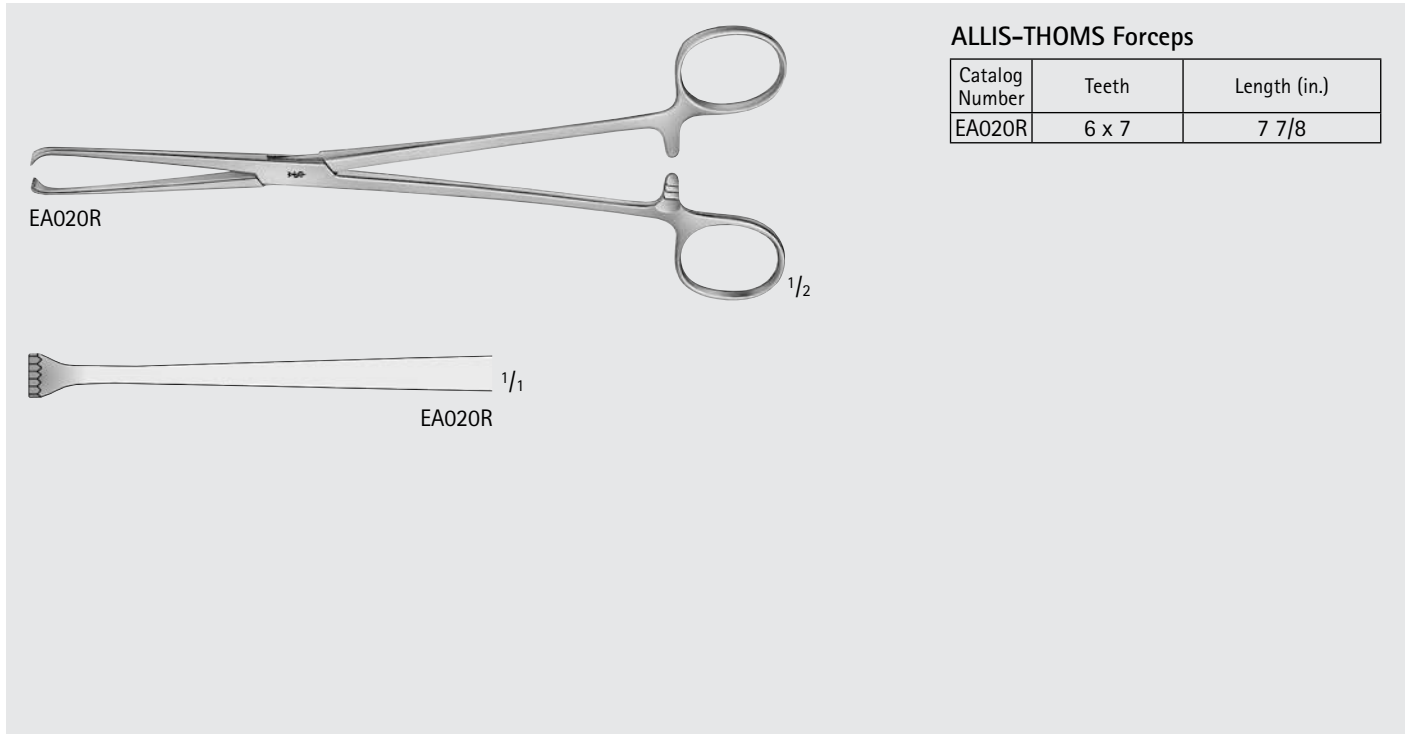

**ALLIS-THOMS Forceps**

Catalog Number	Teeth	Length (in.)
EA020R	6 x 7	7 7/8

# General Surgery

## Abdominal and Intestinal Grasping Forceps



### JUDD-ALLIS Forceps

Catalog Number	Teeth	Length (in.)
EA025R	3 x 4	6 1/8
EA026R	3 x 4	7 7/8

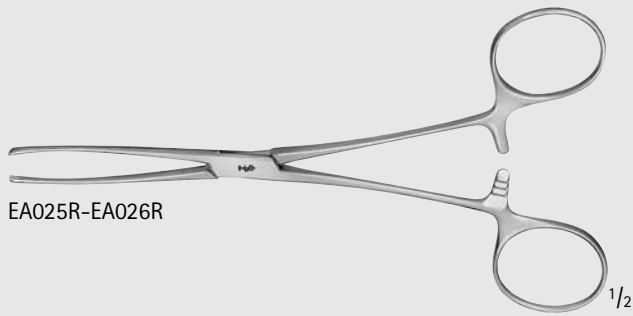

EA025R-EA026R

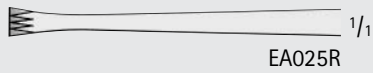

EA025R

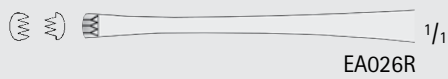

EA026R

### ALLIS-ADAIR Clamp

Catalog Number	Teeth	Length (in.)
MD568	9 x 10	6 1/4

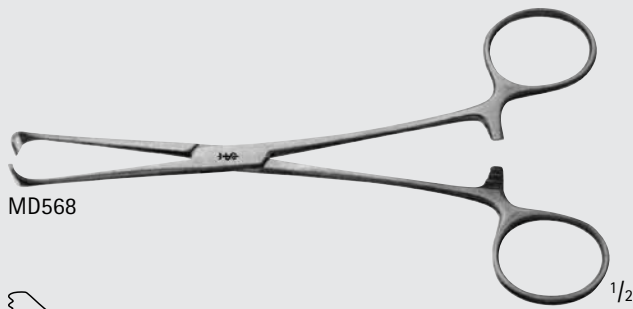

MD568

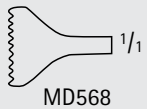

MD568

### LOCKWOOD-ALLIS Intestinal Clamp

Catalog Number	Teeth	Length (in.)
MG455R	4 x 5	6 1/2

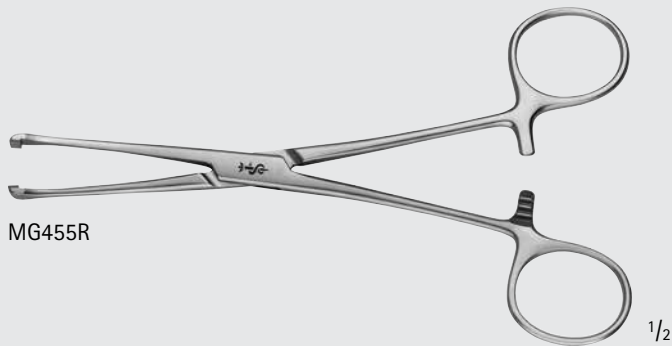

MG455R



MG455R

# General Surgery

## Abdominal and Intestinal Grasping Forceps

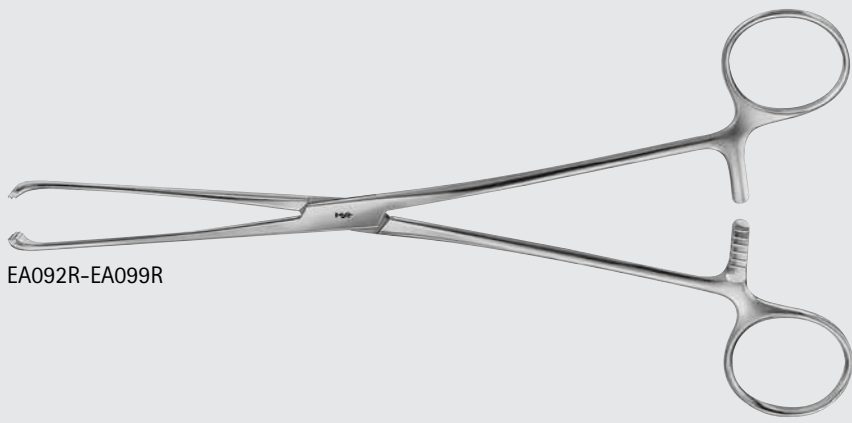
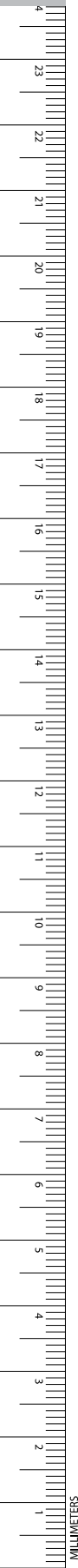

EA092R-EA099R

### ALLIS Atraumatic Forceps

Catalog Number	Length (in.)
EA092R	6 1/4
EA095R	7 7/8
EA096R	8 3/4
EA097R	10
EA100R	11 5/8
EA099R	11 3/4
EA101R	14

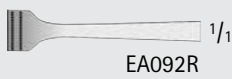

EA092R

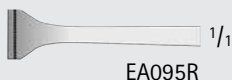

EA095R

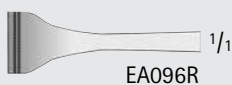

EA096R

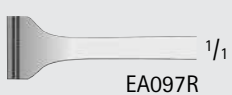

EA097R

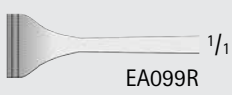

EA099R

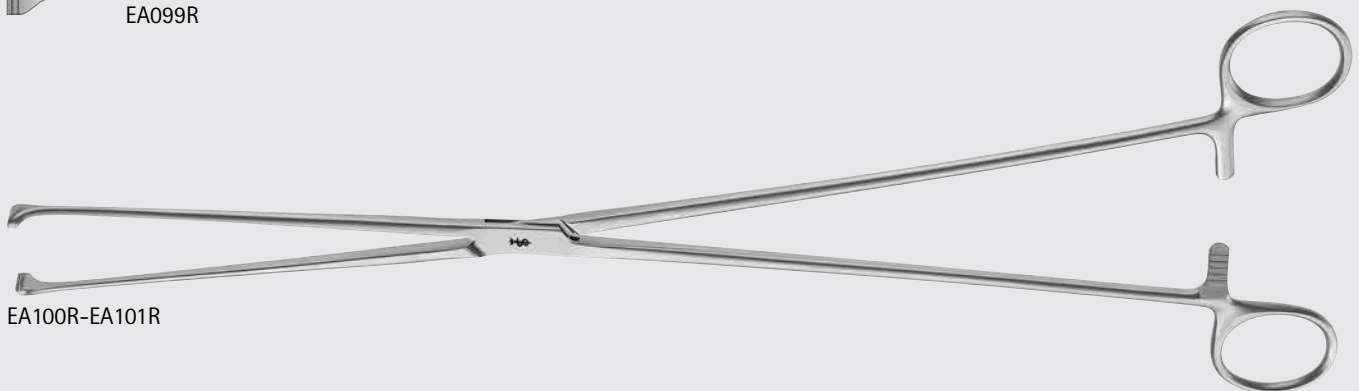

EA100R-EA101R

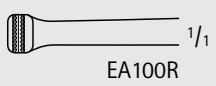

EA100R

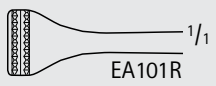

EA101R

# General Surgery

## Abdominal and Intestinal Grasping Forceps

GENERAL SURGERY



### GLASSMAN-ALLIS Common Duct Forceps Non-Crushing

Catalog Number	Length (in.)
MG435R	8 1/2

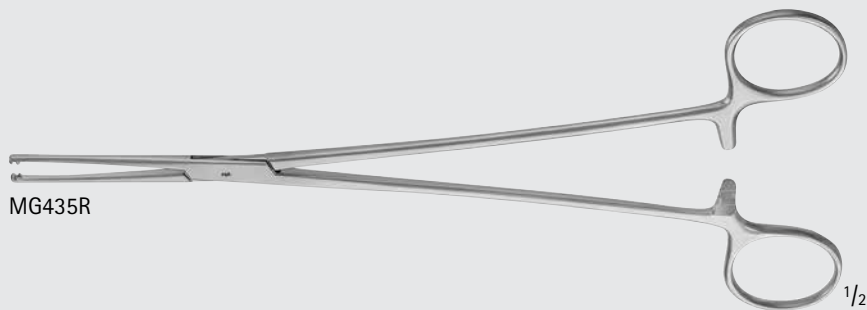

MG435R

1/2



MG435R

### BABCOCK Tissue Holding Forceps

Catalog Number	Length (in.)
MB136R	12
MB137R	14

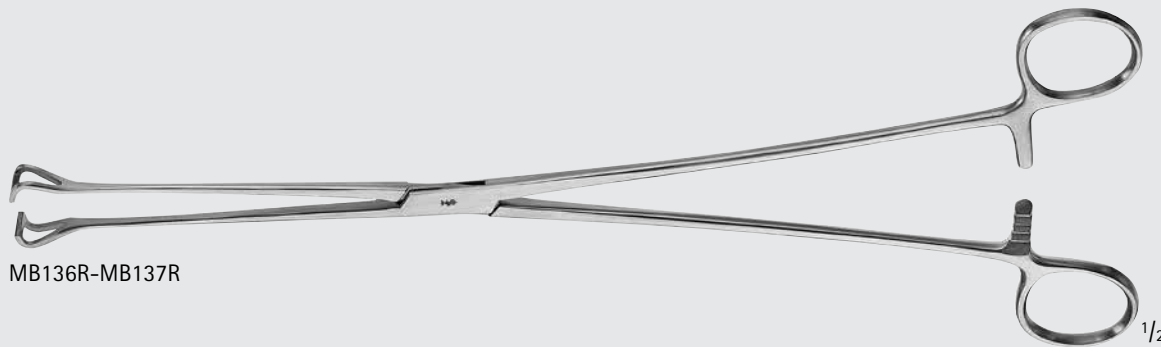

MB136R-MB137R

1/2



MB136R

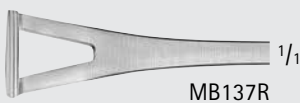

MB137R

INCHES

# General Surgery

## Abdominal and Intestinal Grasping Forceps



EA030R-MG359R



MG359R

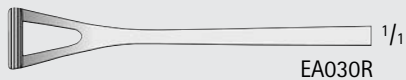

EA030R



EA031R



EA032R

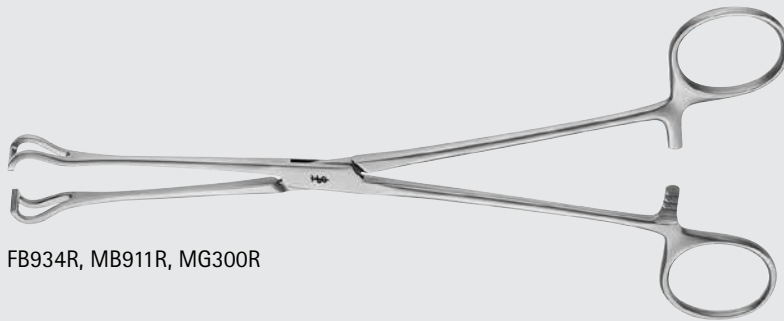

FB934R, MB911R, MG300R

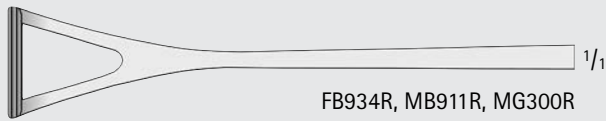

FB934R, MB911R, MG300R



MB911R

### BABCOCK Forceps

Catalog Number	Tip	Length (in.)
MG359R	-	5 1/2
EA030R	-	6 1/8
EA031R	-	6 7/8
EA032R	-	8 1/2
FB934R	-	8 3/4
MB300R	-	14
MB911R	DEL, PETITE	16

# General Surgery

## Abdominal and Intestinal Grasping Forceps

### BABCOCK Atraumatic Forceps

Catalog Number	Length (in.)
EA050R	6 1/4
EA052R	8 1/2
FB936R	8 3/4
MD470	9 1/2

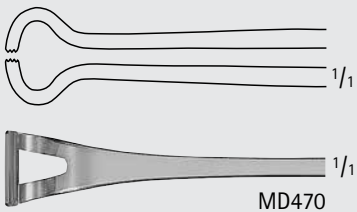
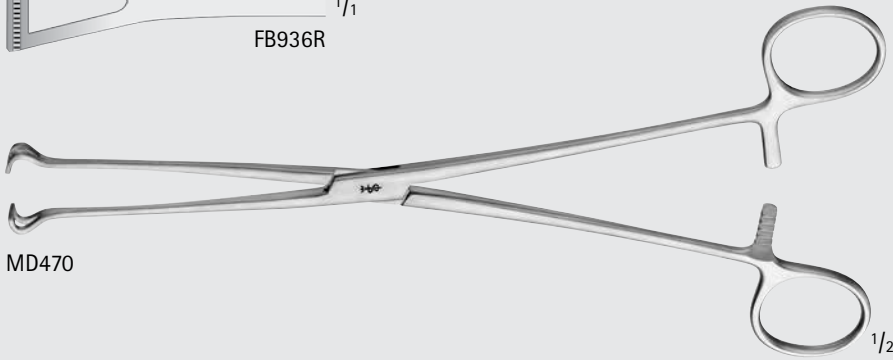
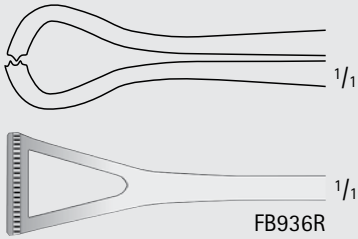
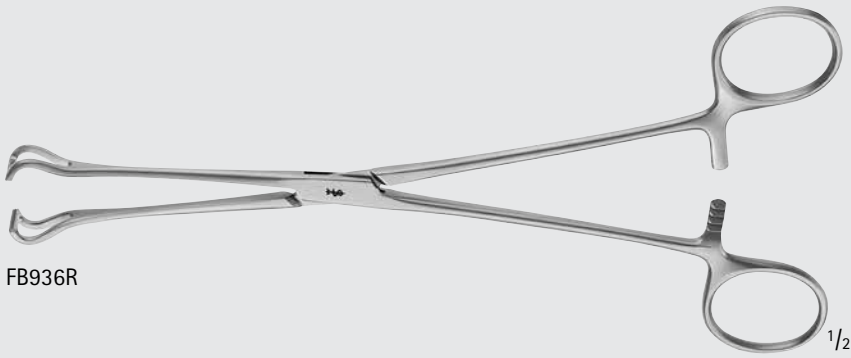
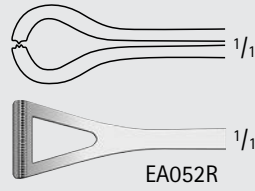
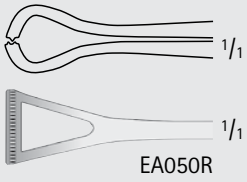
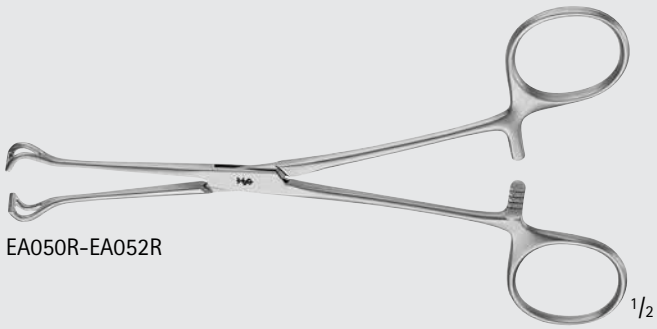

# General Surgery

## Abdominal and Intestinal Grasping Forceps

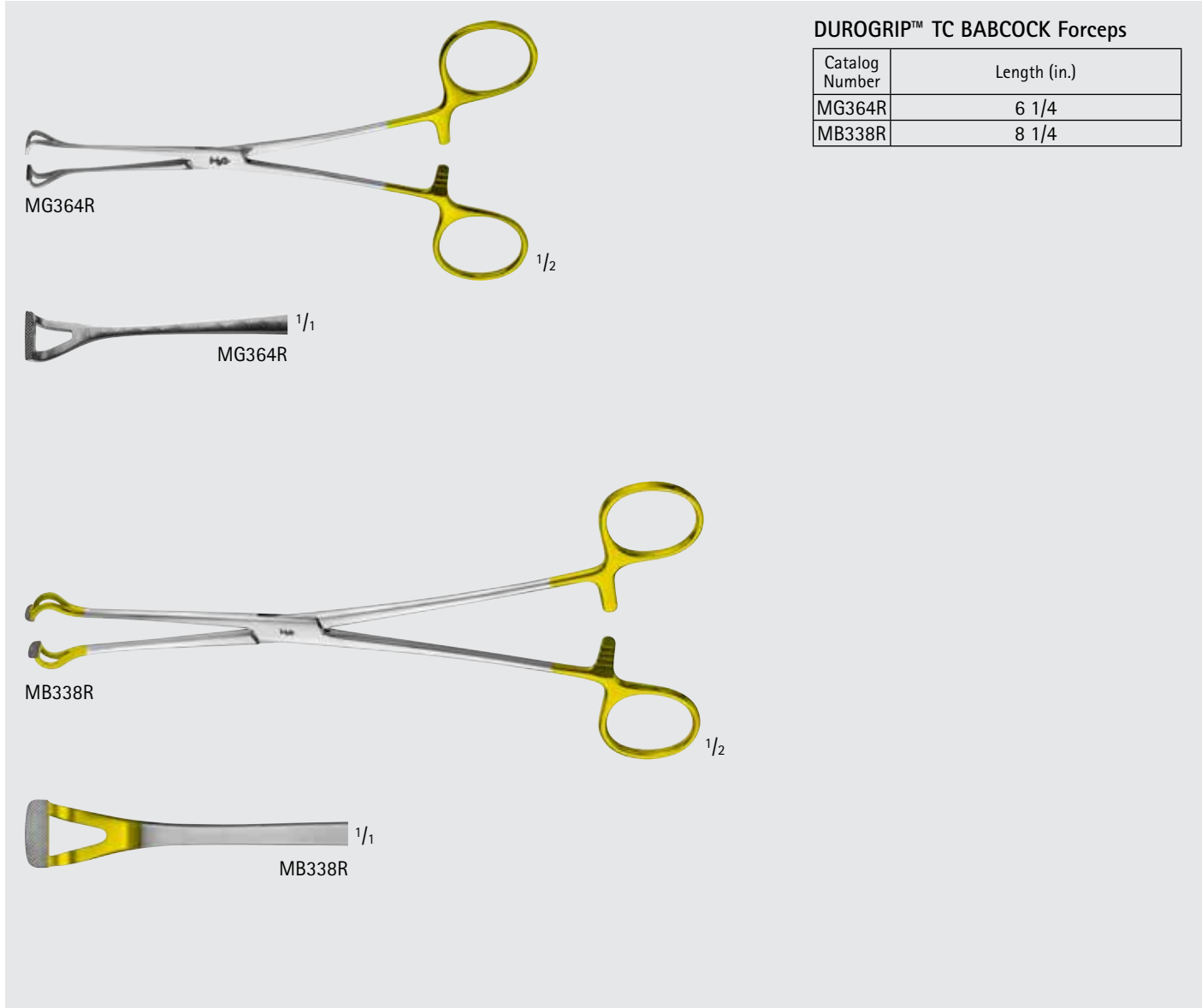
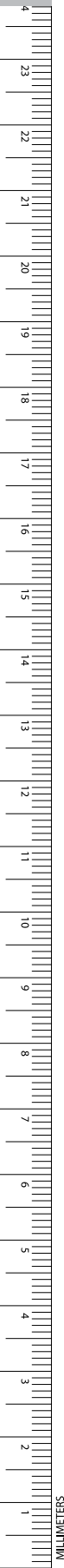

**DUROGRIP™ TC BABCOCK Forceps**

Catalog Number	Length (in.)
MG364R	6 1/4
MB338R	8 1/4

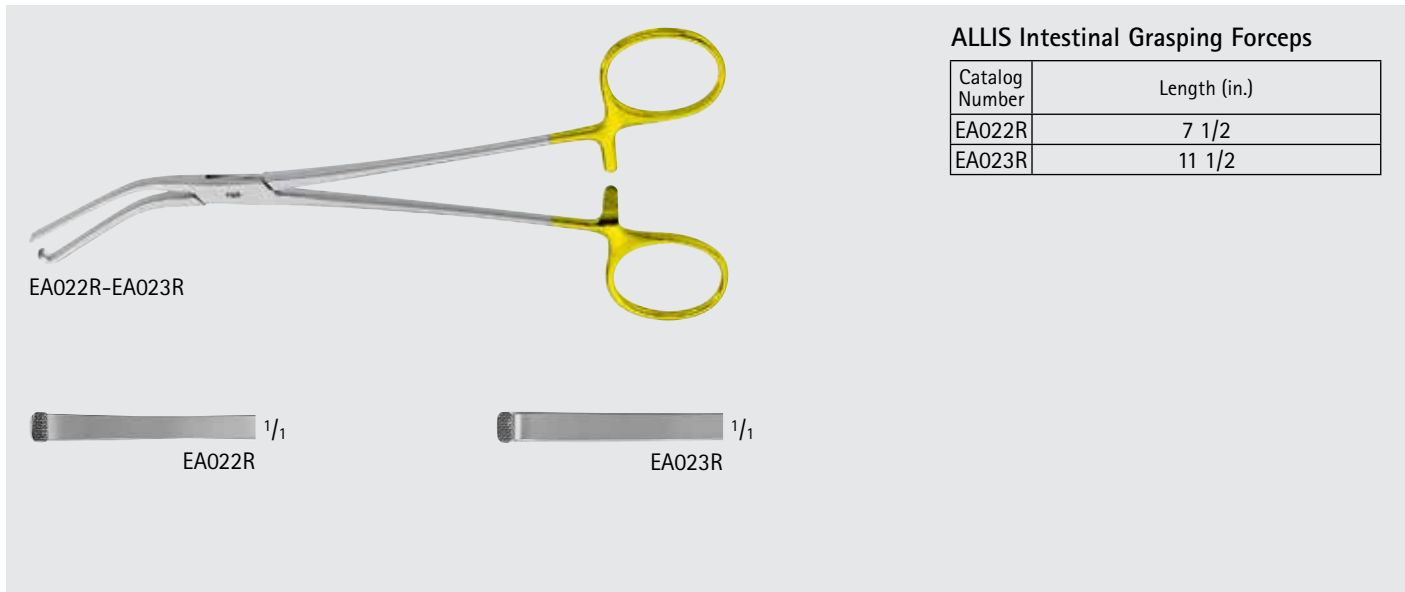

**ALLIS Intestinal Grasping Forceps**

Catalog Number	Length (in.)
EA022R	7 1/2
EA023R	11 1/2

COLLIN Intestinal Forceps

Catalog Number	Length (in.)
EA039R	5 1/2
EA040R	7

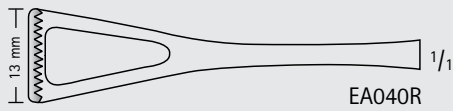
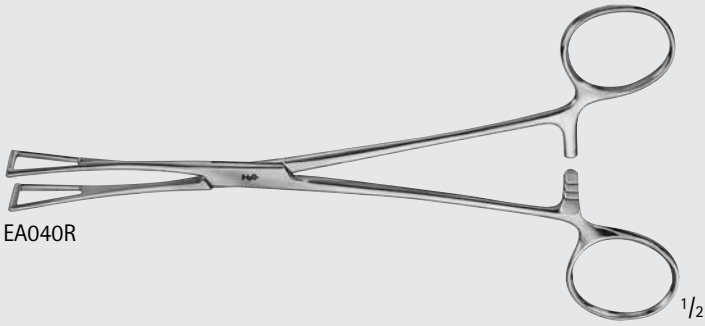
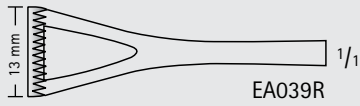
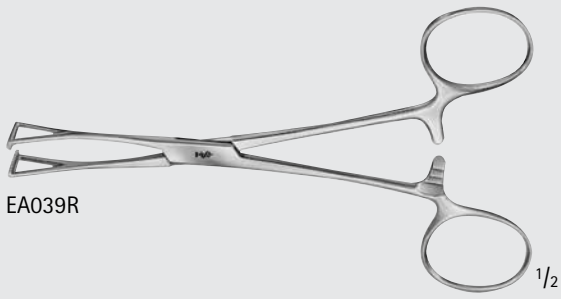

COLLIN Atraumatic Forceps

Catalog Number	Length (in.)
EA061R	7 3/4
EA062R	9

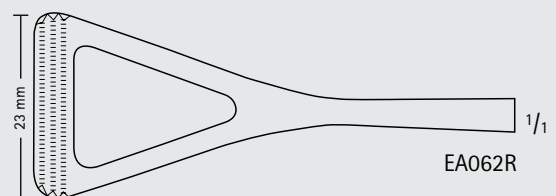
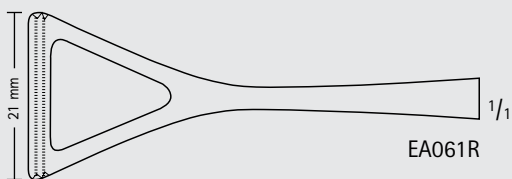
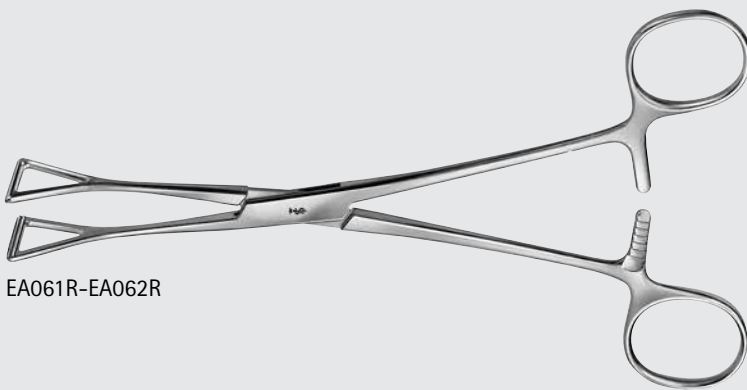

# General Surgery

## Abdominal and Intestinal Grasping Forceps



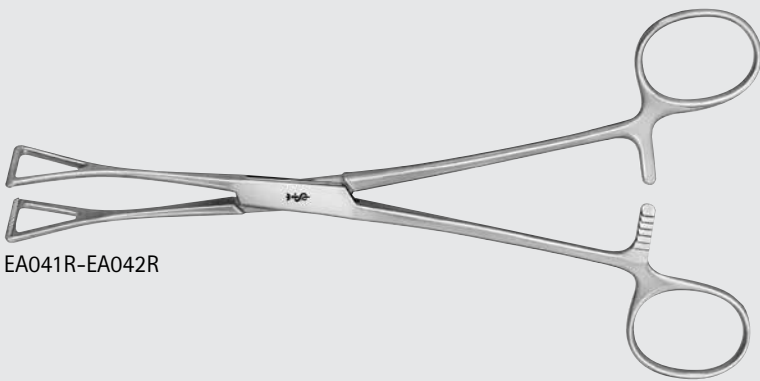

EA041R-EA042R

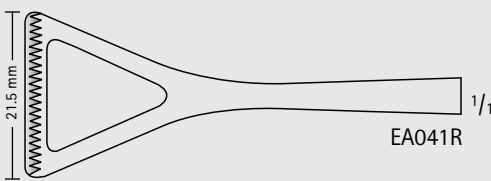

21.5 mm  
EA041R

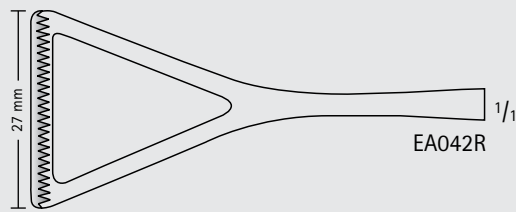

27 mm  
EA042R

**DUVAL-COLLIN Intestinal Forceps**

Catalog Number	Length (in.)
EA041R	7 3/4
EA042R	7 7/8

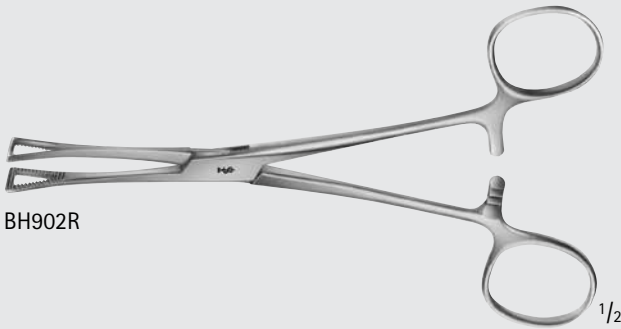

BH902R

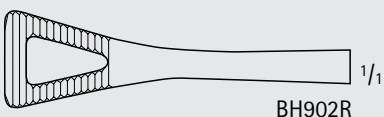

1/1  
BH902R

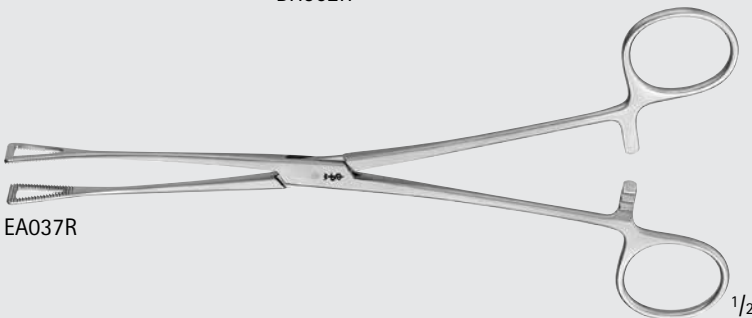

EA037R

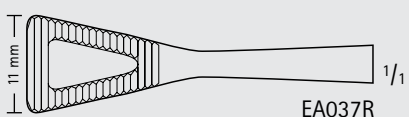

11 mm  
EA037R

**PENNINGTON Forceps**

Catalog Number	Length (in.)
BH902R	6 1/8
EA037R	7 7/8



**BAINBRIDGE Intestinal Forceps, Longitudinal Serrations**

Catalog Number	Jaw	Length (in.)
EA106R	STR	6 1/8
US114	STR	7 1/4
EA107R	CVD	6 1/8
US115	CVD	7 1/4

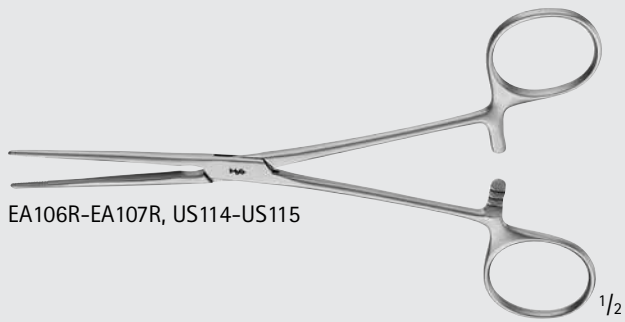

EA106R-EA107R, US114-US115

1/2



EA106R

1/1



EA107R

1/1



US114

1/1



US115

3 3

**ALLEN Intestinal Forceps, Longitudinal Serrated**

Catalog Number	Teeth	Length (in.)
EA114R	1 x 2	6 1/8
MB609R	1 x 2	7 7/8

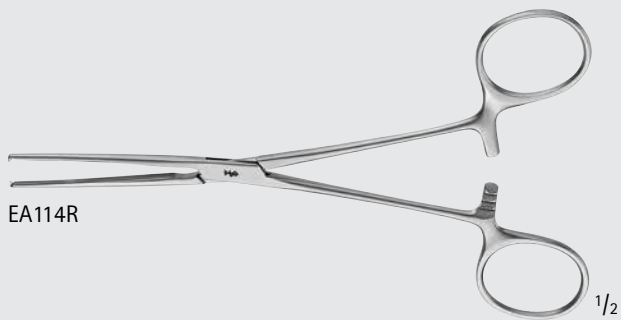

EA114R

1/2



EA114R

1/1

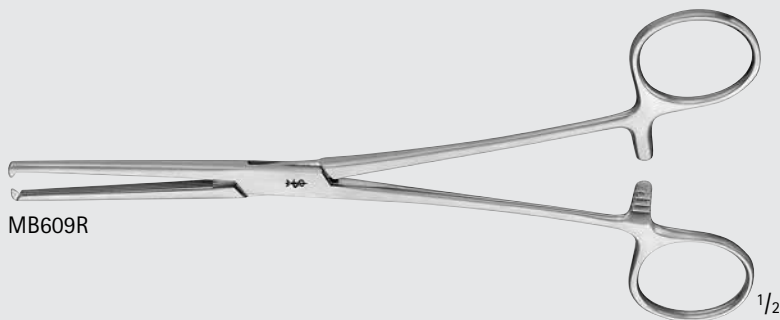

MB609R

1/2



MB609R

1/1

# General Surgery

## Abdominal and Intestinal Forceps

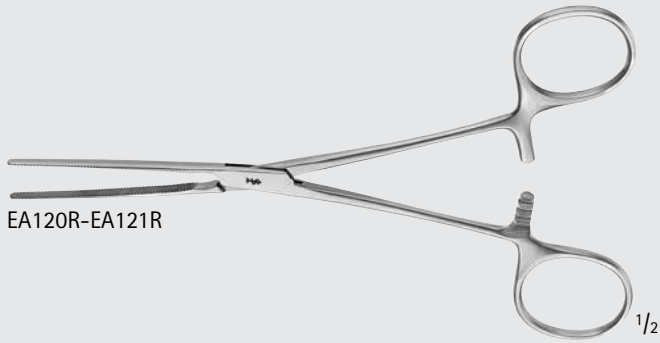
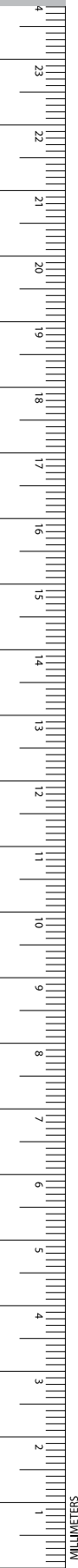

EA120R-EA121R



EA120R



EA121R

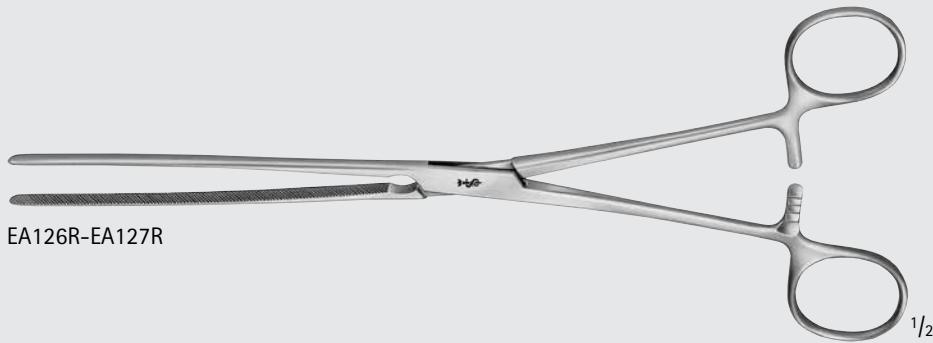

EA126R-EA127R



EA126R

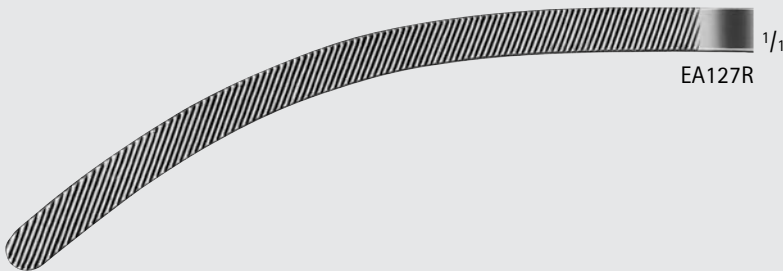

EA127R

### DOYEN Intestinal Forceps, Elastic Blades

Catalog Number	Jaw	Length (in.)
EA120R	STR	6 1/2
EA126R	STR	9 1/4
EA121R	CVD	6 1/2
EA127R	CVD	9 1/4

**DOYEN Intestinal Forceps, Elastic Blades, Longitudinal Serations**

Catalog Number	Jaw	Length (in.)
EA130R	STR	9 1/2
EA131R	CVD	9 1/2

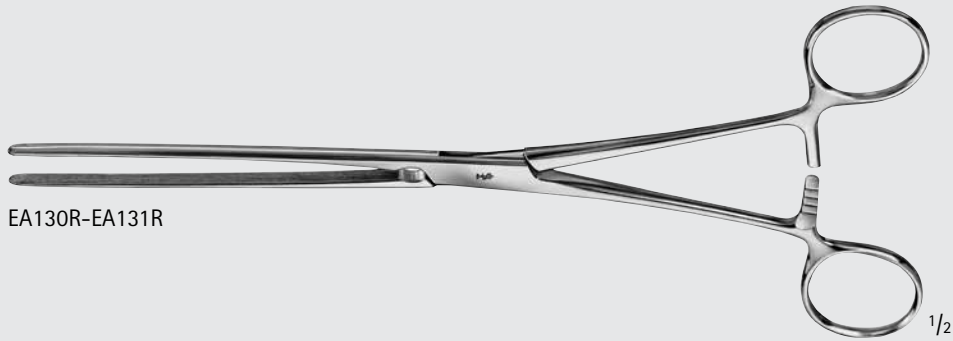

EA130R-EA131R



EA130R

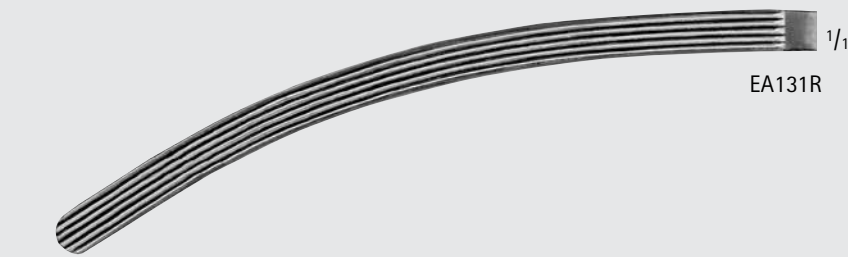

EA131R

**HARTMANN Intestinal Clamp, Elastic Blades**

Catalog Number	Jaw	Length (in.)
EA124R	STR	7 7/8
EA125R	CVD	7 7/8

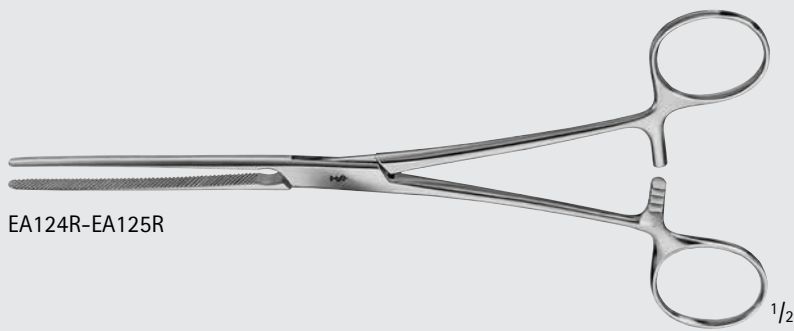

EA124R-EA125R



EA124R



EA125R



# General Surgery

## Abdominal and Intestinal Forceps

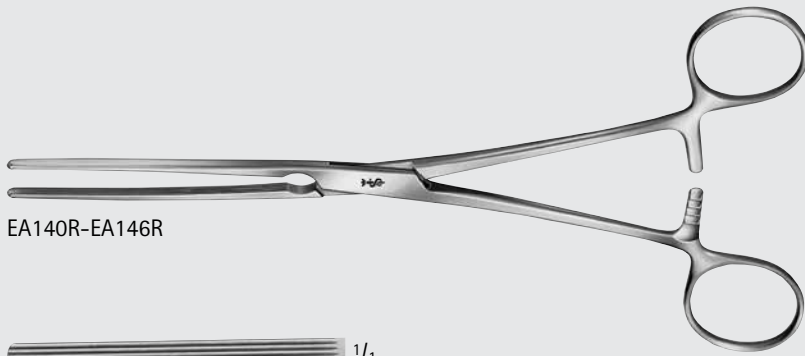

EA140R-EA146R



EA116R



EA140R



EA145R

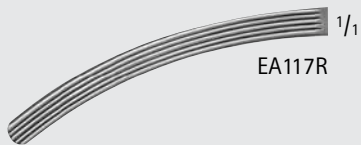

EA117R



EA141R

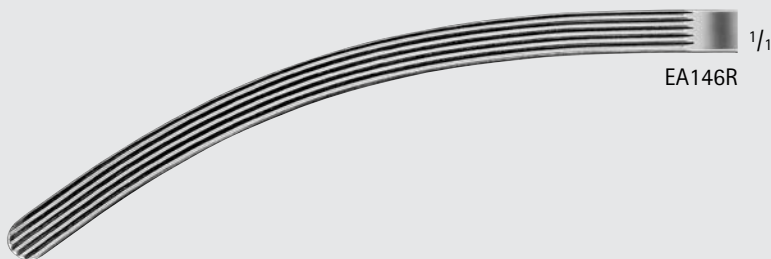

EA146R

### KOCHER Intestinal Forceps, Elastic Blades

Catalog Number	Jaw	Length (in.)
EA116R	STR	6 1/8
EA140R	STR	8 1/4
EA145R	STR	9
EA117R	CVD	5 1/4
EA141R	CVD	8 1/4
EA146R	CVD	9

KOCHER Intestinal Forceps, Elastic Blades

Catalog Number	Jaw	Length (in.)
EA150R	STR	8 3/4
EA151R	STR	9 3/4
EA152R	STR	11
EA155R	CVD	8 3/4
EA156R	CVD	9 3/4

EA150R-EA156R

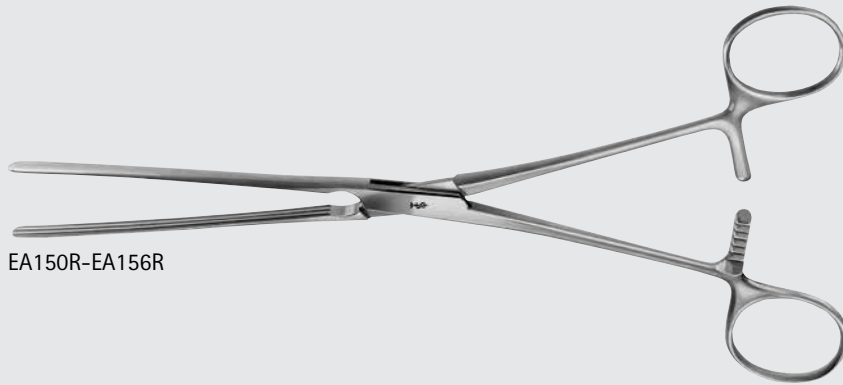

EA150R



EA151R



EA152R



EA155R



EA156R



INCHES

# General Surgery

## Abdominal and Intestinal Forceps

MAYO-ROBSON Intestinal Forceps,  
Hard Elastic Blades

Catalog Number	Jaw	Length (in.)
EA170R	STR	9 3/4
EA171R	CVD	9 3/4

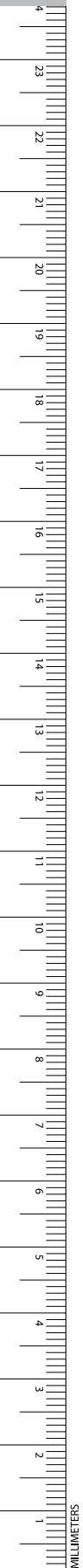
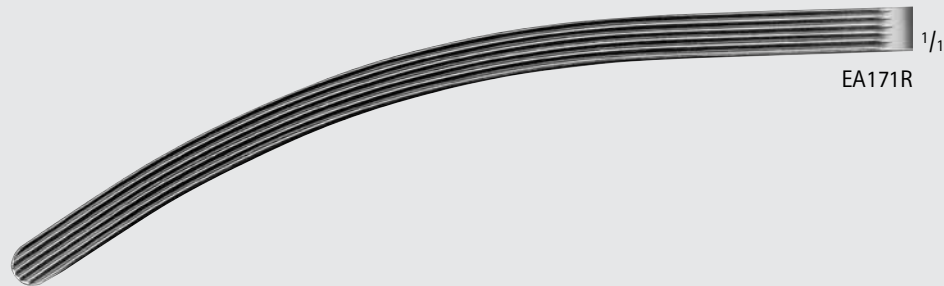
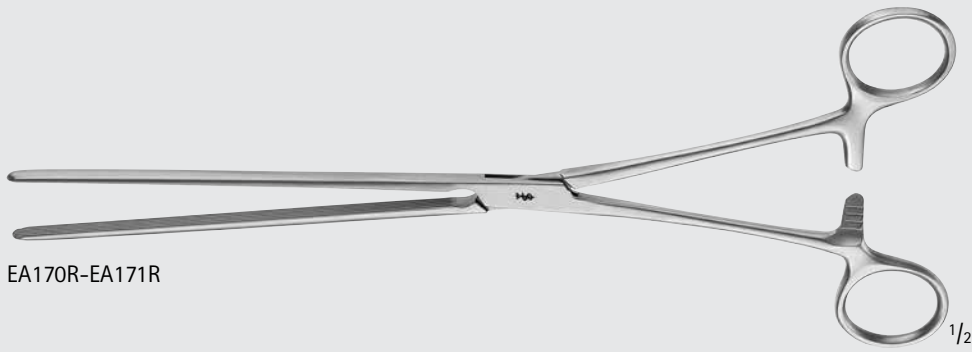

# General Surgery

## Abdominal and Intestinal Forceps



EA305R-EA450R

### PAYR Intestinal Clamp

Catalog Number	Length (in.)
EA305R	7
EA306R	7 7/8
EA309R	10 3/4
EA450R	12 1/2

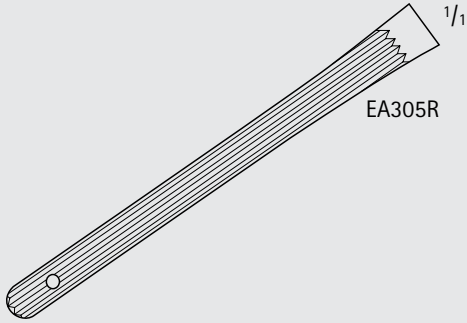

EA305R

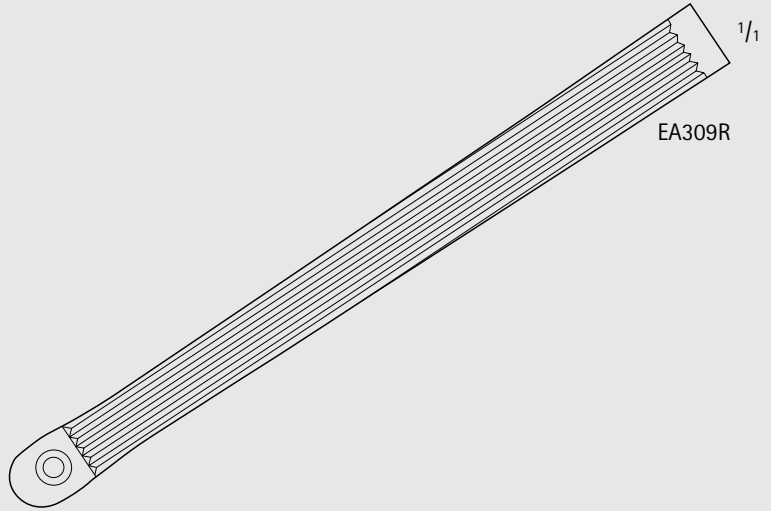

EA309R

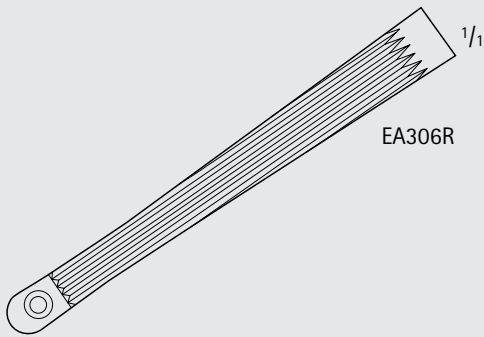

EA306R

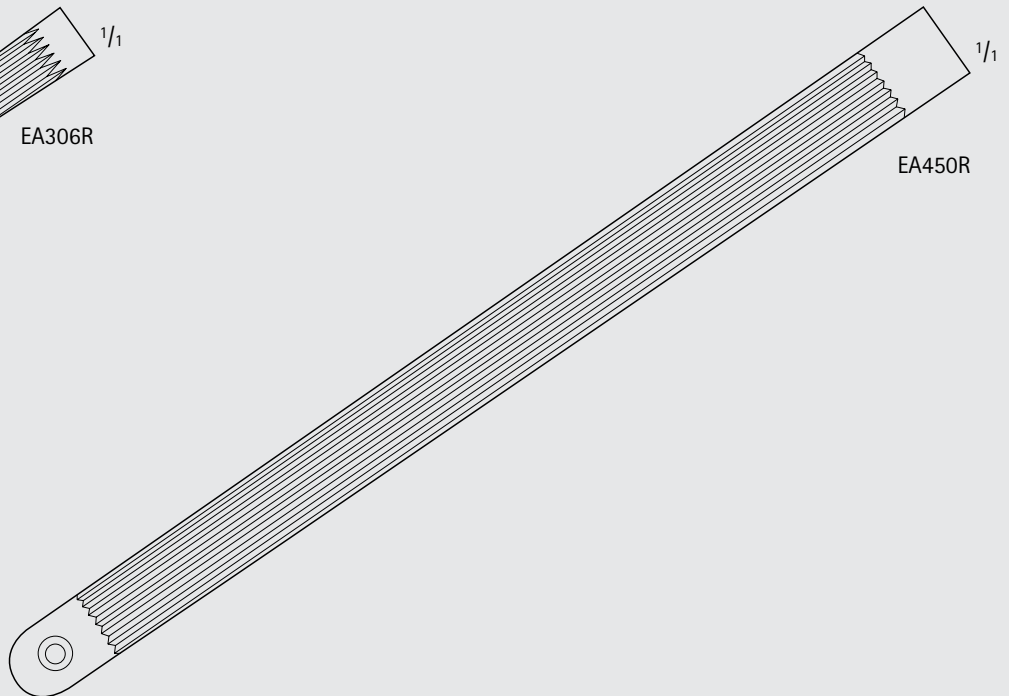

EA450R



# General Surgery

## Abdominal and Intestinal Forceps

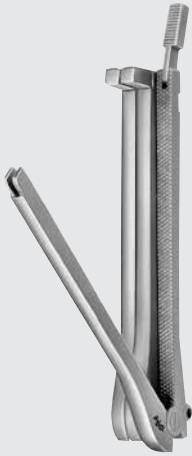

EA331R-EA332R

### DEMARTEL-WOLFSON Anastomosis Clamp

Catalog Number	Description	Length (in.)
EA331R	SET OF 3	4
EA332R	SET OF 3	4 3/4



EA334R

### Clamp Holder for Anastomosis Clamp

Catalog Number	Description	Length (in.)
EA334R	3" FOR USE WITH EA331R-EA332R	3 1/8

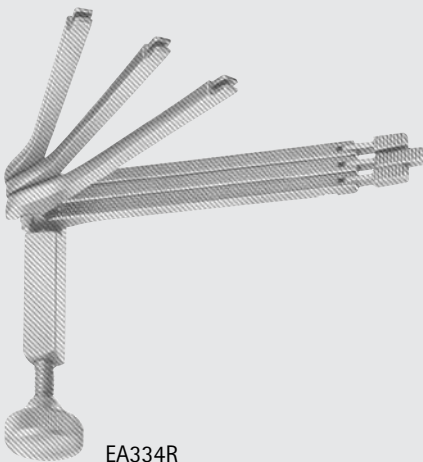

EA334R



# General Surgery

## Abdominal and Intestinal Forceps

GENERAL SURGERY

### KLEINSCHMIDT Appendectomy Forceps

Catalog Number	Jaw	Length (in.)
EA397R	CVD	5 1/8

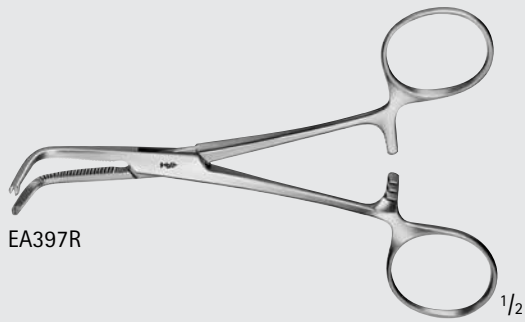

### BENSON Pylorus Spreader

Catalog Number	Length (in.)
EA466R	6 1/8

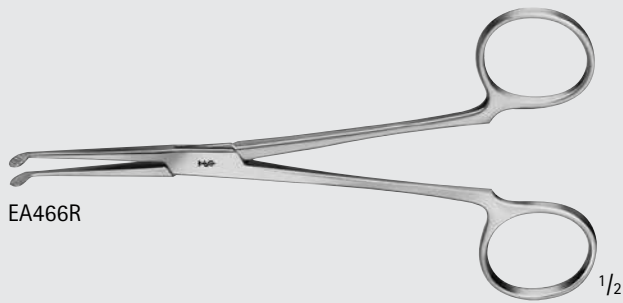

### TAUFIC Cholangiography Clamp

Catalog Number	Length (in.)
MG454R	8 1/2

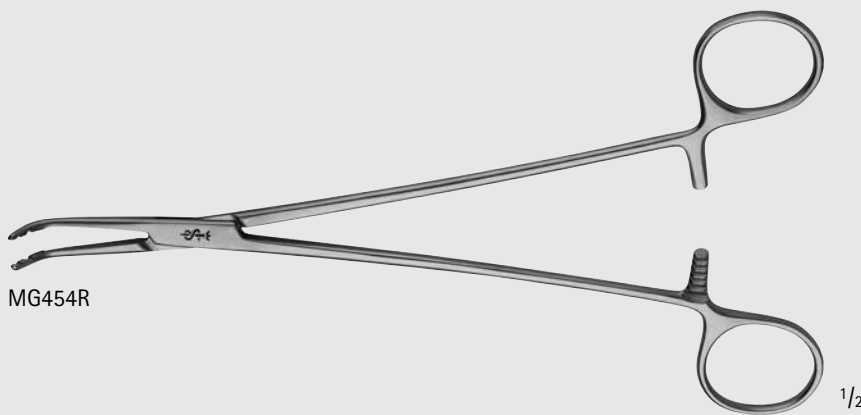

INCHES

# General Surgery

## Abdominal and Intestinal Forceps

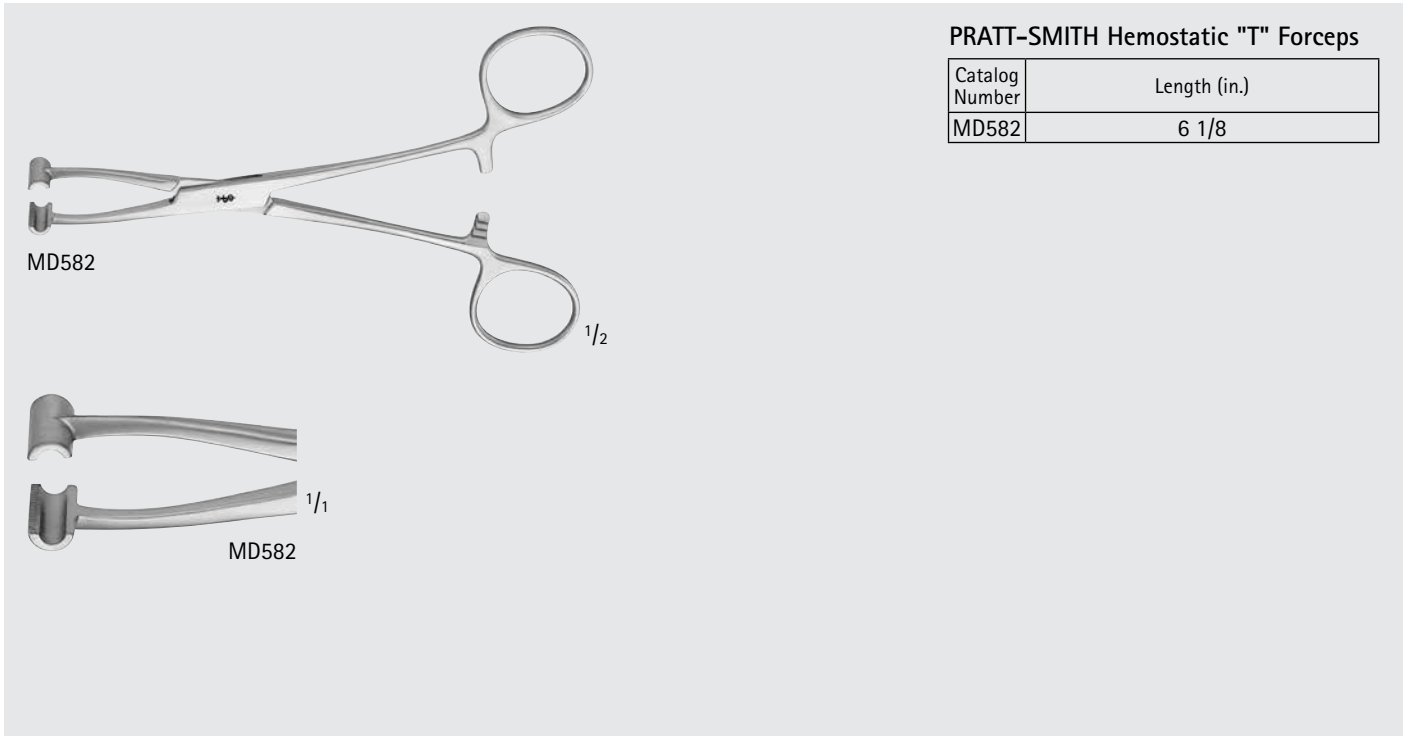

**PRATT-SMITH Hemostatic "T" Forceps**

Catalog Number	Length (in.)
MD582	6 1/8

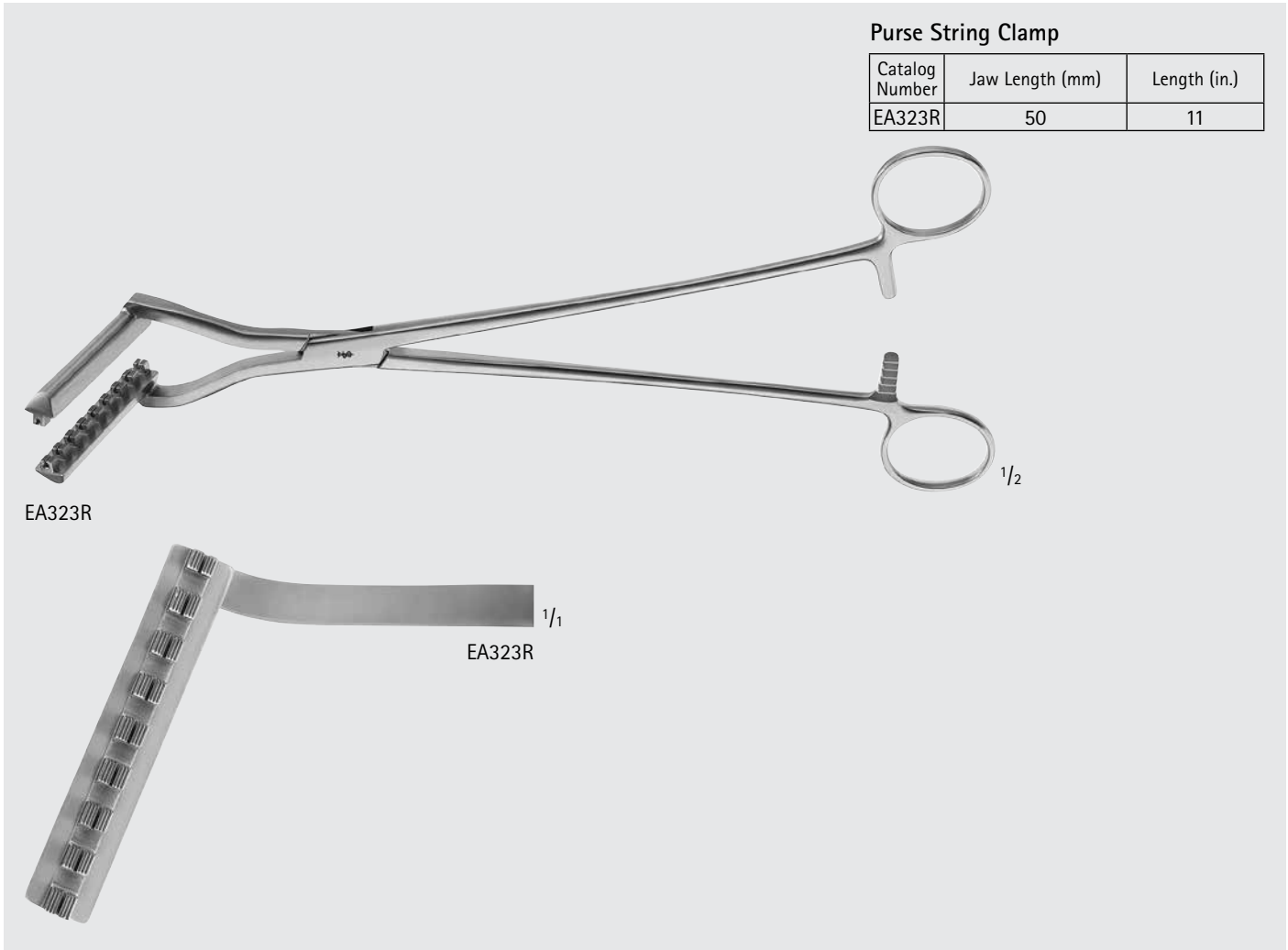

**Purse String Clamp**

Catalog Number	Jaw Length (mm)	Length (in.)
EA323R	50	11

LOWER Gall Duct Forceps

Catalog Number	Jaw	Length (in.)
EB001R	HEAVY-CVD	7

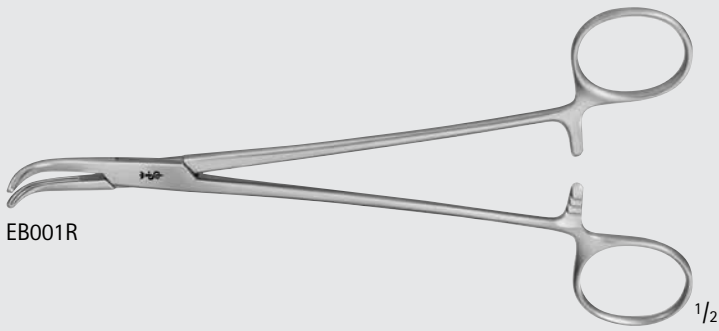

LAHEY (SWEET) Gall Duct Forceps

Catalog Number	Jaw	Length (in.)
EB003R	CVD	7 7/8

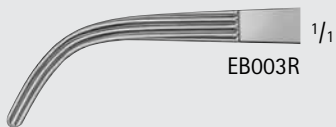
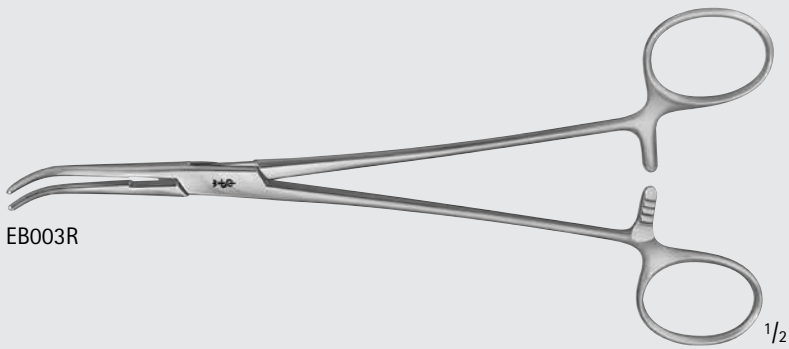

DESJARDINS Gall Duct Forceps

Catalog Number	Jaw	Length (in.)
EB008R	HEAVY-CVD	8 3/4

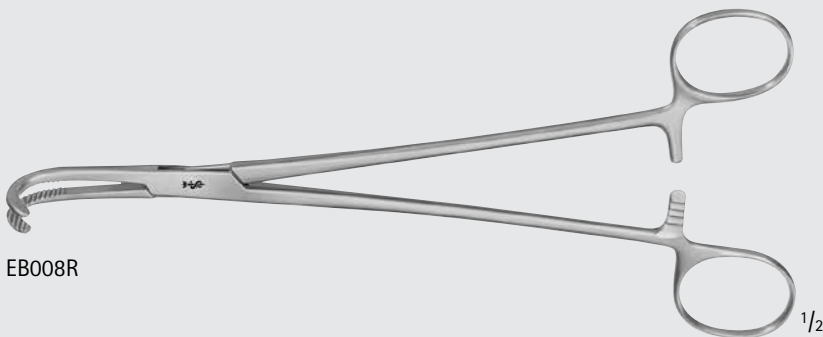

# General Surgery

## Abdominal and Intestinal Forceps

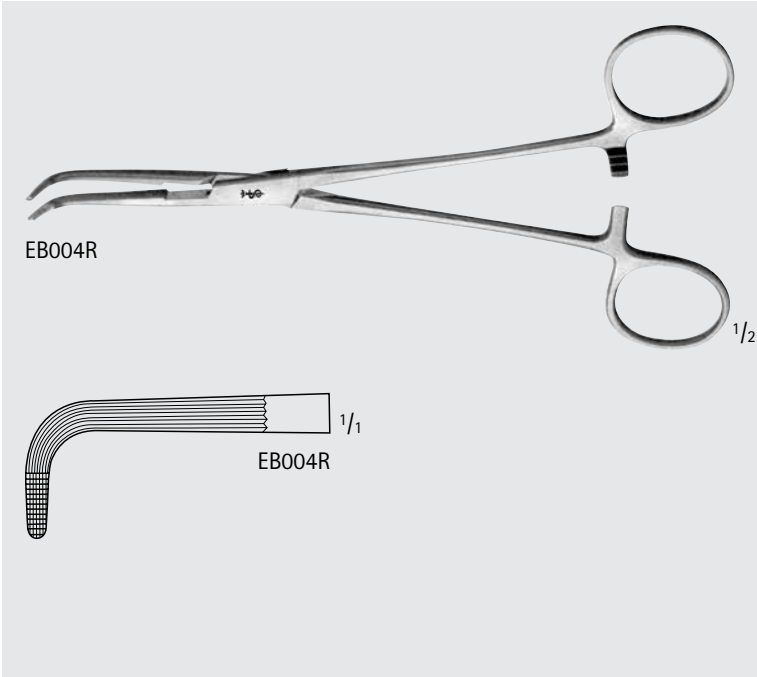

**LAHEY Gall Duct Forceps**

Catalog Number	Jaw	Length (in.)
EB004R	HEAVY-CVD	7 1/2

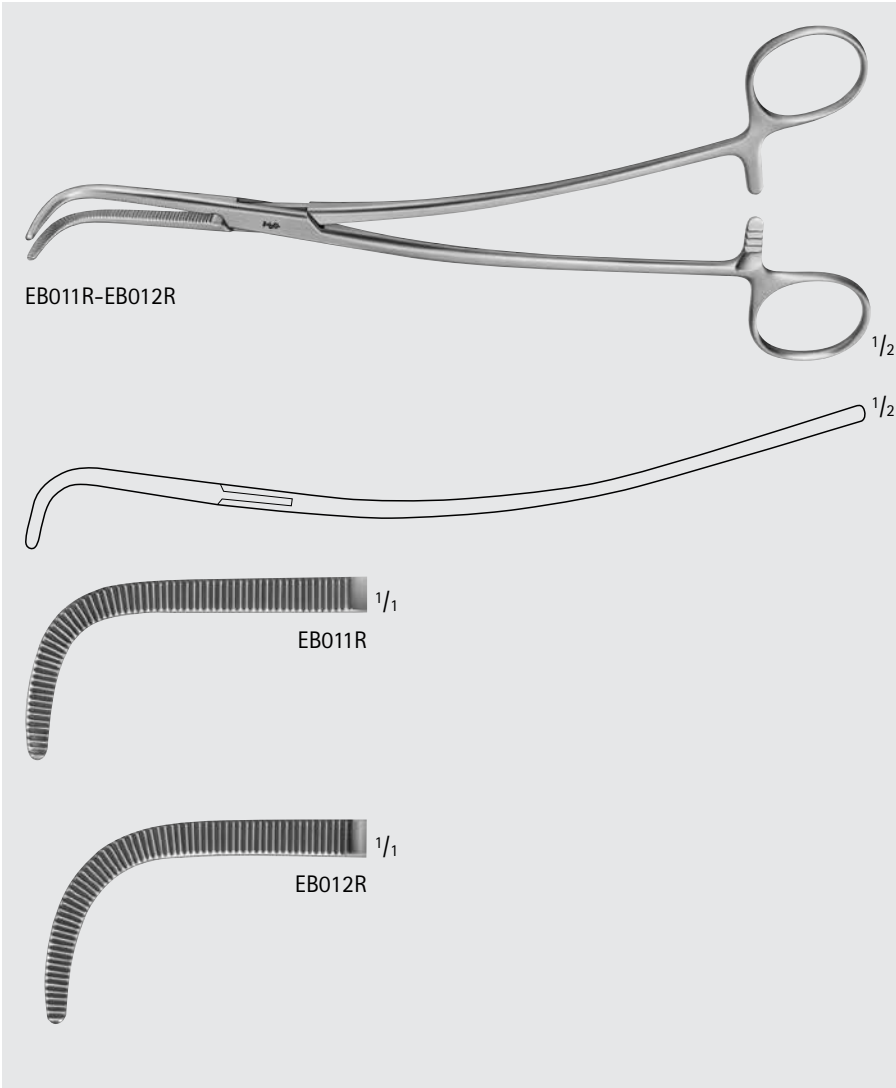

**GRAY Cystic Gall Duct Forceps**

Catalog Number	Jaw	Length (in.)
EB011R	SHORT, CVD	8 3/4
EB012R	LONG, CVD	8 3/4

MIXTER Gall Duct Forceps

Catalog Number	Jaw	Length (in.)
MB120R	HEAVY-CVD	6 1/4

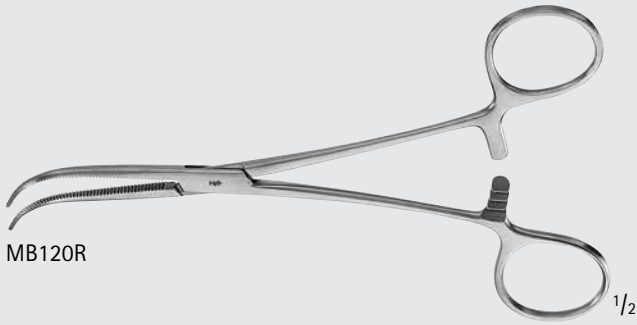

MB120R

1/2



MB120R

1/1

SHALLCROSS Cystic Duct Forceps

Catalog Number	Jaw	Length (in.)
MB126R	CVD	6 7/8
US152	FULL-CVD	8

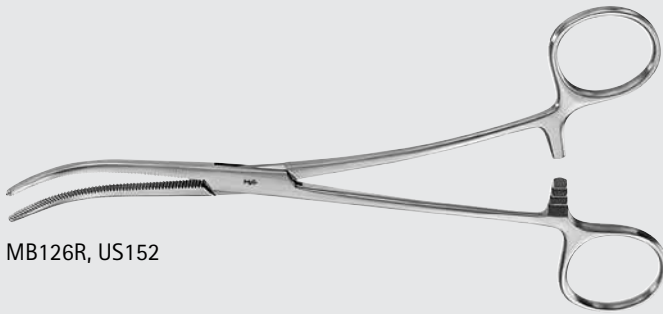

MB126R, US152



MB126R

1/1



US152

1/1

BLAKE Gall Stone Forceps

Catalog Number	Jaw	Length (in.)
EB220R	STR	8
EB221R	CVD	8

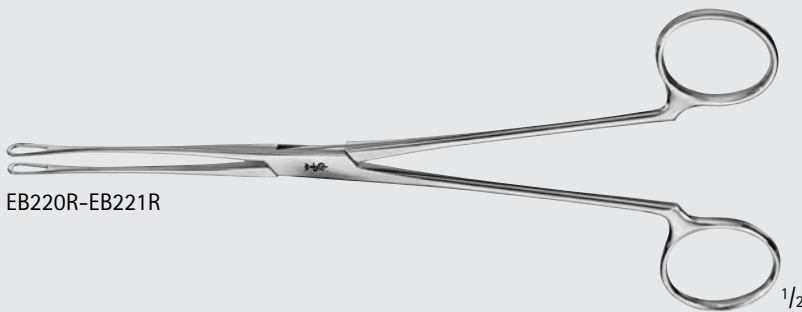

EB220R-EB221R

1/2



EB220R

1/1

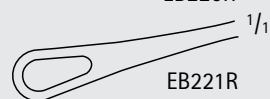

EB221R

1/1



INCHES

# General Surgery

## Abdominal and Intestinal Forceps

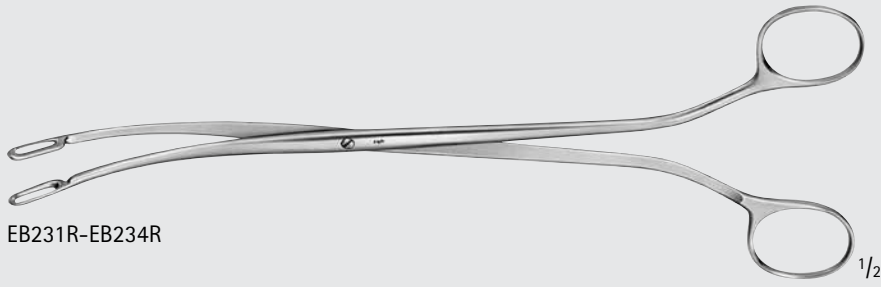

EB231R-EB234R

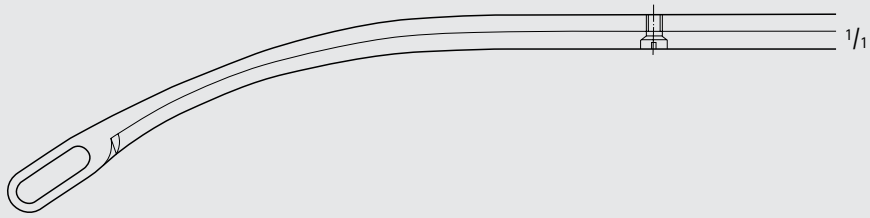

EB231R



EB232R



EB233R



EB234R

### DESJARDINS Gall Stone Forceps

Catalog Number	Tip	Length (in.)
EB231R	OVAL	8 7/8
EB232R	OVAL	8 7/8
EB233R	TAPERED	8 7/8
EB234R	TAPERED	8 7/8

**PARKER-KERR Forceps**

Catalog Number	Jaw	Length (in.)
EA365R	SLIGHT-CVD	9 3/4



**HEIMING Kidney Stone Forceps**

Catalog Number	Jaw	Length (in.)
EF047R	SLIGHT-CVD	6 3/4
EF048R	HEAVY-CVD	6 1/4

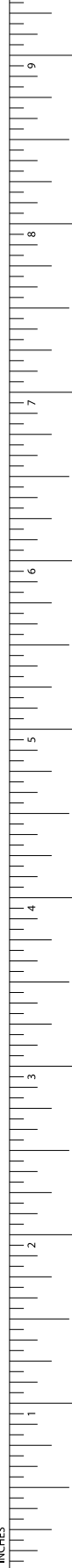
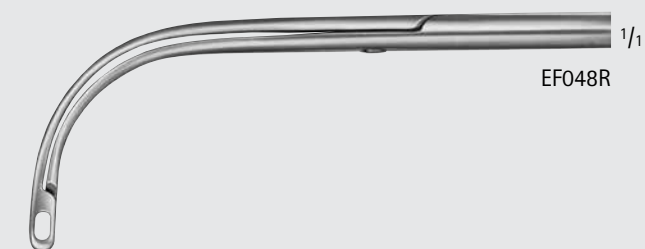
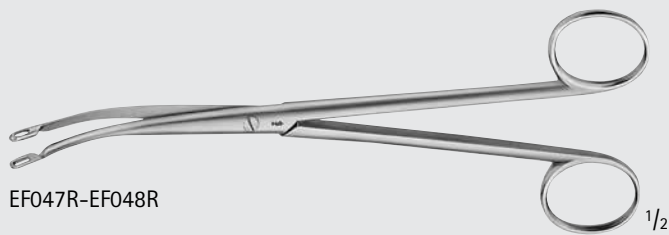

# General Surgery

## Abdominal and Intestinal Forceps

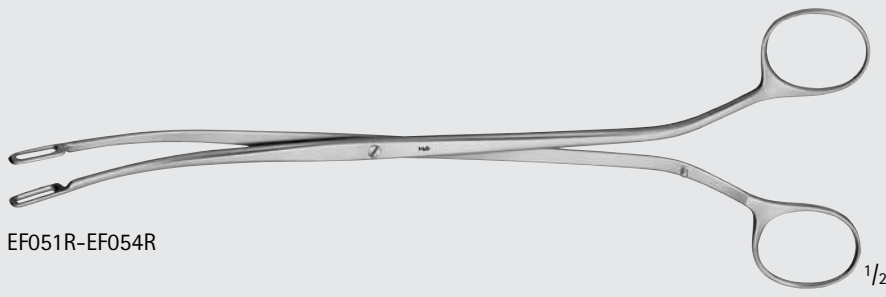
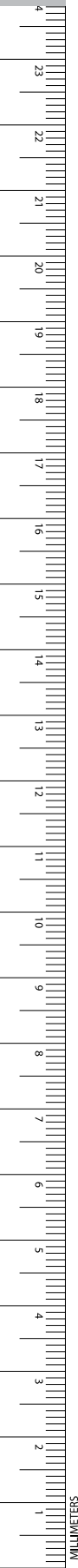

EF051R-EF054R

### RANDALL Kidney Stone Forceps

Catalog Number	Jaw	Length (in.)
EF051R	SLIGHT-CVD	8 7/8
EF052R	CVD	8 7/8
EF053R	HEAVY-CVD	8 7/8
EF054R	U-CVD	8 7/8



EF051R

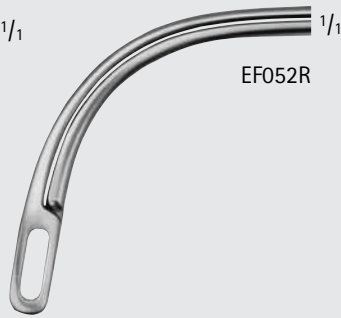

EF052R



EF053R

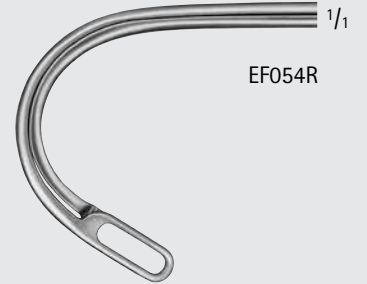

EF054R



1/16

RANDALL Kidney Stone Forceps  
(continued)

Catalog Number	Jaw	Length (in.)
EF055R	CVD	7 1/2
EF056R	HEAVY-CVD	7 1/2
EB244R	90° ANG	9 5/8
EB246R	HEAVY-CVD, DEL	9

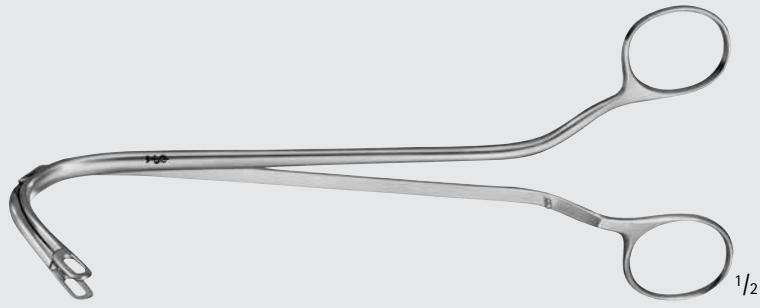

EF055R-EF056R

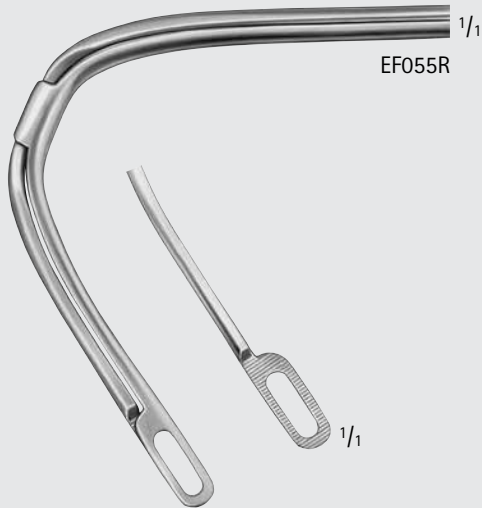

EF055R

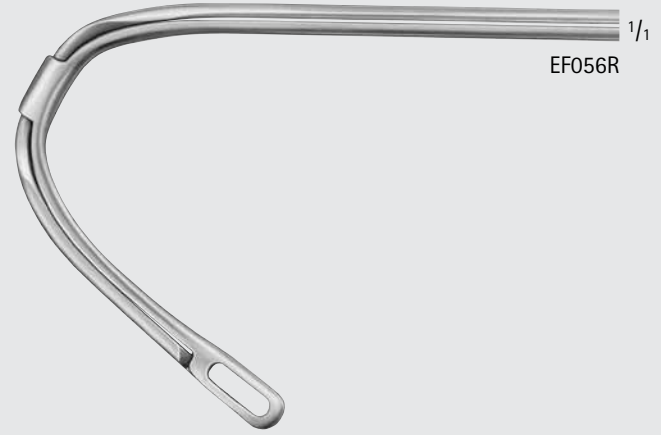

EF056R

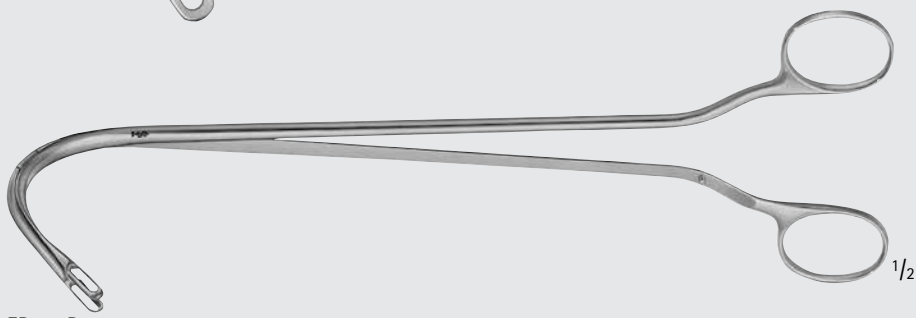

EB244R



EB244R

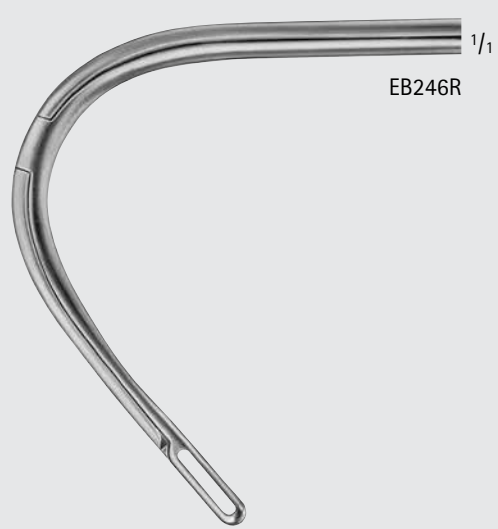

EB246R



INCHES

# General Surgery

## Atraumatic Intestinal Forceps and Clamps

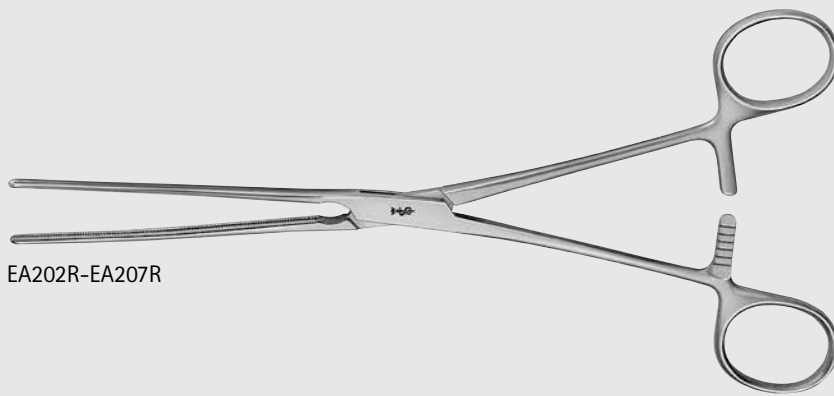

EA202R-EA207R

**KOCHER Atraumatic Forceps,  
Elastic Blades**

Catalog Number	Jaw	Length (in.)
EA202R	STR	8 3/4
EA204R	STR	9 3/4
EA206R	STR	11
EA203R	CVD	8 3/4
EA205R	CVD	9 3/4
EA207R	CVD	11



EA202R



EA204R



EA206R

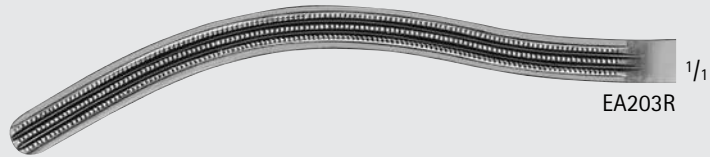

EA203R



EA205R



EA207R

# General Surgery

## Atraumatic Intestinal Forceps and Clamps

### HARTMANN Atraumatic Forceps, Elastic Blades

Catalog Number	Jaw	Length (in.)
EA210R	STR	7 7/8
EA211R	CVD	7 7/8

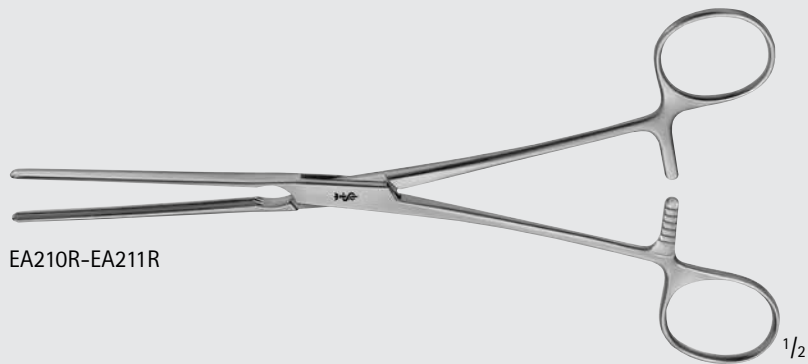

EA210R-EA211R



EA210R

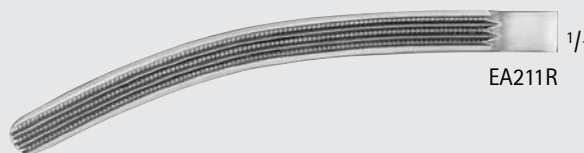

EA211R

### MAYO-ROBSON Atraumatic Forceps

Catalog Number	Jaw	Length (in.)
EA216R	STR	9 3/4
EA217R	CVD	9 3/4

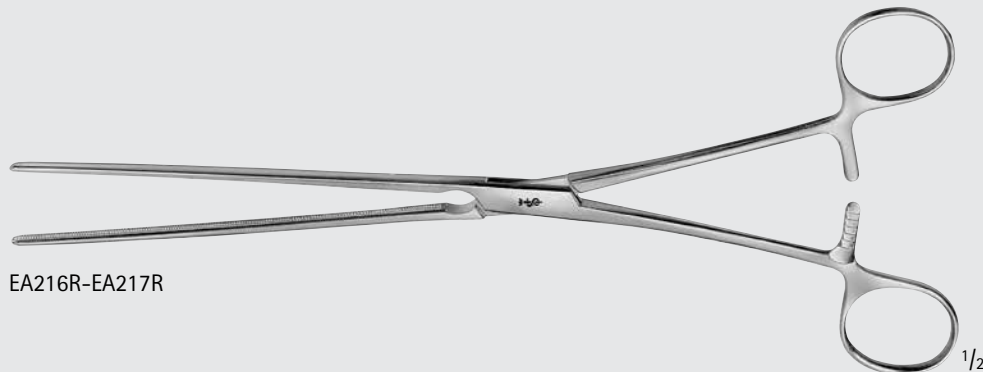

EA216R-EA217R



EA216R



EA217R

# General Surgery

## Atraumatic Intestinal Forceps and Clamps

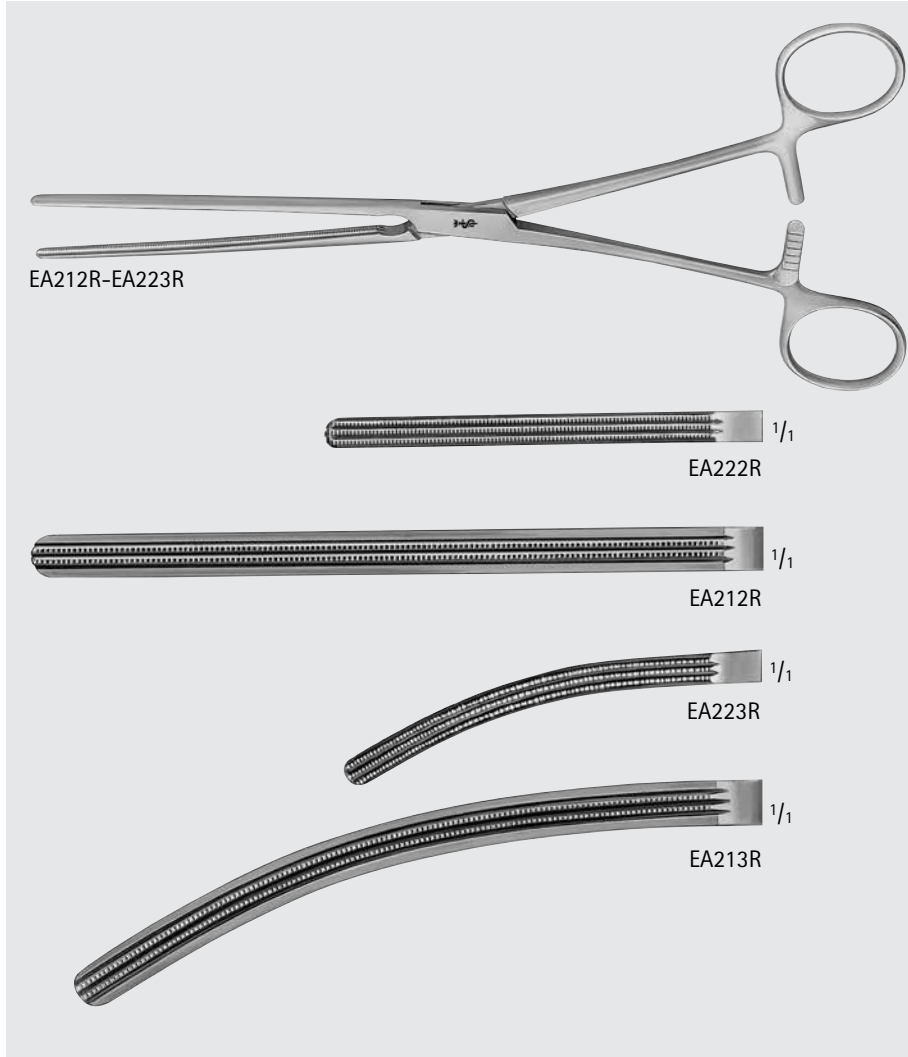

### DOYEN Atraumatic Forceps, Elastic Blades

Catalog Number	Jaw	Length (in.)
EA222R	STR	6 3/4
EA212R	STR	9
EA223R	CVD	6 3/4
EA213R	CVD	9

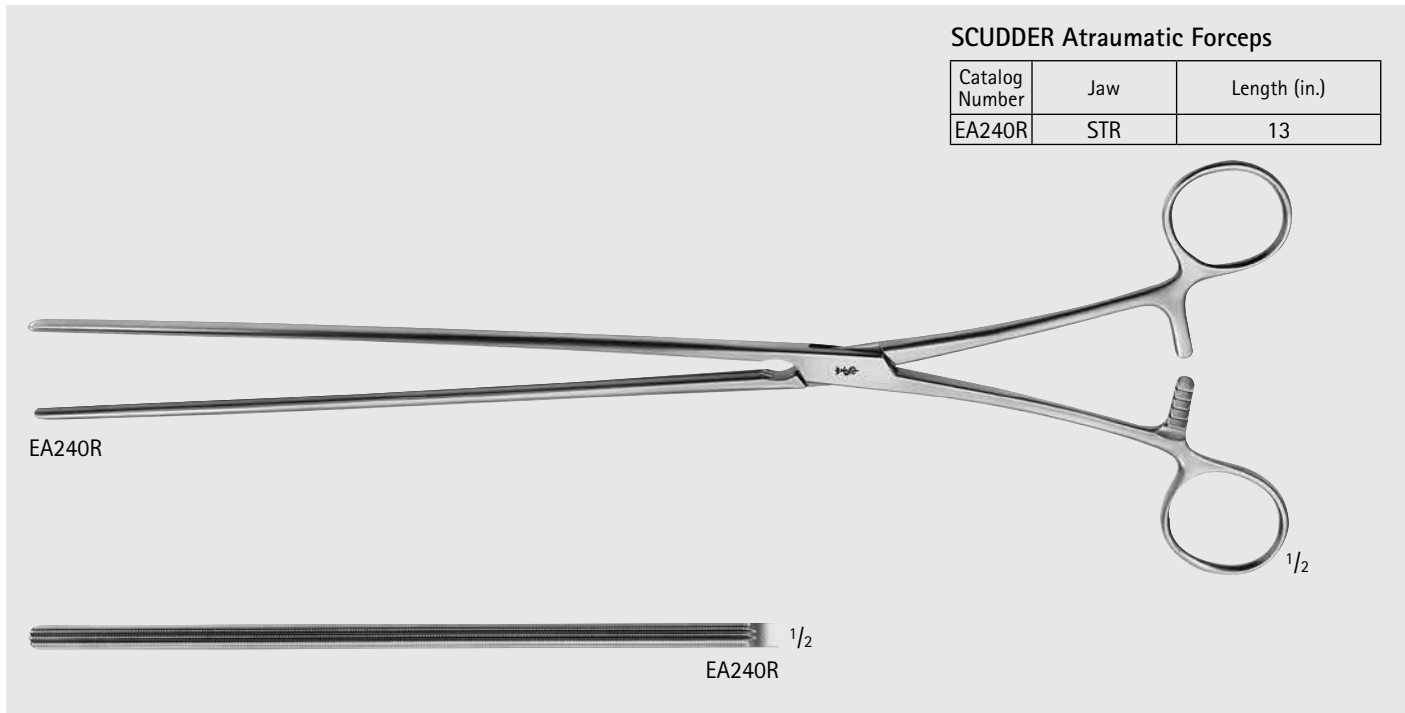

### SCUDDER Atraumatic Forceps

Catalog Number	Jaw	Length (in.)
EA240R	STR	13

# General Surgery

## Atraumatic Intestinal Forceps and Clamps

### GLASSMAN Anterior Resection Clamp

Catalog Number	Jaw	Jaw Length (mm)	Length (in.)
MB931R	90°, SERR	25	9 3/4
MB130R	90°, SERR	50	9 3/4
MB932R	90°, SERR	75	10

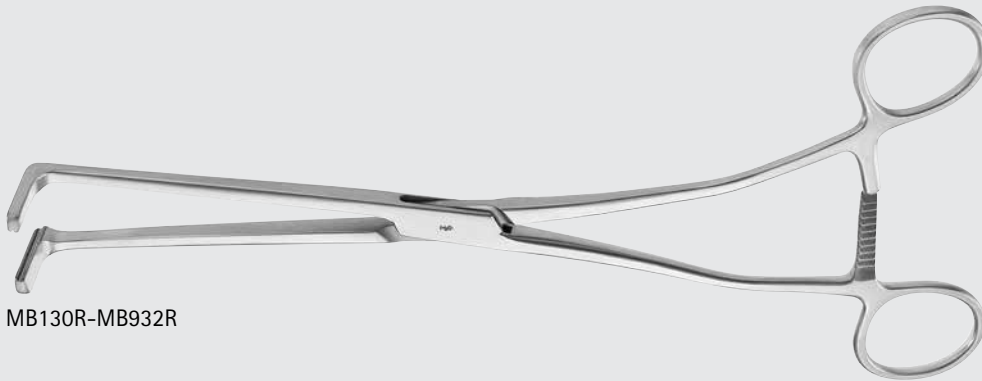

MB130R-MB932R

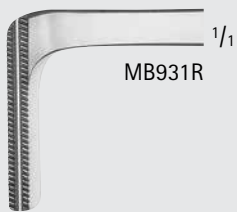

MB931R

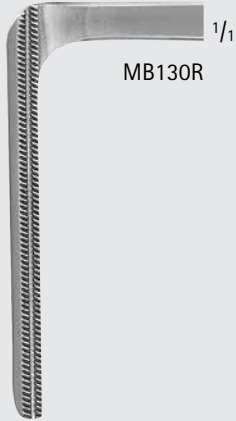

MB130R

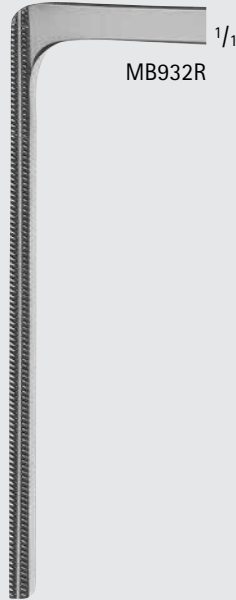

MB932R



INCHES

# General Surgery

## Atraumatic Intestinal Forceps and Clamps

**CARTER-GLASSMAN Resection Clamp**

Catalog Number	Jaw	Jaw Length (mm)	Length (in.)
MG460R	STR	110	11
MG439R	45° ANG	103	10 1/4

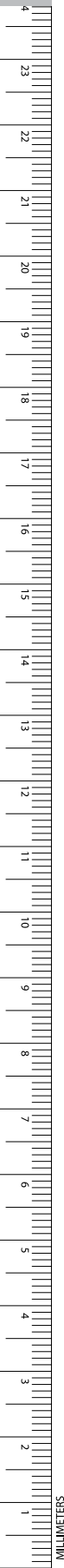
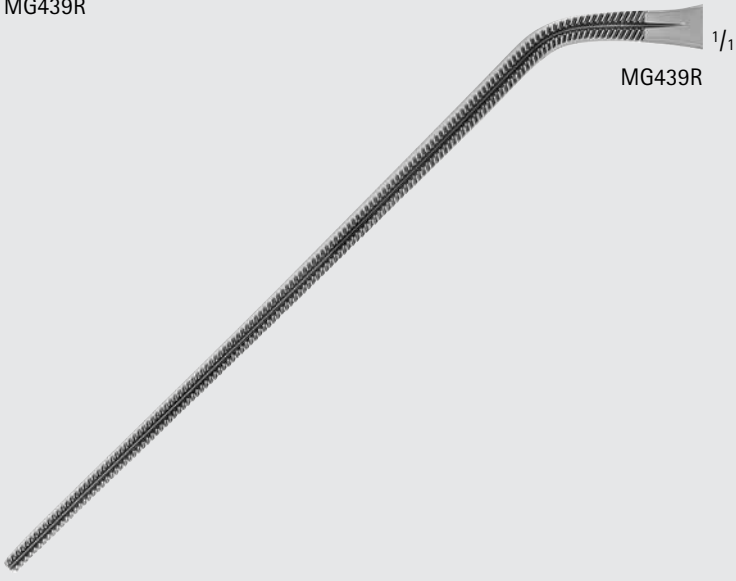
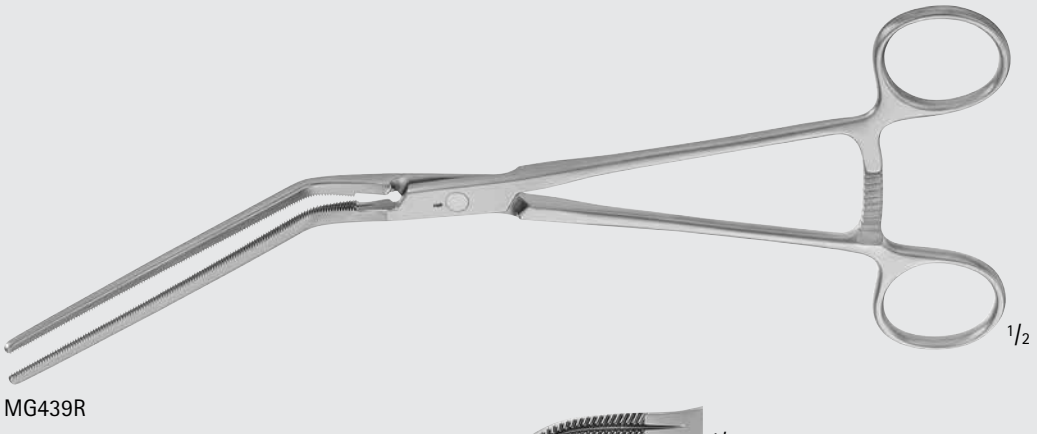
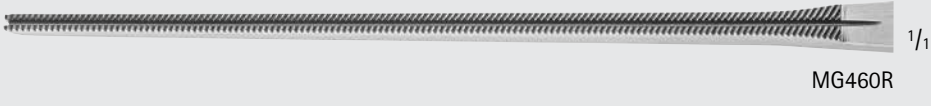

# General Surgery

## Atraumatic Intestinal Forceps and Clamps

### GLASSMAN Intestinal and Liver Holding Clamp, Non-Crushing

Catalog Number	Jaw	Length (in.)
MG436R	STR	9 3/4
MG437R	CVD	9 5/8
MG438R	FULL CVD	9



MG436R-MG438R



MG436R



MG437R



MG438R

# General Surgery

## Atraumatic Intestinal Forceps and Clamps



**GLASSMAN Gastroenterostomy Clamp**

Catalog Number	Jaw	Jaw Length (mm)	Length (in.)
MG433R	STR	116	11 1/2
MG434R	ANG	115	11 1/2



MG433R-MG434R



MG433R

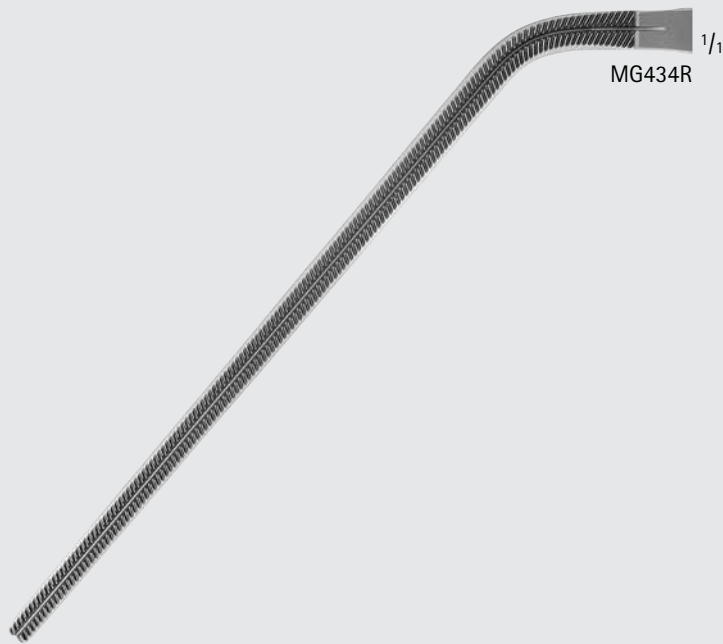

MG434R

**GLASSMAN Gastrointestinal Clamp, Non-Crushing**

Catalog Number	Jaw	Length (in.)
MB138R	STR	9 1/4
MB139R	ANG	9

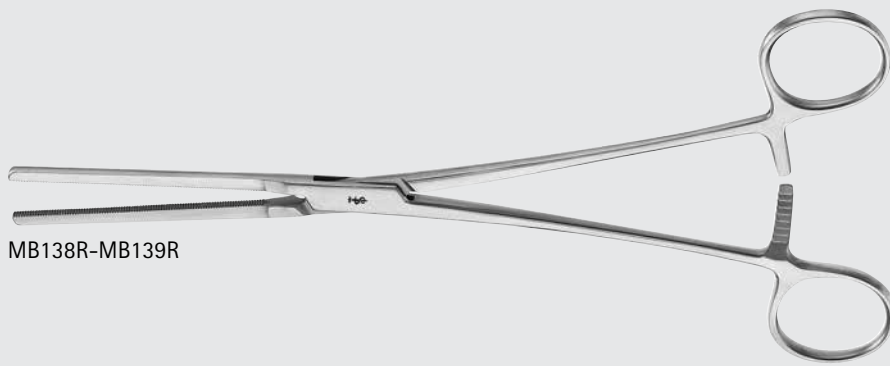

MB138R-MB139R



MB138R

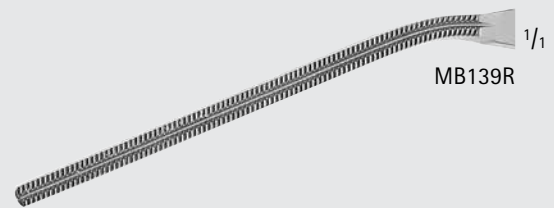

MB139R

**LISTER Sponge Forceps**

Catalog Number	Jaw	Length (in.)
BF004R	STR	5 1/4
BF006R	STR	6 1/4
BF008R	STR	7 1/4

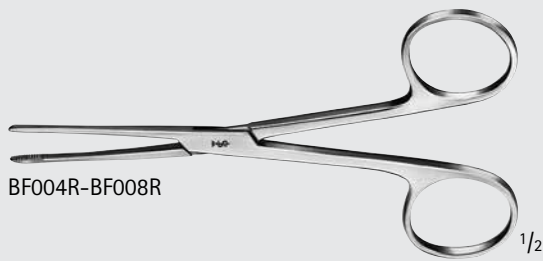

BF004R-BF008R

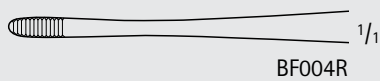

BF004R

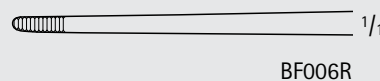

BF006R

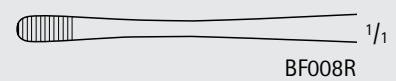

BF008R

**GROSS Forceps, W/ Ratchet**

Catalog Number	Jaw	Length (in.)
BF046R	STR	7 7/8
BF047R	CVD	7 7/8

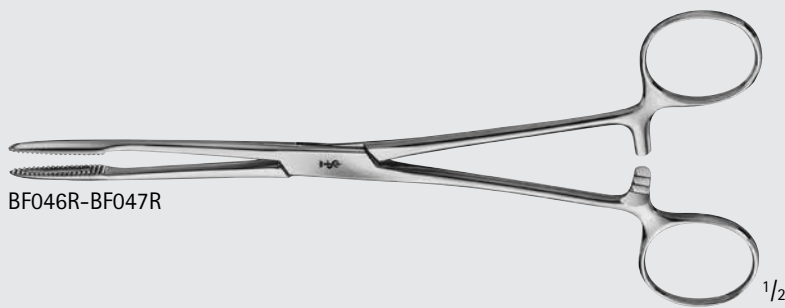

BF046R-BF047R

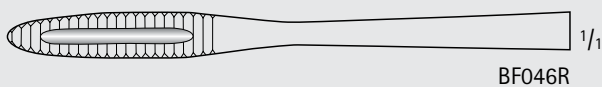

BF046R

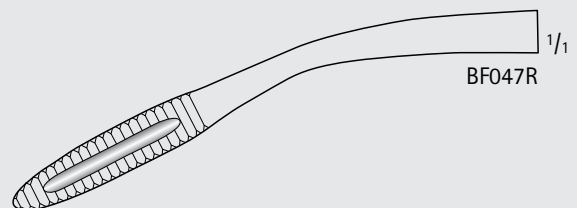

BF047R



INCHES

# General Surgery

## Dressing and Sponge Forceps



**SIMS-MAIER Sponge Forceps**

Catalog Number	Jaw	Length (in.)
BF078R	STR	13 3/4

BF078R

1/3

1/1

BF078R

**ULRICH-AESCULAP Sponge Forceps**

Catalog Number	Jaw	Length (in.)
BF062R	STR	10 1/2
BF063R	CVD	10 1/2
BF065R	CVD	13 3/4

BF062R-BF063R

1/2

1/1

BF062R

1/1

BF063R

BF065R

1/3

1/1

BF065R

# General Surgery

## Dressing and Sponge Forceps

### RAMPLEY Sponge Forceps

Catalog Number	Tip	Jaw	Length (in.)
BF116R	SERR	STR	7
BF118R	SERR	STR	9 3/4

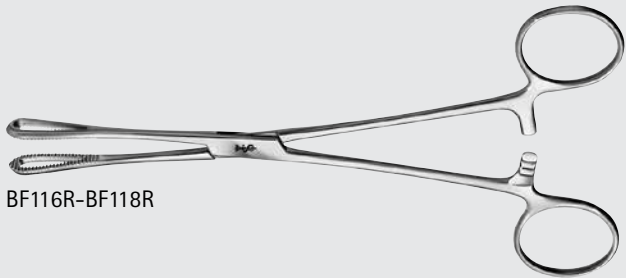

BF116R-BF118R

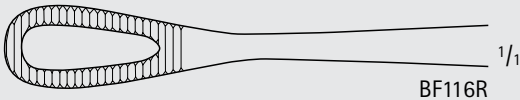

BF116R

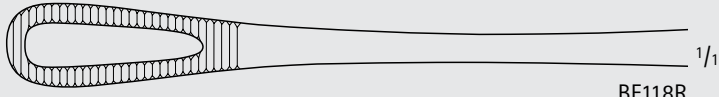

BF118R



# General Surgery

## Dressing and Sponge Forceps



### FOERSTER Sponge Forceps

Catalog Number	Tip	Jaw	Length (in.)
MB098R	SERR	STR	12
MB099R	SERR	STR	14
MB904R	SERR	STR	16

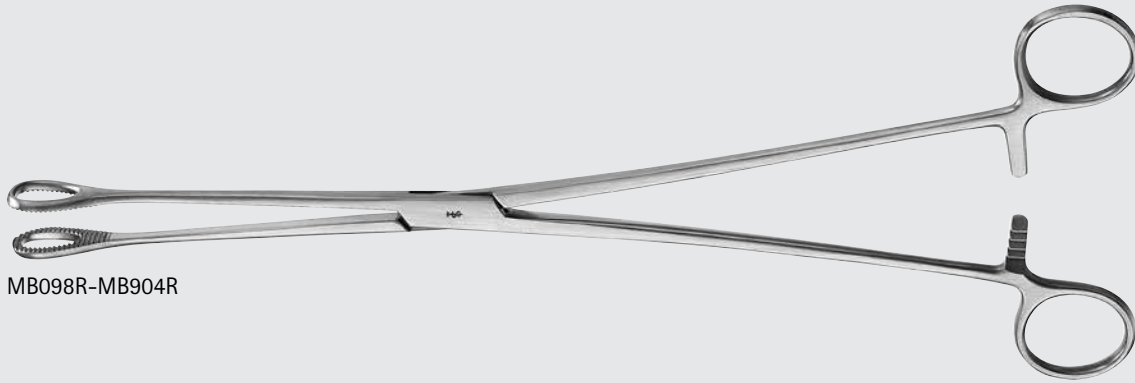

MB098R-MB904R



MB098R



MB099R



MB904R

FOERSTER-BALLENGER Sponge Forceps

Catalog Number	Tip	Jaw	Length (in.)
BF112R	SERR	STR	7
BF120R	SMOOTH	STR	9 5/8
BF122R	SERR	STR	9 5/8
BF113R	SERR	CVD	7
BF121R	SMOOTH	CVD	9 5/8
BF123R	SERR	CVD	9 5/8

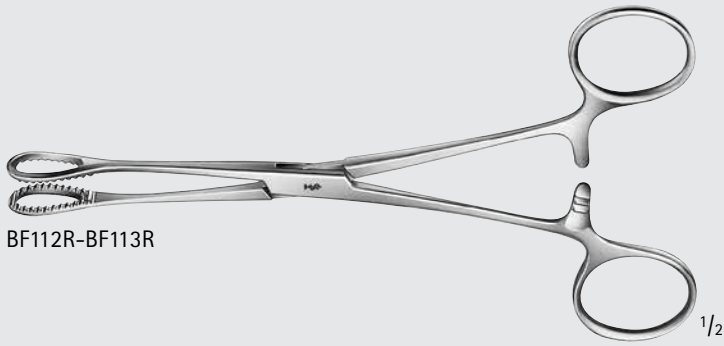

BF112R-BF113R

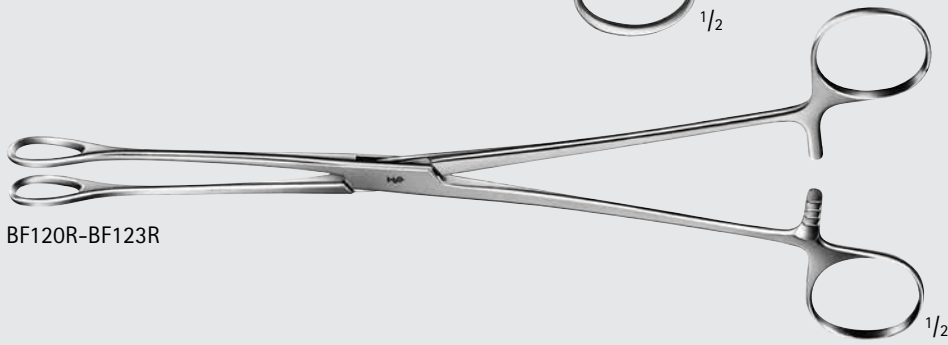

BF120R-BF123R

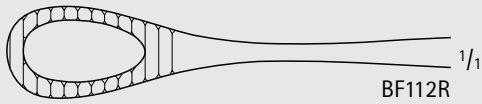

BF112R

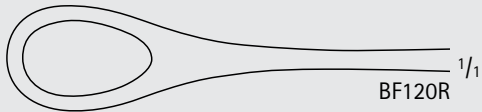

BF120R

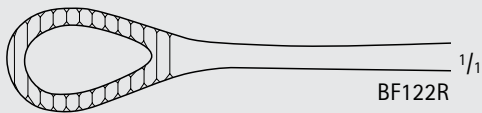

BF122R

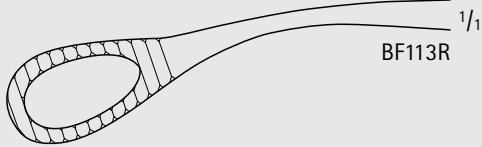

BF113R

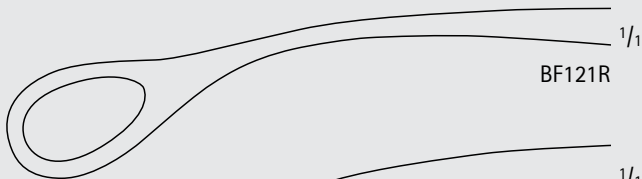

BF121R

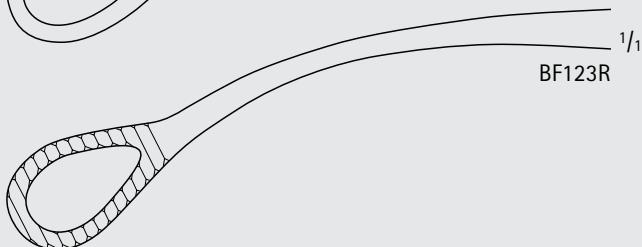

BF123R



INCHES

# General Surgery

## Dressing and Sponge Forceps

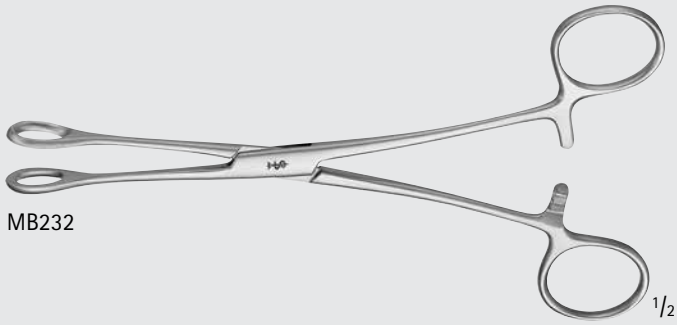

MB232

### BALLENGER Sponge Forceps

Catalog Number	Tip	Jaw	Length (in.)
MB232	SMOOTH	STR	7

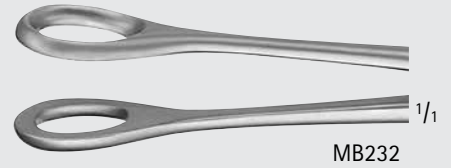

MB232

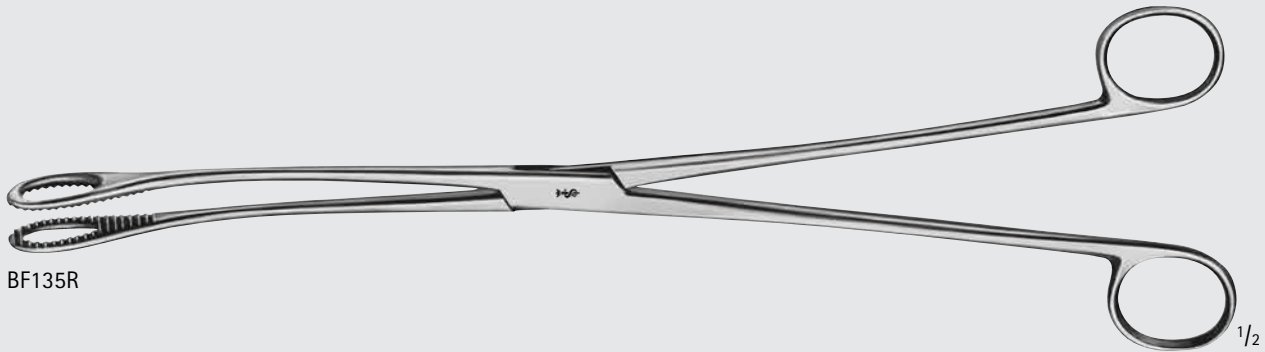

BF135R

### KELLY Sponge Forceps

Catalog Number	Tip	Jaw	Handle	Length (in.)
BF135R	SERR	CVD	W/ OUT RATCHET	12 1/2
BF136R	SERR	CVD	W/ RATCHET	12 1/2

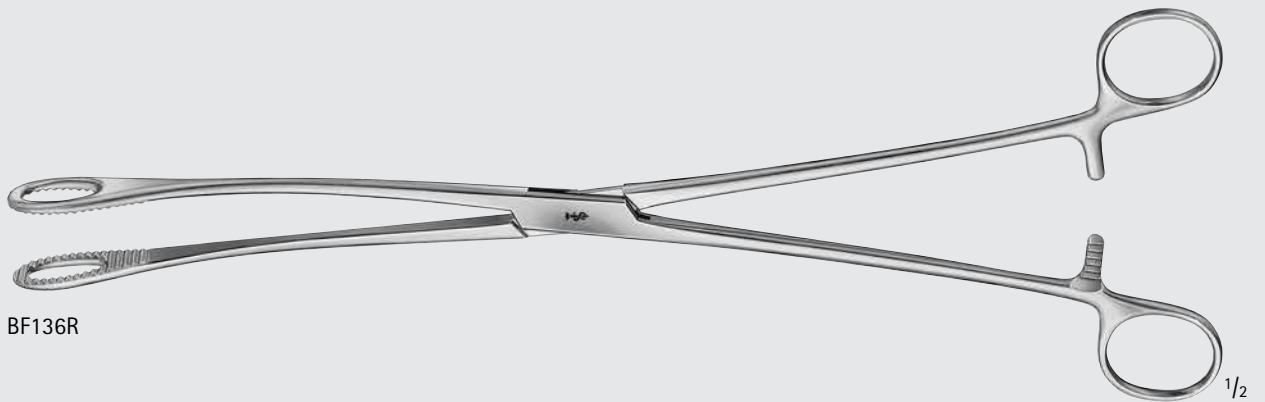

BF136R

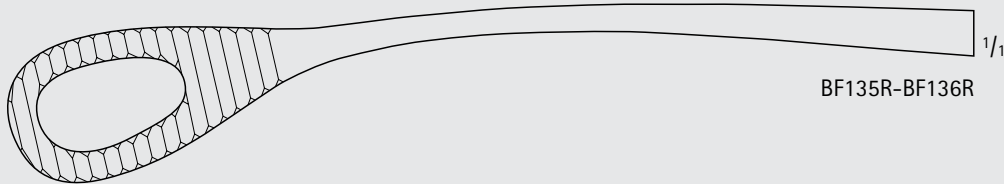

BF135R-BF136R

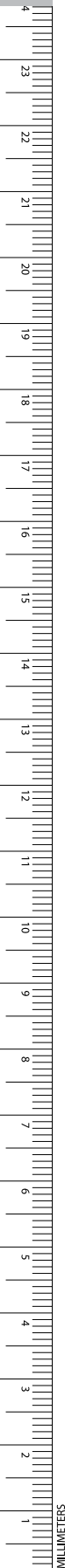

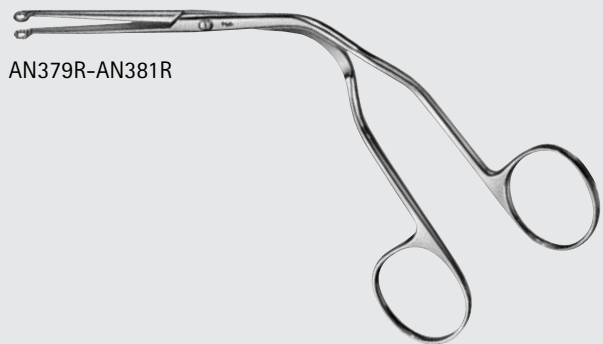

AN379R-AN381R

MAGILL Forceps

Catalog Number	Size	Length (in.)
AN379R	INFANT	6
AN380R	PEDIATRIC	7 7/8
AN381R	ADULT	9 3/4



AN379R

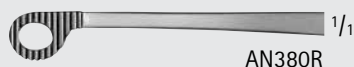

AN380R



AN381R

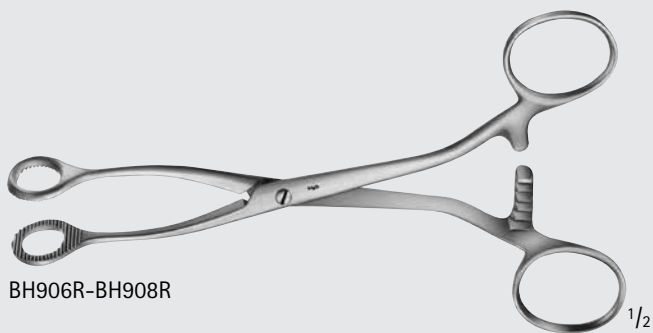

BH906R-BH908R

COLLIN Forceps W/ Ratchet

Catalog Number	Jaw	Length (in.)
BH906R	OVAL	6 1/4
BH908R	TEARDROP	6 1/4

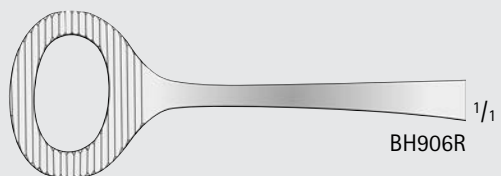

BH906R

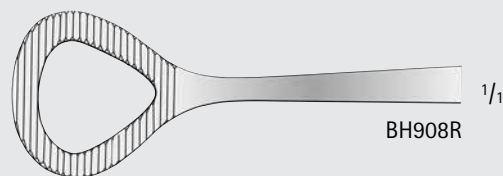

BH908R

# General Surgery

## Tongue Forceps

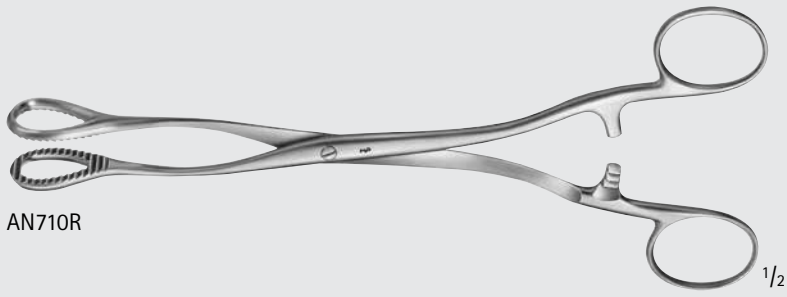

AN710R

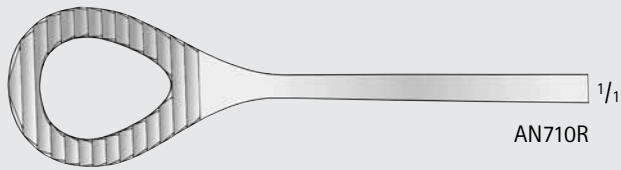

AN710R

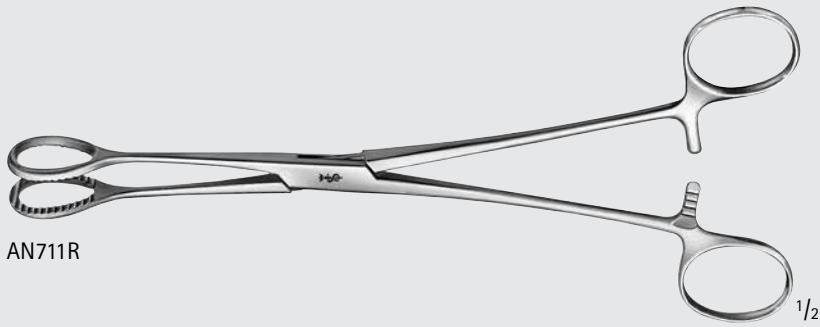

AN711R

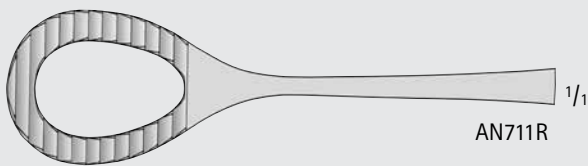

AN711R

### HEYWOOD-SMITH Forceps

Catalog Number	Tip	Length (in.)
AN710R	SERR	7 7/8
AN711R	SERR	8 1/4

YEOMAN Rectal Biopsy Forceps

Catalog Number	Tip Size (mm)	Shaft Length (in.)
EA903R	4	16 1/2

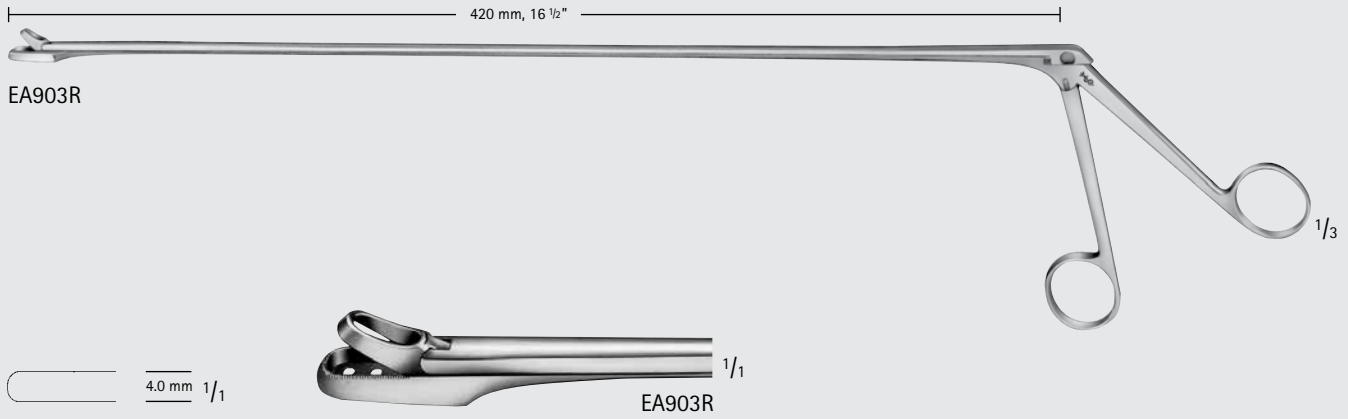

# General Surgery

## Biopsy Forceps

### AESCULAP Rectal Swab Holder

Catalog Number	Shaft Length (in.)
EA943R	15 3/4

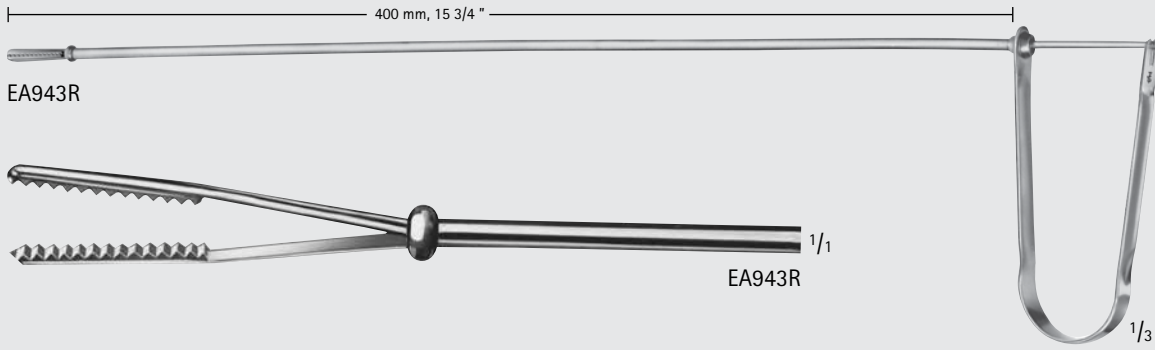

EA943R

EA943R

1/3

400 mm, 15 3/4 "

1/1

### PRICE Muscle Biopsy Clamp

Catalog Number	Jaw	Jaw Size (mm)	Length (in.)
MB200R	DOUBLE-PRONG	8	4
MG098R	DOUBLE-PRONG	15	4 3/8



MB200R

1/2



MG098R

1/2

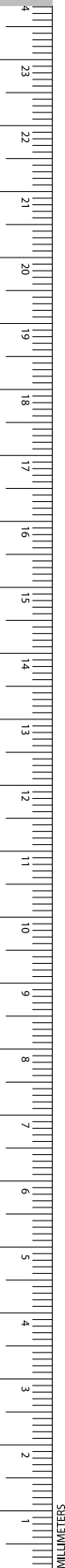

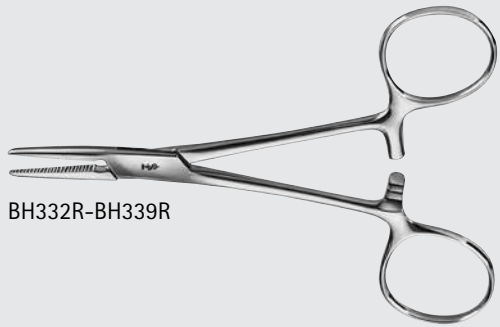

BH332R-BH339R

SPENCER-WELLS Forceps

Catalog Number	Jaw	Length (in.)
BH332R	STR	5 1/8
BH334R	STR	6
BH336R	STR	6 7/8
BH338R	STR	7 7/8
BH333R	CVD	5 1/8
BH335R	CVD	6
BH337R	CVD	6 7/8
BH339R	CVD	7 7/8



BH332R



BH333R



BH334R

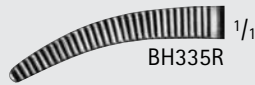

BH335R



BH336R



BH337R



BH338R



BH339R

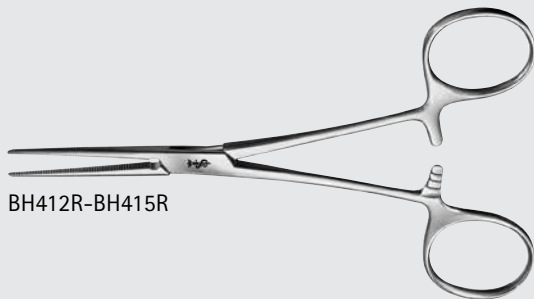

BH412R-BH415R

PEAN Forceps, Delicate

Catalog Number	Jaw	Length (in.)
BH412R	STR	5 1/8
BH414R	STR	5 1/2
BH413R	CVD	5 1/8
BH415R	CVD	5 1/2



BH412R



BH413R



BH414R



BH415R



INCHES

# General Surgery

## Hemostatic Forceps and Clamps

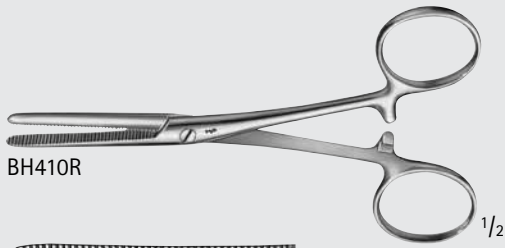

BH410R

1/2



1/1

BH410R

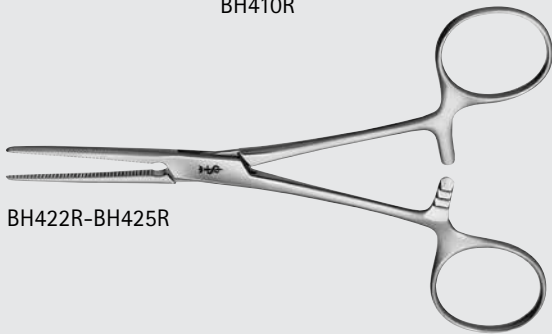

BH422R-BH425R



1/1

BH422R



1/1

BH424R



1/1

BH425R

### PEAN Forceps

Catalog Number	Jaw	Length (in.)
BH410R	STR	5
BH422R	STR	5 1/8
BH424R	STR	5 1/2
BH425R	CVD	5 1/2

### PEAN Artery Forceps

Catalog Number	Jaw	Length (in.)
MB180R	CVD	12
MB181R	CVD	14

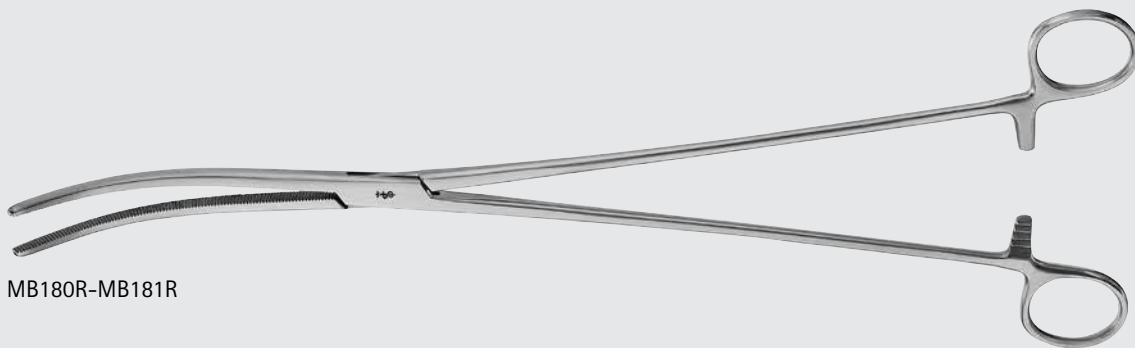

MB180R-MB181R

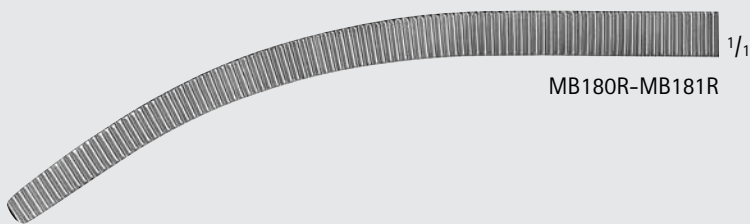

1/1

MB180R-MB181R

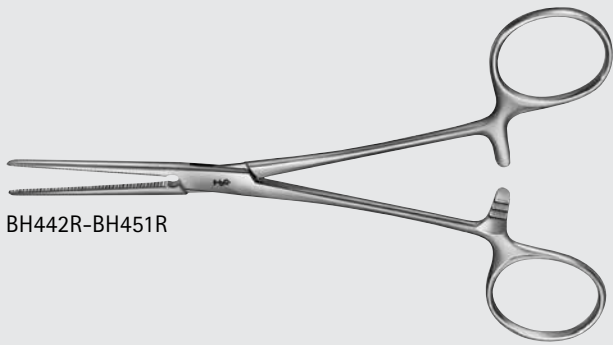

BH442R-BH451R

ROCHESTER-PEAN Forceps

Catalog Number	Jaw	Length (in.)
BH442R	STR	6 1/4
BH444R	STR	7 1/4
BH446R	STR	7 7/8
BH448R	STR	8 7/8
BH450R	STR	9 1/2
BH443R	CVD	6 1/4
BH445R	CVD	7 1/4
BH447R	CVD	7 7/8
BH449R	CVD	8 7/8
BH451R	CVD	9 1/2



BH442R



BH444R



BH446R



BH448R



BH450R



BH443R



BH445R



BH447R



BH449R

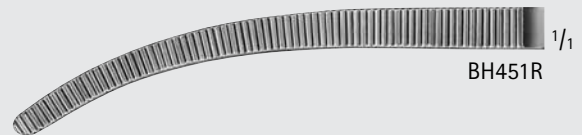

BH451R



INCHES

# General Surgery

## Hemostatic Forceps and Clamps

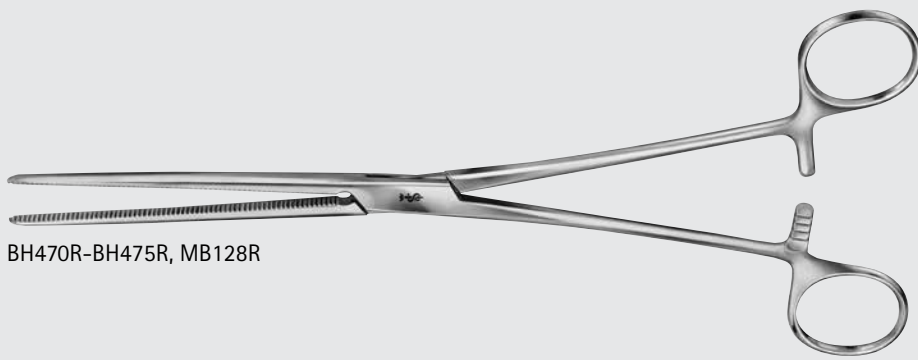

BH470R-BH475R, MB128R

PEAN Forceps, Long

Catalog Number	Jaw	Length (in.)
BH470R	STR	9 1/2
BH472R	STR	10 1/4
BH474R	STR	11
MB128R	STR	12
BH471R	CVD	9 1/2
BH473R	CVD	10 1/4
BH475R	CVD	11



BH470R



BH472R



BH474R



MB128R



BH471R



BH473R

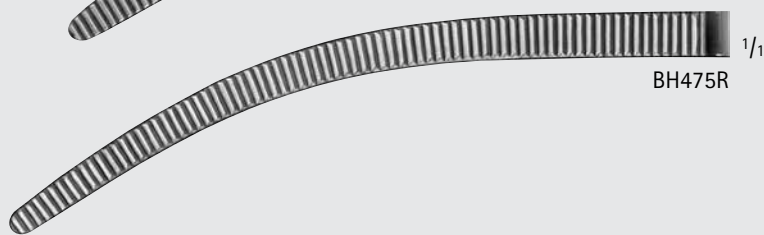

BH475R

KOCHER Forceps, Delicate

Catalog Number	Jaw	Teeth	Length (in.)
BH614R	STR	1 x 2	5 1/2
BH615R	CVD	1 x 2	5 1/2



BH614R-BH615R

1/2



BH614R

1/1



BH615R

1/1

KOCHER Forceps

Catalog Number	Jaw	Teeth	Length (in.)
BH630R	STR	1 x 2	6
BH631R	CVD	1 x 2	6

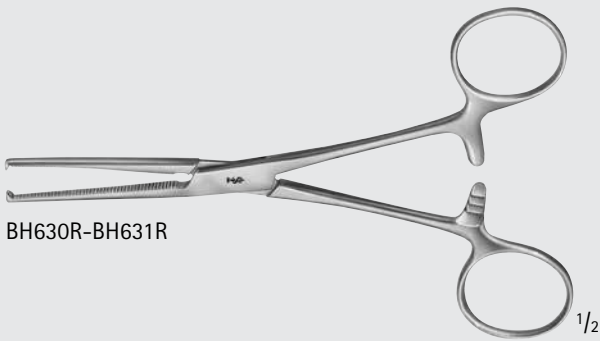

BH630R-BH631R

1/2



BH630R

1/1



BH631R

1/1

# General Surgery

## Hemostatic Forceps and Clamps

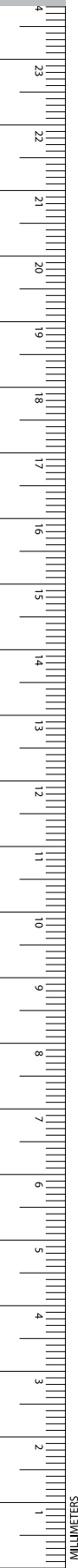

BH618R-BH619R  $\frac{1}{2}$

BH618R  $\frac{1}{1}$

BH619R  $\frac{1}{1}$

Catalog Number	Jaw	Teeth	Length (in.)
BH618R	STR	1 x 2	5 1/2
BH619R	CVD	1 x 2	5 1/2

MB172R  $\frac{1}{2}$

MB172R  $\frac{1}{1}$

Catalog Number	Jaw	Teeth	Length (in.)
MB172R	STR	1 x 2	14

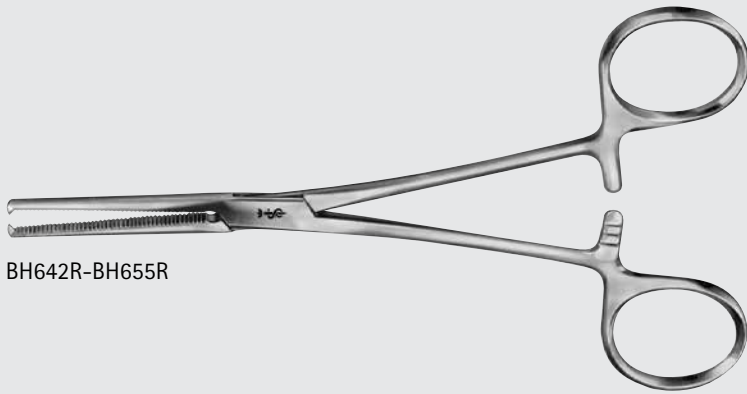

BH642R-BH655R

KOCHER-OCHSNER Forceps

Catalog Number	Jaw	Teeth	Length (in.)
BH642R	STR	1 x 2	6 1/4
BH644R	STR	1 x 2	7 1/4
BH646R	STR	1 x 2	7 7/8
BH648R	STR	1 x 2	8 7/8
BH650R	STR	1 x 2	9 1/2
BH652R	STR	1 x 2	10 1/4
BH654R	STR	1 x 2	11
BH643R	CVD	1 x 2	6 1/4
BH645R	CVD	1 x 2	7 1/4
BH647R	CVD	1 x 2	7 7/8
BH649R	CVD	1 x 2	8 7/8
BH651R	CVD	1 x 2	9 1/2
BH653R	CVD	1 x 2	10 1/4
BH655R	CVD	1 x 2	11



BH642R



BH644R



BH646R



BH648R



BH650R



BH652R



BH654R



BH643R



BH645R



BH647R

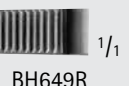

BH649R



BH651R



BH653R



BH655R



INCHES

# General Surgery

## Hemostatic Forceps and Clamps

### ROCHESTER-OCHSNER Forceps

Catalog Number	Jaw	Teeth	Length (in.)
MB807R	STR	1 x 2	14
MB909R	STR	1 x 2	16
MB908R	CVD	1 x 2	13 3/4



MB807R, MB909R



MB807R

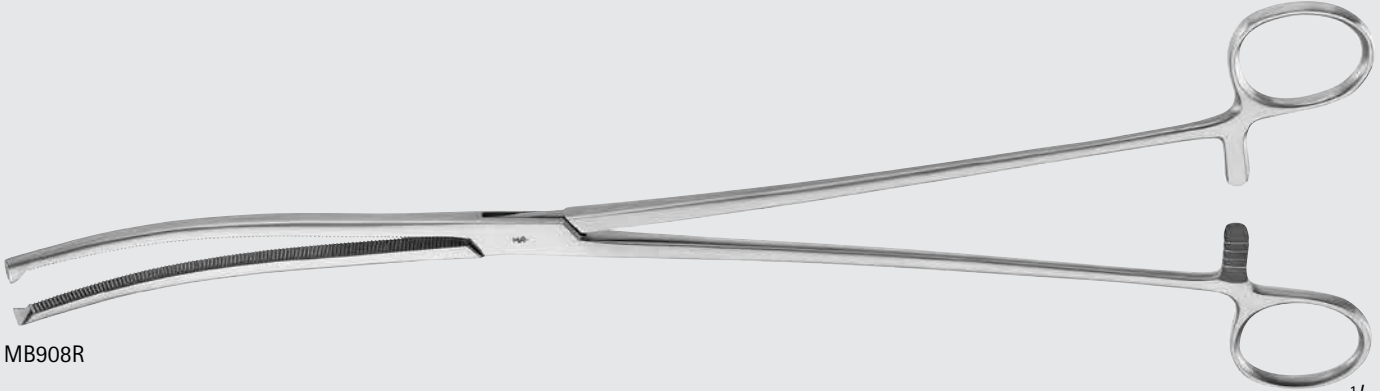

MB908R



MB908R

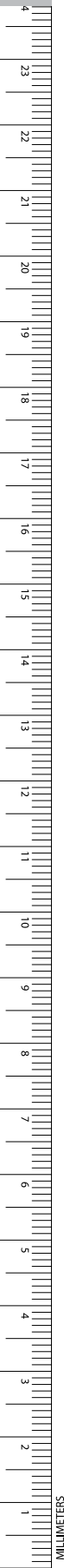

ROCHESTER-CARMALT Forceps

Catalog Number	Jaw	Length (in.)
BH800R	STR	6 1/4
BH804R	STR	7 7/8
MG196R	STR	9
MG431R	STR	10 1/4
BH801R	CVD	6 1/4
BH805R	CVD	7 7/8
MG197R	CVD	9
MG432R	CVD	10 1/4

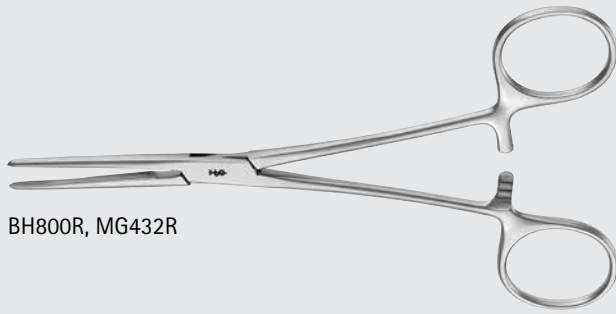

BH800R, MG432R



BH800R 1/1



BH804R 1/1



MG196R 1/1



MG431R 1/1



BH801R 1/1



BH805R 1/1



MG197R 1/1



MG432R 1/1

STOREY Forceps

Catalog Number	Tip	Length (in.)
MG353R	STRONG-CVD	8 3/4
MG354R	RIGHT-ANG	8 3/4

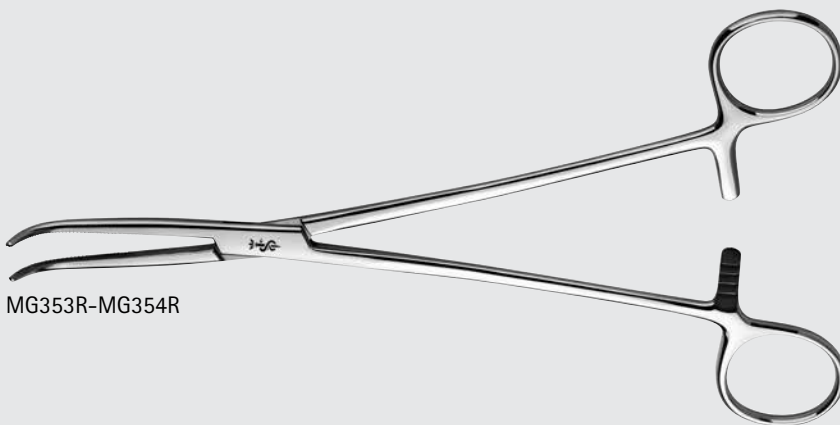

MG353R-MG354R 1/2



MG353R 1/1



MG354R 1/1



INCHES

# General Surgery

## Hemostatic Forceps and Clamps



MG426R  $\frac{1}{2}$

MG426R  $\frac{1}{1}$

**JONES Hemostatic Forceps**

Catalog Number	Jaw	Length (in.)
MG426R	STR	5

BH831R-BH833R

BH831R  $\frac{1}{1}$

BH833R  $\frac{1}{1}$

**MOYNIHAN Forceps**

Catalog Number	Jaw	Length (in.)
BH831R	CVD	9
BH833R	CVD	9 1/2

BH951R-BH952R  $\frac{1}{2}$

BH951R  $\frac{1}{1}$

BH952R  $\frac{1}{1}$

**NEGUS Tonsil Forceps**

Catalog Number	Jaw	Length (in.)
BH951R	HEAVY-CVD	7 1/2
BH952R	U-CVD	7 1/2

**CARMALT Artery Forceps, Longitudinal Serrations**

Catalog Number	Jaw	Length (in.)
MB182R	SLIGHT-CVD	12

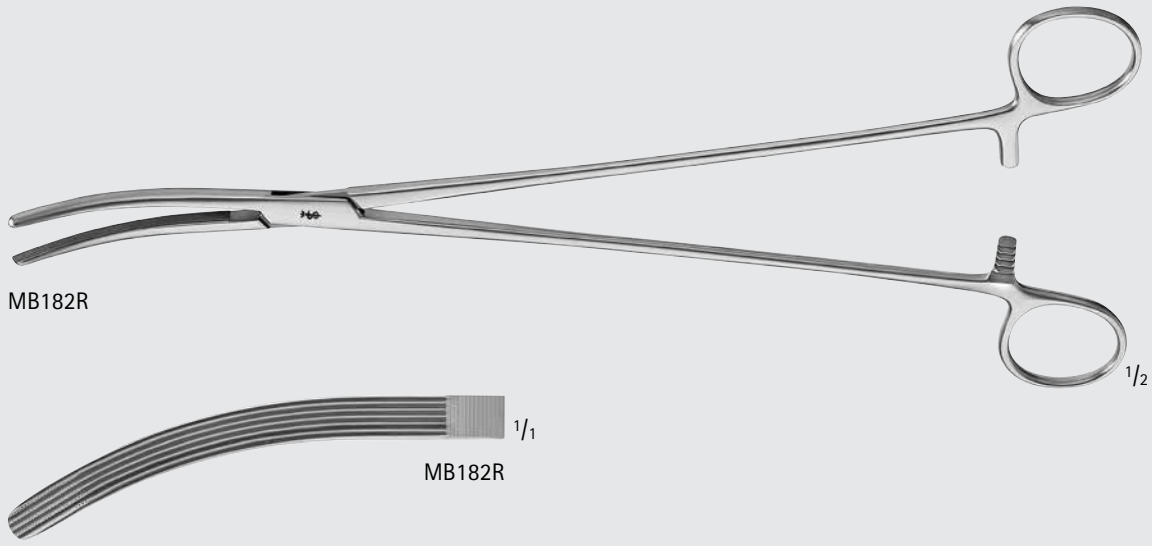

**SCHNIDT Tonsil Clamp**

Catalog Number	Ring Handle	Jaw	Length (in.)
MA172R	OPEN RING	STR	7 1/2
BH961R	OPEN-RING	SLIGHT-CVD	7 1/4
BH963R	OPEN-RING	CVD	7 1/4
BH957R	CLOSED-RING	SLIGHT-CVD	7 1/4
BH959R	CLOSED-RING	CVD	7 1/4

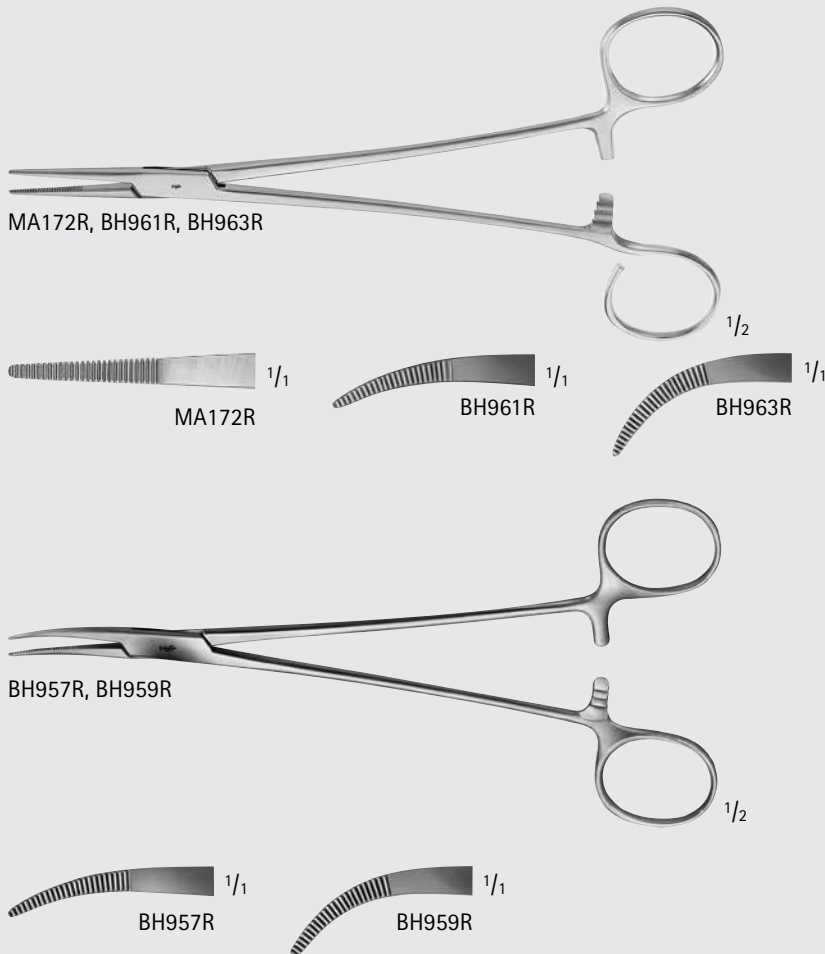

INCHES

# General Surgery

## Hemostatic Forceps and Clamps



MD450

MD450 1/1

1/2

**OCHSNER-DIXON Artery Forceps**

Catalog Number	Jaw	Teeth	Length (in.)
MD450	STR	1 x 2	6 1/4

BH104R-BH115R

BH104R 1/1

BH105R 1/1

BH114R 1/1

BH115R 1/1

1/2

**Baby HARTMANN Mosquito Artery Forceps**

Catalog Number	Jaw	Teeth	Length (in.)
BH104R	STR	-	4
BH114R	STR	1 x 2	4
BH105R	CVD	-	4
BH115R	CVD	1 x 2	4

BH108R-BH119R

BH108R 1/1

BH109R 1/1

BH118R 1/1

BH119R 1/1

1/2

**Micro HALSTED Mosquito Forceps, Delicate**

Catalog Number	Jaw	Teeth	Length (in.)
BH108R	STR	-	5
BH118R	STR	1 x 2	5
BH109R	CVD	-	5
BH119R	CVD	1 x 2	5

HALSTED Mosquito Forceps, Delicate

Catalog Number	Jaw	Teeth	Length (in.)
BH110R	STR	-	5
BH120R	STR	1 x 2	5
BH210R	STR	-	7 7/8
BH214R	STR	1 x 2	7 7/8
BH111R	CVD	-	5
BH121R	CVD	1 x 2	5
BH211R	CVD	-	7 7/8
BH215R	CVD	1 x 2	7 7/8

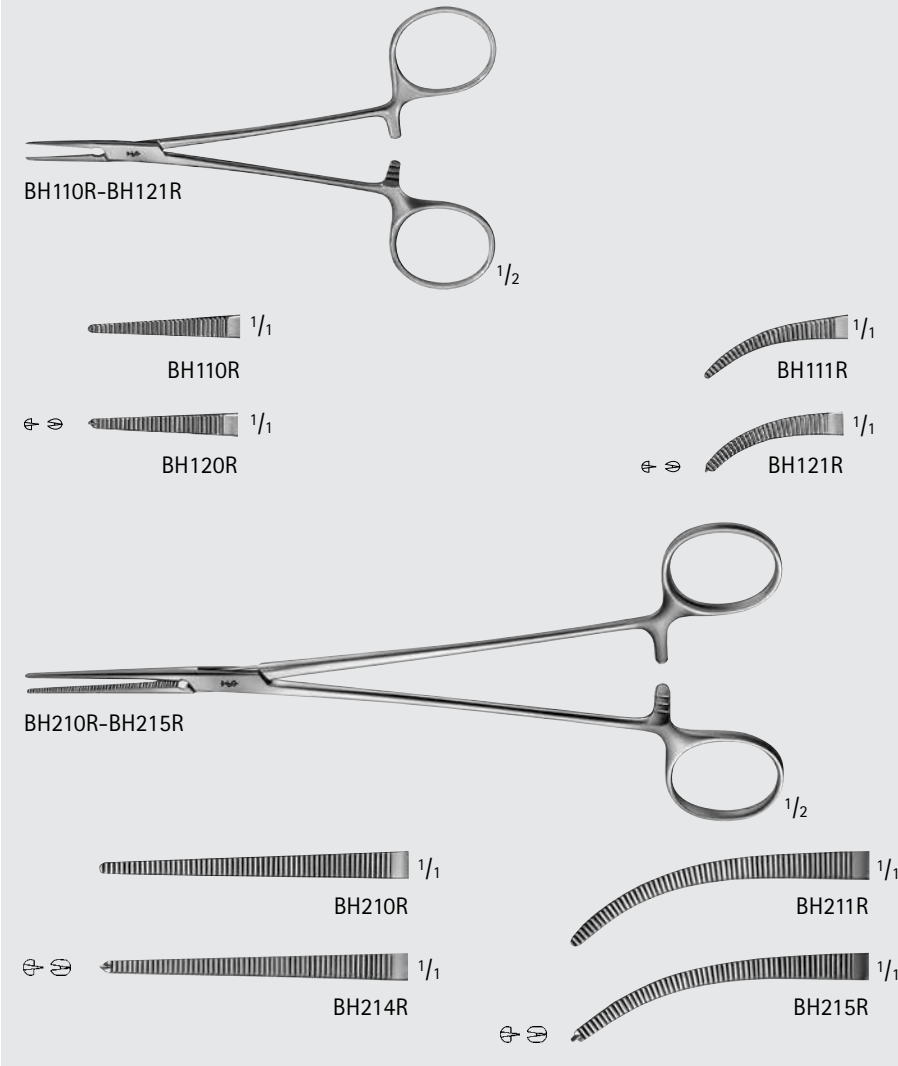

JACOBSON Mosquito Forceps

Catalog Number	Jaw	Length (in.)
BH106R	STR	5 1/8
MB229R	CVD	5

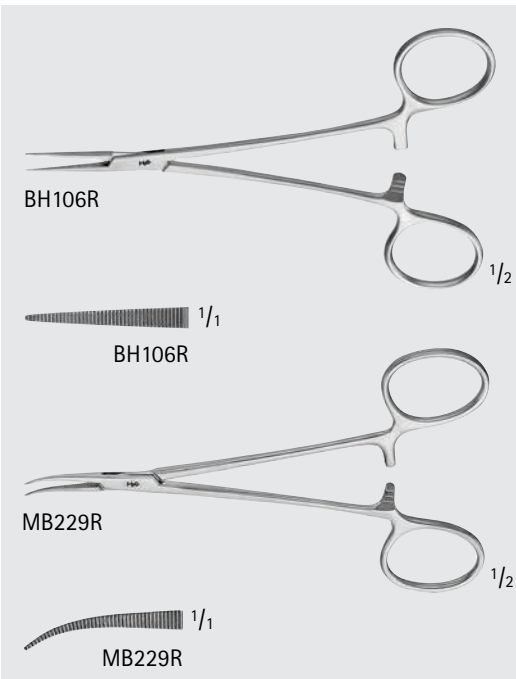

# General Surgery

## Hemostatic Forceps and Clamps



MG085R  $\frac{1}{2}$

MG085R  $\frac{1}{1}$

Catalog Number	Jaw	Length (in.)
MG085R	DEL, CVD.	6

BJ002R  $\frac{1}{2}$

BJ002R  $\frac{1}{1}$

Catalog Number	Tip	Jaw	Length (in.)
BJ002R	SMOOTH	STR	3 3/4

BH187R  $\frac{1}{2}$

BH187R  $\frac{1}{1}$

BH189R  $\frac{1}{2}$

BH189R  $\frac{1}{1}$

Catalog Number	Jaw	Length (in.)
BH187R	SLIGHT-CVD	7 1/2
BH189R	HEAVY-CVD	7 1/2

ADSON Hemostatic Forceps

Catalog Number	Jaw	Length (in.)
BH205R	CVD	8 1/2

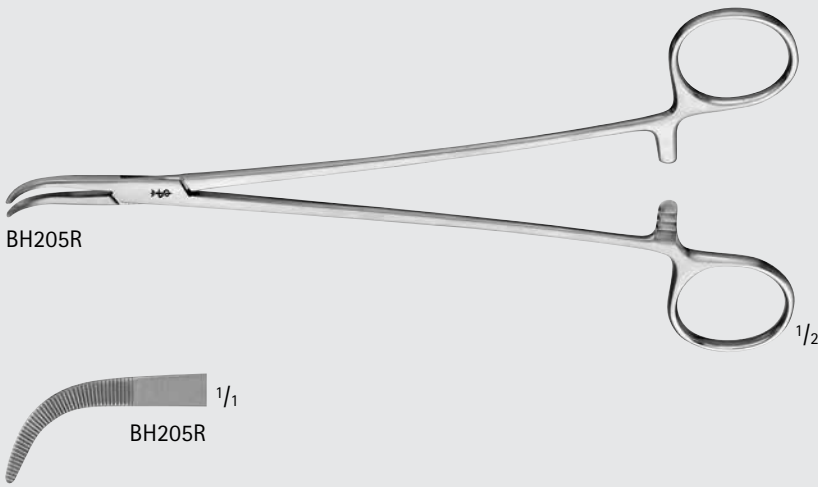

HALSTED Forceps Delicate

Catalog Number	Jaw	Teeth	Length (in.)
BH202R	STR	-	7 1/4
BH212R	STR	1 x 2	7 1/4
BH203R	CVD	-	7 1/4
BH213R	CVD	1 x 2	7 1/4

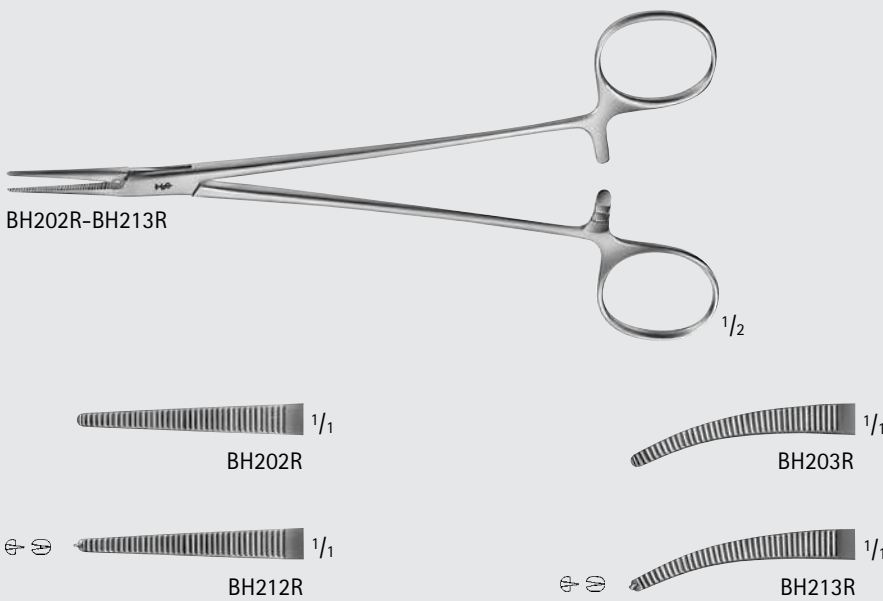

PROVIDENCE Hospital Forceps, Delicate

Catalog Number	Jaw	Length (in.)
BH130R	STR	5 1/2
BH131R	CVD	5 1/2

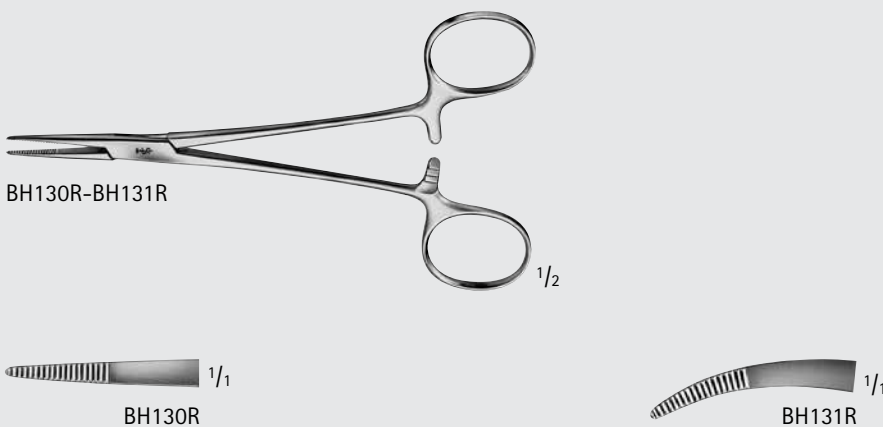

# General Surgery

## Hemostatic Forceps and Clamps



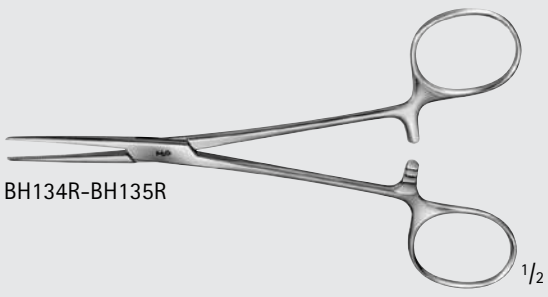

BH134R-BH135R 1/2



BH134R 1/1



BH135R 1/1

### KELLY Forceps

Catalog Number	Jaw	Length (in.)
BH134R	STR	5 1/2
BH135R	CVD	5 1/2

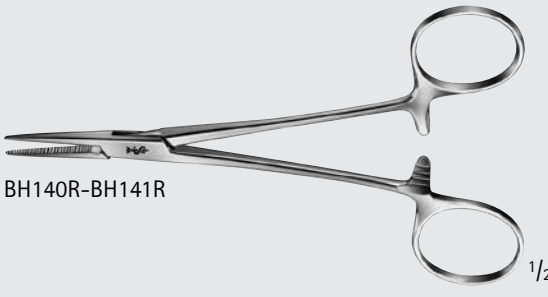

BH140R-BH141R 1/2



BH140R 1/1

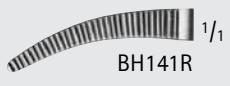

BH141R 1/1

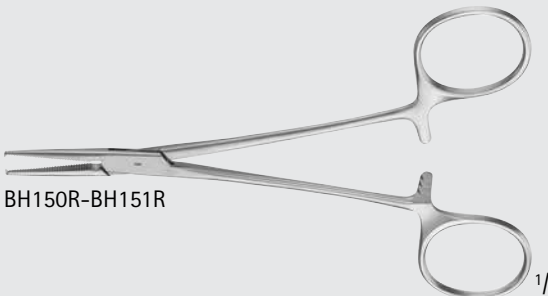

BH150R-BH151R 1/2



BH150R 1/1



BH151R 1/1

### Baby CRILE Forceps

Catalog Number	Jaw	Teeth	Length (in.)
BH140R	STR	-	5 1/2
BH150R	STR	1 x 2	5 1/2
BH141R	CVD	-	5 1/2
BH151R	CVD	1 x 2	5 1/2

CRILE Forceps

Catalog Number	Jaw	Teeth	Length (in.)
BH144R	STR	-	5 1/2
BH154R	STR	1 x 2	5 1/2
BH166R	STR	-	6 1/4
BH176R	STR	1 x 2	6 1/4
BH145R	CVD	-	5 1/2
BH155R	CVD	1 x 2	5 1/2
BH167R	CVD	-	6 1/4
BH177R	CVD	1 x 2	6 1/4

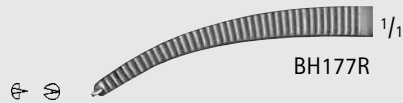
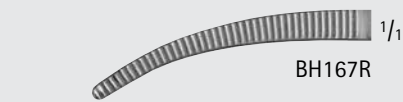
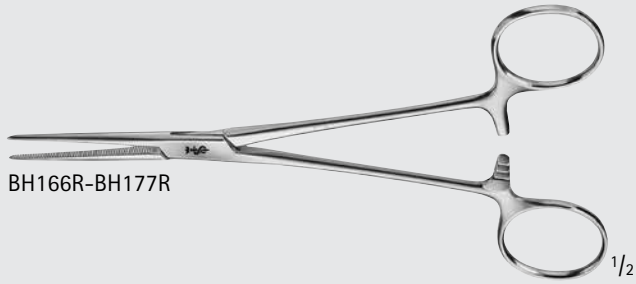

# General Surgery

## Hemostatic Forceps and Clamps

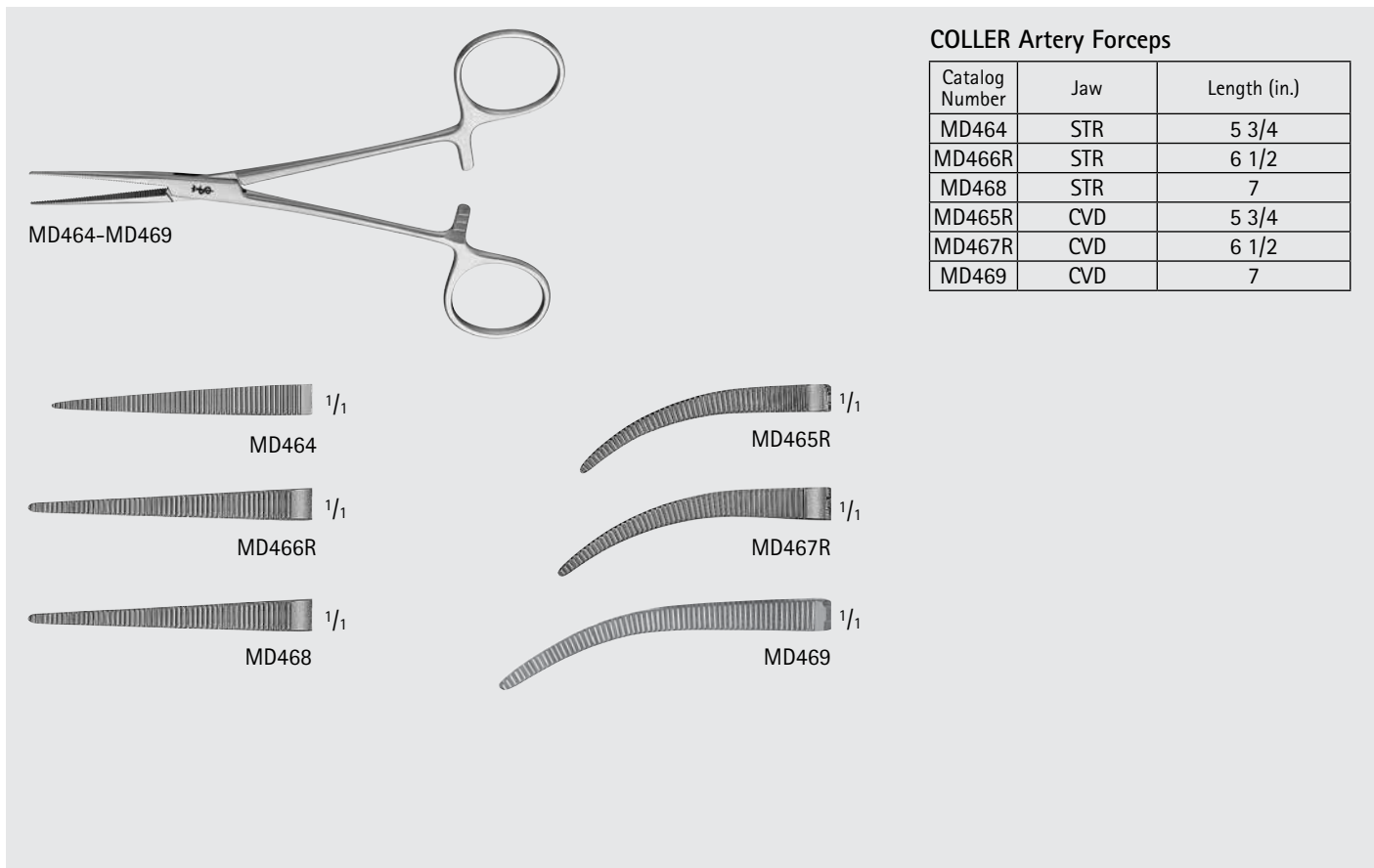

**COLLER Artery Forceps**

Catalog Number	Jaw	Length (in.)
MD464	STR	5 3/4
MD466R	STR	6 1/2
MD468	STR	7
MD465R	CVD	5 3/4
MD467R	CVD	6 1/2
MD469	CVD	7

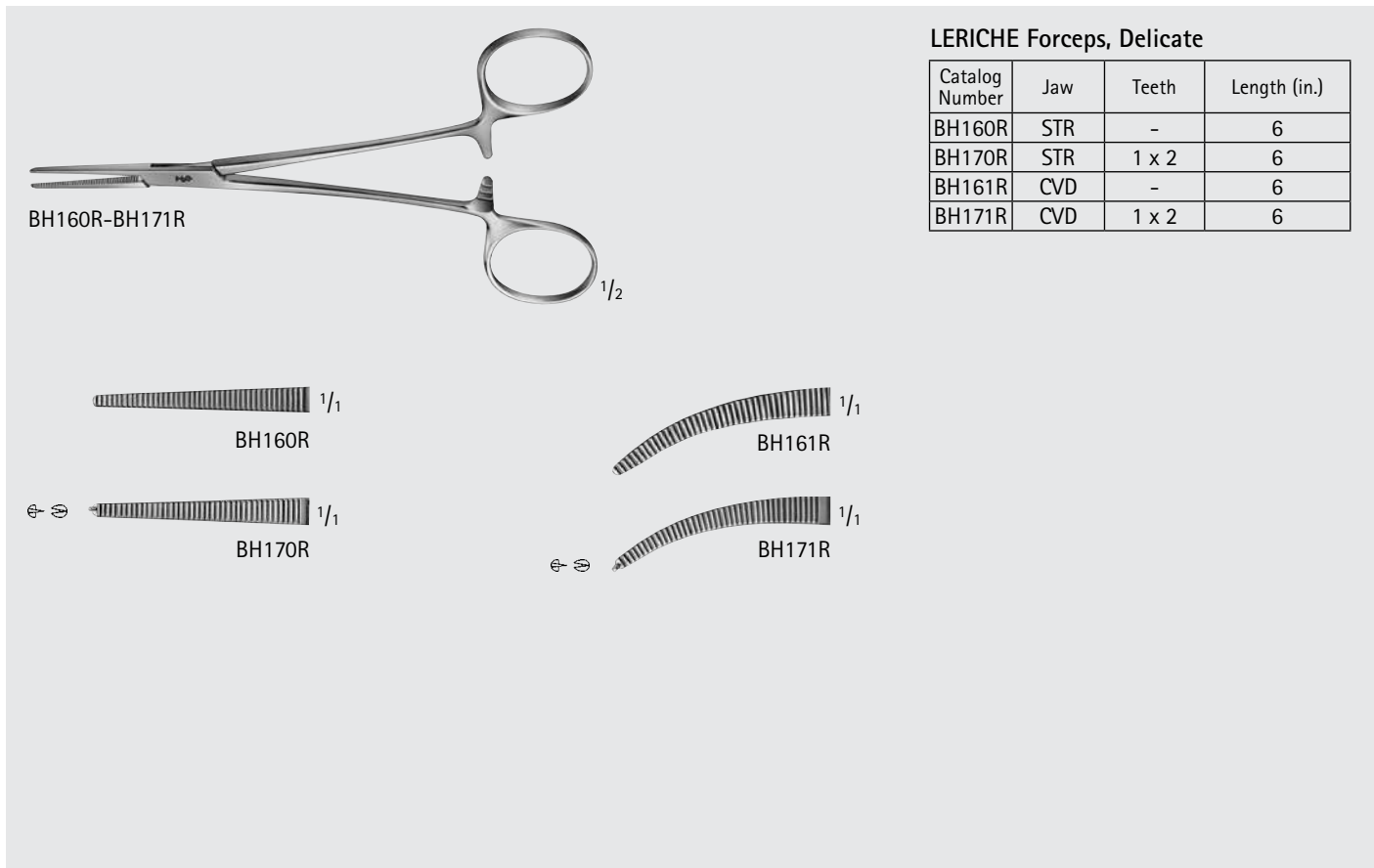

**LERICHE Forceps, Delicate**

Catalog Number	Jaw	Teeth	Length (in.)
BH160R	STR	-	6
BH170R	STR	1 x 2	6
BH161R	CVD	-	6
BH171R	CVD	1 x 2	6

**RANKIN Forceps, Delicate**

Catalog Number	Jaw	Length (in.)
BH164R	STR	6 1/4
BH165R	CVD	6 1/4

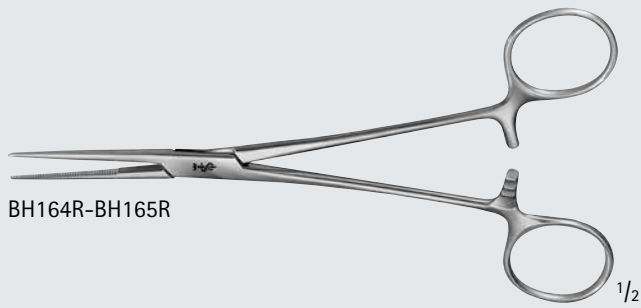

**BIRKETT Hemostatic Forceps**

Catalog Number	Jaw	Length (in.)
BH197R	CVD	7 1/4

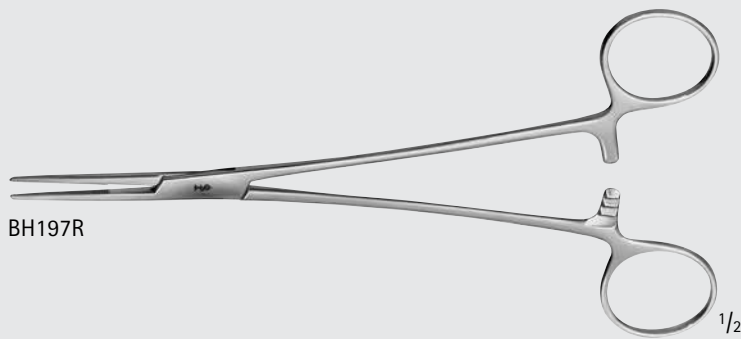

**NISSEN Tonsil Forceps, Delicate**

Catalog Number	Jaw	Length (in.)
BH199R	CVD	7 1/4

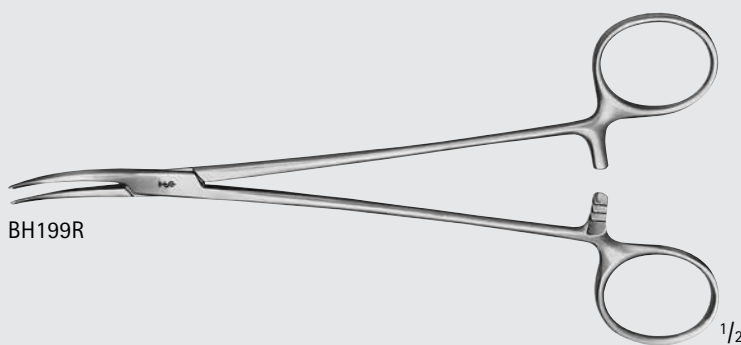

# General Surgery

## Hemostatic Forceps and Clamps

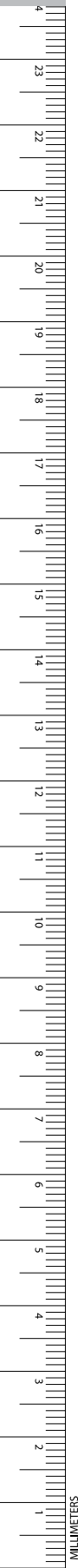

BH200R-BH201R

BH200R 1/1

BH201R 1/1

1/2

**ADSON Tonsil Forceps, Delicate**

Catalog Number	Jaw	Length (in.)
BH200R	STR	7 1/4
BH201R	CVD	7 1/4

BH206R-BH217R

BH206R 1/1

BH207R 1/1

BH216R 1/1

BH217R 1/1

BH209R 1/1

**HEISS Forceps, Delicate**

Catalog Number	Jaw	Teeth	Length (in.)
BH206R	STR	-	7 7/8
BH216R	STR	1 x 2	7 7/8
BH207R	CVD	-	7 7/8
BH217R	CVD	1 x 2	7 7/8
BH209R	HVY-CVD	-	7 3/4

**BENGOLEA Forceps, Delicate**

Catalog Number	Jaw	Length (in.)
BH228R	STR	9 5/8
BH229R	CVD	9 5/8

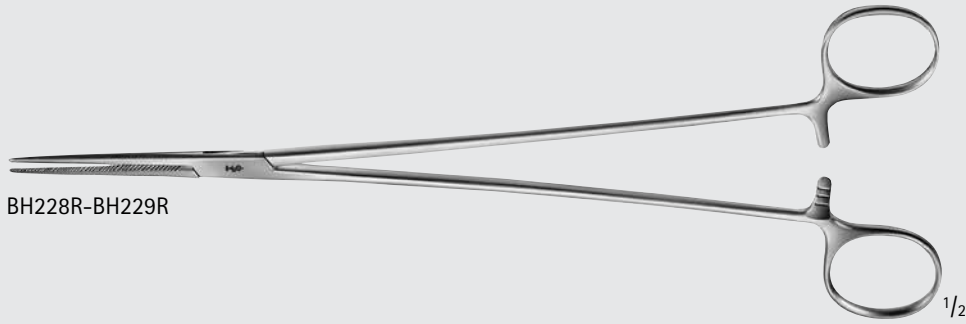

**BRIDGE Forceps, Delicate**

Catalog Number	Jaw	Length (in.)
BH230R	STR	10 3/4
BH231R	CVD	10 3/4

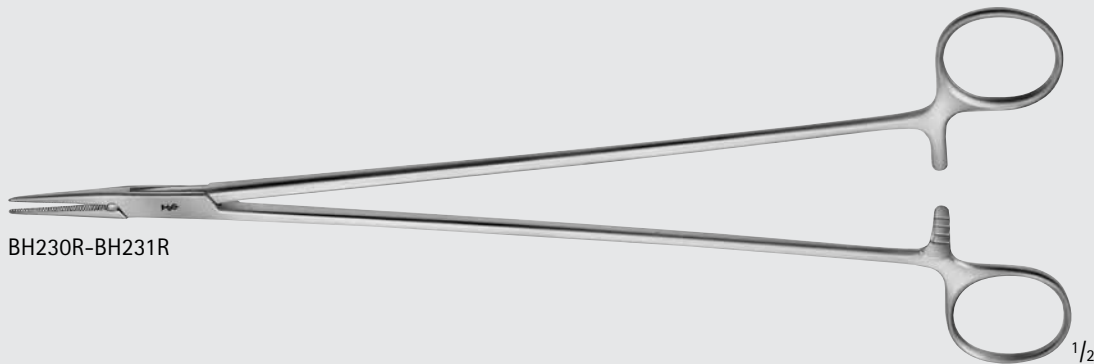

# General Surgery

## Dissecting and Right Angle Forceps

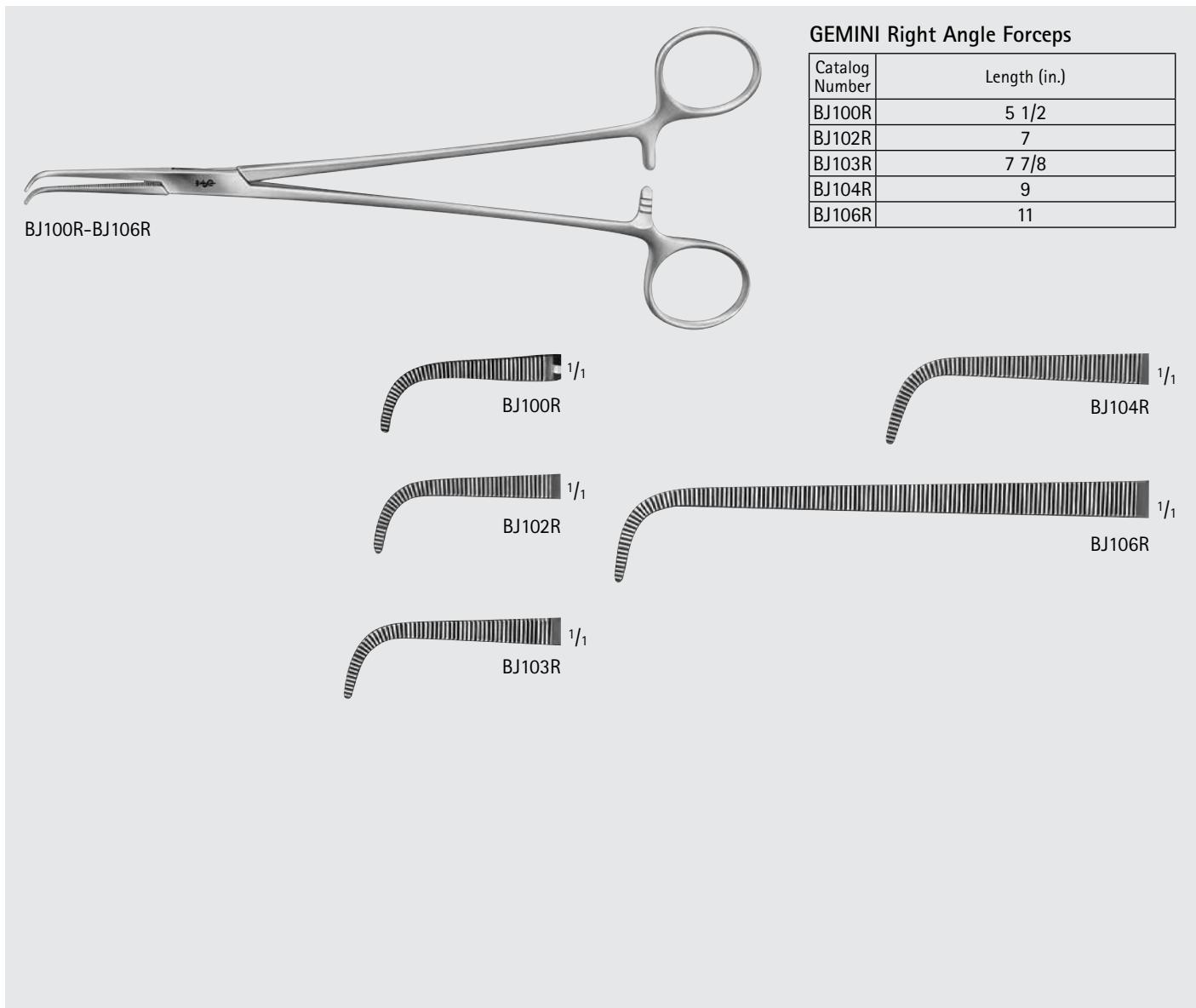

### GEMINI Right Angle Forceps

Catalog Number	Length (in.)
BJ100R	5 1/2
BJ102R	7
BJ103R	7 7/8
BJ104R	9
BJ106R	11

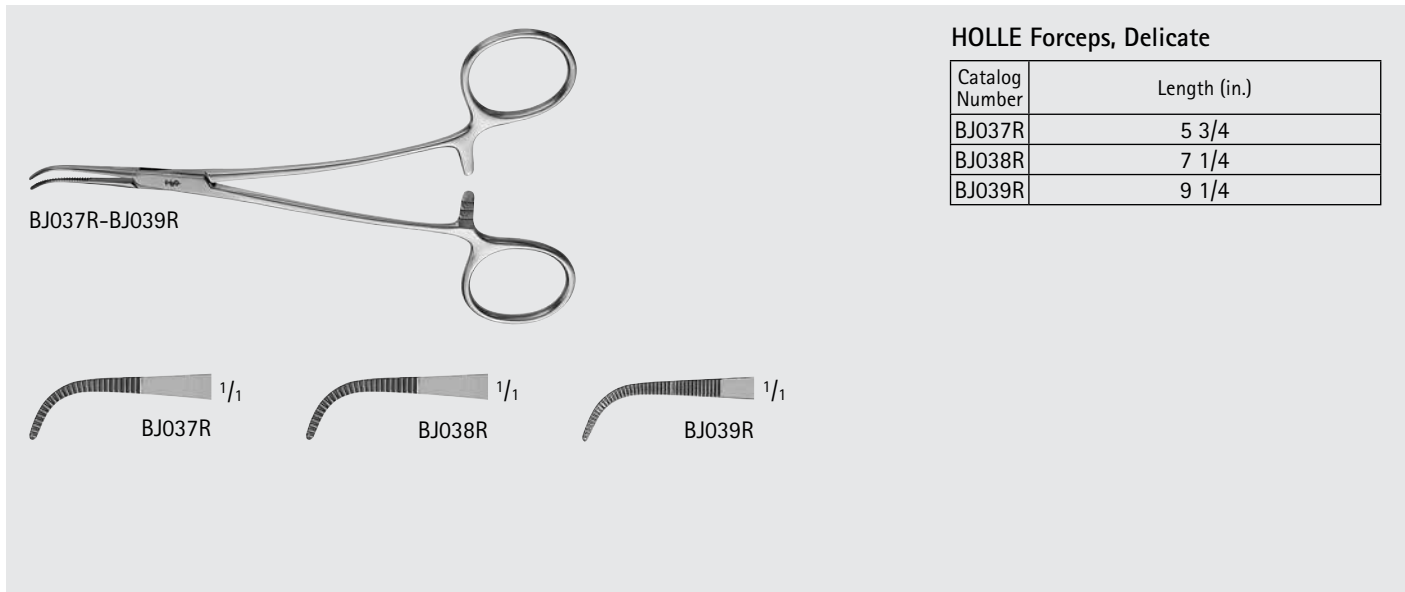

### HOLLE Forceps, Delicate

Catalog Number	Length (in.)
BJ037R	5 3/4
BJ038R	7 1/4
BJ039R	9 1/4

# General Surgery

## Dissecting and Right Angle Forceps

### KANTROWITZ Right Angle Forceps

Catalog Number	Length (in.)
MB058R	6 3/8
BJ057R	7 7/8
BJ058R	9 5/8
BJ059R	10 3/4
MB061R	12

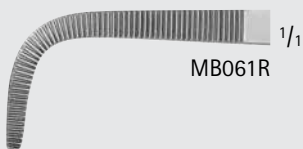
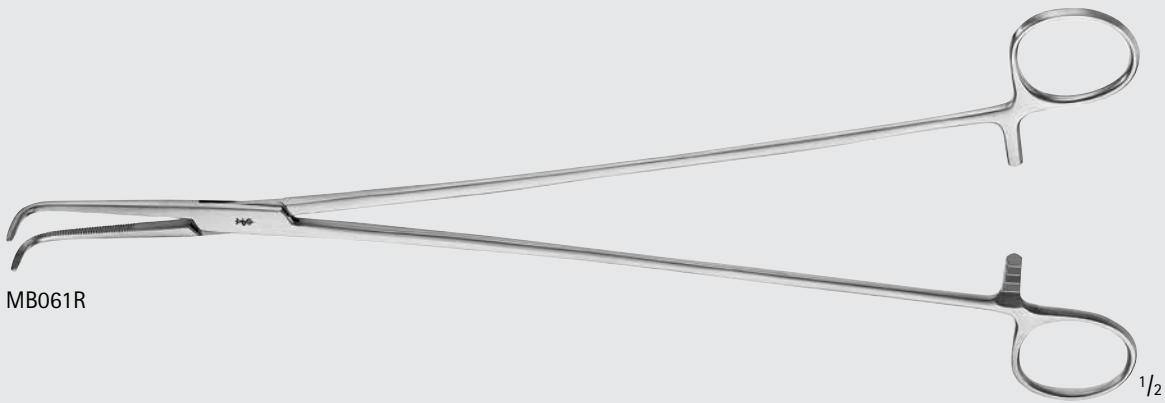
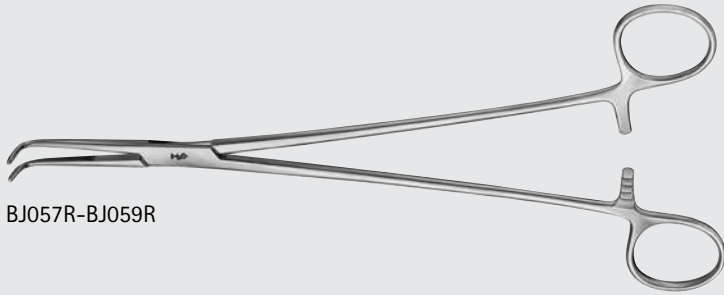
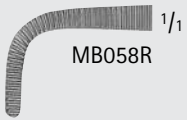
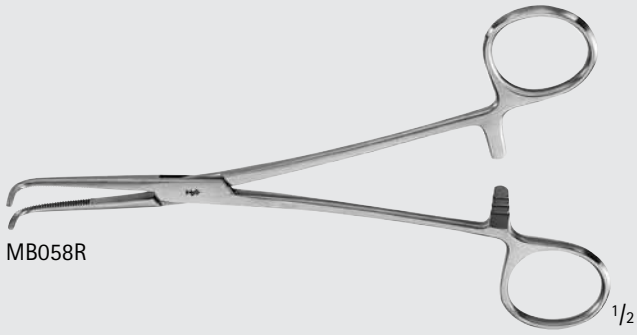

# General Surgery

## Dissecting and Right Angle Forceps



BJ013R-BJ014R

BJ013R  $\frac{1}{1}$

BJ014R  $\frac{1}{1}$

**Baby ADSON Forceps**

Catalog Number	Length (in.)
BJ013R	5 1/2
BJ014R	7

BJ008R

BJ008R  $\frac{1}{1}$

**Micro ADSON Suture Forceps**

Catalog Number	Length (in.)
BJ008R	5 1/2

MD569-MD570R

MD569  $\frac{1}{1}$

MD570R  $\frac{1}{1}$

**MIXTER (MEEKER) Right Angle Forceps**

Catalog Number	Length (in.)
MD569	5 1/2
MD570R	7

OVERHOLT-GEISSENDOERFER Forceps

Catalog Number	Jaw Curve (#)	Length (in.)
BJ020R	0	7 3/4
BJ021R	1	8
BJ022R	2	8 3/4
BJ023R	3	8 7/8
BJ024R	4	8 3/4
BJ025R	5	9
BJ026R	6	8 7/8
BJ031R	1	10 1/4
BJ032R	2	10 5/8
BJ033R	3	10 3/4
BJ034R	4	10 5/8
BJ035R	5	11



BJ020R-BJ035R



BJ020R

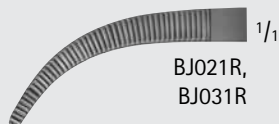

BJ021R,  
BJ031R

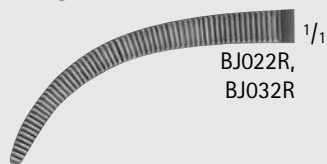

BJ022R,  
BJ032R

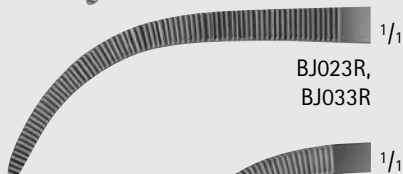

BJ023R,  
BJ033R

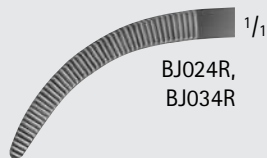

BJ024R,  
BJ034R

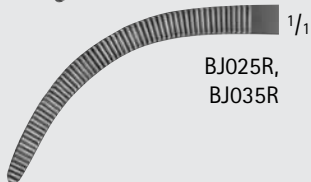

BJ025R,  
BJ035R



BJ026R

# General Surgery

## Dissecting and Right Angle Forceps

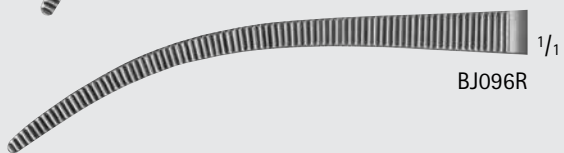
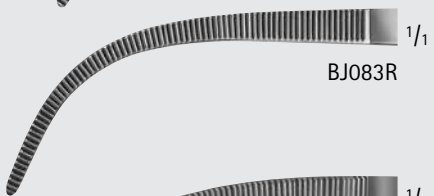
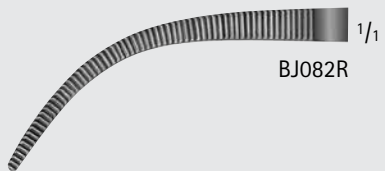
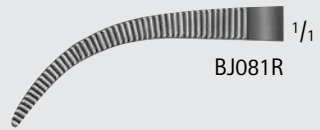
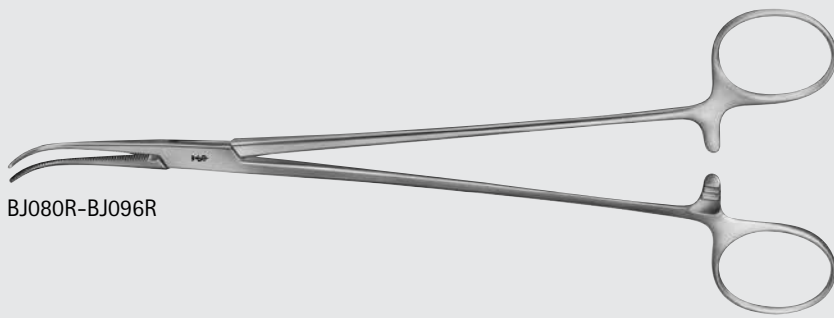

### OVERHOLT Forceps

Catalog Number	Jaw Curve (#)	Length (in.)
BJ080R	0	8 1/2
BJ081R	1	8 1/4
BJ082R	2	8 3/4
BJ083R	3	8 7/8
BJ086R	6	8 7/8
BJ090R	0	11 5/8
BJ091R	1	11 5/8
BJ096R	6	11 3/4



# General Surgery

## Dissecting and Right Angle Forceps

### MEEKER Forceps

Catalog Number	Length (in.)
MB459R	11

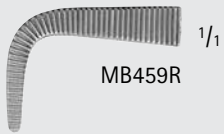
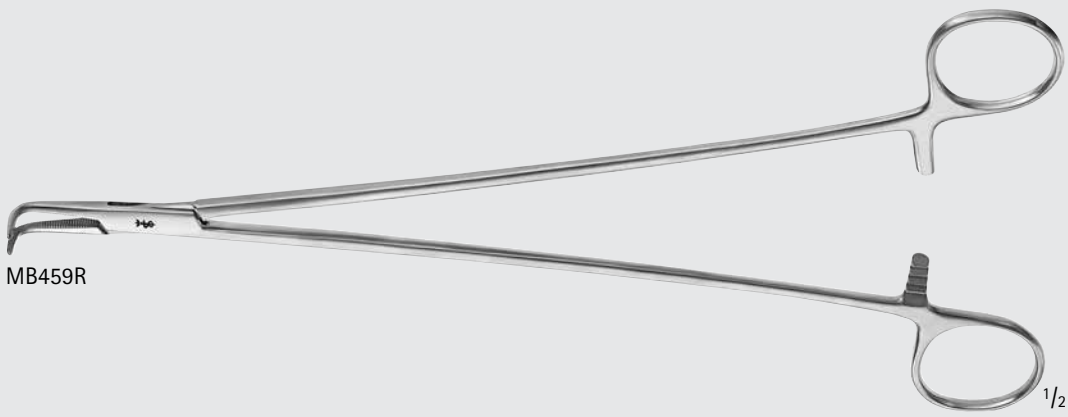

# General Surgery

## Dissecting and Right Angle Forceps

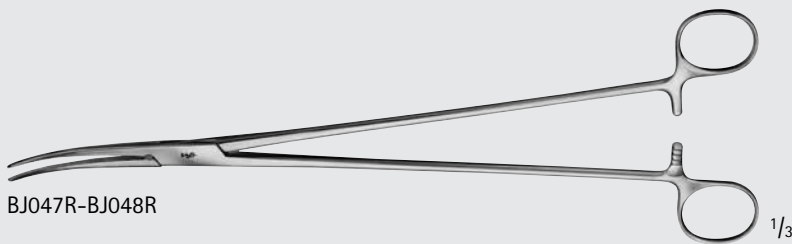
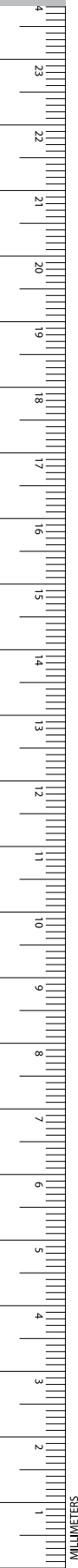

BJ047R-BJ048R



BJ047R

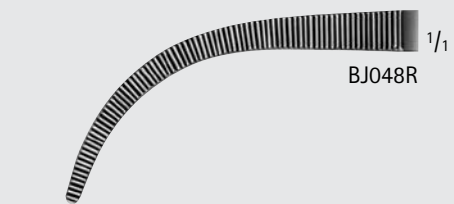

BJ048R

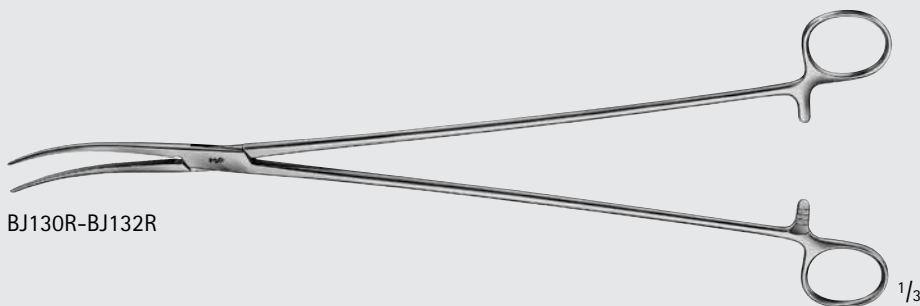

BJ130R-BJ132R

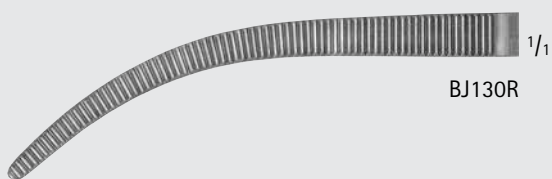

BJ130R

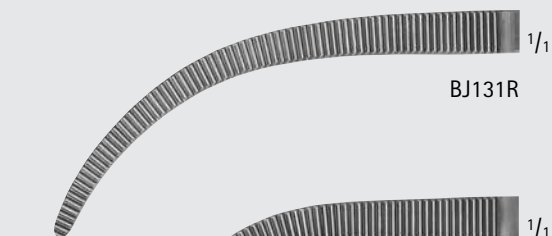

BJ131R

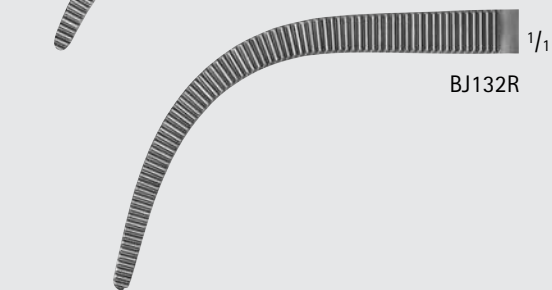

BJ132R

### ZENKER Ligature Forceps

Catalog Number	Jaw	Length (in.)
BJ047R	SLIGHT-CVD	11 3/4
BJ048R	HEAVY-CVD	11 1/2
BJ130R	SLIGHT-CVD	13 3/4
BJ131R	CVD	13 3/4
BJ132R	HEAVY-CVD	13 3/4

# General Surgery

## Dissecting and Right Angle Forceps

### MIXTER-O'SHAUGNESSY Forceps

Catalog Number	Length (in.)
BJ050R	7 1/2



BJ050R

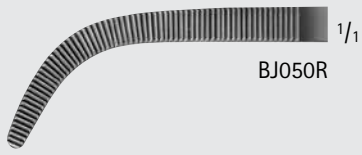

BJ050R

### FINOCHIETTO Forceps

Catalog Number	Length (in.)
BJ052R	9 5/8

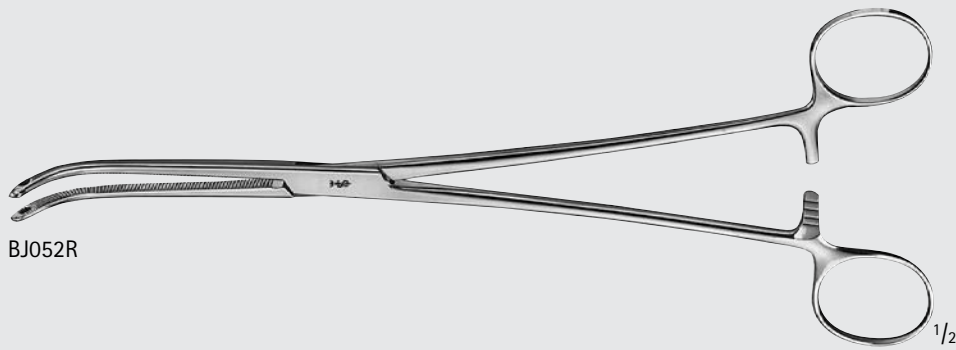

BJ052R



BJ052R



# General Surgery

## Dissecting and Right Angle Forceps

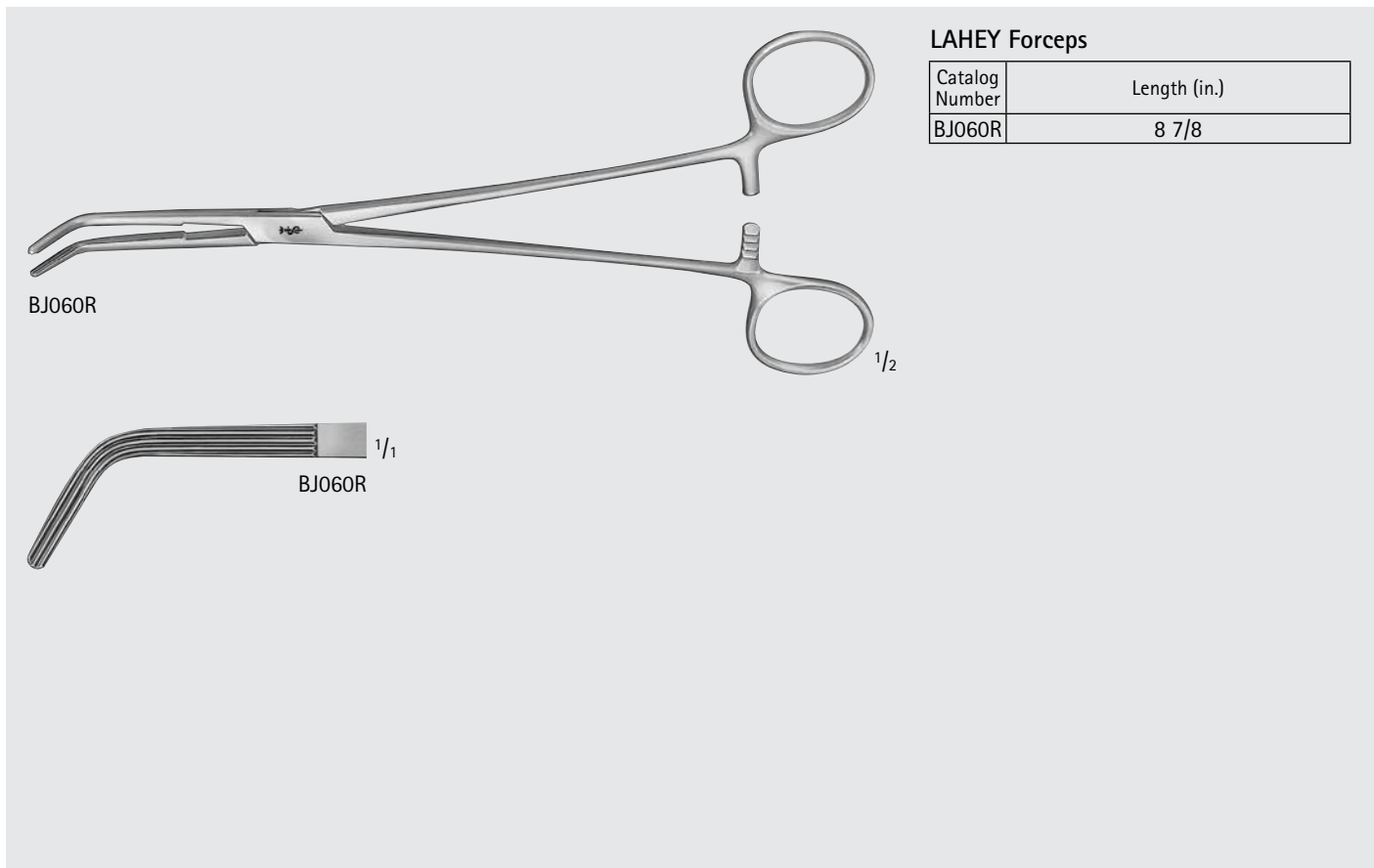

**LAHEY Forceps**

Catalog Number	Length (in.)
BJ060R	8 7/8

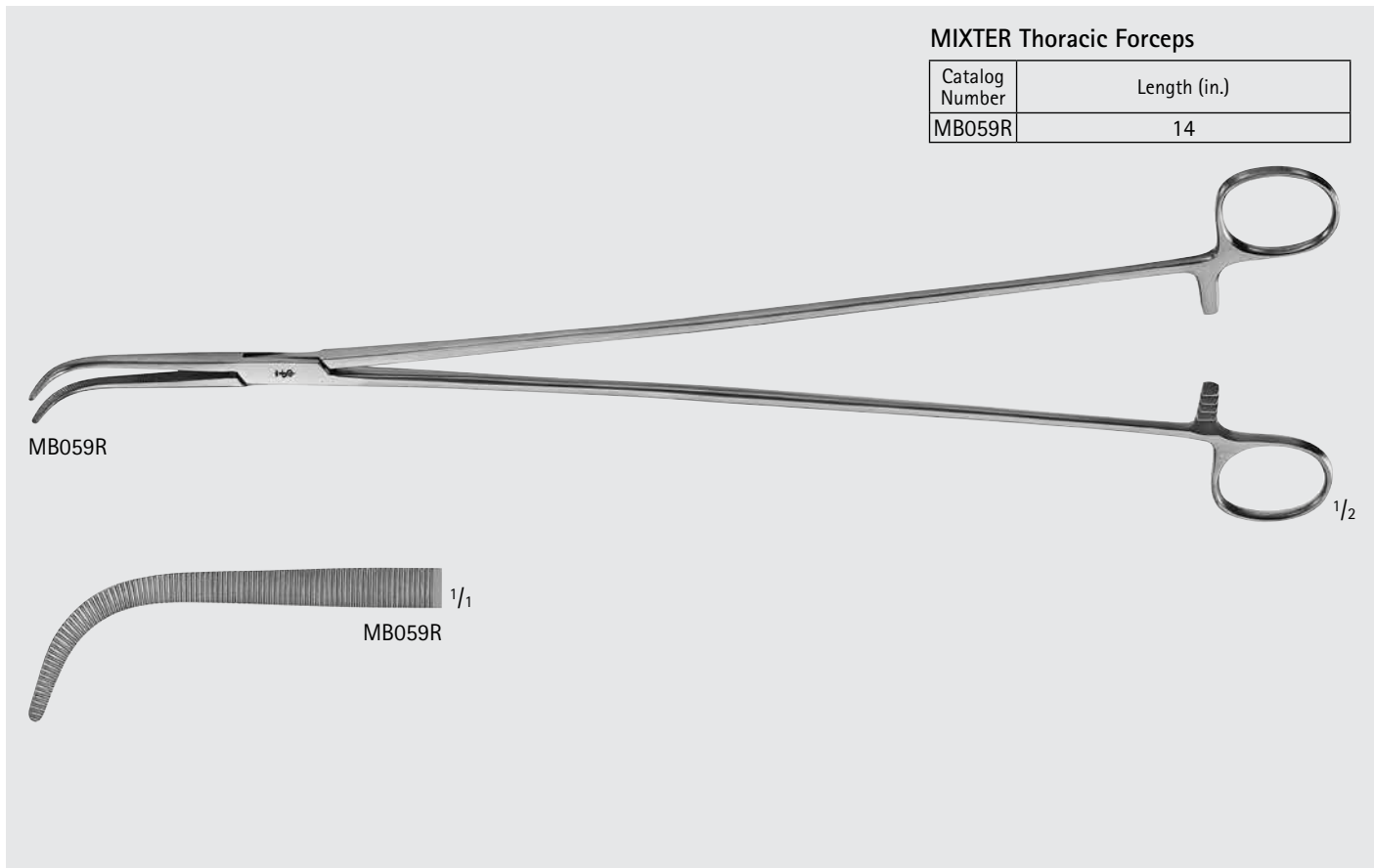

**MIXTER Thoracic Forceps**

Catalog Number	Length (in.)
MB059R	14

# General Surgery

## Dissecting and Right Angle Forceps

### MIXTER Forceps, Longitudinal Serrations

Catalog Number	Length (in.)
BJ061R	8 3/4
BJ062R	9 3/4
BJ073R	11 1/2

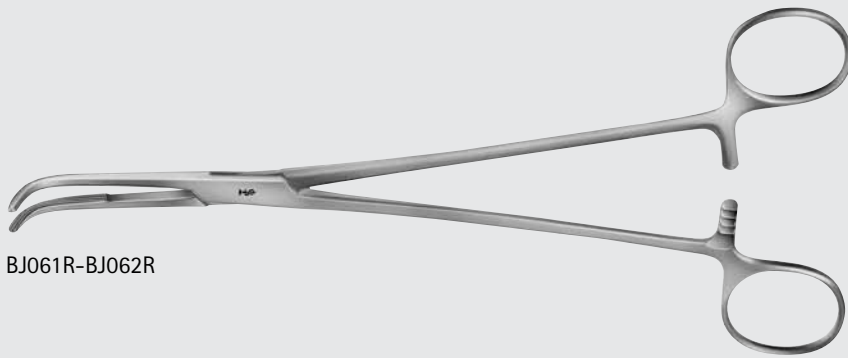

BJ061R-BJ062R



BJ061R



BJ062R

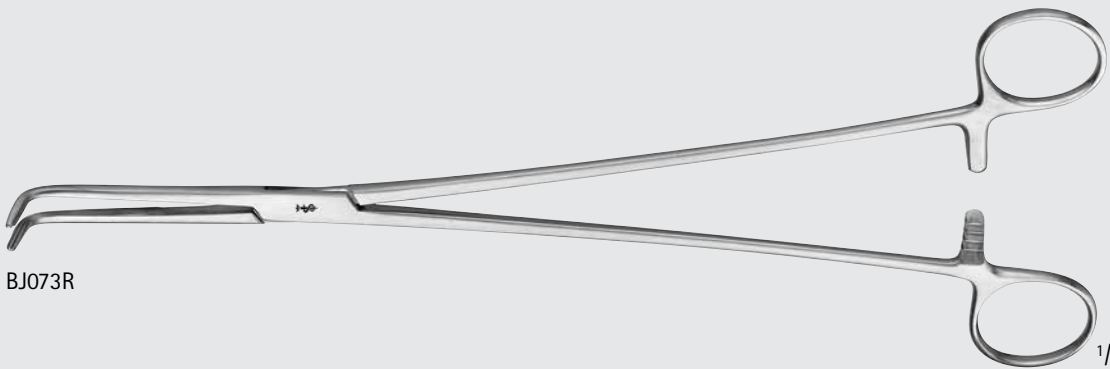

BJ073R

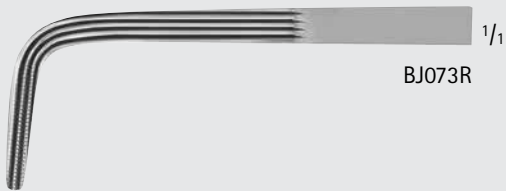

BJ073R



# General Surgery

## Dissecting and Right Angle Forceps

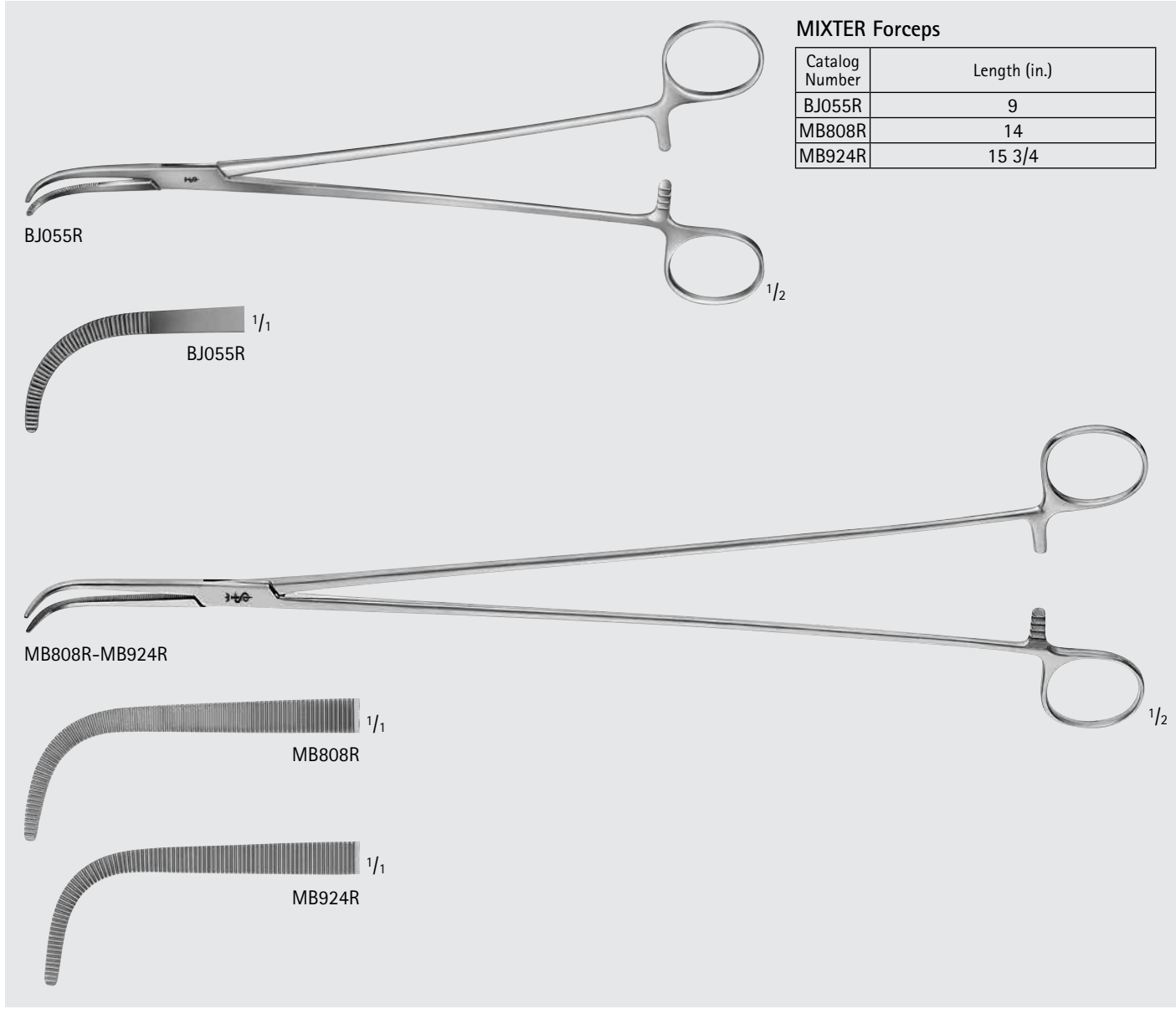

### MIXTER Forceps

Catalog Number	Length (in.)
BJ055R	9
MB808R	14
MB924R	15 3/4

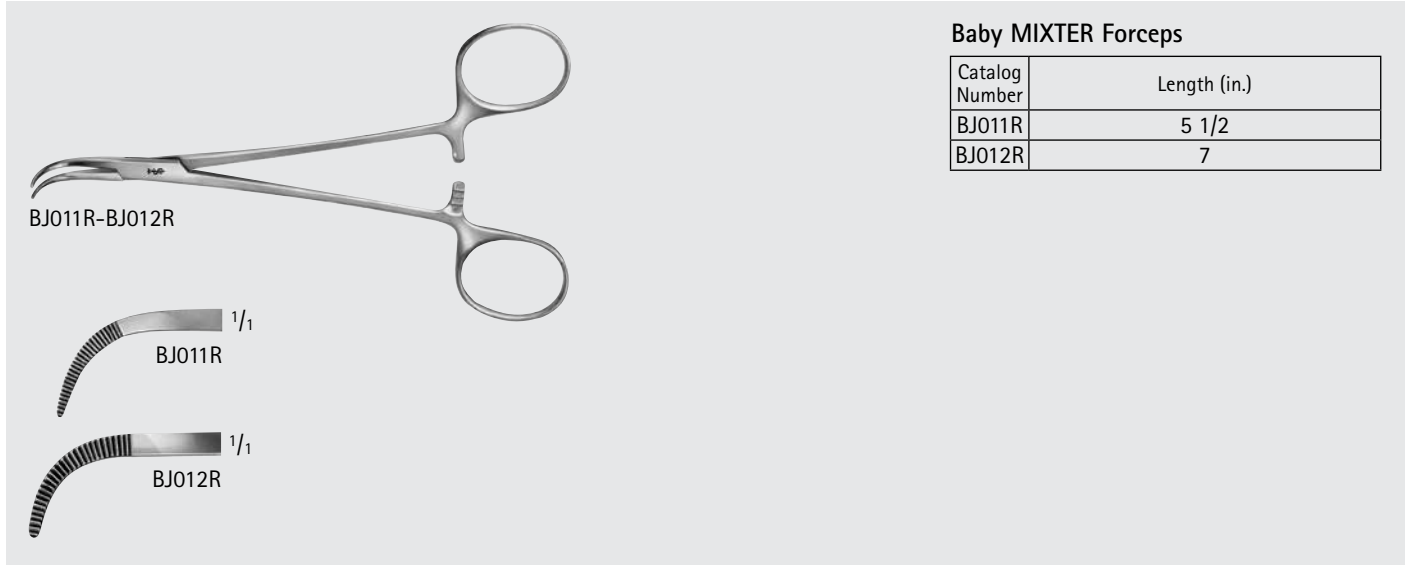

### Baby MIXTER Forceps

Catalog Number	Length (in.)
BJ011R	5 1/2
BJ012R	7

# General Surgery

## Dissecting and Right Angle Forceps

### HARRINGTON-MIXTER Forceps, Longitudinal Serrations

Catalog Number	Length (in.)
BJ072R	12 1/2

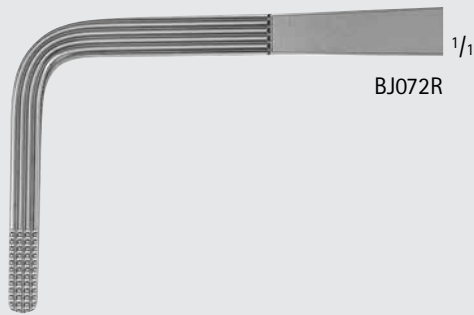
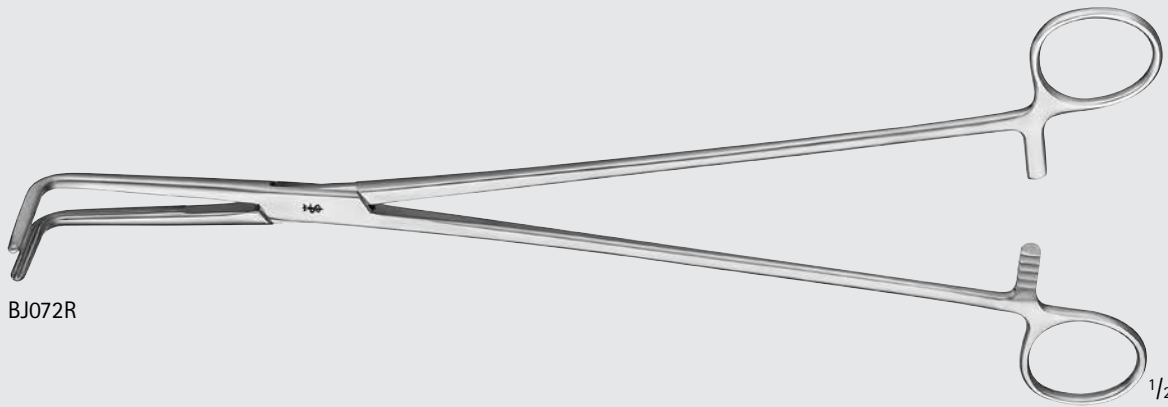

### WIKSTROEM Forceps

Catalog Number	Length (in.)
BJ051R	8

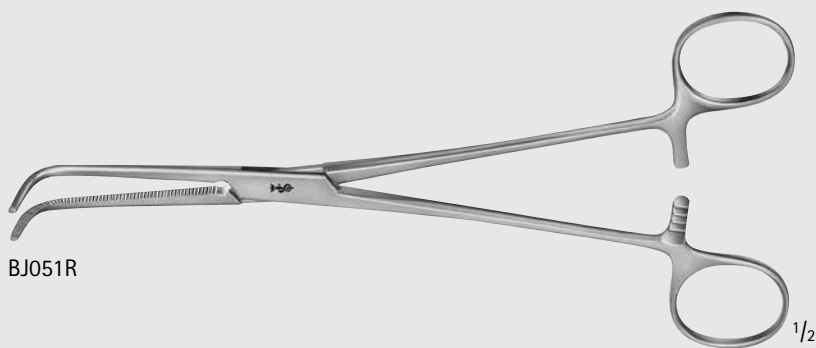

# General Surgery

## Dissecting and Right Angle Forceps



### LAWRENCE Forceps

Catalog Number	Length (in.)
BJ070R	10 5/8

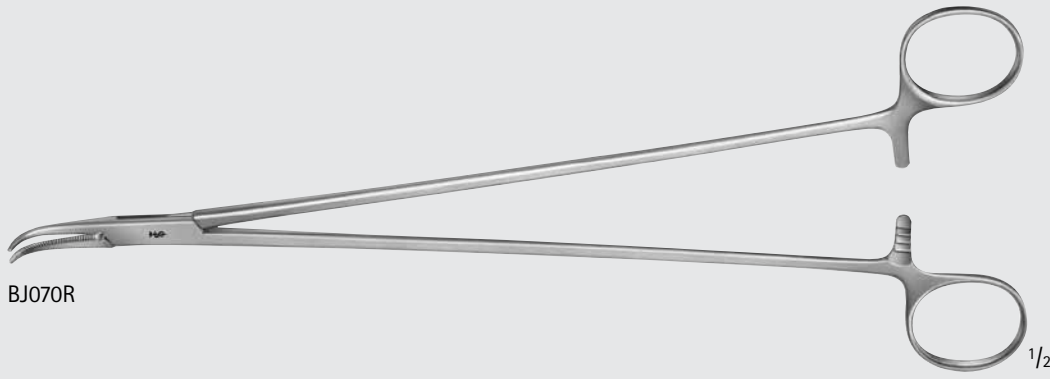

BJ070R

1/2



BJ070R

1/1

### REINHOFF Swan Neck Clamp

Catalog Number	Tip	Jaw	Handle	Length (in.)
US116	SERR	CVD	CVD	10 1/4

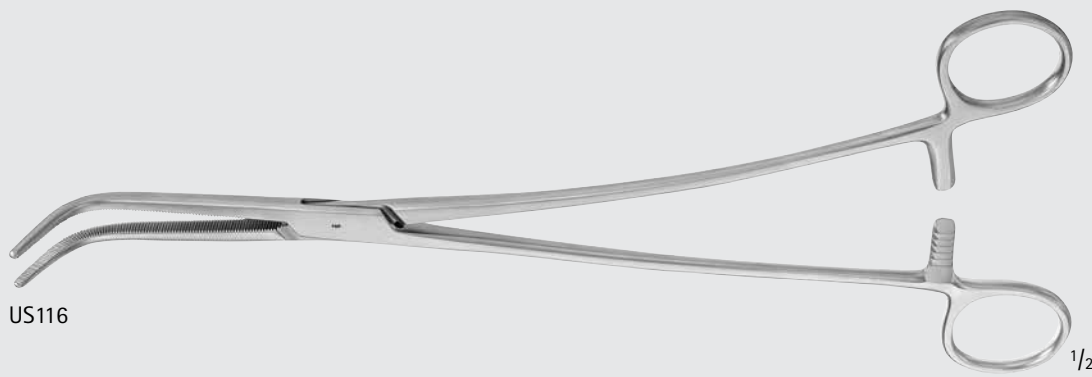

US116

1/2



US116

1/1

# General Surgery

## Dissecting and Right Angle Forceps

### KIEBACK Forceps

Catalog Number	Jaw	Length (in.)
BJ075R	CVD, LONGITUDINAL SERR	9 1/4

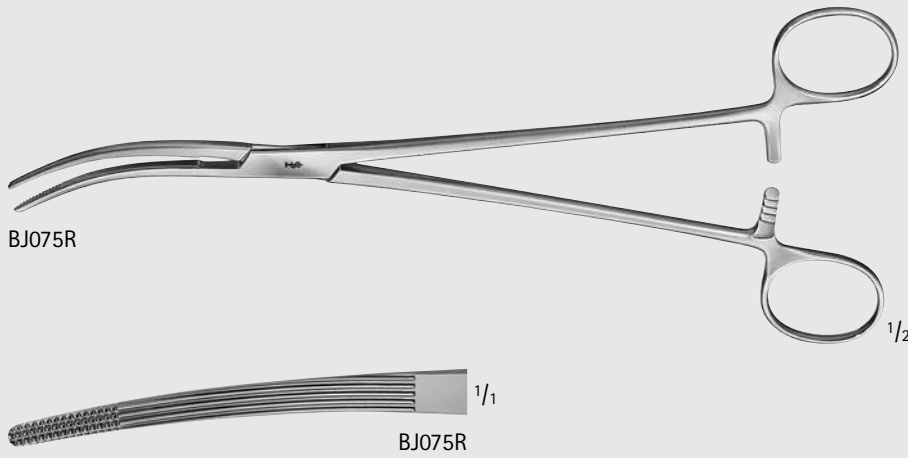

### COLLIER-ANDERSON Forceps

Catalog Number	Jaw	Length (in.)
MB897R	CVD, LONGITUDINAL SERR	10
MB898R	CVD, LONGITUDINAL SERR	11

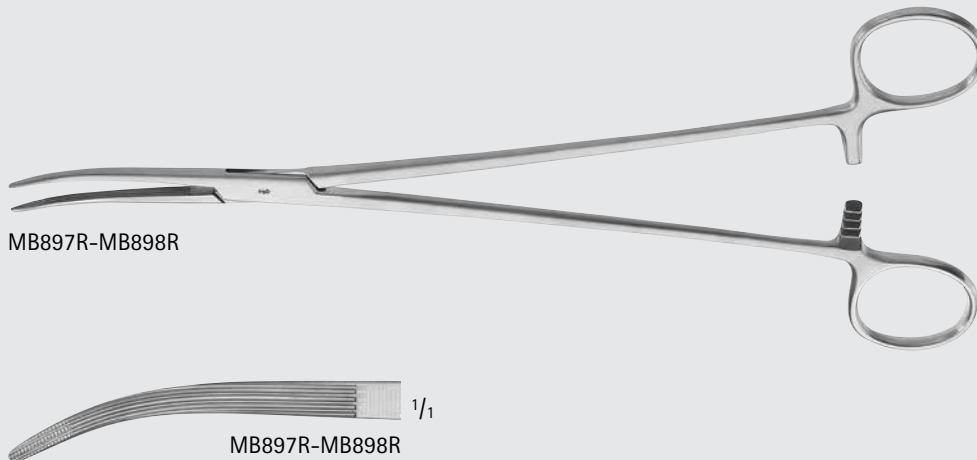

### DEBAKEY-COLLIER Forceps

Catalog Number	Jaw	Length (in.)
MB899R	CVD, SERR	8

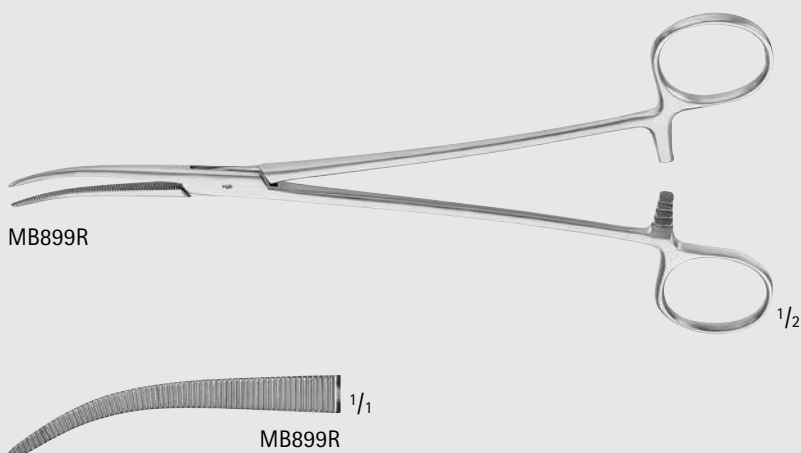

# General Surgery

## Towel and Tubing Clamps



BF407R

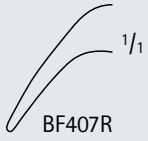

BF407R

### JONES Towel Clamp

Catalog Number	Length (in.)
BF407R	3 1/4

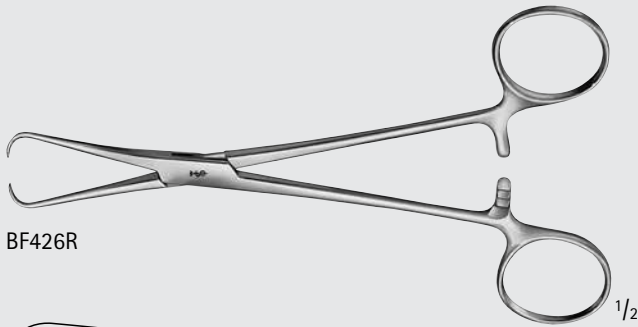

BF426R

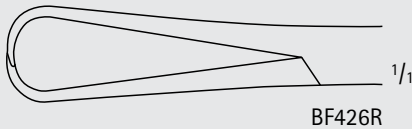

BF426R

### BERNHARD Towel Clamp

Catalog Number	Length (in.)
BF426R	6 1/4



BF431R-BF433R



BF431R

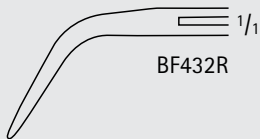

BF432R

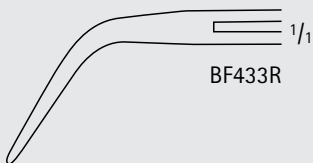

BF433R

### BACKHAUS Towel Clamp

Catalog Number	Length (in.)
BF431R	3 1/2
BF432R	4 1/4
BF433R	5 1/4



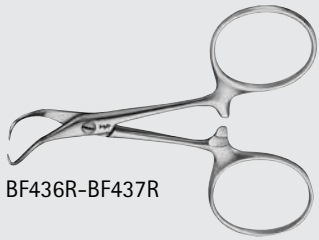

BF436R-BF437R

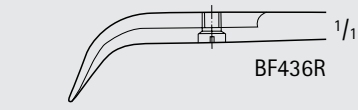

BF436R

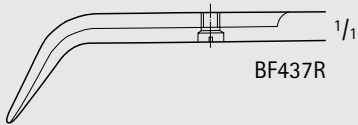

BF437R

**BACKHAUS Towel Clamp, W/ Screw**

Catalog Number	Length (in.)
BF436R	3 1/8
BF437R	4 1/8

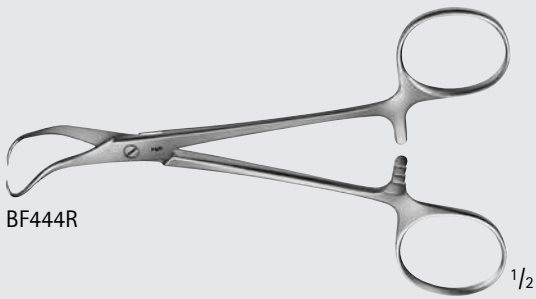

BF444R

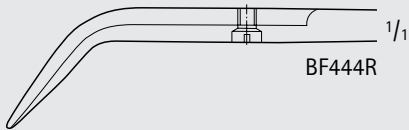

BF444R

**BACKHAUS-KOCHER Towel Clamp, W/ Screw**

Catalog Number	Length (in.)
BF444R	5 1/4



BF448R

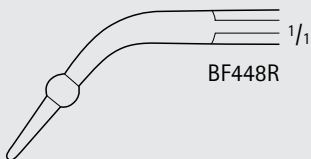

BF448R

**ROEDER Towel Clamp, W/ Ball On Jaws**

Catalog Number	Length (in.)
BF448R	5 1/4



INCHES

# General Surgery

## Towel and Tubing Clamps

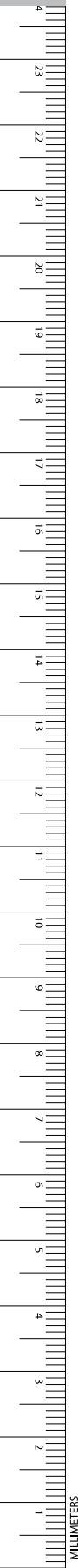

BF464R

1/2



BF464R

1/1

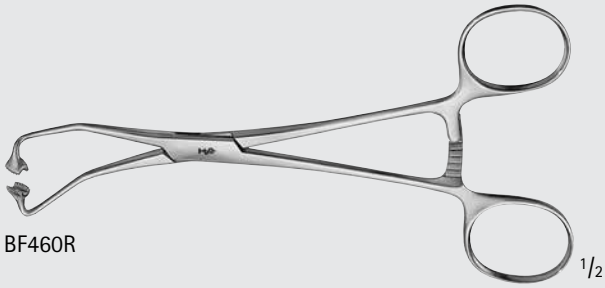

BF460R

1/2

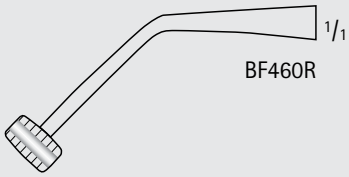

BF460R

1/1

### Towel Clamp, Paper Drape

Catalog Number	Length (in.)
BF464R	5 1/2
BF460R	6

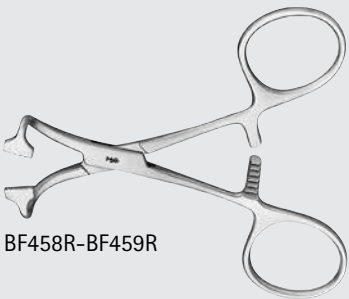

BF458R-BF459R

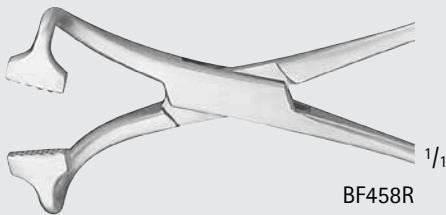

BF458R

1/1

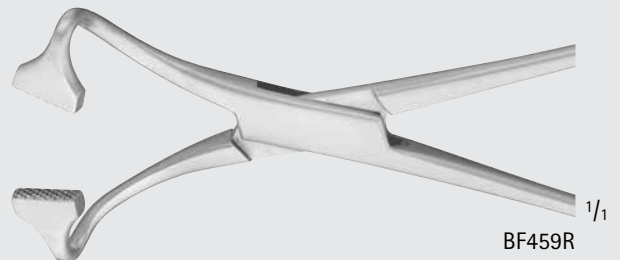

BF459R

1/1

### Non-Perforating Towel Forceps

Catalog Number	Length (in.)
BF458R	4
BF459R	5 1/2

# General Surgery

## Towel and Tubing Clamps

### LORNA Non-Perforating Towel Clamp

Catalog Number	Length (in.)
BF461R	3 3/4
BF463R	5 1/8

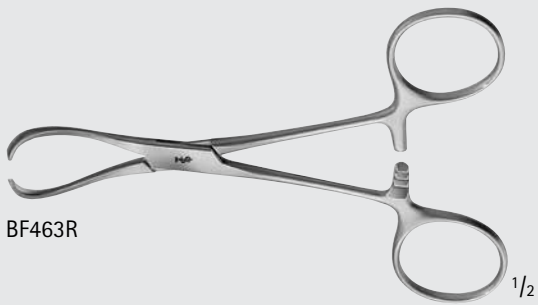

### Tubing Clamp, W/ Guard

Catalog Number	Jaw	Length (in.)
MD652	SERR	6
MD653	SERR	7
MD654	SERR	7 7/8

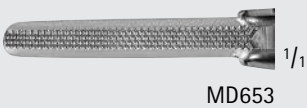
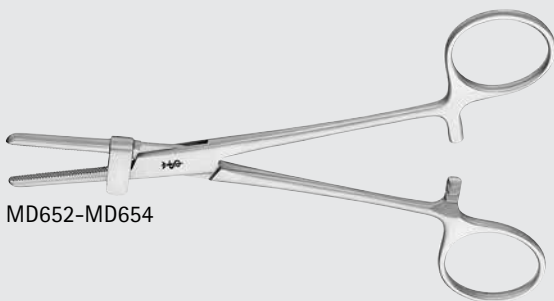

# General Surgery

## Skin Hooks

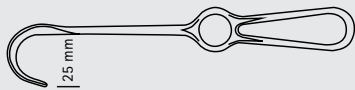

Dimensions for blade size of retractors  
 1st number = depth      Example: 25 x 38 mm  
 2nd number = width



OL620R, MA185R, OL622R-OL624R, MD581



### JOSEPH Skin Hook

Catalog Number	Tip	Prongs	Tip Size (mm)	Length (in.)
OL620R	SHARP	1	-	6 1/2
MA185R	SHARP	2	2	6 1/4
OL622R	SHARP	2	3	6 1/2
OL623R	SHARP	2	6	6 1/2
OL624R	SHARP	2	8	6 1/2
MD581	SHARP	2	10	6 1/2



OL621R

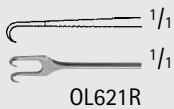

### FREER Double Hook

Catalog Number	Tip	Tip Size (mm)	Length (in.)
OL621R	SHARP	2.0 x 3.2	6



OA332R-OA333R

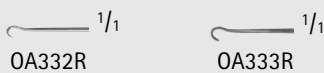

### GRAEFE Hook

Catalog Number	Tip	Length (in.)
OA332R	SHARP	5
OA333R	BLUNT	5



OA334R-OA335R

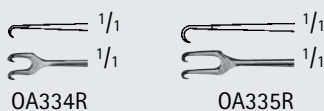

### GUTHRIE Double Hook

Catalog Number	Tip	Length (in.)
OA334R	SHARP	5
OA335R	SHARP	5 1/8





OA336R-OA338R

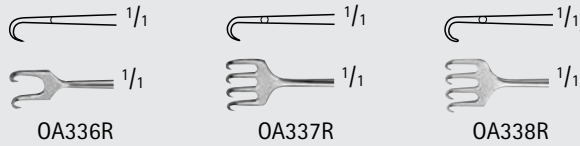

**ROLLET Hook Retractor**

Catalog Number	Tip	Blade End	Tip Size (mm)	Length (in.)
OA336R	SHARP	2 PRONGS	2.2 x 4.5	5 1/8
OA337R	SHARP	4 PRONGS	2.5 x 7.0	5 1/4
OA338R	BLUNT	4 PRONGS	2.2 x 7.0	5 1/4



OL615R

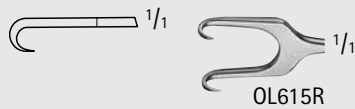

**MCINDOE Hook**

Catalog Number	Tip	Blade End	Tip Size (mm)	Length (in.)
OL615R	SHARP	2 PRONGS	9	6



OA340R

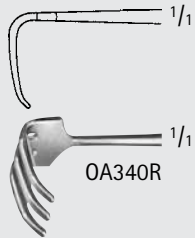

**PAUL Tendon Hook**

Catalog Number	Tip	Blade End	Tip Size (mm)	Length (in.)
OA340R	BLUNT	3 PRONGS	11 x 8	4 3/4



OA351R

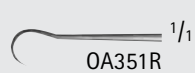

**JAEGER Hook Retractor, Fine**

Catalog Number	Tip	Length (in.)
OA351R	SHARP	5 1/4



OL610R

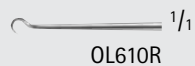

**KILNER Skin Hook**

Catalog Number	Tip	Length (in.)
OL610R	SHARP	6 1/4



OL611R-OL612R



**GILLIES Skin Hook**

Catalog Number	Tip	Hook End	Length (in.)
OL611R	SHARP	SMALL	7
OL612R	SHARP	LARGE	7

# General Surgery

## Skin Hooks

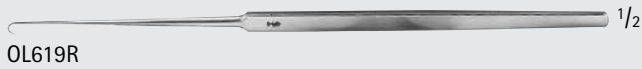

### COTTLE Hook

Catalog Number	Tip	Hook End	Length (in.)
OL617R	SHARP	ANG	6 1/4
OL619R	SHARP	HVY-CVD	6 1/4



### KLEINERT-KUTZ Skin Hook

Catalog Number	Size	Tip	Tip Size (mm)	Length (in.)
OL601R	1	SHARP	2.5	6 1/4
OL602R	2	SHARP	4.2	6 1/4
OL603R	3	SHARP	4.8	6 1/4



### Prong Micro Hooks

Catalog Number	Tip	Tip Size (mm)	Length (in.)
MB885R	SHARP	1	5 5/8
MB886R	SHARP	2	5 5/8
MB887R	BLUNT	2	5 5/8
MB888R	SHARP	2	5 5/8
MB889R	SHARP	5	5 5/8
MB890R	SHARP	7	5 5/8
MB891R	SHARP	10	5 5/8



BT075R

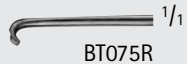

BT075R

**BROM Vein Hook**

Catalog Number	Length (in.)
BT075R	6 3/4



BT100R

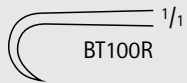

BT100R

**BERGMANN Hook**

Catalog Number	Tip	Tip Size (mm)	Length (in.)
BT100R	SHARP	7	5 1/2



BT161R

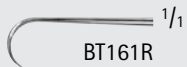

BT161R

**EMMET Fistula Hook**

Catalog Number	Tip	Length (in.)
BT161R	SHARP	8 3/4



BT166R

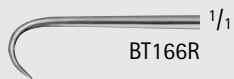

BT166R



BT167R

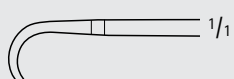

BT167R

**SIMON Fistula Hook**

Catalog Number	Tip	Blade End	Length (in.)
BT166R	SHARP	1 PRONG	8 3/4
BT167R	SHARP	2 PRONGS	8 3/4

# General Surgery

## Hand Held Retractors



**Baby SENN-MILLER Retractor, Flat Handle**

Catalog Number	Tip	Blade End	Blade Size (mm)	Length (in.)
BT006R	SHARP	3 PRONGS	8 x 7 / 22 x 7	6 1/8
BT007R	BLUNT	3 PRONGS	8 x 7 / 22 x 7	6 1/8

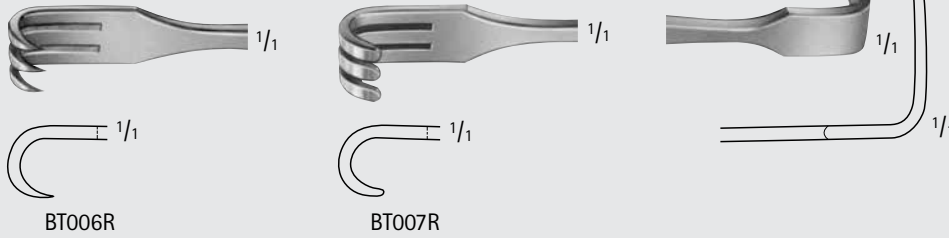

**SENN-MILLER Retractor**

Catalog Number	Tip	Blade End	Blade Size (mm)	Length (in.)
BT008R	SHARP	3 PRONGS	8 x 7 / 18 x 5.5	6 1/2

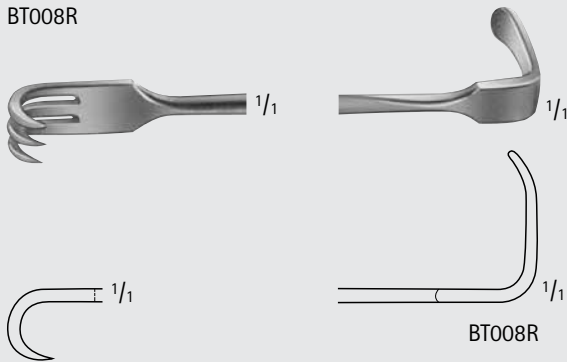

**SENN Retractor, Round Tapered Handle**

Catalog Number	Tip	Blade End	Blade Size (mm)	Length (in.)
MG276R	SHARP	3 PRONGS	9 x 10 / 22 x 7	6 1/4
MG277R	BLUNT	3 PRONGS	9 x 10 / 22 x 7	6 1/4

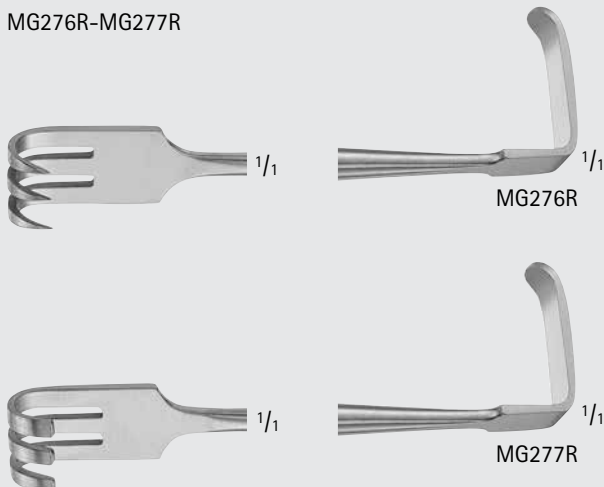



**RAGNELL Retractor**

Catalog Number	Blade Size (mm)	Length (in.)
BT004R	3 x 5 / 6.3 x 14	6
MG274R	3 x 11 / 5.4 x 17	6

**DAVIS Double Ended Retractor**

Catalog Number	Blade Size (mm)	Length (in.)
MG475R	19 x 9 / 23 x 6.4	6

**Double Ended Retractor**

Catalog Number	Blade Size (mm)	Length (in.)
BT187R	20 x 15 / 20 x 19	8

**GOELET Retractor**

Catalog Number	Blade Size (mm)	Length (in.)
MD497	30 x 32 / 35 x 40	7 1/2

# General Surgery

## Hand Held Retractors

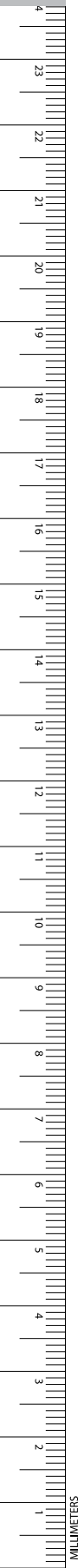

BT010R

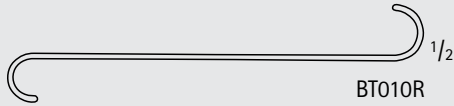

BT010R

### LUER Retractor

Catalog Number	Blade Size (mm)	Length (in.)
BT010R	10 x 8 / 12 x 11	4 1/4



BT020R



BT020R



BT021R

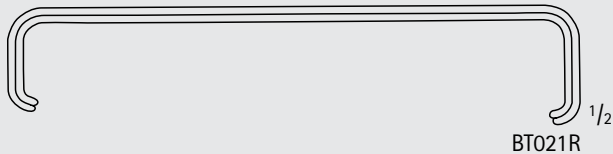

BT021R

### FARABEUF Retractor, 2/Set

Catalog Number	Blade Size (mm)	Length (in.)
BT020R	25 x 10 / 32 x 12 22 x 10 / 29 x 12	5
BT021R	23 x 16 / 28 x 16 19 x 16 / 24 x 16	6



MB984R

### MAYO-COLLINS Retractor, 2/Set

Catalog Number	Blade Size (mm)	Length (in.)
MB984R	31 x 20 / 30 x 18 28 x 19 / 26 x 17	5 7/8



BT022R

1/2

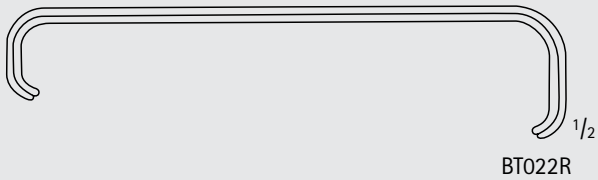

BT022R

1/2

**COLLIN Retractor, 2/Set**

Catalog Number	Blade Size (mm)	Length (in.)
BT022R	21 x 14 / 32 x 16 17 x 14 / 28 x 16	6



BT012R

1/2

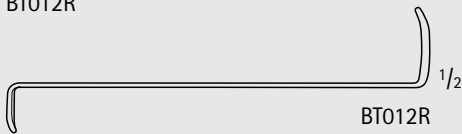

BT012R

1/2

**CRILE Retractor**

Catalog Number	Blade Size (mm)	Length (in.)
BT012R	11 x 4 / 19 x 6	4 1/4

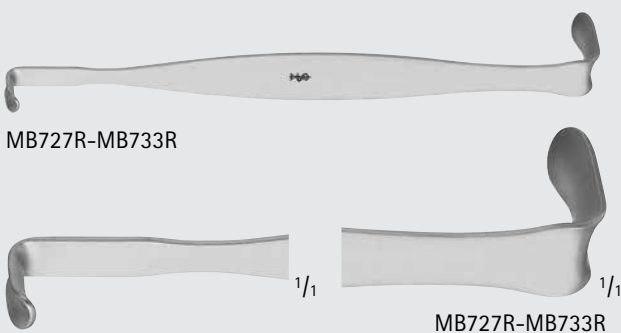

MB727R-MB733R

1/1

MB727R-MB733R

1/1

**CRILE Retractor**

Catalog Number	Size	Blade Size (mm)	Length (in.)
MB727R	1	3 x 11 / 6 x 21	4 1/4
MB728R	2	6 x 13 / 10 x 21	6 1/8
MB729R	3	16 x 25 / 17 x 35	6 1/4
MB730R	4	22 x 29 / 29 x 44	7
MB731R	5	29 x 41 / 35 x 51	7
MB732R	6	32 x 64 / 35 x 70	7 7/8
MB733R	7	41 x 76 / 51 x 79	8 7/8



INCHES

# General Surgery

## Hand Held Retractors



BT011R

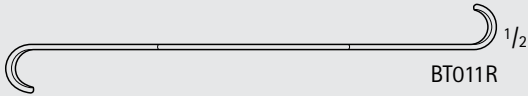

BT011R

### ROSE Tracheal Retractor

Catalog Number	Blade Size (mm)	Length (in.)
BT011R	10 x 12 / 11 x 15	5 1/8



MG474R

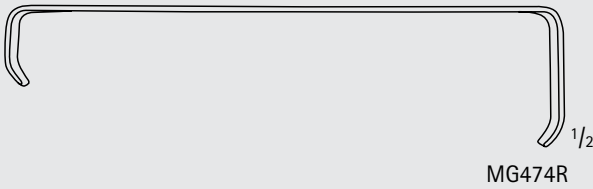

MG474R

### Children's Hospital Retractor

Catalog Number	Blade Size (mm)	Length (in.)
MG474R	11 x 22 / 14 x 35	4 1/2



BT025R

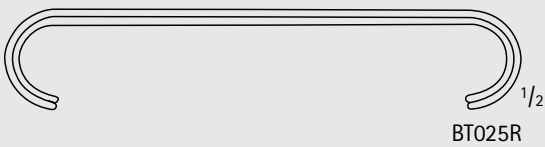

BT025R



BT026R

### PARKER Retractor, 2/Set

Catalog Number	Blade Size (mm)	Length (in.)
BT025R	22 x 15 / 22 x 15 18 x 15 / 18 x 15	5 1/4
BT026R	31 x 25 / 27 x 25 31 x 25 / 27 x 25	7



BT034R-BT036R

ROUX Retractor

Catalog Number	Blade Size (mm)	Length (in.)
BT034R	20 x 22 / 25 x 29	6
BT035R	25 x 26 / 30 x 38	6 1/4
BT036R	28 x 29 / 33 x 44	6 3/4



BT034R

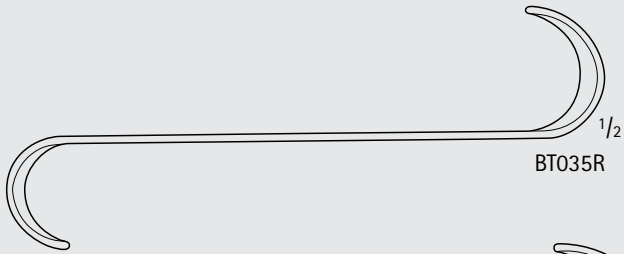

BT035R

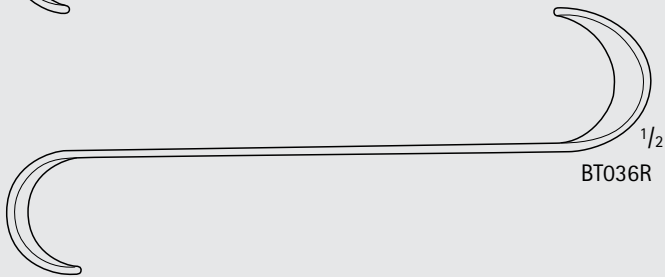

BT036R



INCHES

# General Surgery

## Hand Held Retractors



BT030R-BT033R  $\frac{1}{2}$

BT031R  $\frac{1}{2}$

BT032R  $\frac{1}{2}$

BT033R  $\frac{1}{2}$

### ROUX Retractor

Catalog Number	Blade Size (mm)	Length (in.)
BT030R	COMPLETE SET BT031R-BT033R	-
BT031R	21 x 22 / 27 x 28	5 3/4
BT032R	26 x 26 / 32 x 26	6 1/8
BT033R	30 x 30 / 36 x 44	6 1/2

MB584R-MB585R  $\frac{1}{2}$

MB584R  $\frac{1}{2}$

MB585R  $\frac{1}{2}$

### ROUX Retractor

Catalog Number	Blade Size (mm)	Length (in.)
MB584R	25 x 26 / 30 x 37	6 1/2
MB585R	28 x 28 / 29 x 40	6 1/2

BT029R  $\frac{1}{2}$

BT029R  $\frac{1}{2}$

### ROUX Retractor, Long

Catalog Number	Blade Size (mm)	Length (in.)
BT029R	28 x 28 / 46 x 28	7 1/2

# General Surgery

## Hand Held Retractors



BT040R

### MATHIEU Retractor, 2/Set

Catalog Number	Blade Size (mm)	Length (in.)
BT040R	42 x 13 / 41 x 13 45 x 25 / 40 x 25	7 7/8

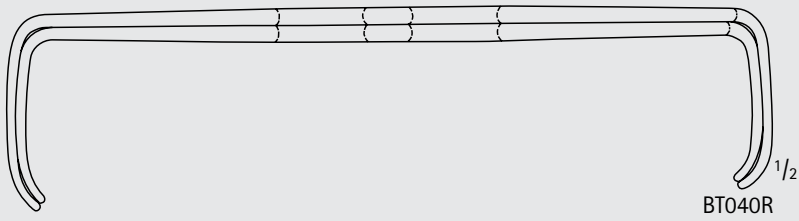

BT040R



BT041R

### US Army Retractor, 2/Set

Catalog Number	Blade Size (mm)	Length (in.)
BT041R	26 x 15 / 22 x 15 43 x 15 / 39 x 15	8 3/4

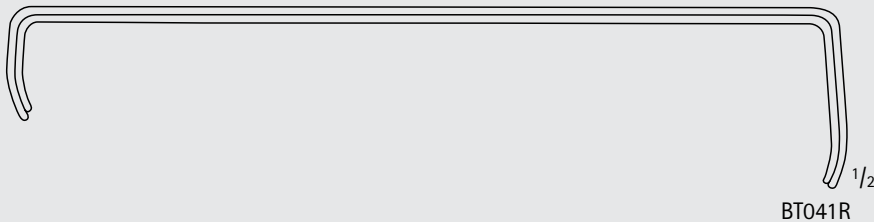

BT041R



# General Surgery

## Hand Held Retractors

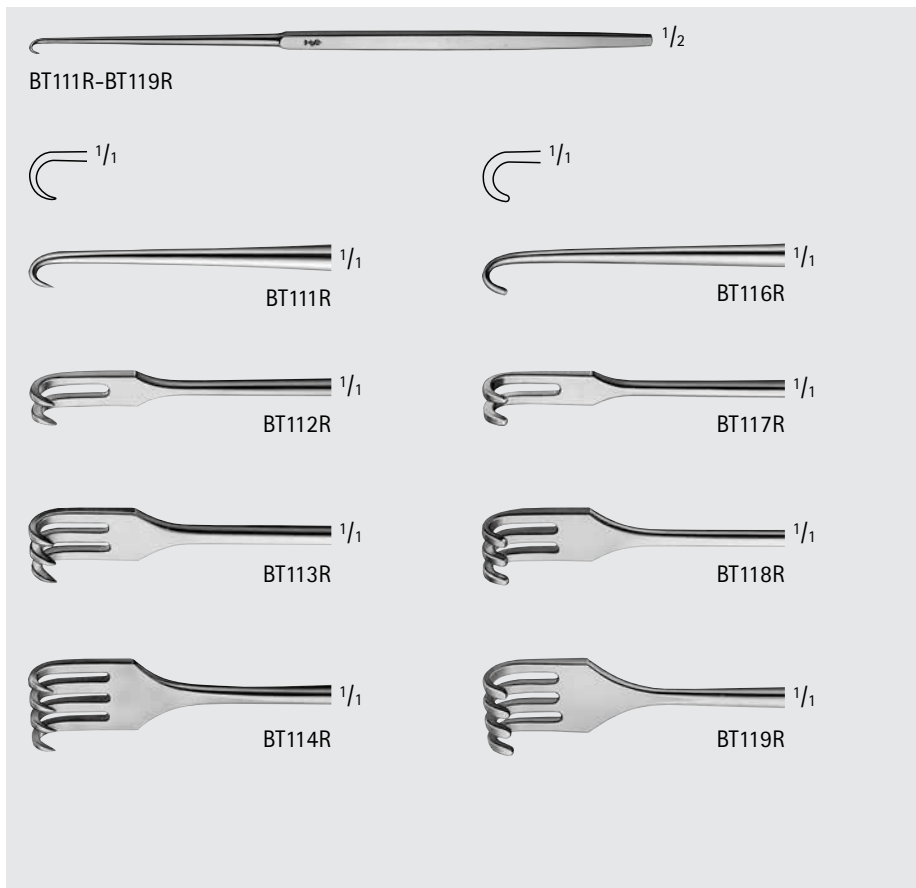

### Hook, Small Curve

Catalog Number	Tip	Blade End	Blade Size (mm)	Length (in.)
BT111R	SHARP	1 PRONG	-	6 1/2
BT112R	SHARP	2 PRONGS	5.0 x 4.2	6 1/2
BT113R	SHARP	3 PRONGS	5.0 x 7.0	6 1/2
BT114R	SHARP	4 PRONGS	5.0 x 9.5	6 1/2
BT116R	BLUNT	1 PRONG	-	6 1/2
BT117R	BLUNT	2 PRONGS	4.5 x 4.2	6 1/2
BT118R	BLUNT	3 PRONGS	4.5 x 7.0	6 1/2
BT119R	BLUNT	4 PRONGS	4.5 x 9.0	6 1/2

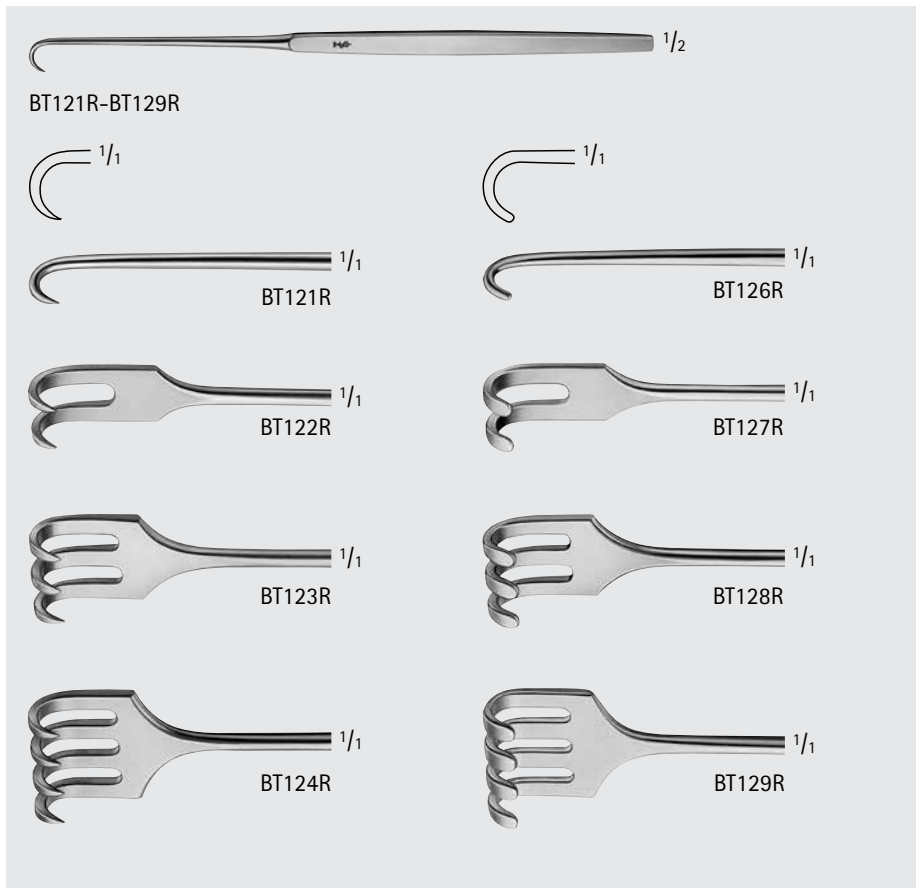

### Hook, Large Curve

Catalog Number	Tip	Blade End	Blade Size (mm)	Length (in.)
BT121R	SHARP	1 PRONG	-	6 1/2
BT122R	SHARP	2 PRONGS	7.5 x 7.5	6 1/2
BT123R	SHARP	3 PRONGS	7.5 x 10.0	6 1/2
BT124R	SHARP	4 PRONGS	7.5 x 14.0	6 1/2
BT126R	BLUNT	1 PRONG	-	6 1/2
BT127R	BLUNT	2 PRONGS	6.8 x 7.5	6 1/2
BT128R	BLUNT	3 PRONGS	6.8 x 10.0	6 1/2
BT129R	BLUNT	4 PRONGS	6.8 x 14.0	6 1/2

**CRILE Hook and Dissector**

Catalog Number	Length (in.)
MB060R	11 3/4



**KLAPP Tendon Hook**

Catalog Number	Tip	Blade End	Blade Size (mm)	Length (in.)
BT172R	BLUNT	4 PRONGS	15 x 11	6 7/8

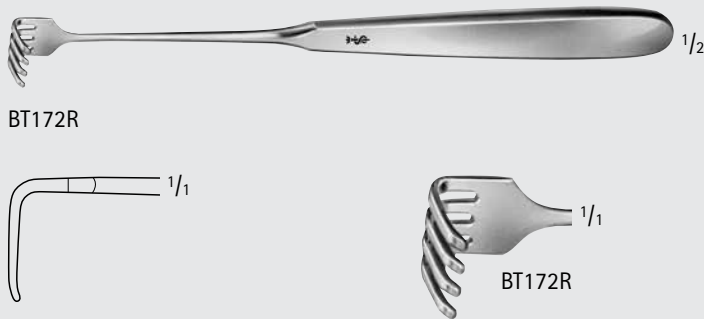

**Vein Retractor**

Catalog Number	Blade Size (mm)	Length (in.)
BT179R	10 x 13	6 1/4

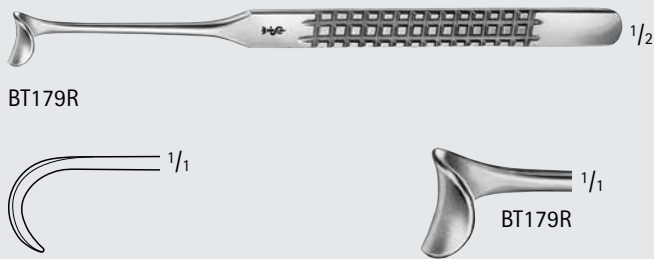

**KOENIG Vein Retractor**

Catalog Number	Blade Size (mm)	Length (in.)
BT182R	13 x 13	7
BT183R	12 x 16	7

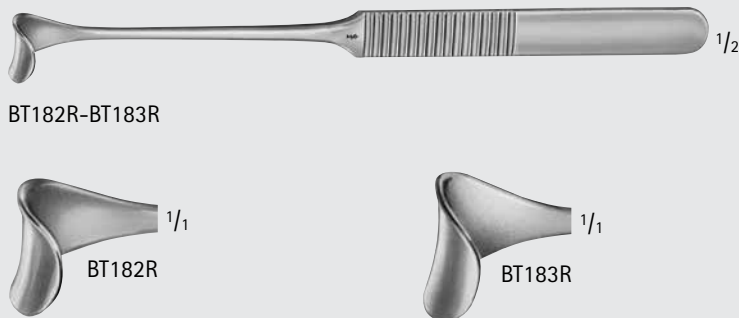

INCHES

# General Surgery

## Hand Held Retractors



BT193R-BT198R

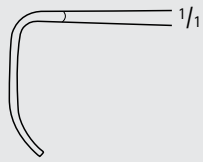

BT193R

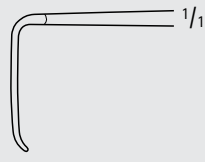

BT194R

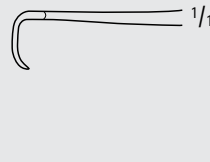

BT195R



BT196R



BT197R

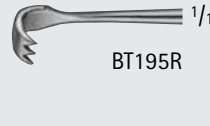

BT198R

### MEYERDING Thumb Retractor

Catalog Number	Blade Size	Size (#)	Blade Size (mm)	Length (in.)
BT193R	A	1	18 x 7	7
BT194R	B	2	16 x 5	7
BT195R	C	3	7 x 4	7
BT196R	D	4	5 x 10	7
BT197R	E	5	11 x 4	7
BT198R	F	6	6 x 4	7



BT190R



BT190R

### CUSHING-KOCHER Retractor

Catalog Number	Blade Size (mm)	Length (in.)
BT190R	10 x 10	6 7/8



BT184R-BT185R



BT184R



BT185R

### CUSHING Vein Retractor

Catalog Number	Blade Size (mm)	Length (in.)
BT184R	10 x 13	8
BT185R	14 x 18	8

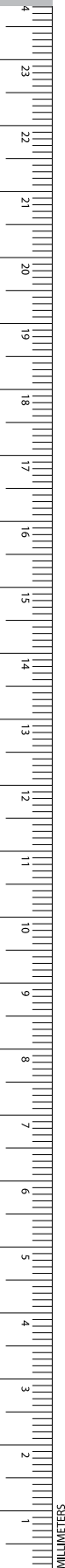

**CUSHING Vein Retractor  
(continued)**

Catalog Number	Blade Size (mm)	Length (in.)
BT200R	14 x 11	9 3/4
BT202R	22 x 15	9 3/4



BT200R-BT202R



BT200R



BT202R

**CUSHING Vein Retractor**

Catalog Number	Blade Size (mm)	Length (in.)
MB912R	14	12 1/2
MB913R	14	14
MB914R	14	16



MB912R-MB914R



MB912R-MB914R

**GIL VERNET Retractor, Malleable**

Catalog Number	Blade Size (mm)	Length (in.)
MB766R	9	11 1/4
MB767R	11	11 1/4
MB768R	13	11 1/4
MB769R	18	11 1/4



MB766R-MB769R



MB766R-MB769R



INCHES

# General Surgery

## Hand Held Retractors



BT221R

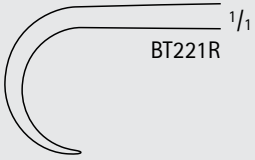

BT221R



BT222R-BT230R

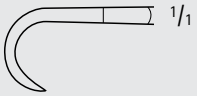

1/1

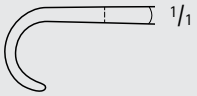

1/1



BT222R



BT227R



BT223R



BT228R



BT224R



BT229R



BT225R



BT230R

### VOLKMANN Retractor

Catalog Number	Tip	Blade End	Blade Size (mm)	Length (in.)
BT221R	SHARP	1 PRONG	8.5 x 8	8 3/4
BT222R	SHARP	2 PRONGS	9 x 8	8 7/8
BT223R	SHARP	3 PRONGS	9 x 13	8 7/8
BT224R	SHARP	4 PRONGS	9 x 19	8 7/8
BT225R	SHARP	6 PRONGS	9 x 29	8 7/8
BT227R	BLUNT	2 PRONGS	8.5 x 12	8 7/8
BT228R	BLUNT	3 PRONGS	8.5 x 13	8 7/8
BT229R	BLUNT	4 PRONGS	8.5 x 19	8 7/8
BT230R	BLUNT	6 PRONGS	8.5 x 29	8 7/8

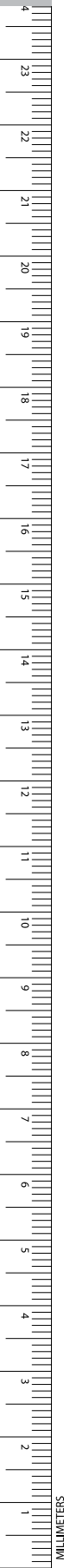

VOLKMANN Retractor, Small

Catalog Number	Tip	Blade End	Blade Size (mm)	Length (in.)
BT240R	SHARP	1 PRONG	-	8 3/4
BT241R	BLUNT	1 PRONG	-	8 3/4
BT242R	SHARP	2 PRONGS	9 x 8	8 3/4
BT243R	SHARP	3 PRONGS	9 x 13	8 3/4
BT244R	SHARP	4 PRONGS	9 x 19	8 3/4
BT246R	SHARP	6 PRONGS	9 x 29	8 3/4
BT248R	SHARP	8 PRONGS	9 x 40	8 3/4
BT257R	SEMI-S	2 PRONGS	8.5 x 8	8 3/4
BT259R	SEMI-S	3 PRONGS	8.5 x 13	8 3/4
BT260R	SEMI-S	4 PRONGS	8.5 x 19	8 3/4
BT261R	SEMI-S	6 PRONGS	8.5 x 29	8 3/4
BT265R	SEMI-S	8 PRONGS	8.5 x 40	8 3/4
BT252R	BLUNT	2 PRONGS	8 x 8	8 3/4
BT253R	BLUNT	3 PRONGS	8 x 13	8 3/4
BT254R	BLUNT	4 PRONGS	8 x 19	8 3/4
BT256R	BLUNT	6 PRONGS	8 x 29	8 3/4
BT258R	BLUNT	8 PRONGS	8 x 40	8 3/4



BT240R-BT241R

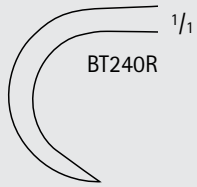

BT240R

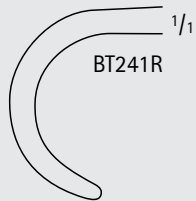

BT241R



BT242R-BT265R

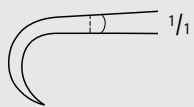

BT242R

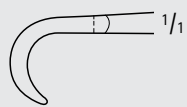

BT257R

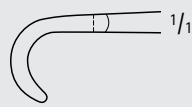

BT252R



BT243R



BT259R



BT253R



BT244R



BT260R



BT254R



BT246R



BT261R



BT256R



BT248R



BT265R



BT258R



INCHES

# General Surgery

## Hand Held Retractors

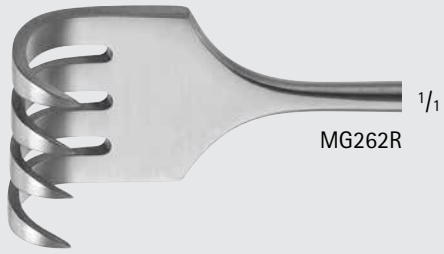
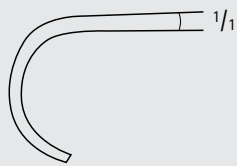
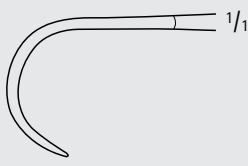
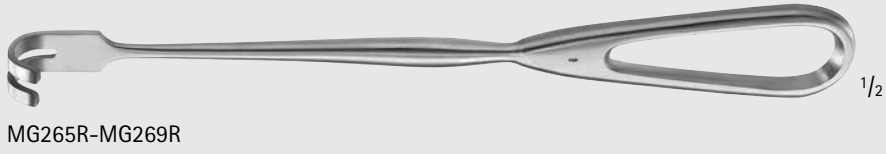
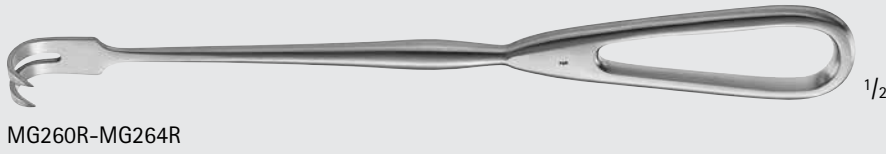
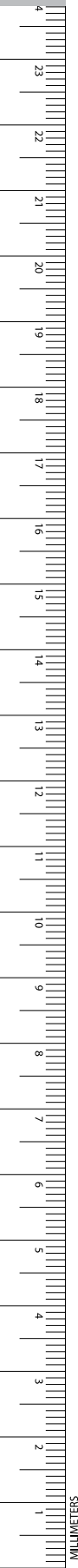

**VOLKMANN Retractor, US Version**

Catalog Number	Tip	Blade End	Blade Size (mm)	Length (in.)
MG260R	SHARP	2 PRONGS	20 x 11	8 3/4
MG261R	SHARP	3 PRONGS	20 x 18	8 3/4
MG262R	SHARP	4 PRONGS	20 x 26	8 3/4
MG264R	SHARP	6 PRONGS	20 x 40	8 3/4
MG265R	BLUNT	2 PRONGS	20 x 11	8 3/4
MG266R	BLUNT	3 PRONGS	20 x 18	8 3/4
MG267R	BLUNT	4 PRONGS	20 x 26	8 3/4
MG269R	BLUNT	6 PRONGS	20 x 40	8 3/4



BT262R-BT276R

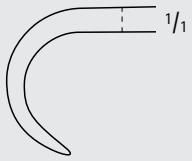

BT262R



BT263R



BT264R



BT266R

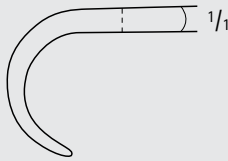

BT272R



BT273R



BT274R



BT276R

**KOCHER Retractor, Large**

Catalog Number	Tip	Blade End	Blade Size (mm)	Length (in.)
BT262R	SEMI-S	2 PRONGS	16 x 9	8 3/4
BT263R	SEMI-S	3 PRONGS	16 x 14	8 3/4
BT264R	SEMI-S	4 PRONGS	16 x 20	8 3/4
BT266R	SEMI-S	6 PRONGS	16 x 30	8 3/4
BT272R	BLUNT	2 PRONGS	15.5 x 9	8 3/4
BT273R	BLUNT	3 PRONGS	15.5 x 14	8 3/4
BT274R	BLUNT	4 PRONGS	15.5 x 20	8 3/4
BT276R	BLUNT	6 PRONGS	15.5 x 30	8 3/4

**KOERTE Retractor**

Catalog Number	Tip	Blade End	Blade Size (mm)	Length (in.)
BT279R	SEMI-S	8 PRONGS	26 x 40	9 1/2
BT278R	BLUNT	8 PRONGS	26 x 40	9 1/2



BT278R-BT279R

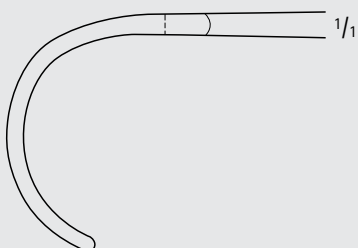

BT279R



BT278R



INCHES

# General Surgery

## Hand Held Retractors

### ISRAEL Retractor

Catalog Number	Tip	Blade End	Blade Size (mm)	Length (in.)
BT284R	BLUNT	4 PRONGS	39 x 40	10
BT285R	BLUNT	5 PRONGS	47 x 51	10
BT286R	BLUNT	6 PRONGS	53 x 62	10
BT287R	BLUNT	6 PRONGS	70 x 70	10



BT284R-BT287R

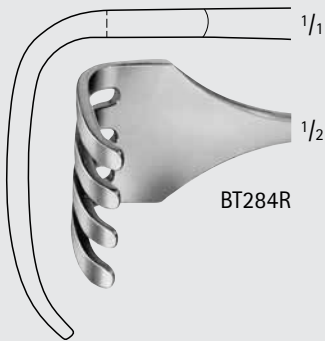

BT284R

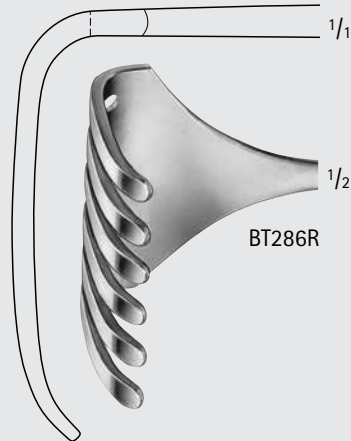

BT286R

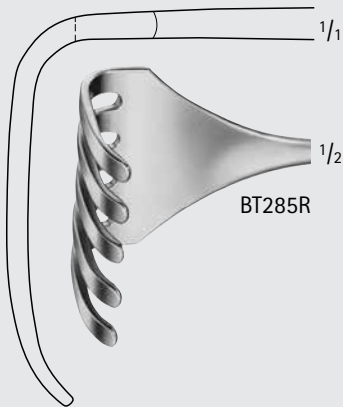

BT285R

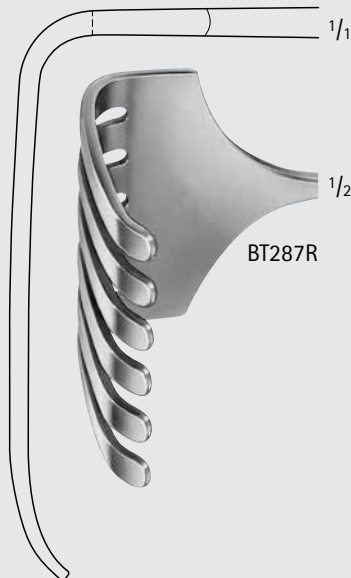

BT287R



ISRAEL Retractor, T-Handle

Catalog Number	Tip	Blade End	Blade Size (mm)	Length (in.)
MG284R	BLUNT	4 PRONGS	46 x 40	7 1/2



MG284R

1/2



MG284R

1/2

MURPHY Retractor

Catalog Number	Tip	Blade End	Length (in.)
BT293R	SHARP	3 PRONGS	7 3/4
BT294R	SHARP	4 PRONGS	7 3/4
BT296R	BLUNT	4 PRONGS	7 3/4

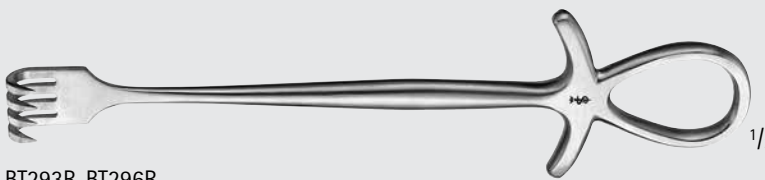

BT293R-BT296R

1/2



BT293R

1/1

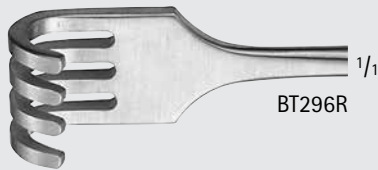

BT296R

1/1



BT294R

1/1

KOERTE-WAGNER Retractor

Catalog Number	Tip	Blade End	Blade Size (mm)	Length (in.)
BT290R	SEMI-S	8 PRONGS	28 x 40	11

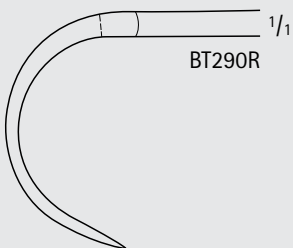

BT290R

1/1



BT290R

1/2

# General Surgery

## Hand Held Retractors



### LANGENBECK Retractor

Catalog Number	Blade Size (mm)	Length (in.)
BT311R	30 x 10	9
BT315R	40 x 10	9
BT316R	43 x 13	9

BT311R-BT316R

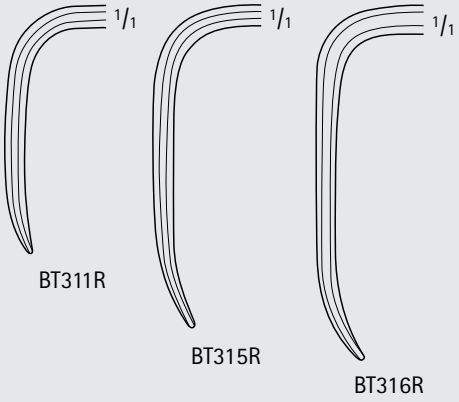

BT311R

BT315R

BT316R

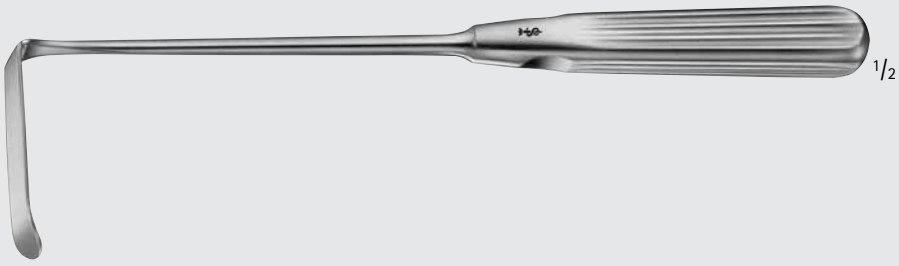

### SAUERBRUCH Retractor

Catalog Number	Blade Size (mm)	Length (in.)
BT351R	46 x 16	8 7/8
BT352R	55 x 22	8 7/8
BT353R	72 x 19	8 7/8

BT351R-BT353R

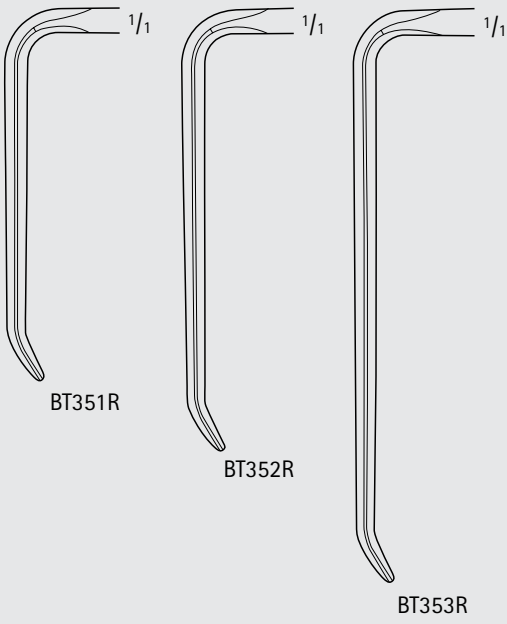

BT351R

BT352R

BT353R

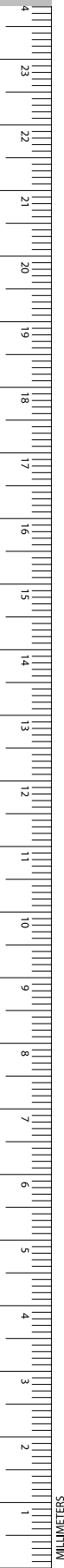



BT354R-BT365R

**KOCHER-LANGENBECK Retractor**

Catalog Number	Blade Size (mm)	Length (in.)
BT354R	25 x 6	8 1/2
BT356R	35 x 8	8 1/2
BT357R	35 x 11	8 1/2
BT358R	35 x 15	8 1/2
BT359R	41 x 11	8 1/2
BT361R	55 x 11	8 1/2
BT363R	70 x 14	8 1/2
BT364R	80 x 12	8 1/2
BT365R	80 x 16	8 1/2



BT354R

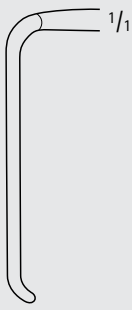

BT356R



BT357R



BT358R



BT359R



BT361R



BT363R



BT364R

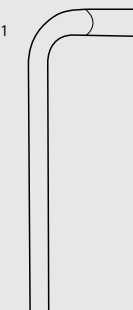

BT365R



MB785R



MB785R

**LAHEY Goiter Retractor**

Catalog Number	Blade Size (mm)	Length (in.)
MB785R	24 x 8	7 7/8



# General Surgery

## Hand Held Retractors



MB748R

### MCBURNEY Thyroid Retractor

Catalog Number	Blade Size (mm)	Length (in.)
MB748R	20 x 10	7 1/2



MB748R



BT404R-BT406R

### MIDDELDORPF Retractor

Catalog Number	Blade Size (mm)	Length (in.)
BT404R	15 x 15	8 3/4
BT405R	20 x 22	8 1/2
BT406R	28 x 28	9 1/4



BT404R

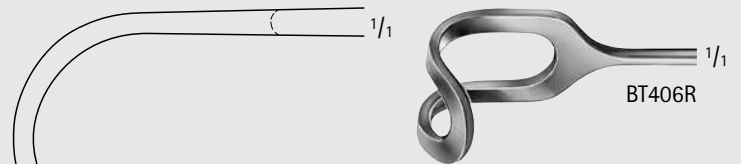

BT406R

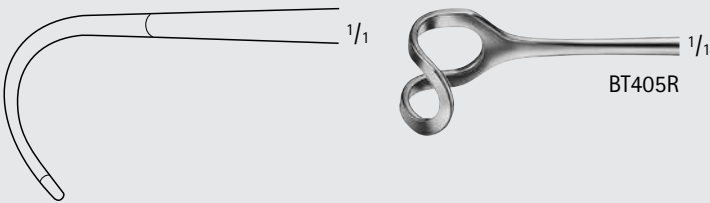

BT405R



BT408R

### GREENE Retractor

Catalog Number	Blade Size (mm)	Length (in.)
BT408R	28 x 22	8 7/8

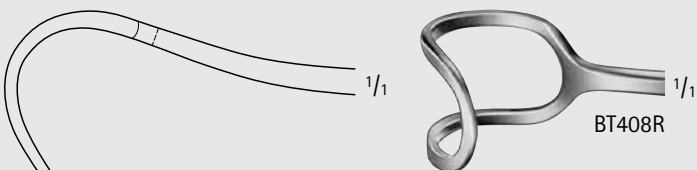

BT408R

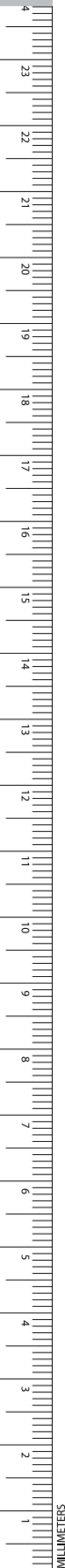

# General Surgery

## Hand Held Retractors

GENERAL  
SURGERY



### DOCKHORN Cheek Retractor

Catalog Number	Blade Size (mm)	Length (in.)
D0438R	40 x 12	8 1/4
D0439R	55 x 14	8 1/4

D0438R-D0439R



D0438R

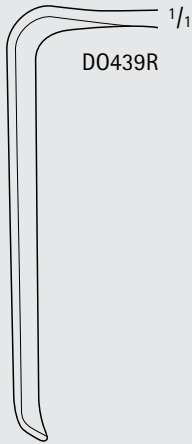

D0439R



INCHES

General Surgery  
Abdominal Retractors

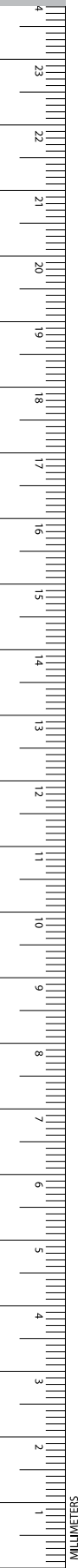

HOESEL Retractor

Catalog Number	Blade Size (mm)	Length (in.)
BT442R	100 x 30	9 3/4
BT446R	220 x 40	9 3/4

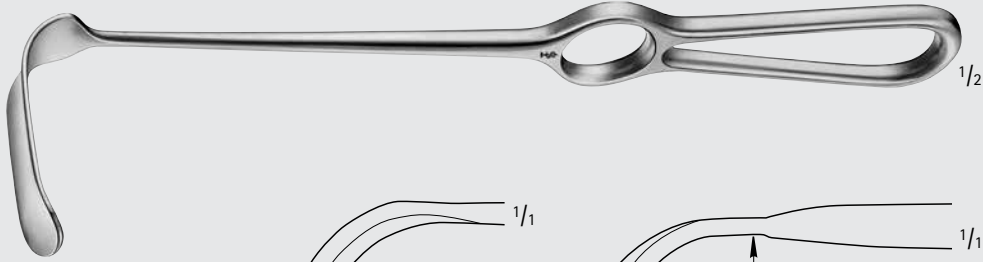

BT442R-BT446R



BT442R

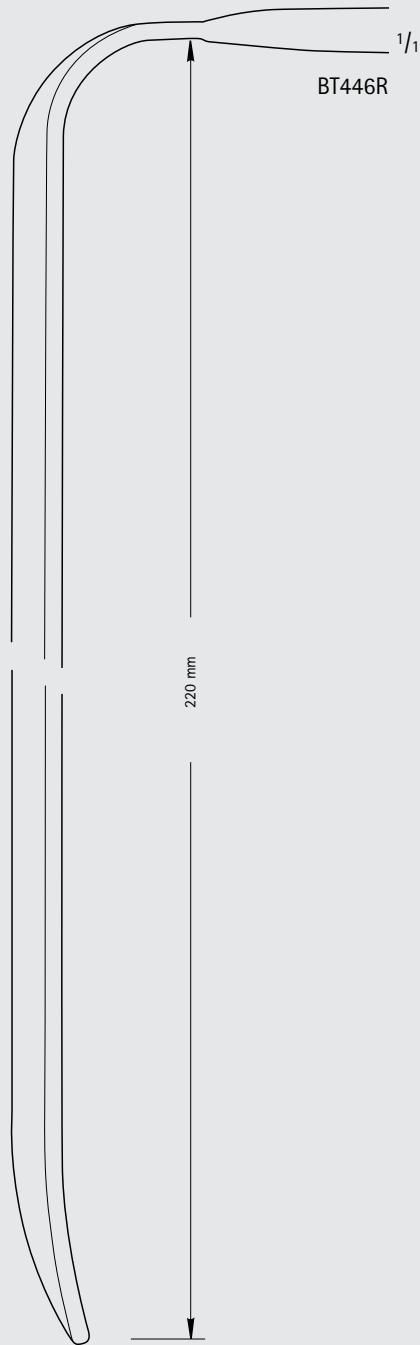

BT446R

220 mm

KOCHER Retractor

Catalog Number	Blade Size (mm)	Length (in.)
BT461R	80 x 42	9 3/4
BT462R	80 x 50	9 3/4
BT463R	80 x 60	9 3/4



BT461R-BT463R

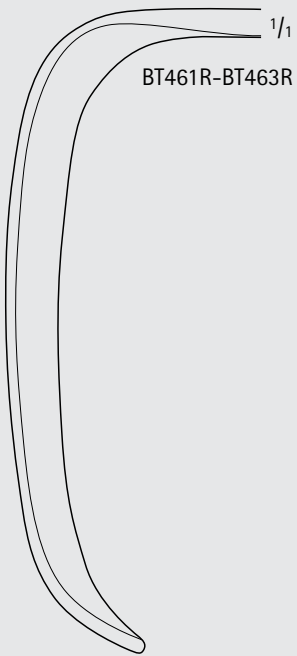

# General Surgery

## Abdominal Retractors



BT464R

1/2

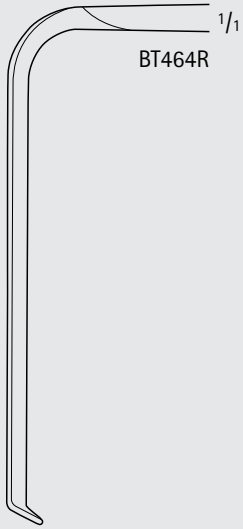

BT464R

1/1

### KRAEMER Retractor

Catalog Number	Blade Size (mm)	Length (in.)
BT464R	66 x 10	8 1/4



BT465R

1/2



BT465R

1/1

### CASPAR Retractor

Catalog Number	Blade Size (mm)	Length (in.)
BT465R	67 x 17	8 1/4



BT450R-BT469R

**MIASPAS® Mini ALIF LANGENBECK Retractor**

Catalog Number	Blade Size (mm)	Length (in.)
BT450R	125 x 20	8 1/4
BT451R	125 x 35	8 1/4
BT466R	80 x 20	8 1/4
BT467R	110 x 20	8 1/4
BT468R	80 x 35	8 1/4
BT469R	110 x 35	8 1/4

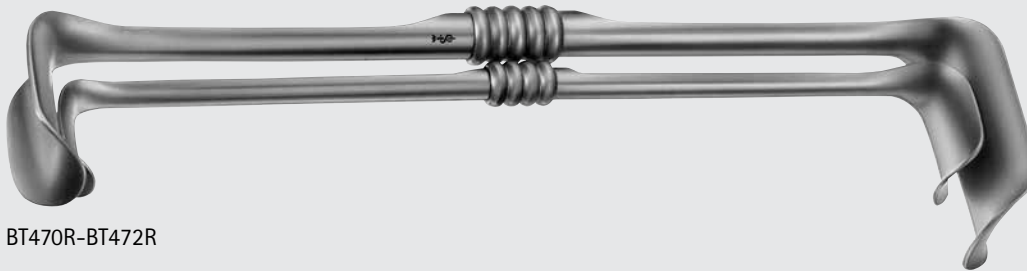

BT470R-BT472R

**RICHARDSON-EASTMAN Retractor**

Catalog Number	Description	Tip	Length (in.)
BT470R	2/SET (BT471R, BT472R)	-	-
BT471R	-	SM	9 3/4
BT472R	-	LRG	10 5/8

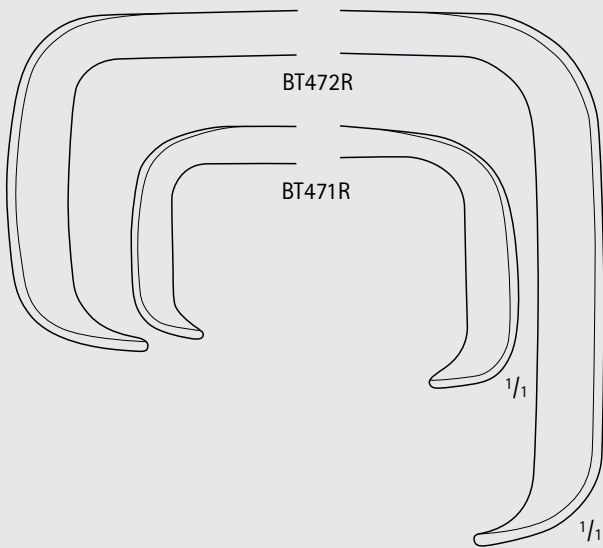

# General Surgery

## Abdominal Retractors



BT475R-BT477R

### RICHARDSON Retractor

Catalog Number	Blade Size (mm)	Blade Size (in.)	Length (in.)
BT475R	23 x 20	1 x 3/4	9 1/2
BT476R	30 x 29	1 1/4 x 1 1/8	9 1/2
BT477R	37 x 37	1 1/2 x 1 1/2	9 1/2
BT478R	47 x 21	2 x 3/4	9 1/2

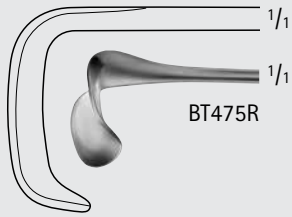

BT475R

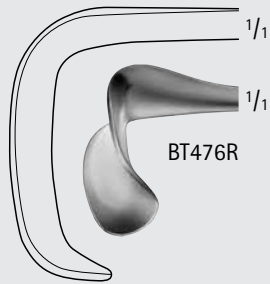

BT476R

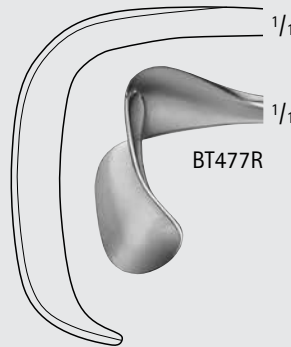

BT477R



BT478R

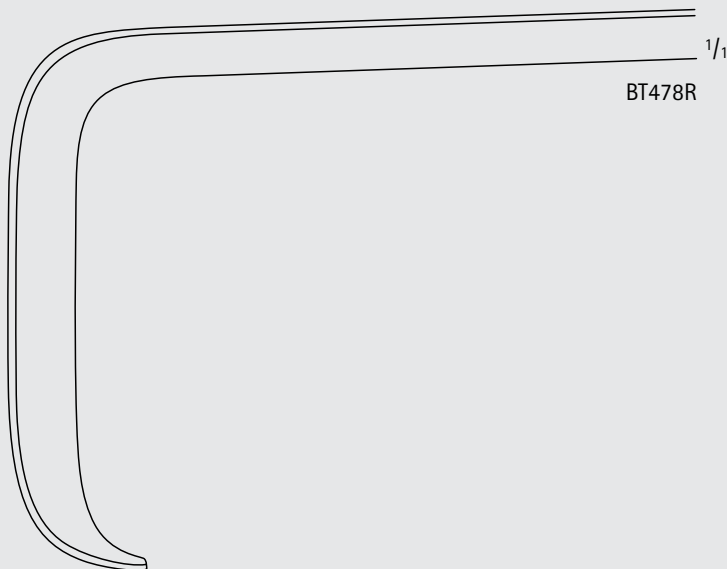

BT478R

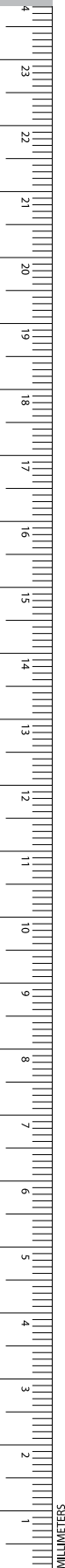

# General Surgery

## Abdominal Retractors

### RICHARDSON Retractor

Catalog Number	Blade Size (mm)	Blade Size (in.)	Length (in.)
BT479R	65 x 41	2 1/2 x 1 5/8	9 3/4

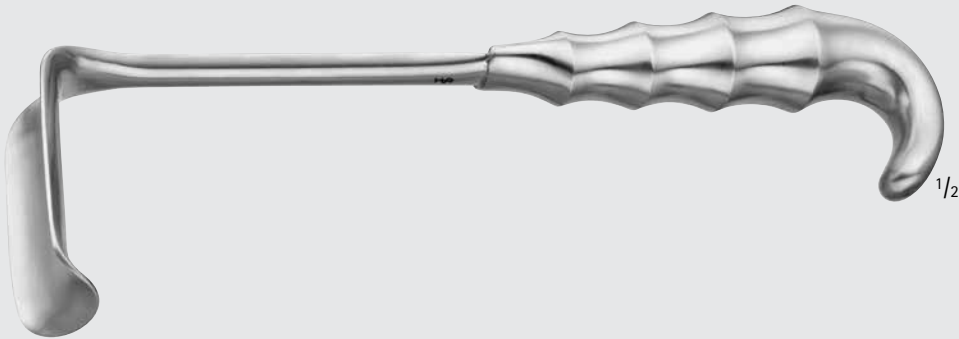

BT479R

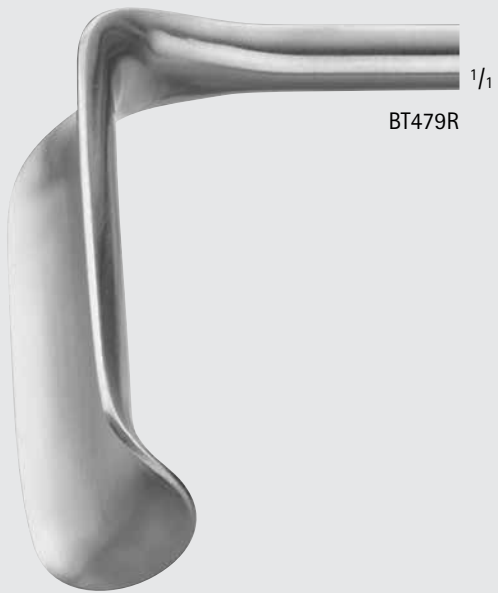

BT479R



General Surgery  
Abdominal Retractors

KELLY Retractor

Catalog Number	Blade Size (mm)	Blade Size (in.)	Length (in.)
BT481R	50 x 40	2 x 1 1/2	10 1/4
BT482R	64 x 54	2 1/2 x 2	10 1/4
BT483R	70 x 65	2 3/4 x 2 1/2	10 1/4
BT484R	90 x 76	3 1/2 x 3	10 1/4

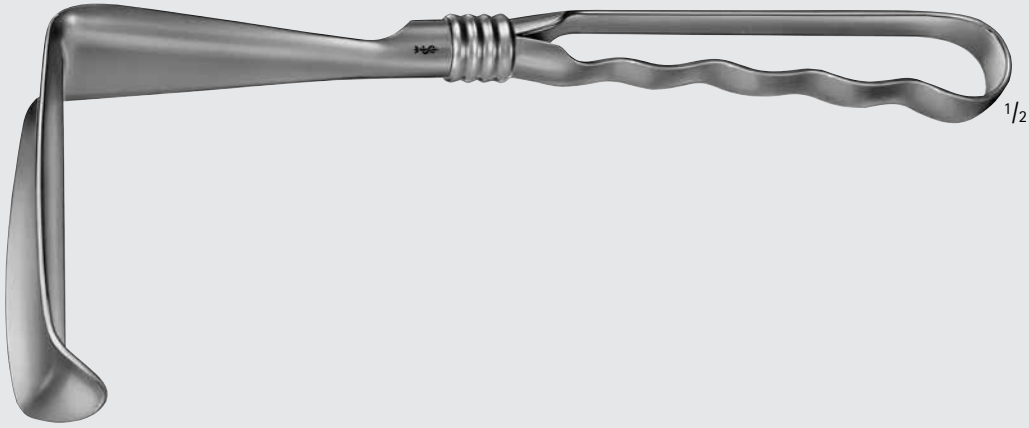

BT481R-BT484R



BT481R

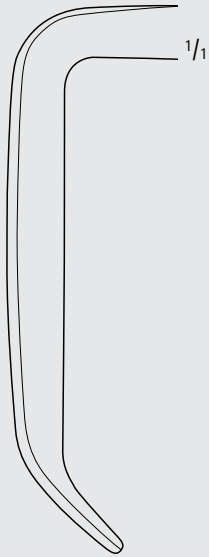

BT482R

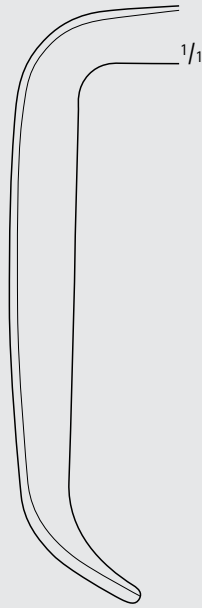

BT483R

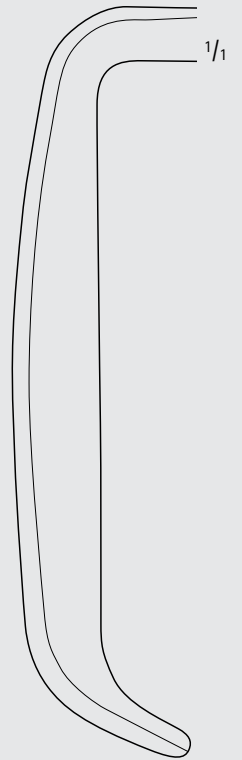

BT484R

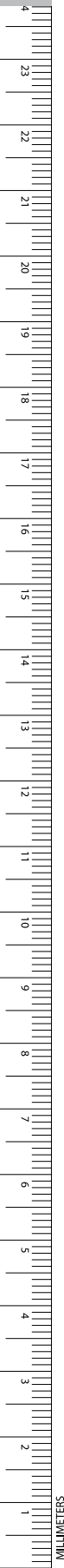

# General Surgery

## Abdominal Retractors

SAUERBRUCH Retractor, Open

Catalog Number	Blade Size (mm)	Length (in.)
BT514R	130 x 38	10 1/4

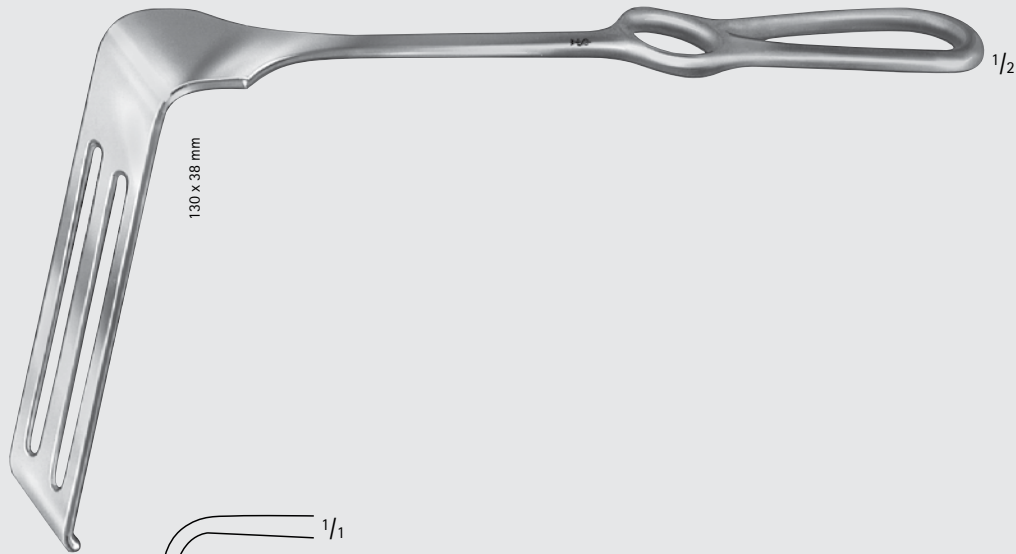

BT514R



BT514R



INCHES

General Surgery  
Abdominal Retractors

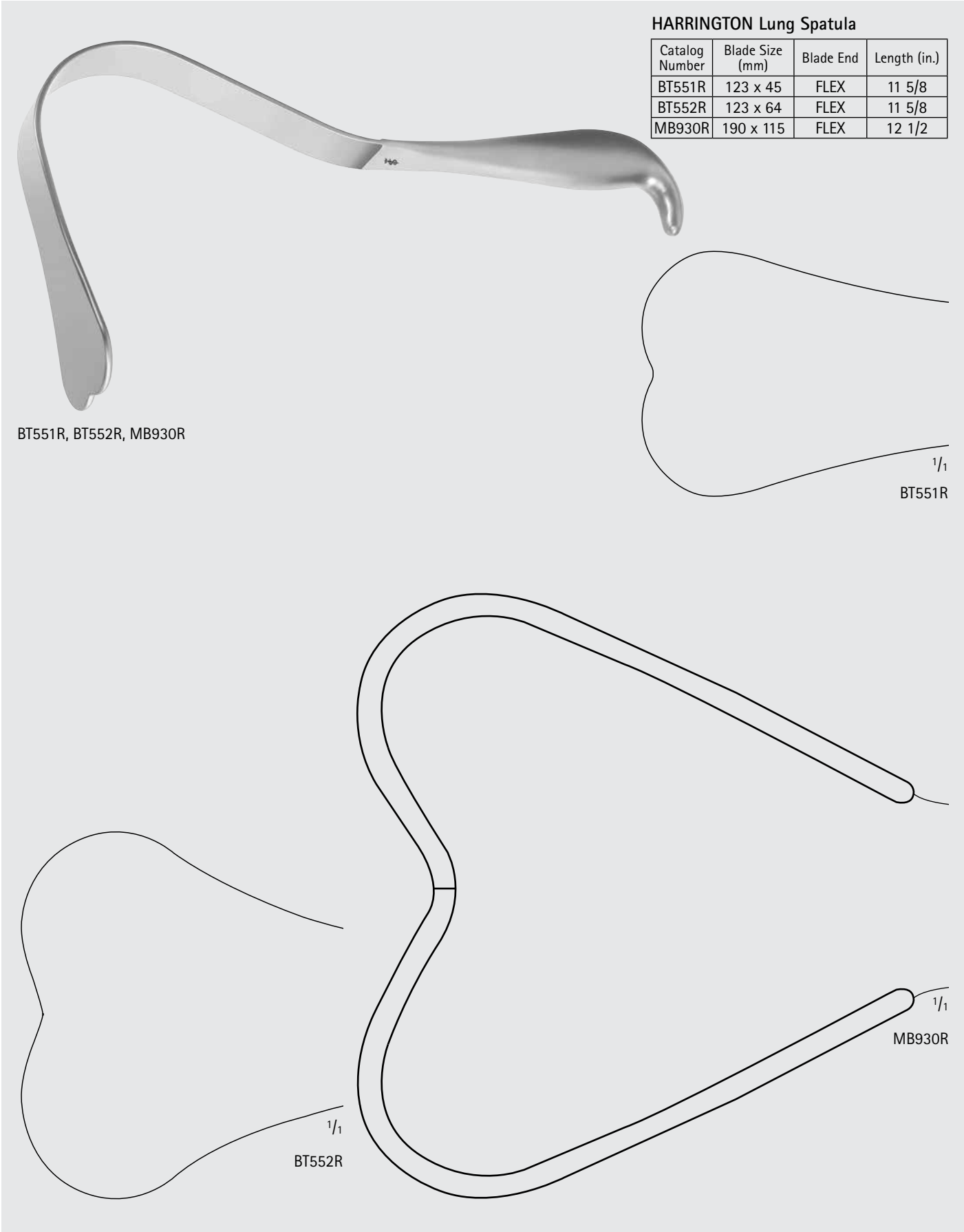

HARRINGTON Lung Spatula

Catalog Number	Blade Size (mm)	Blade End	Length (in.)
BT551R	123 x 45	FLEX	11 5/8
BT552R	123 x 64	FLEX	11 5/8
MB930R	190 x 115	FLEX	12 1/2

BT551R, BT552R, MB930R

1/1  
BT551R

1/1  
BT552R

1/1  
MB930R

# General Surgery

## Abdominal Retractors

HARRINGTON Retractor, Large Blade

Catalog Number	Blade Size (mm)	Blade End	Length (in.)
MG472R	195 x 115	FLEX	14 3/8



MG472R

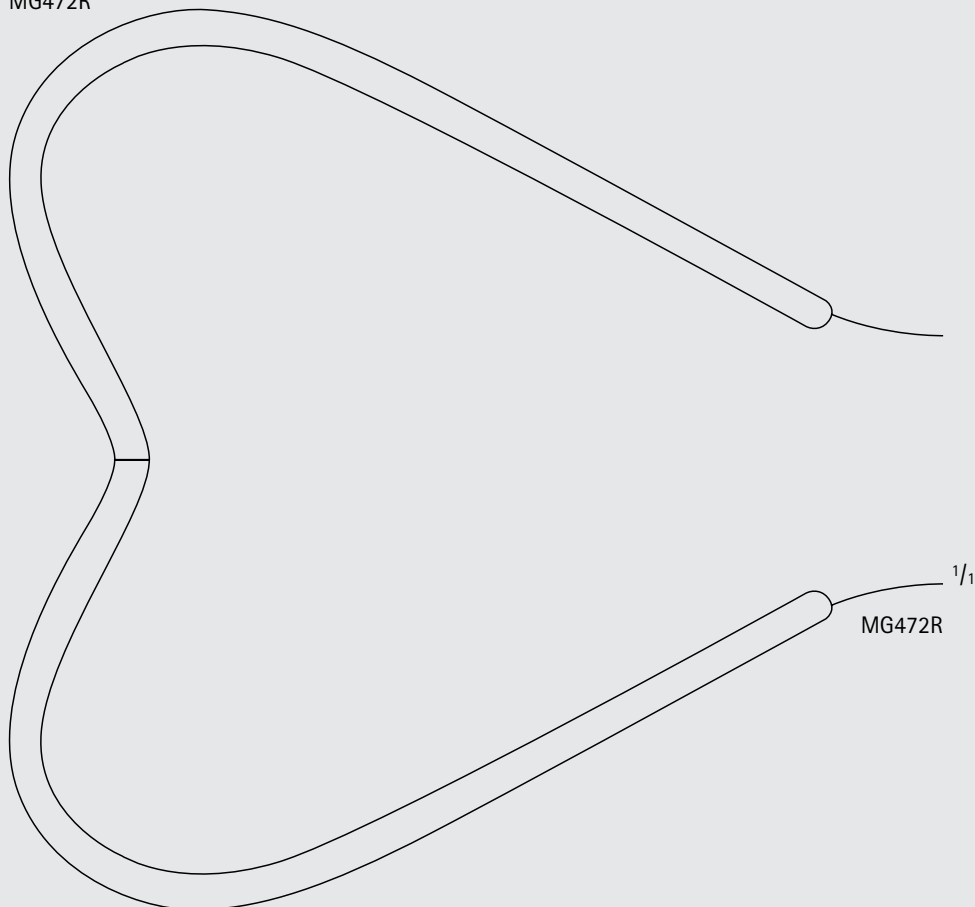

INCHES

General Surgery  
Abdominal Retractors

HARRINGTON-PEMBERTON Lung  
Spatula

Catalog Number	Blade Size (mm)	Blade End	Length (in.)
BT553R	175 x 64	FLEX	11 5/8

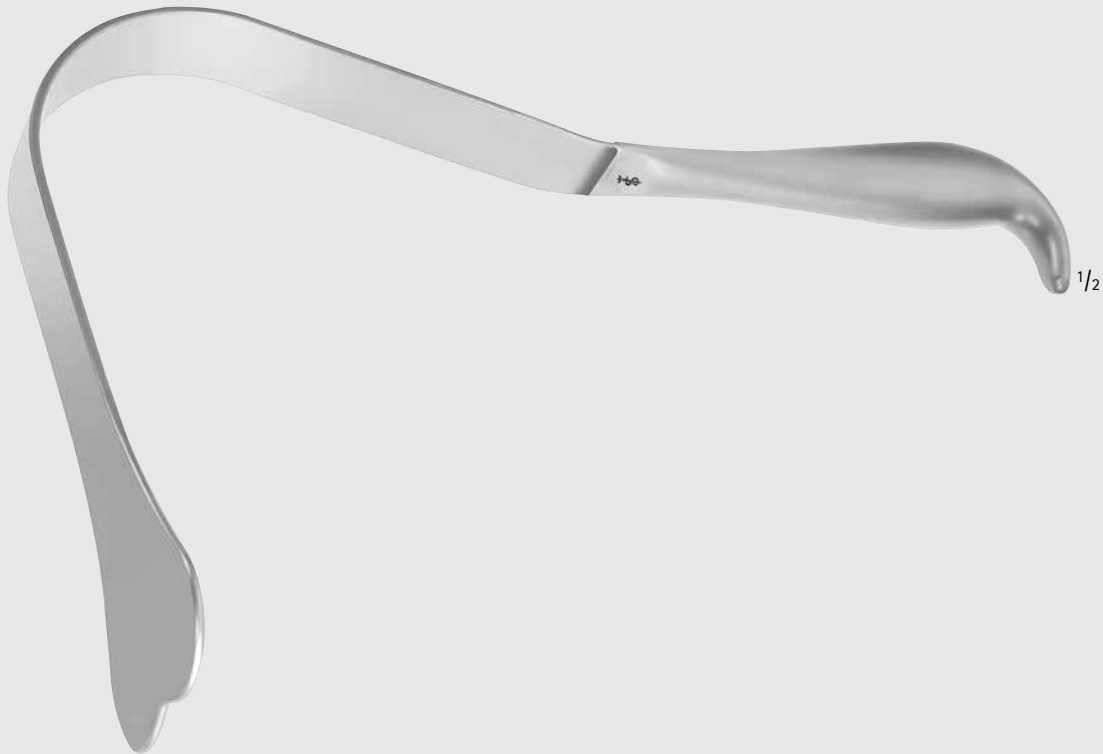

BT553R

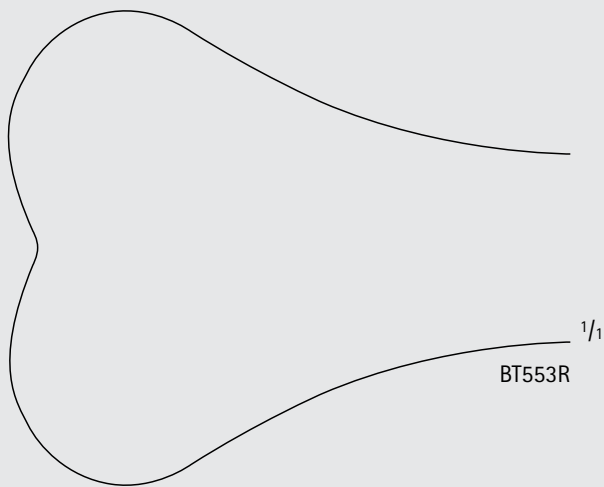

BT553R

1/i

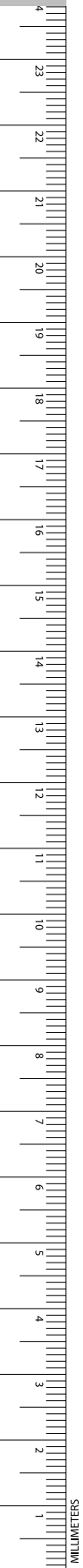

ZENKER Retractor

Catalog Number	Blade Size (mm)	Length (in.)
BT594R	36 x 8	9 1/2
BT595R	60 x 12	10
BT596R	75 x 12	10 5/8
BT597R	120 x 12	11 1/2



BT594R-BT597R

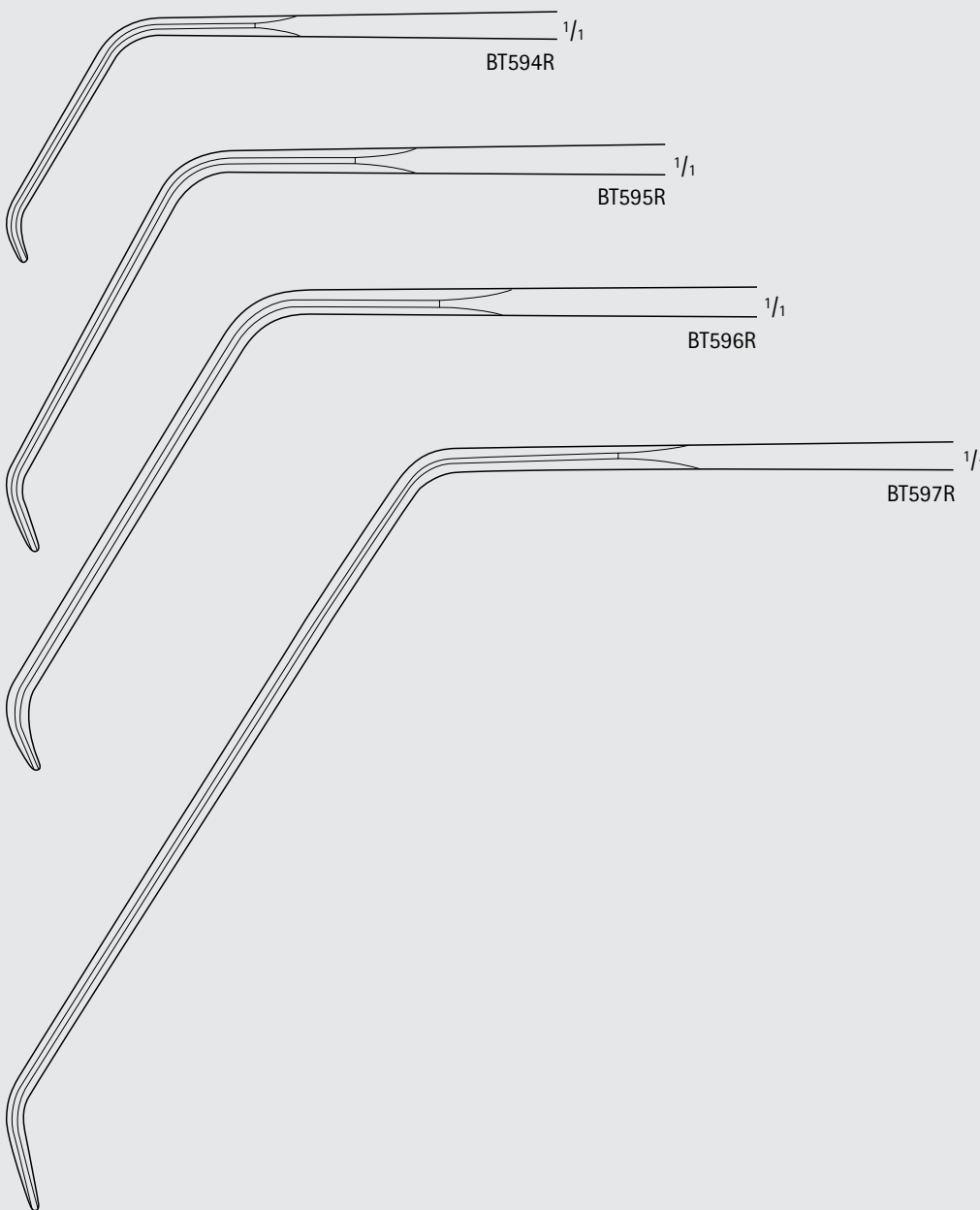

INCHES

# General Surgery

## Abdominal Retractors



BT600R



BT600R

### DEAVER Retractor

Catalog Number	Blade Size (mm)	Blade Size (in.)	Length (in.)
BT600R	19	3/4	7

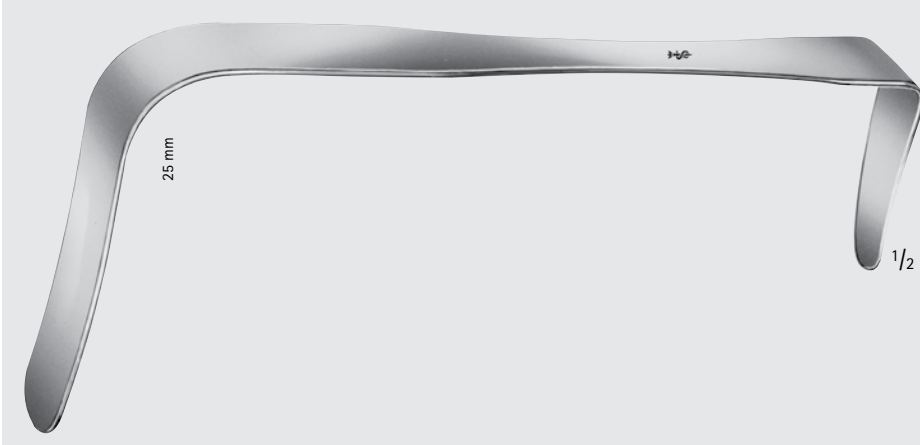

BT606R

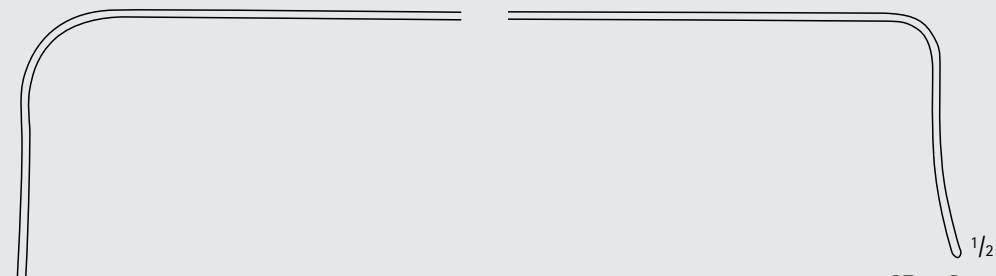

BT606R

### DEAVER Retractor, Double Ended

Catalog Number	Blade Size (mm)	Blade Size (in.)	Length (in.)
BT606R	25	1	9 1/4

DEAVER Retractor

Catalog Number	Blade Size (mm)	Blade Size (in.)	Length (in.)
BT601R	22	7/8	8 1/2
BT602R	25	1	11 3/4
BT603R	25	1	12 3/8



BT601R

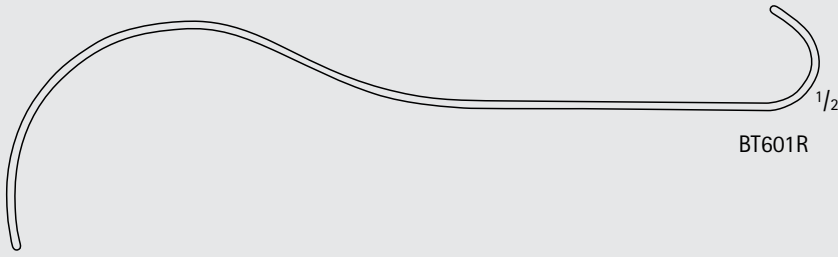

BT601R



BT602R-BT603R



BT602R

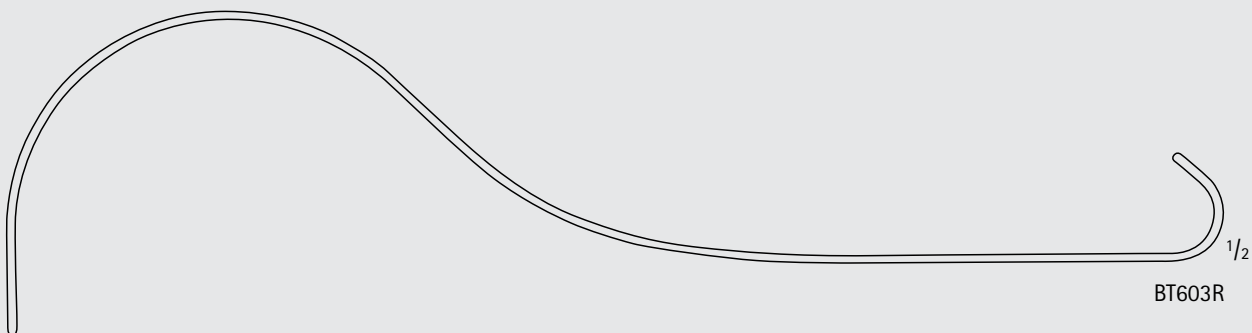

BT603R



INCHES

General Surgery  
Abdominal Retractors



DEAVER Retractor  
(continued)

Catalog Number	Blade Size (mm)	Blade Size (in.)	Length (in.)
BT604R	38	1 1/2	11 3/4



BT604R

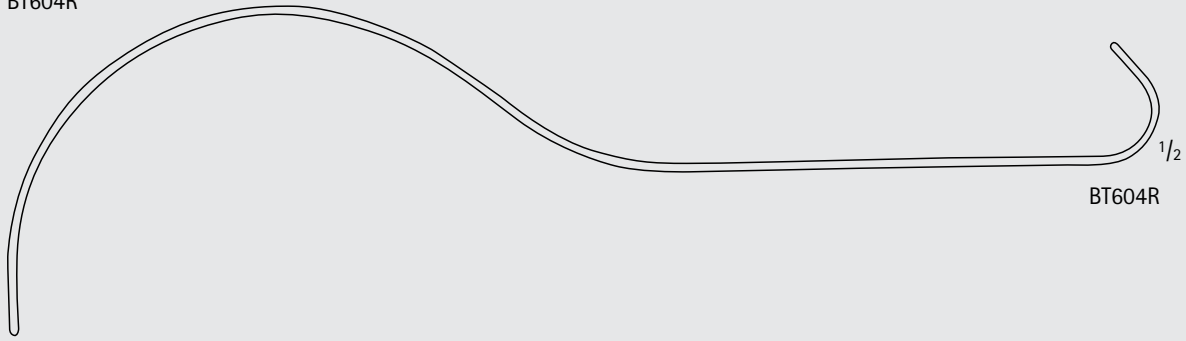

BT604R

DEAVER Retractor  
(continued)

Catalog Number	Blade Size (mm)	Blade Size (in.)	Length (in.)
BT605R	50	2	12 1/4
BT607R	25	1	14 3/8

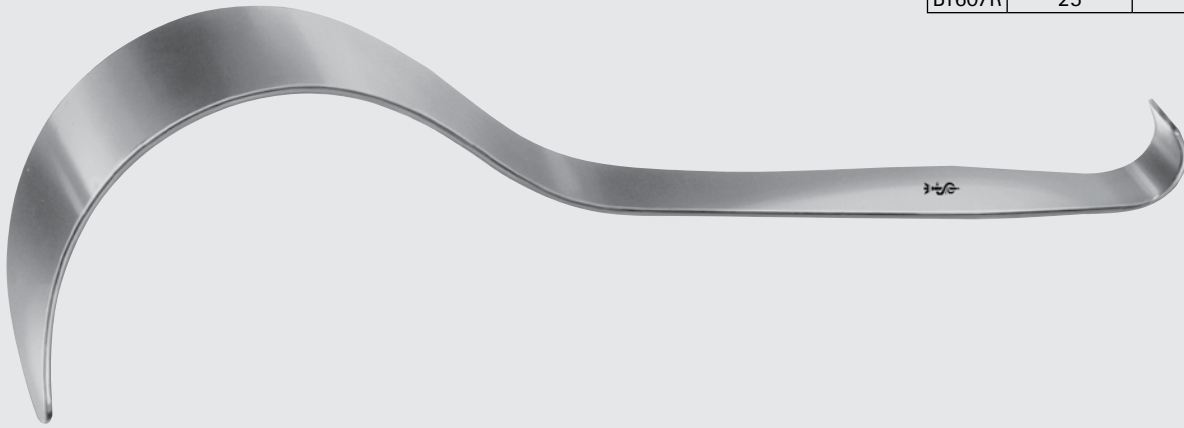

BT605R-BT607R

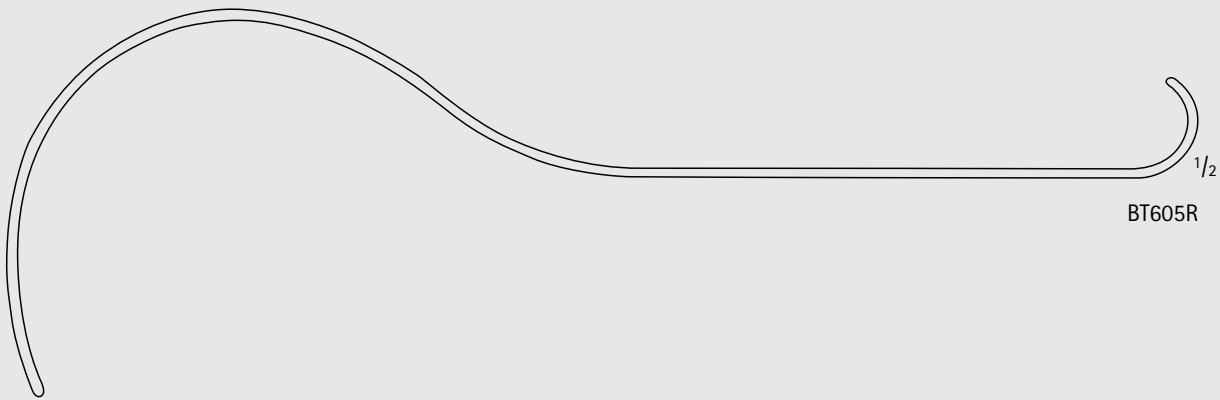

BT605R

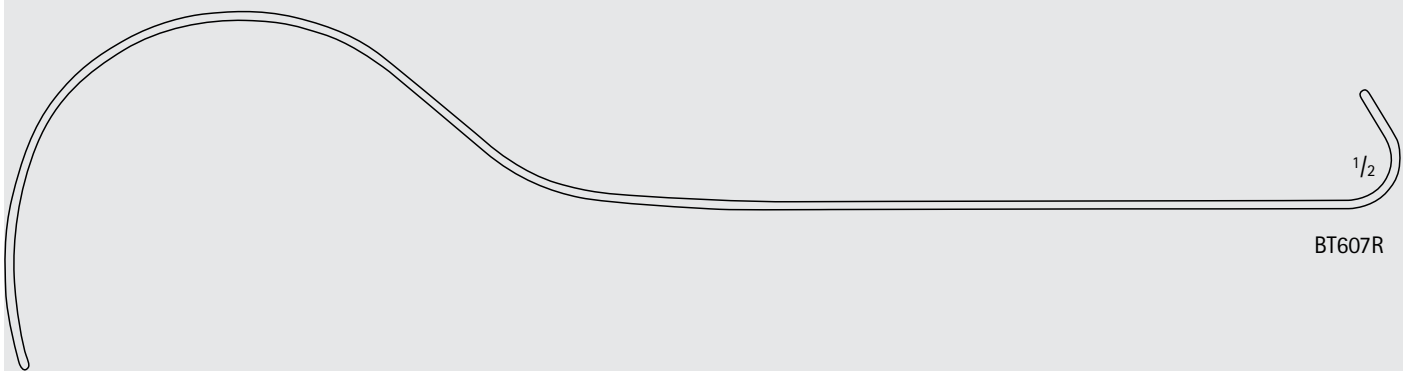

BT607R



INCHES

General Surgery  
Abdominal Retractors

DEAVER Retractor  
(continued)

Catalog Number	Blade Size (mm)	Blade Size (in.)	Length (in.)
BT608R	75	3	12 1/2

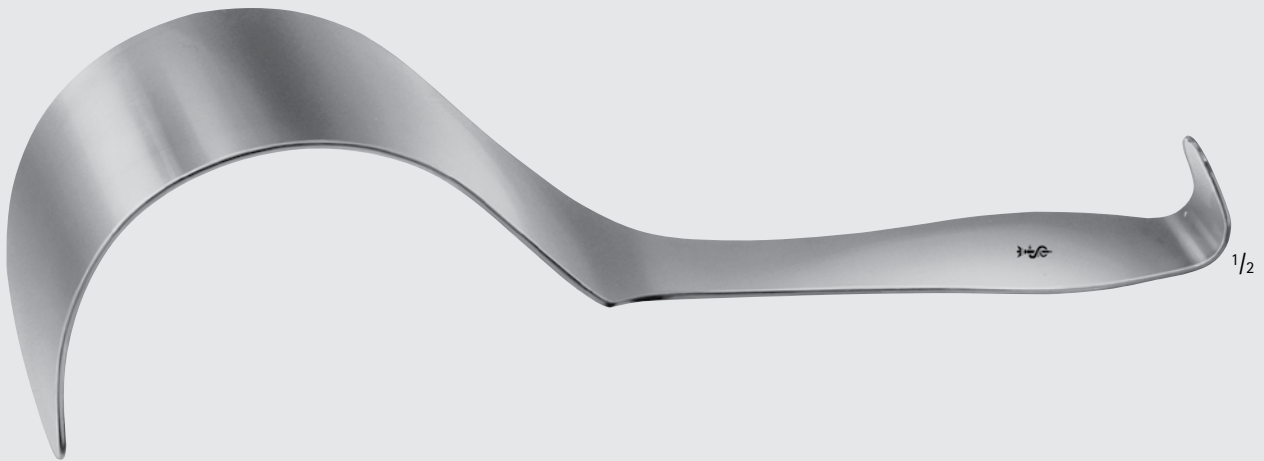

BT608R

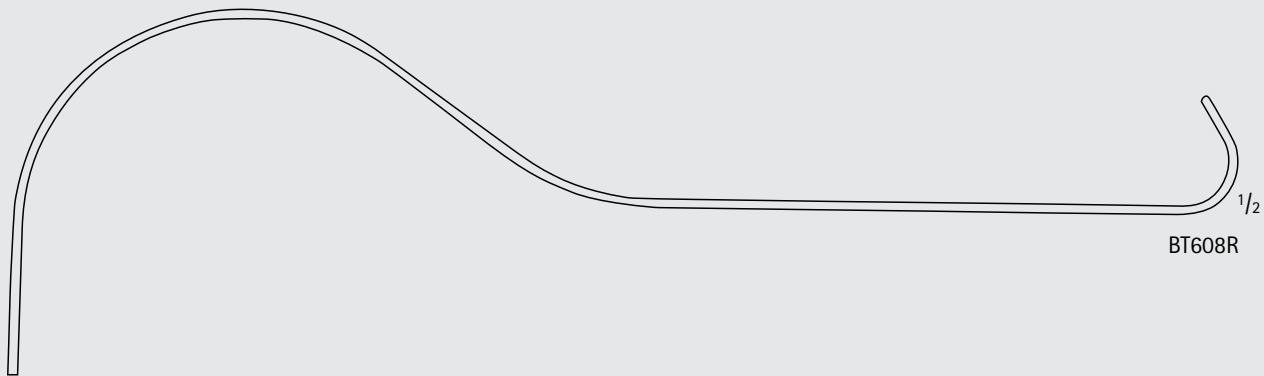

BT608R

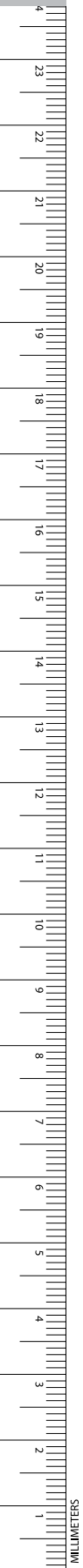

DEAVER Retractor, W/ Grip

Catalog Number	Blade Size (mm)	Blade Size (in.)	Length (in.)
BT611R	25	1	12 1/4
BT613R	38	1 1/2	12 1/4
BT614R	50	2	12
BT615R	75	3	12 1/4



BT611R-BT615R

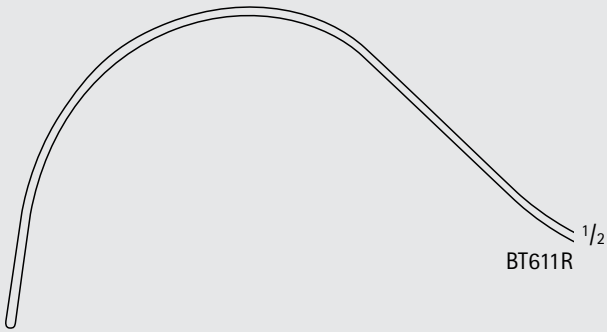

BT611R

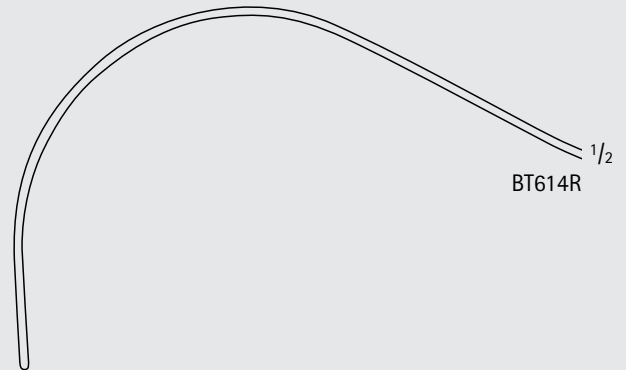

BT614R

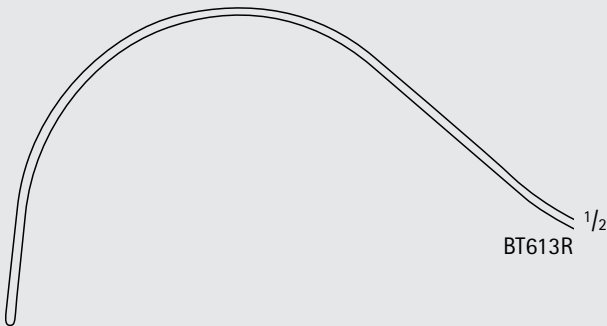

BT613R

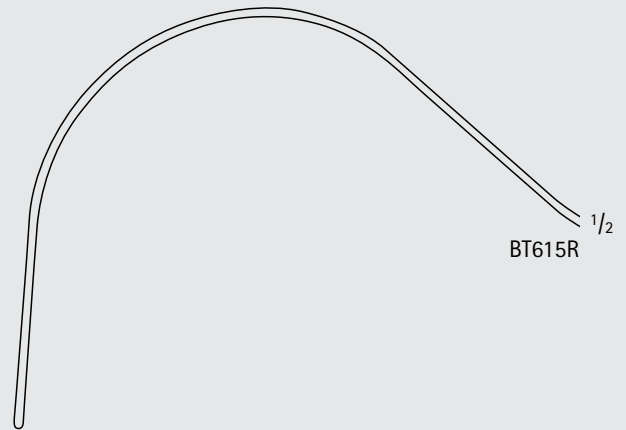

BT615R



# General Surgery

## Abdominal Retractors

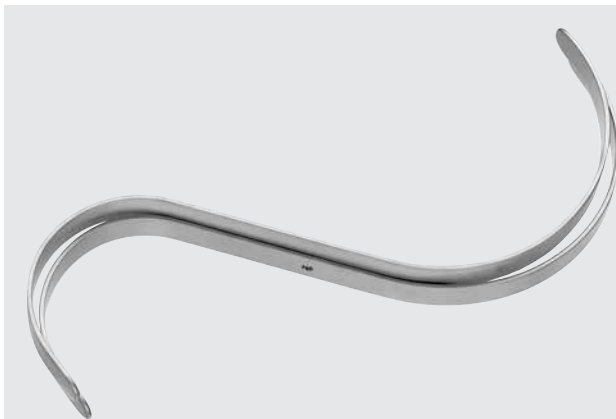

MD071R-MD076

### HASSON "S" Retractor, 2/Set

Catalog Number	Blade	Blade Size (mm)	Length (in.)
MD076	MALLEABLE	10	6 1/4
MD077	MALLEABLE	13	7
MD071R	RIGID	10	7 1/8
MD072R	RIGID	13	7 1/8

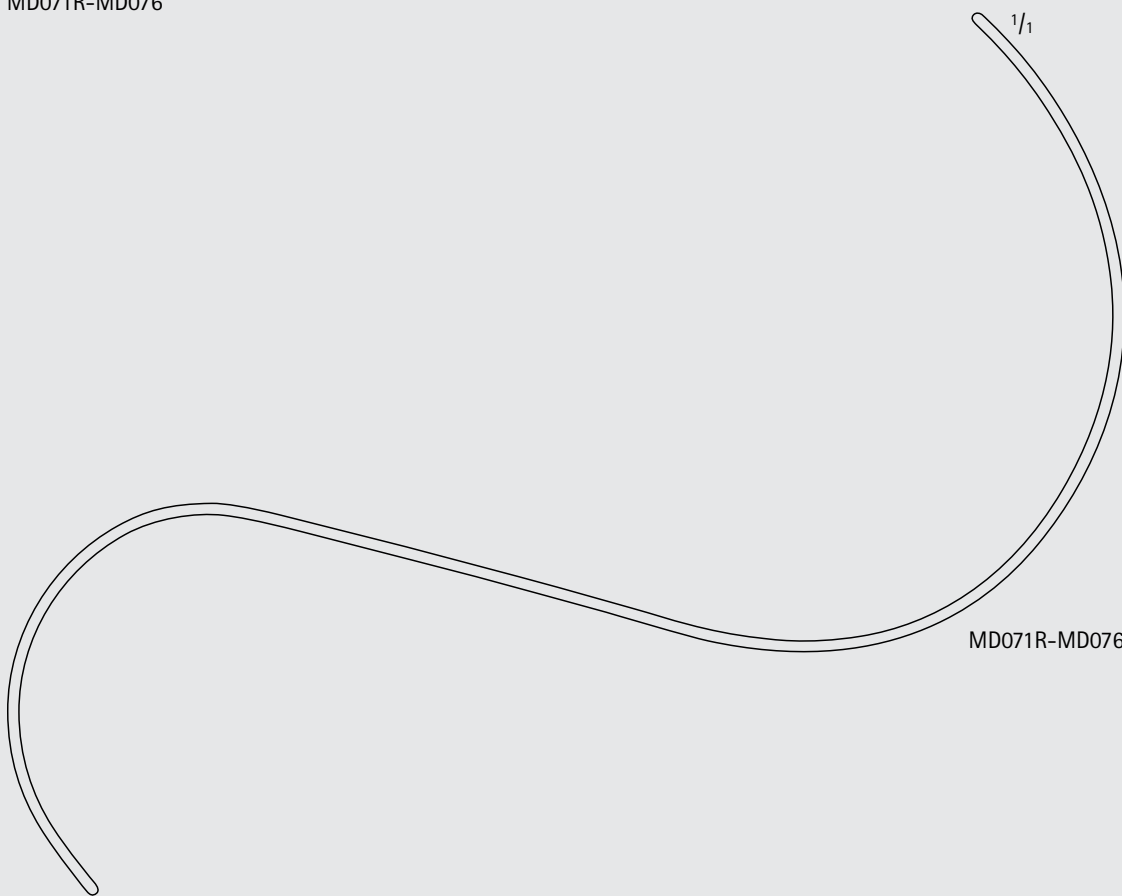

MD071R-MD076



BT750R

**TUFFIER Spatula, Malleable**

Catalog Number	Blade Size (mm)	Blade Size (in.)	Length (in.)
BT750R	17 / 25	3/4 / 1	7 7/8



BT751R-BT763R, MD498, MG480R-MG484R

**Ribbon Spatula, Malleable**

Catalog Number	Blade Size (mm)	Blade Size (in.)	Length (in.)
MG480R	5	1/8	8
BT751R	12	1/2	7 7/8
BT752R	17	3/4	7 7/8
MG481R	25	1	8
BT755R	25	1	9 3/4
MD498	75	3	13
MG482R	20	3/4	13
BT756R	25	1	13
BT761R	30	1 1/4	13
BT762R	40	1 1/2	13
BT763R	50	2	13
MG483R	65	2 1/2	13
MG484R	100	4	13



BT758R

**HABERER Spatula, Malleable**

Catalog Number	Blade Size (mm)	Blade Size (in.)	Length (in.)
BT758R	40 / 50	1 1/2 / 2	12



MG374R



MG374R

**Spatula and Packer, Double Ended**

Catalog Number	Length (in.)
MG374R	5 3/4



INCHES

General Surgery  
Abdominal Retractors

DOYEN Abdominal Retractor

Catalog Number	Blade Size (mm)	Length (in.)
BT667R	53 x 80	9 3/4
BT669R	72 x 82	10 1/4



BT667R



BT669R

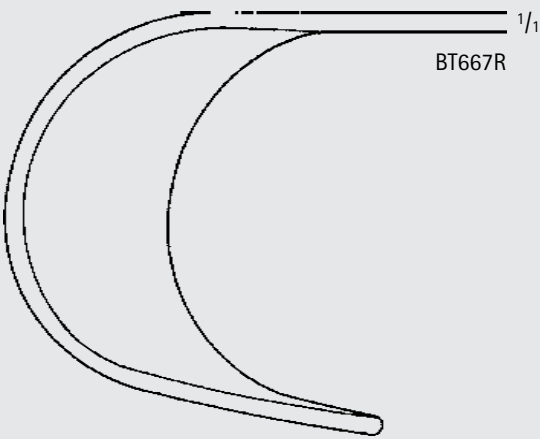

BT667R

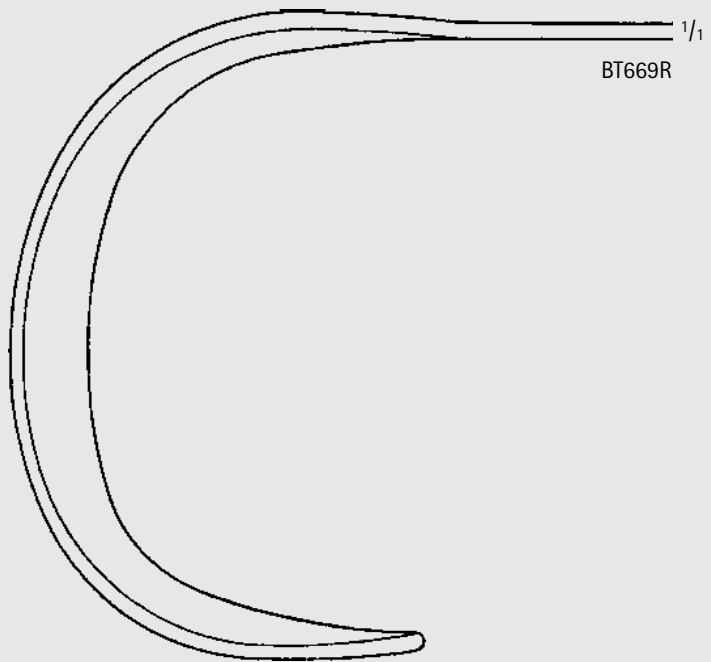

BT669R

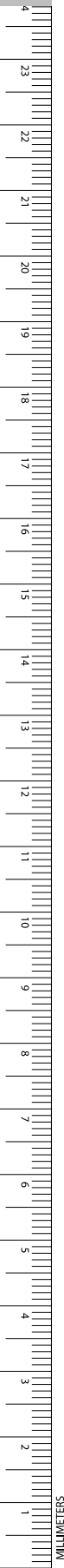

# General Surgery

## Abdominal Retractors

GENERAL  
SURGERY

### WEINBERG Vagotomy Retractor, Joe's Hoe

Catalog Number	Blade Size (mm)	Length (in.)
MG491R	47 x 57 / 93 x 157	9



MG491R



# General Surgery

## Abdominal Retractors

ST. MARKS Pelvis Retractor

Catalog Number	Blade Size (mm)	Length (in.)
BT670R	124 x 60	11 1/2
BT672R	174 x 60	13

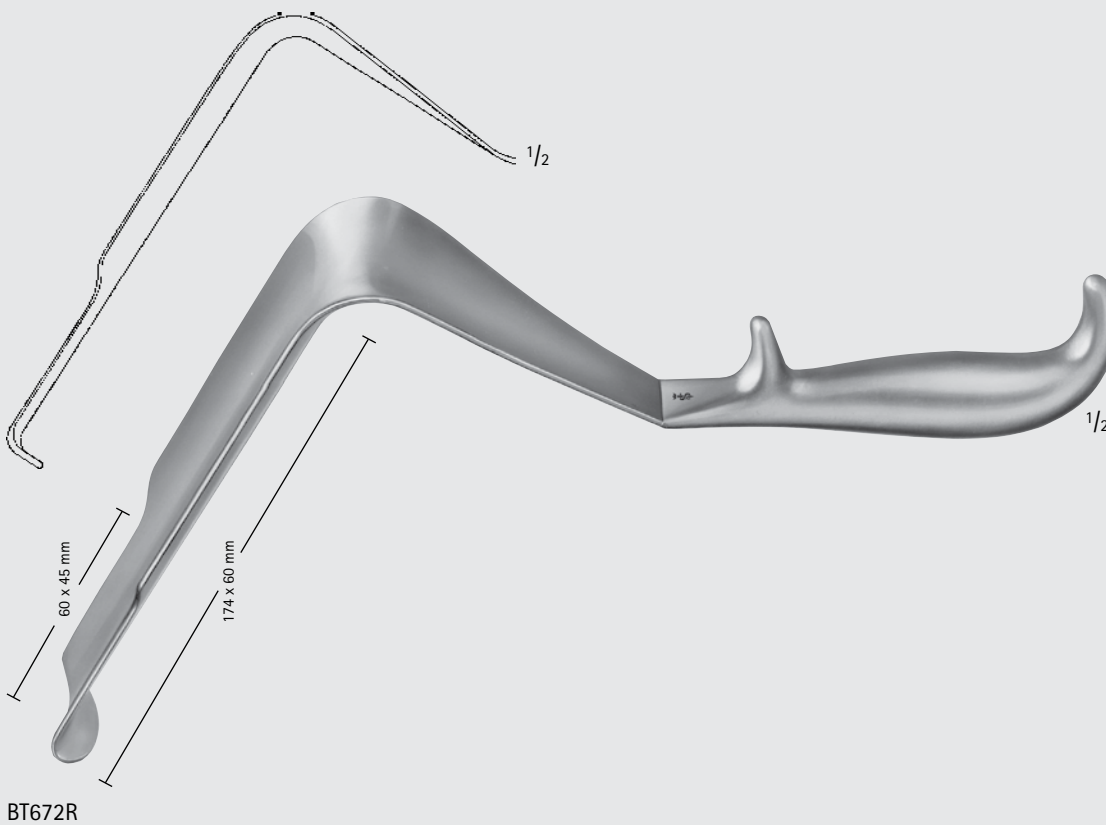
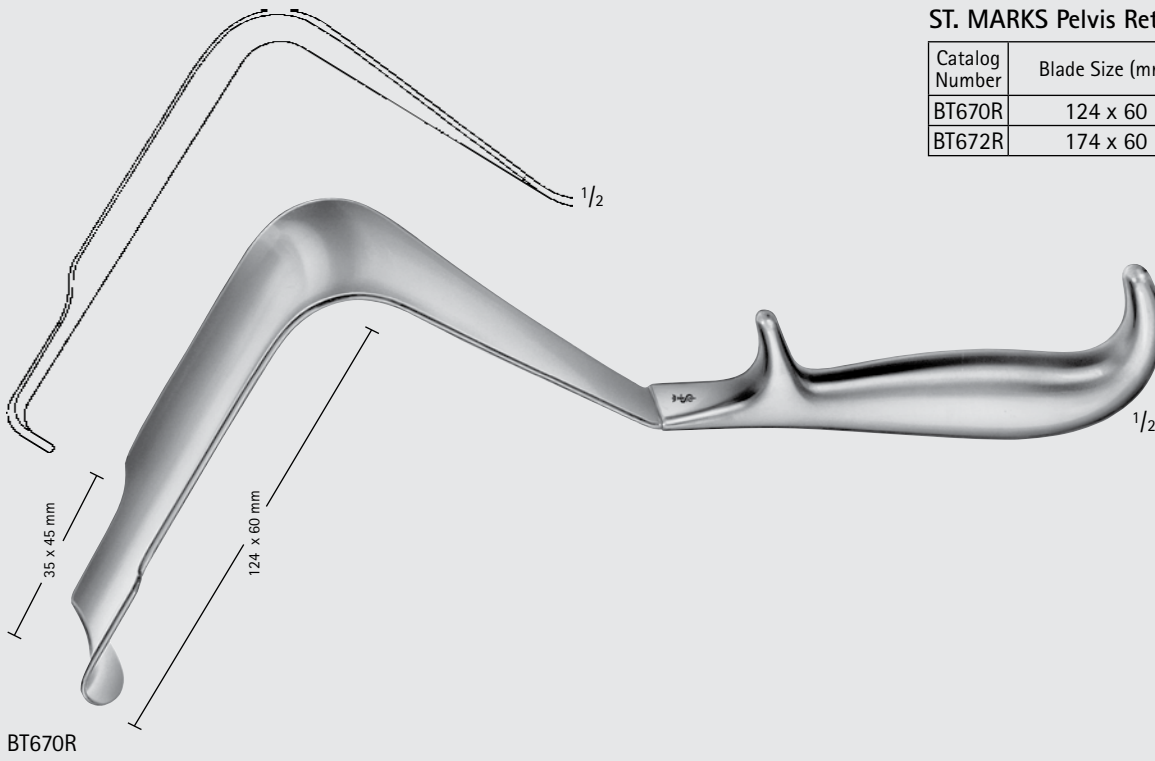

ST. MARKS Pelvis Retractor  
(continued)

Catalog Number	Blade Size (mm)	Length (in.)
BT674R	178 x 60	13

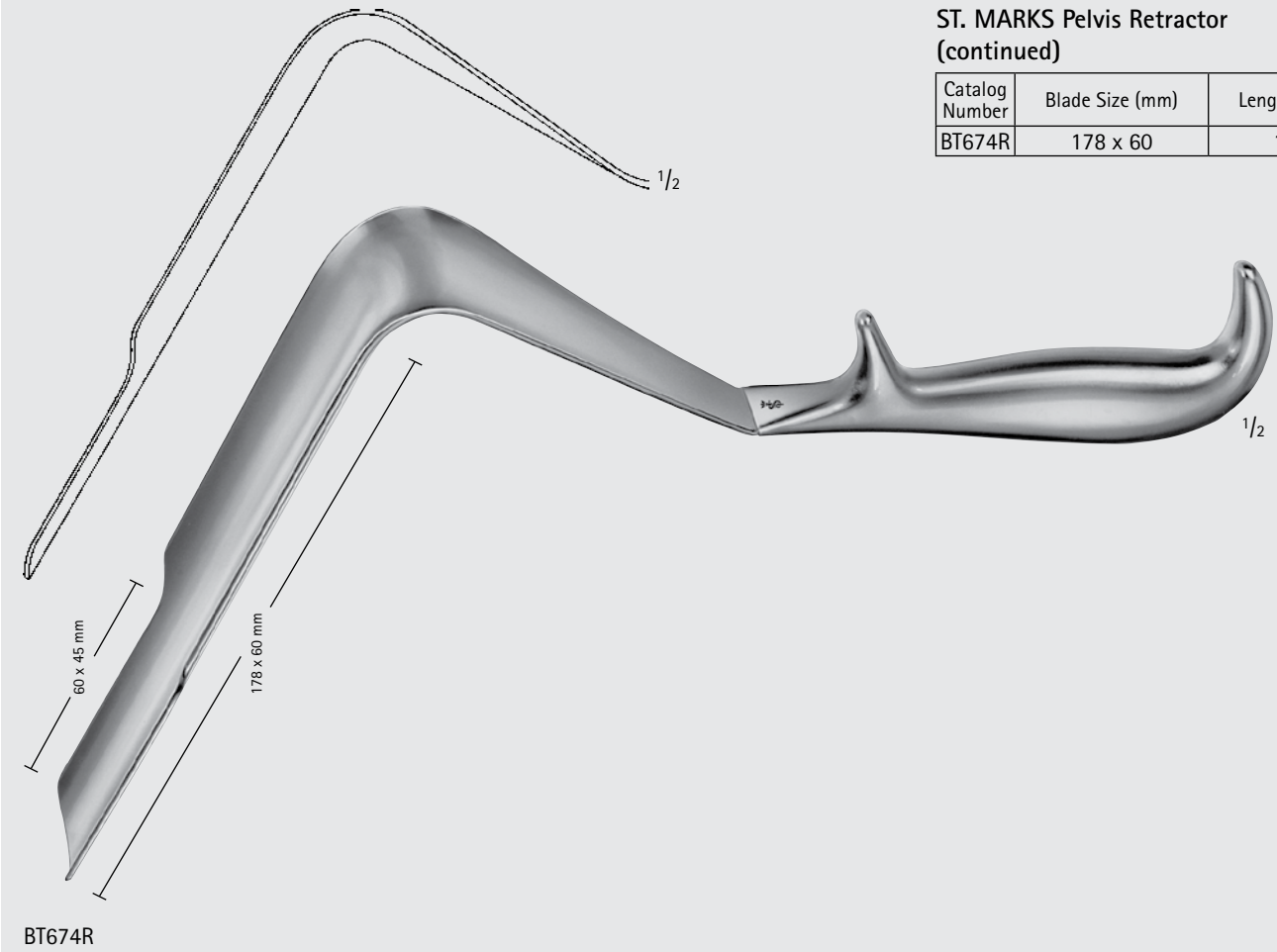

General Surgery  
Abdominal Retractors

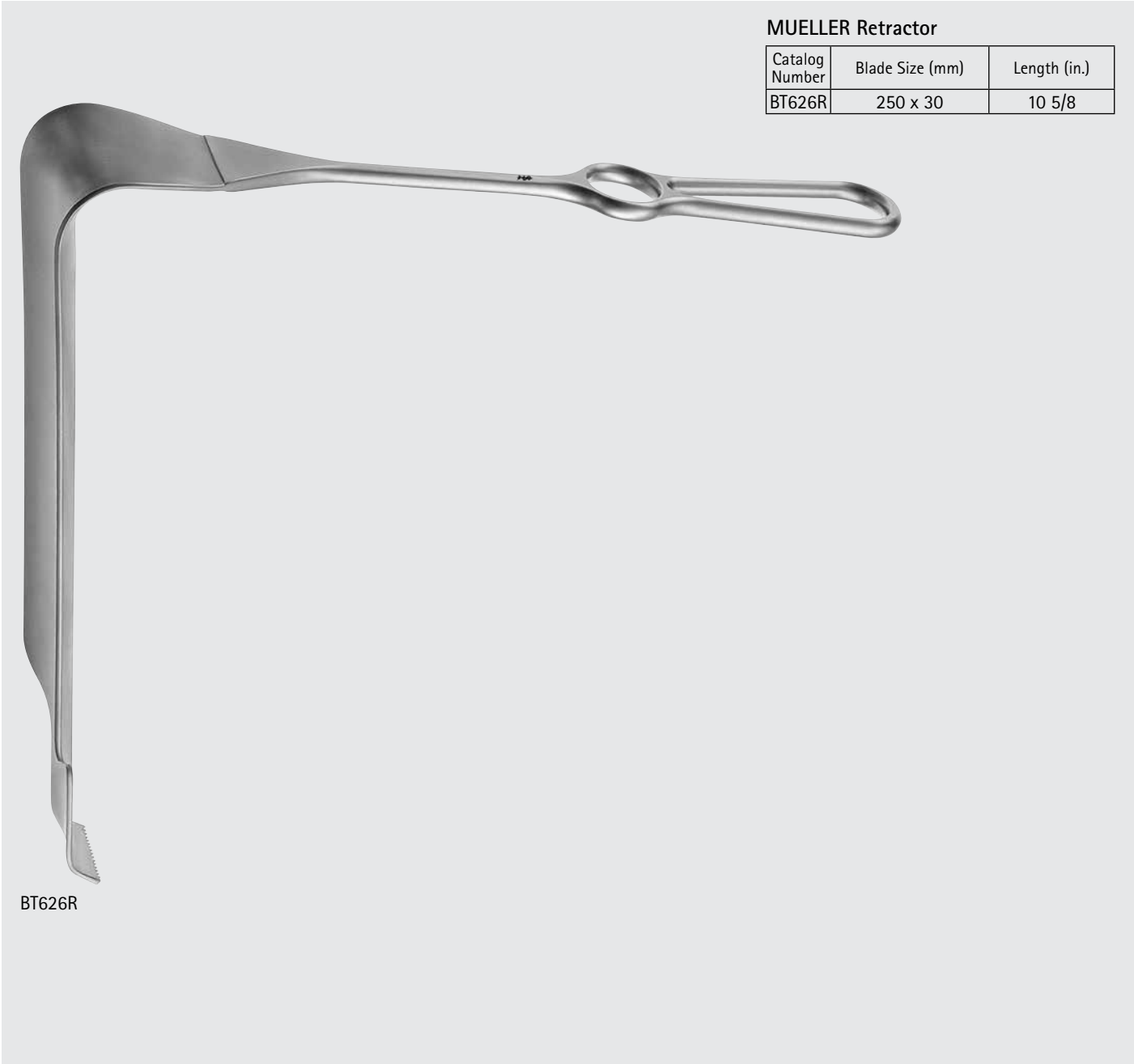

MUELLER Retractor

Catalog Number	Blade Size (mm)	Length (in.)
BT626R	250 x 30	10 5/8

BT626R



MAYO-COLLINS Appendectomy Retractor

Catalog Number	Length (in.)
MB129R	6 3/4

MB129R

1/2

# General Surgery

## Abdominal Retractors

### ROCHARD Retractor Mounting Frame, F/ BT711R-BT715R

Catalog Number	Mounting Arms
BT708R	DOUBLE
BT709R	SINGLE

Mounting frame for fastening to the lateral bars of the operating tables, can be dismantled for decontamination and sterilization.

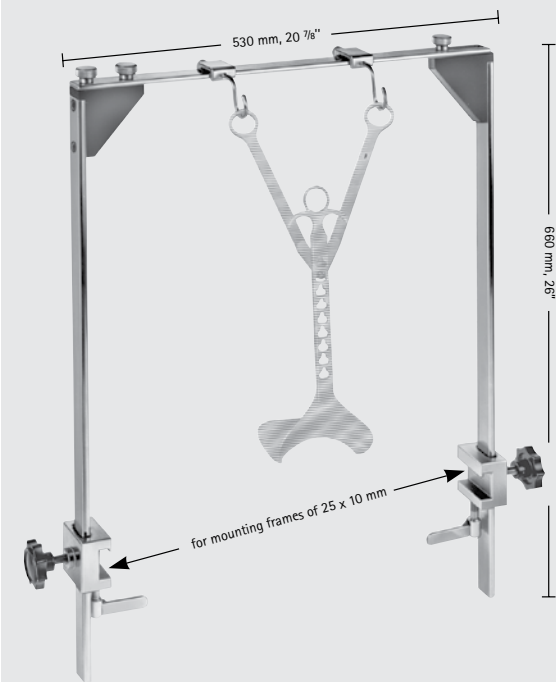

BT708R-BT709R

### ROCHARD Fixation Device, F/ BT711R-BT715R

Catalog Number	Length (mm)	Length (in.)
BT710R	190	7 1/2

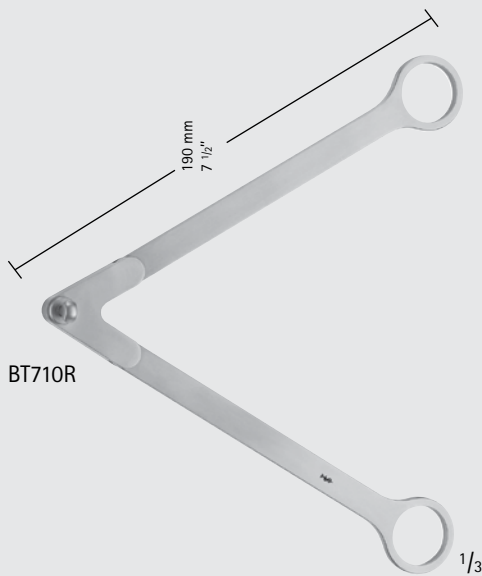

BT710R

### ROCHARD Blades

Catalog Number	Blade Size (mm)	Length (in.)
BT711R	48 x 90	12 1/4
BT712R	48 x 105	12 1/4
BT713R	48 x 120	12 1/4
BT714R	48 x 135	12 1/4
BT715R	48 x 155	12 1/4

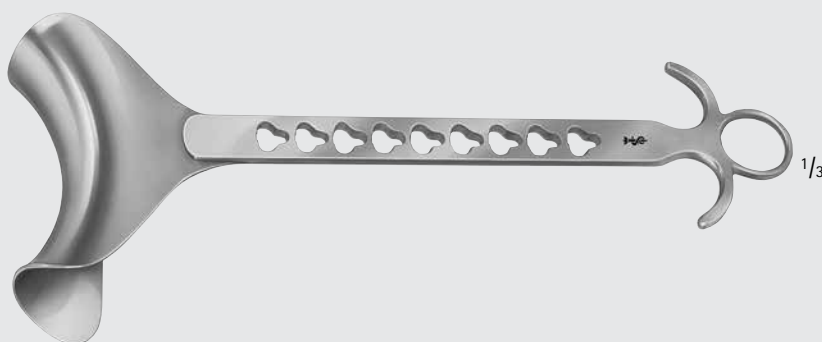

BT711R-BT715R



General Surgery  
Abdominal Retractors

Abdominal Retractor, Malleable, W/ Handle

Catalog Number	Blade Size (mm)	Blade Size (in.)	Length (in.)
BT773R	30	1 1/4	16 1/8
BT774R	40	1 1/2	16 1/8
BT775R	50	2	16 1/8
BT776R	60	2 1/2	16 1/8
BT777R	70	2 3/4	16 1/8

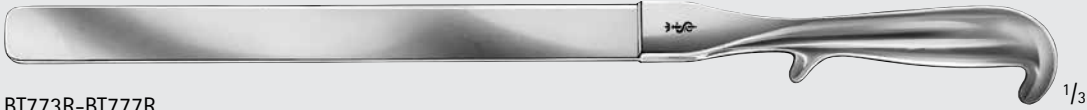

BT773R-BT777R <sup>1/3</sup>

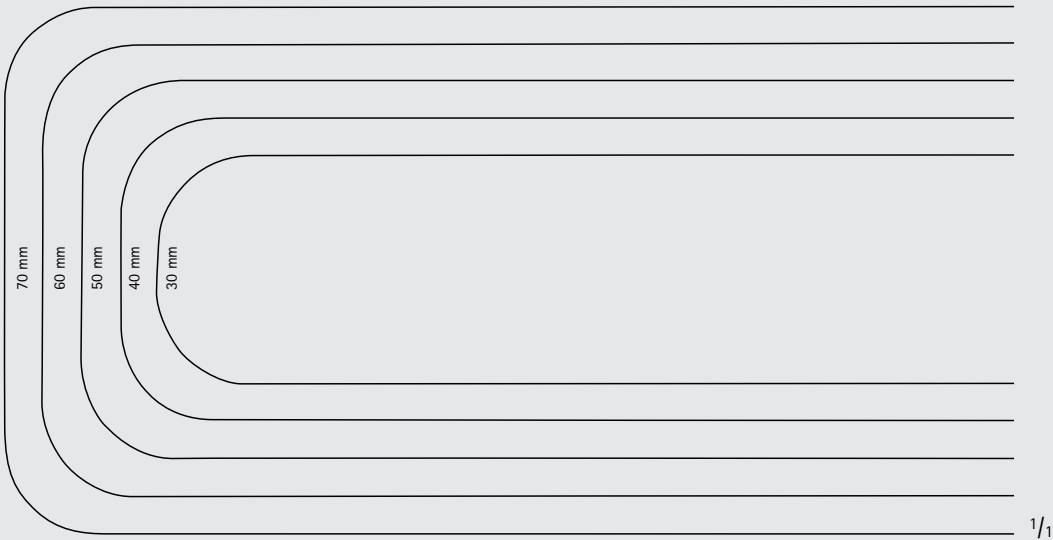

BT773R-BT777R <sup>1/1</sup>

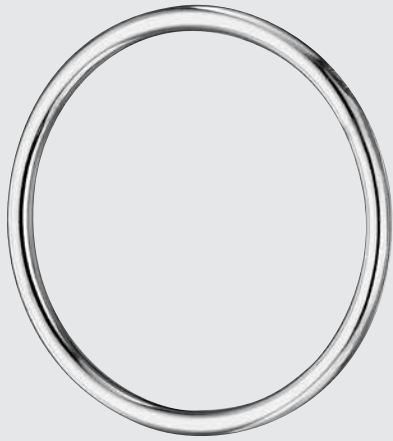

MB226, MG582R-MG586R

Laparotomy Ring

Catalog Number	Diameter (in.)
MG582R	1 1/2
MG585R	1 3/4
MB226	2
MG586R	3

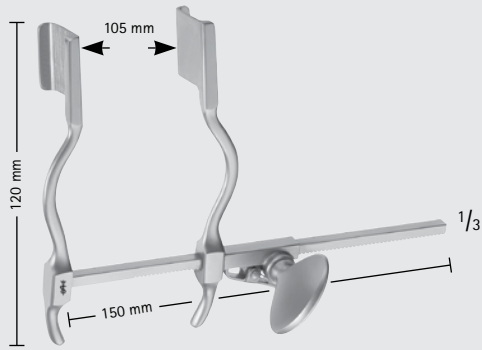

BV512R

HERTZLER Abdominal Retractor

Catalog Number	Blade Size (mm)
BV512R	20 x 25



INCHES

# General Surgery

## Abdominal Retractors

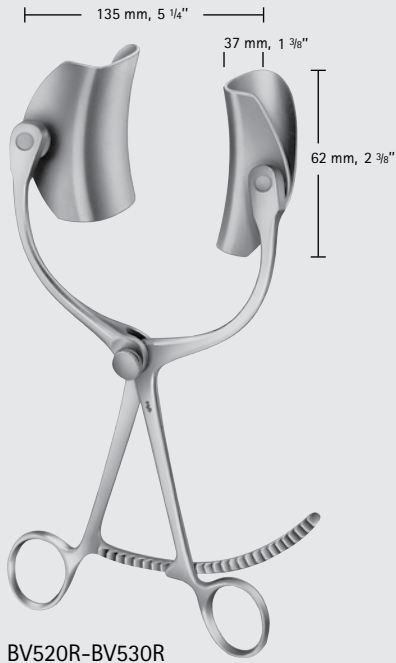

BV520R-BV530R



BV551R

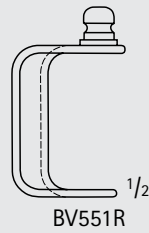

BV551R

### COLLIN Abdominal Retractor W/ Ball Snap Closure

Catalog Number	Description
BV530R	SET COMPLETE
BV520R	SPREADER ONLY
BV551R	LATERAL BLADES, Pair, 37 x 62 MM



BV399R

### Blade Ejector

Catalog Number	Description	Length (in.)
BV399R	FOR CHANGING BLADES WITH BALL SNAP CLOSURE	4 1/2

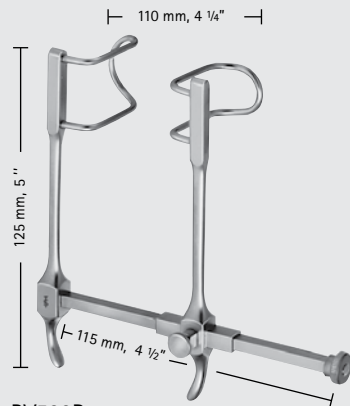

BV500R

GOSSET Abdominal Retractor, Small

Catalog Number	Blade Depth (mm)
BV500R	38

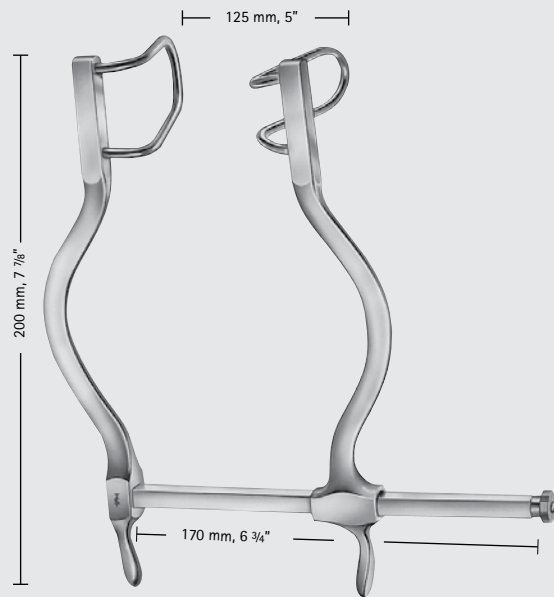

BV502R

GOSSET Abdominal Retractor, Medium

Catalog Number	Blade Depth (mm)
BV502R	55



# General Surgery

## Abdominal Retractors

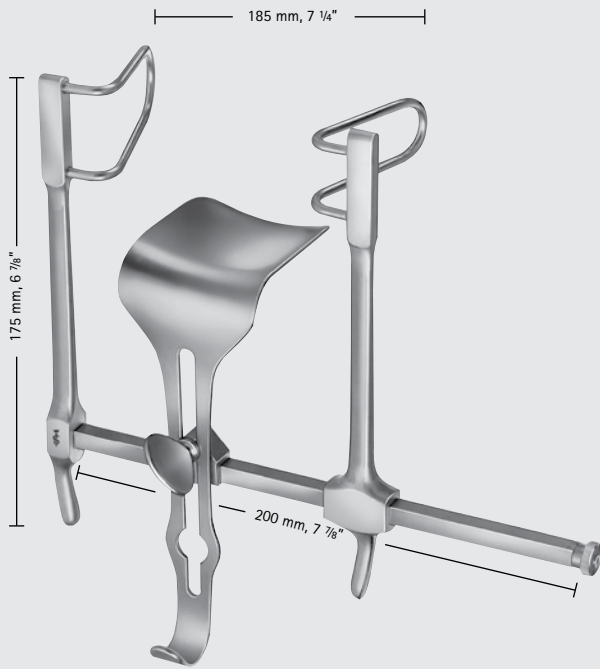

BV505R-BV506R

### GOSSET Abdominal Retractor, Large

Catalog Number	Description
BV505R	SET COMPLETE
BV506R	CENTER BLADE ONLY 59 x 57 MM

BV505R Includes:  
1 Center Blade BV506R

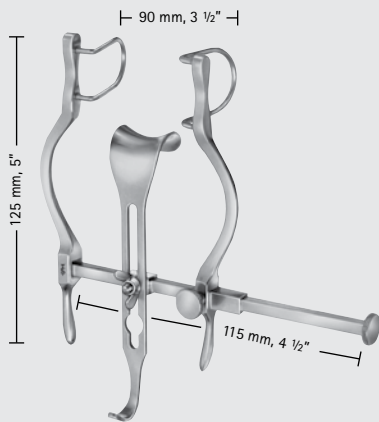

BV601R-BV602R

### BALFOUR Baby Abdominal Retractor

Catalog Number	Description
BV601R	SET COMPLETE
BV602R	CENTER BLADE ONLY, 21 x 24 MM

BV601R Includes:  
1 Center Blade BV602R

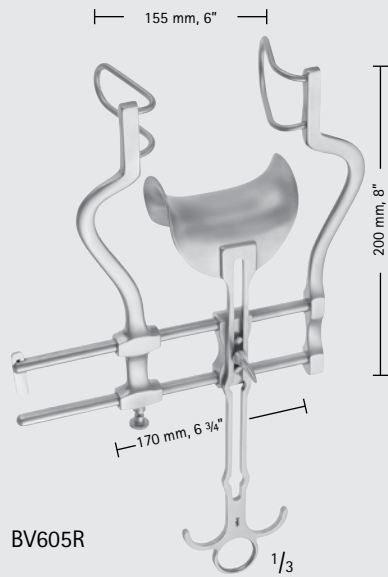

**BALFOUR Abdominal Retractor**

Catalog Number	Description	Lateral Blades Depth (mm)
BV605R	BALFOUR RETRACTOR, 200 x 155 MM	60
BV608R	BALFOUR RETRACTOR, 200 x 235 MM	60
BV610R	BALFOUR RETRACTOR, 200 x 265 MM	90
BV606R	CENTER BLADE, 47 x 80 MM	-
BV609R	CENTER BLADE, 62 x 76 MM	-
BV611R	CENTER BLADE, 80 x 80 MM	-

BV605R includes BV606R  
 BV608R includes BV609R  
 BV610R includes BV611R

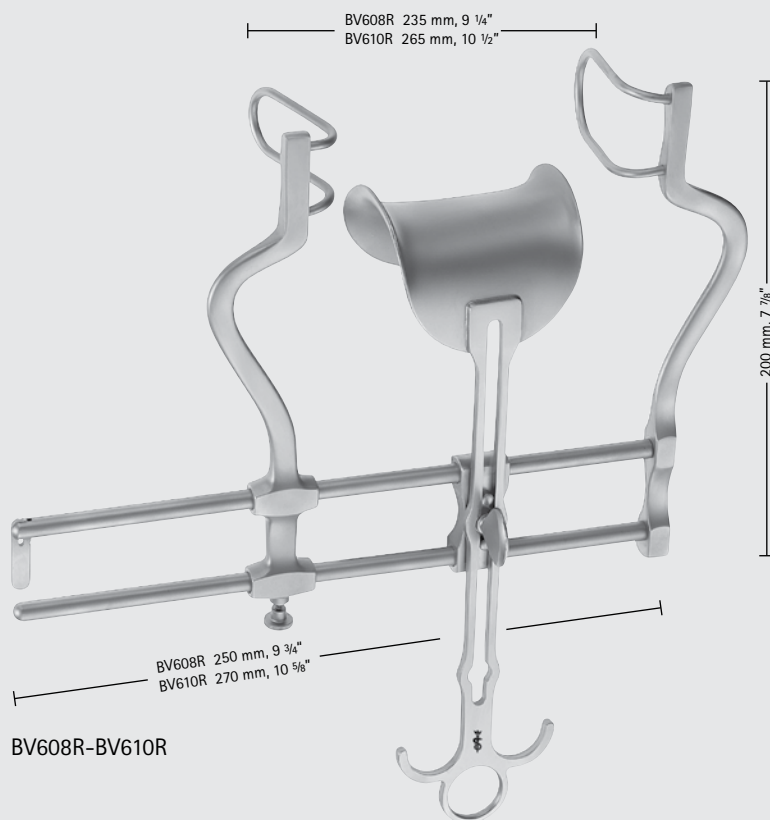

# General Surgery

## Abdominal Retractors

GENERAL SURGERY

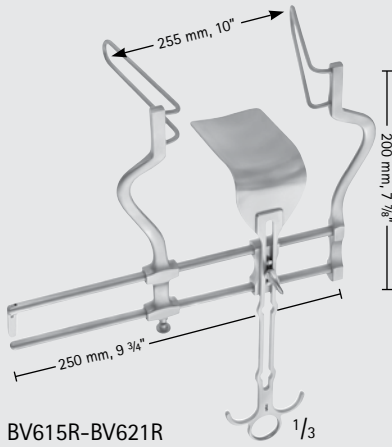
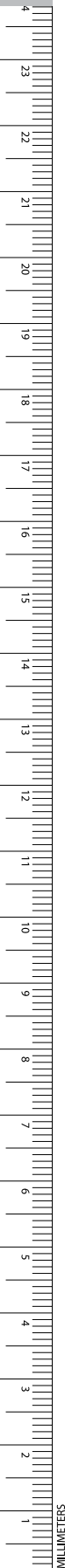

BV615R-BV621R

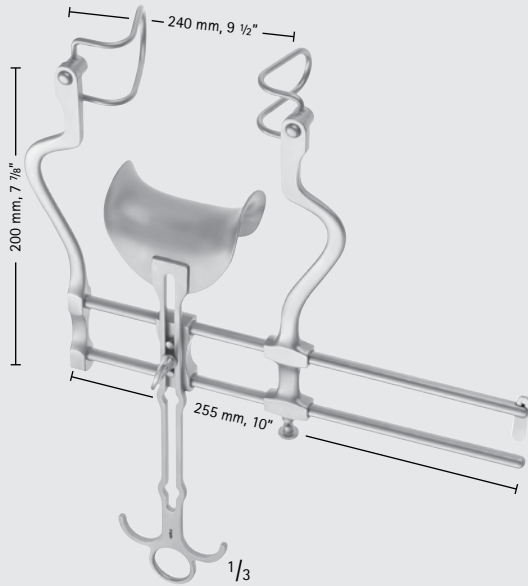

BV632R-BV638R

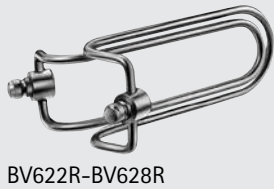

BV622R-BV628R

### BALFOUR Abdominal Retractor (continued)

Catalog Number	Description
BV615R	BALFOUR RETRACTOR, 200 x 255 MM COMPLETE W/ BV616R
BV632R	BALFOUR RETRACTOR, COMPLETE W/ BV606R, BV621R, BV622R
BV634R	BALFOUR RETRACTOR, COMPLETE W / BV609R, BV621R, BV624R
BV636R	BALFOUR RETRACTOR, COMPLETE W/ BV611R, BV621R, BV626R
BV638R	BALFOUR RETRACTOR, COMPLETE W/ BV611R, BV621R, BV628R
BV616R	CENTER BLADE, 107 x 59 MM
BV621R	SPREADER ONLY, 200 x 250 MM
BV622R	LATERAL BLADE, PAIR 50 MM
BV624R	LATERAL BLADE, PAIR 60 MM
BV626R	LATERAL BLADE, PAIR 75 MM
BV628R	LATERAL BLADE, PAIR 90 MM

**BALFOUR Side Blade Solid  
F/ Retractor MB221R, MB222R**

Catalog Number	Description
MB637R	PAIR, 2 1/2" (64 MM) DEEP
MB638R	PAIR, 3 1/2" (89 MM) DEEP
MB639R	PAIR, 4" (102 MM) DEEP



MB637R



MB638R



MB639R

**BALFOUR Side Blade Wire  
F/ Retractor MB221R, MB222R**

Catalog Number	Description
MB577R	PAIR, 2 1/2" (64 MM) DEEP
MB578R	PAIR, 3 1/2" (89 MM) DEEP
MB579R	PAIR, 4" (102 MM) DEEP



MB577R

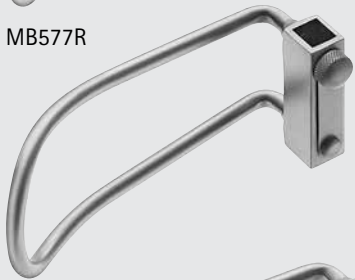

MB578R

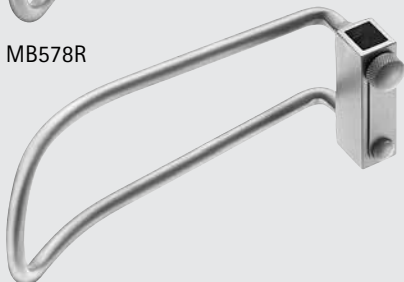

MB579R



General Surgery  
Abdominal Retractors

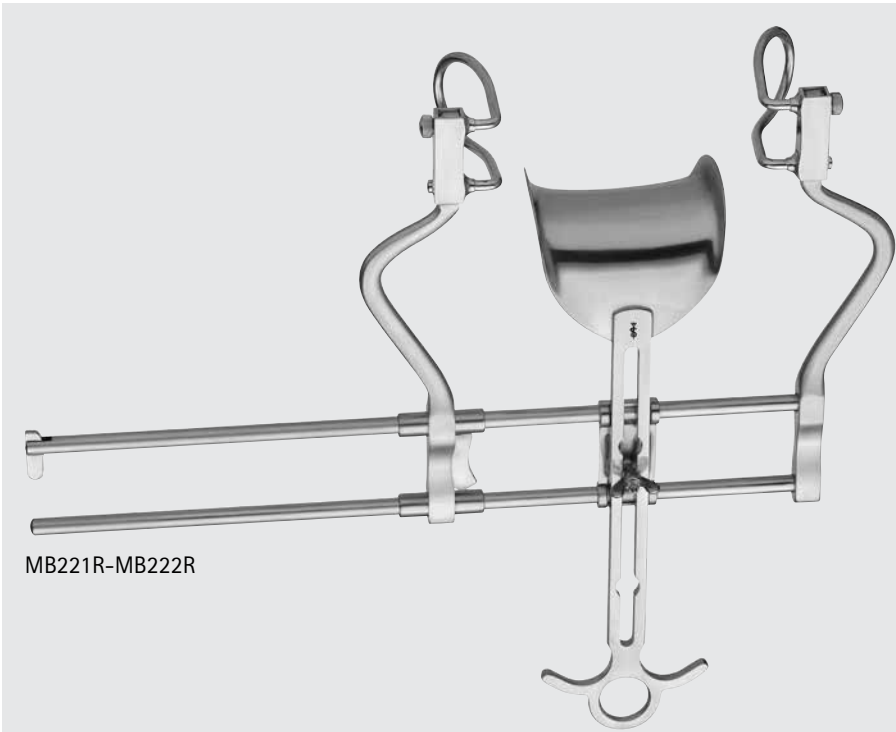

MB221R-MB222R

**BALFOUR Retractor W/ Exchangeable Lateral Blades**

Catalog Number	Total Width (in.)	Opening Width (in.)	Description
MB221R	16	10 1/2	2 PAIRS OF DETACHABLE BLADES 2 1/2" AND 3 1/2", 1 CENTER BLADE 2 3/4" x 3 1/4"
MB222R	16	8 1/2	2 PAIRS OF DETACHABLE BLADES 2 1/2" AND 3 1/2", 1 CENTER BLADE 2 1/2" x 2 1/2"



MB225

**BALFOUR Retractor**

Catalog Number	Total Width (in.)	Opening Width (in.)	Description
MB225	13	11	2 LATERAL BLADES 2" x 2" AND 1 1/4" x 2", 1 CENTER BLADE 3" x 10 1/2"

1/3



MB573R-MB574R

**DIXON Center Blade**

Catalog Number	Blade	Blade Size (mm)
MB573R	MALLEABLE	171 x 51
MB574R	MALLEABLE	267 x 57



BV617R

**BALFOUR Center Blade For All  
BALFOUR Retractors**

Catalog Number	Blade Size (mm)
BV617R	54 x 80

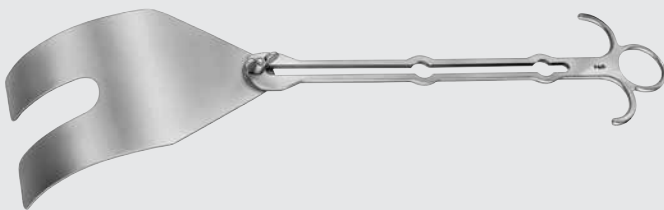

BV618R

**Center Blade F/ BV615R**

Catalog Number	Blade Size (mm)
BV618R	75 x 80



INCHES

General Surgery  
Abdominal Retractors

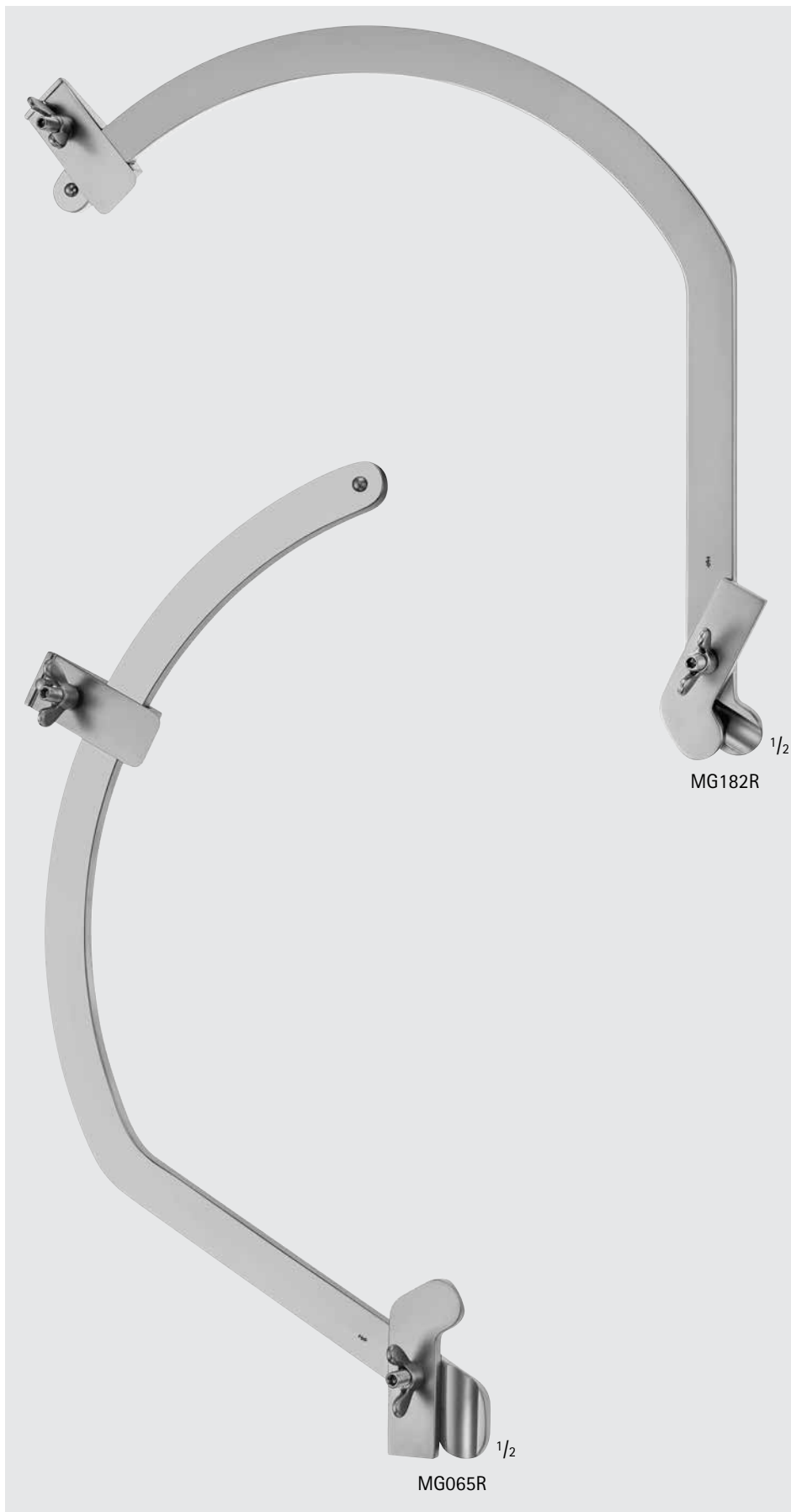

**BALFOUR Retractor Extension Arm**

Catalog Number	Description	Length (in.)
MG065R	ADULT ABDOMINAL, 4" BLADE F/ RIGHT ARM	9 1/2
MG182R	ADULT ABDOMINAL, 4" BLADE F/ LEFT ARM	9 1/2

MG182R

MG065R

# General Surgery

## Abdominal Retractors

### DENIS-BROWNE Abdominal Retractor

Catalog Number	Description
BV650R	COMPLETE SET
BV648R	2 BLADES ONLY, 40 x 30 MM
BV649R	2 BLADES ONLY, 40 x 40 MM
BV646R	BLADE ONLY, 20 x 30 MM

BV650R Includes:

1 Frame

2 Blades of each BV648R and BV649R

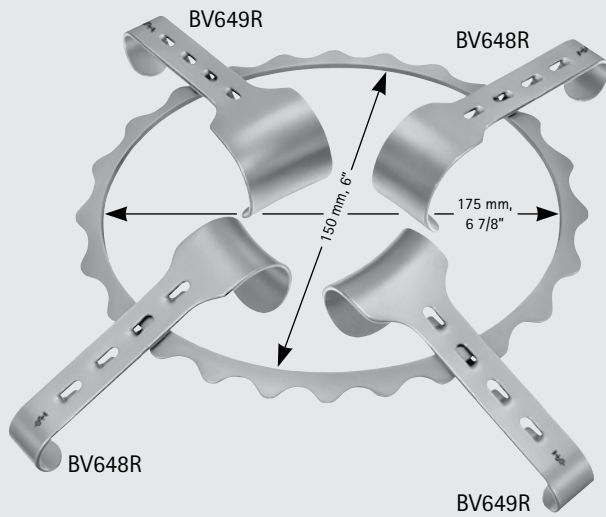

BV646R

General Surgery  
Abdominal Retractors



SEMM Abdominal Retractor

Catalog Number	Description	Blade Size (mm)		
BV654R	COMPLETE SET	-		
BV653R	FRAME	-		
BV655R	2 BLADES	46 x 64		
BV656R	BLADE	53 x 54		
BV657R	BLADE	82 x 97		
BV658R	BLADE <tr <td>BV659R</td> <td>BLADE</td> <td>107 x 36</td>	BV659R	BLADE	107 x 36

BV654R Includes:  
 1 Frame BV653R  
 1 Blade of each BV656R, BV657R,  
 BV658R and BV659R  
 2 Blades BV655R

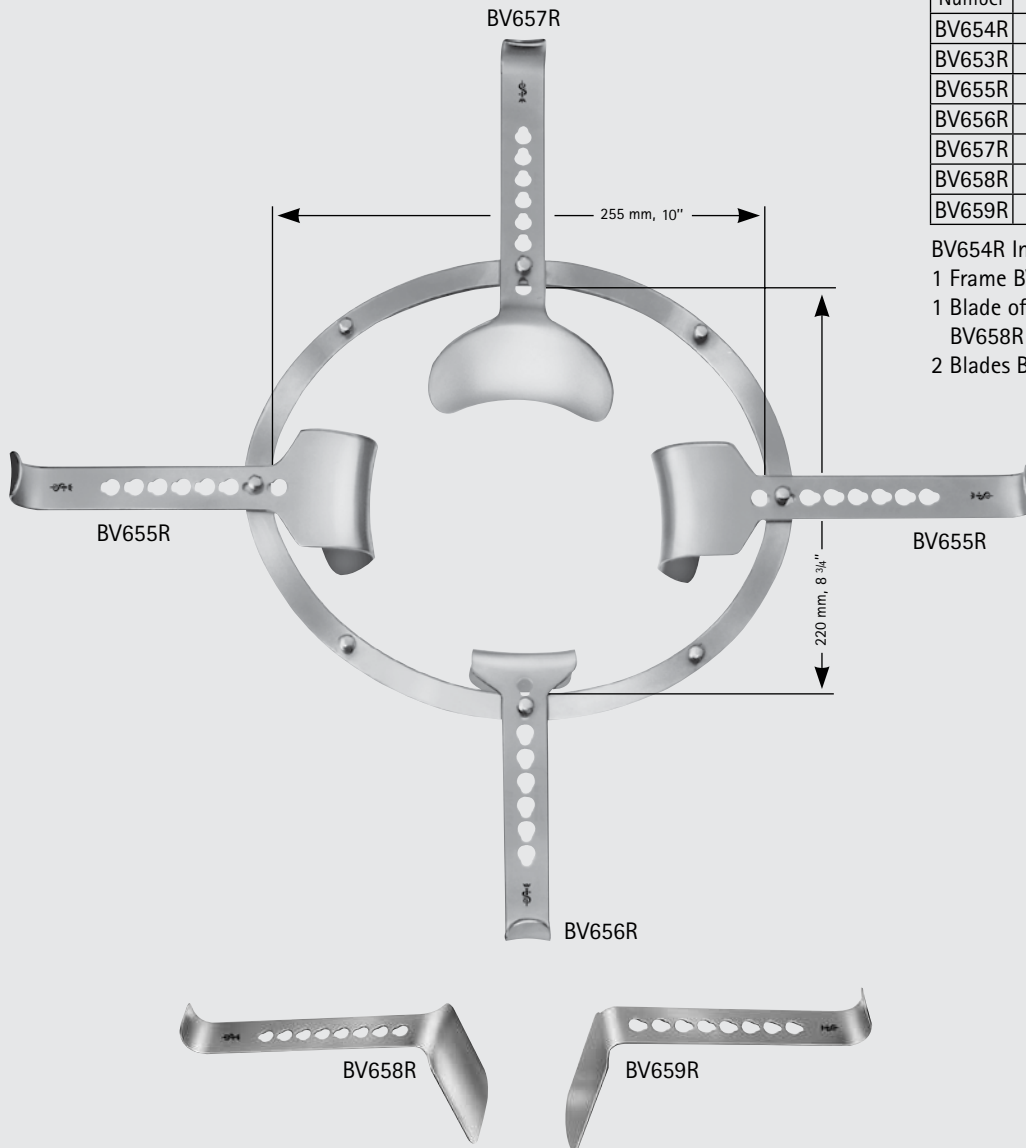

■ For more information about Universal Ring Retractor System see our brochure number DOC380.



MB499R

### Universal Ring Retractor System

Catalog Number	Description
MB499R	COMPLETE SET

#### Complete System Includes:

MB497	Segmented Medium Oval Ring
MB516	Medium Oval Ring
MB506	Standard Table Clamp 18"
MB488R	Horizontal Flex Bar w/ 360° Rotation 19 1/4"
MB487R	Horizontal Fixed Bar 15 1/2"
MB504	Post Clamp for 1" Bar
MB503	Non-Tilting Blade Clamp (2 each)
MB510	Tilting Blade Clamp (6 each)
MB524	KELLY Retractor Blade 2" x 3" (2 each)
MB525	KELLY Retractor Blade 2" x 4"
MB526	KELLY Retractor Blade 2" x 5"
MB527	KELLY Retractor Blade 2" x 6"
MB529	Malleable Retractor Blade 1 1/2" x 6"
MB530	Malleable Retractor Blade 2" x 6"
MB532	Malleable Retractor Blade 3" x 6"
MB534	BALFOUR Bladder Blade 3" x 2 1/2"
MB544	HARRINGTON Sweetheart Blade 2 1/2" x 5"
MB546	GELPI Point Retractor Blade



MB515-MB517

### Oval Ring

Catalog Number	Size	Width x Length (in.)
MB515	SMALL	8 1/2 x 12
MB516	MEDIUM	10 1/2 x 15
MB517	LARGE	12 1/2 x 18 1/2

# General Surgery

## Universal Ring Retractor System

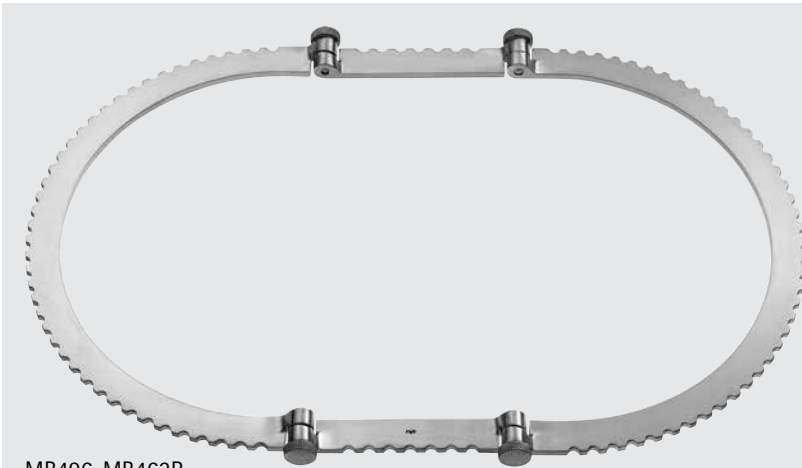

MB496-MB462R

### Segmented Oval Ring

Catalog Number	Size	Description	Width x Length (in.)
MB496	SMALL	INCLUDES REMOVABLE 4" SEGMENTS	8 1/2 x 14
MB497	MEDIUM	INCLUDES REMOVABLE 8" SEGMENTS	10 1/2 x 19 1/2
MB498	LARGE	INCLUDES REMOVABLE 6" SEGMENTS	12 1/2 x 19 1/2
MB462R	X-LARGE	INCLUDES REMOVABLE 6" SEGMENTS	16 x 22



MB471R-MB473R

### Segments for Segmented Oval Ring, Pair

Catalog Number	Length (in.)
MB471R	4
MB472R	6
MB473R	8



MB564

### URRS Segmented Ring Screw

Catalog Number
MB564



# General Surgery

## Universal Ring Retractor System

### Round Ring

Catalog Number	Size	Diameter (in.)
MB519	SET	-
MB520	SMALL	8 1/2
MB521	MEDIUM	10 1/2
MB522	LARGE	12 1/2

MB519 Includes:  
1 Ring of each MB520-MB522

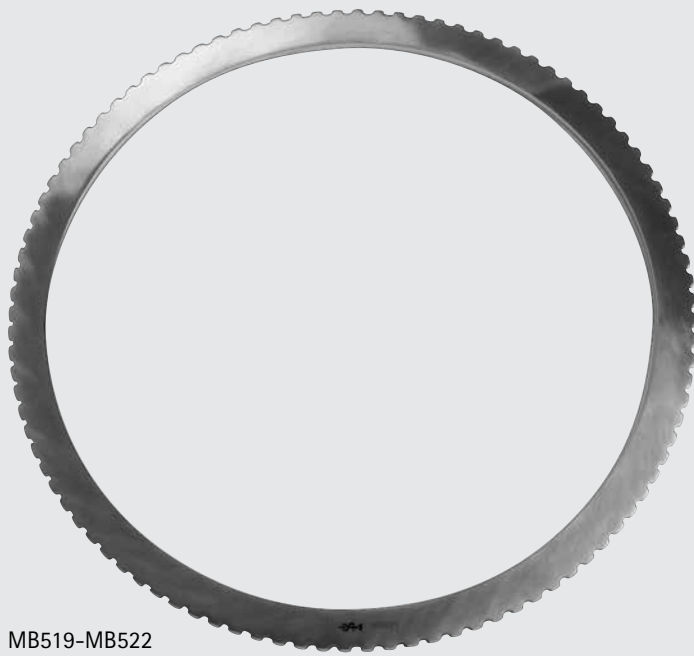

MB519-MB522

### Segmented Round Ring

Catalog Number	Size	Diameter (in.)
MB825R	SMALL	8 1/2
MB826R	MEDIUM	10 1/2
MB827R	LARGE	12 1/2
MB828R	X-LARGE	16

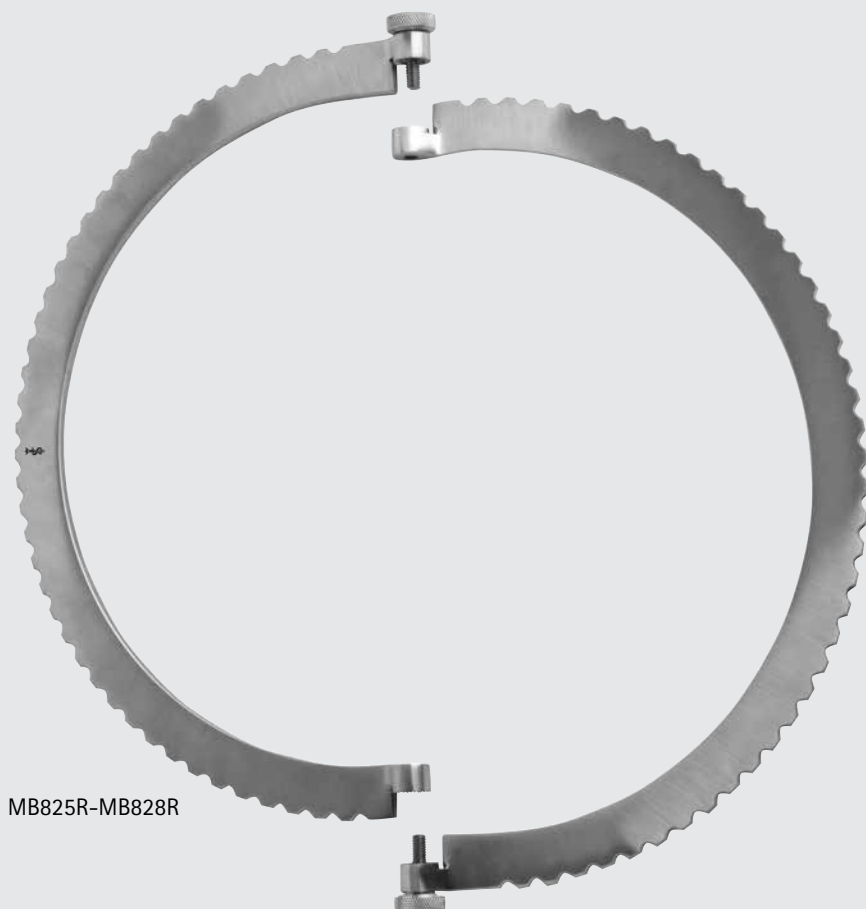

MB825R-MB828R



INCHES

# General Surgery

## Universal Ring Retractor System

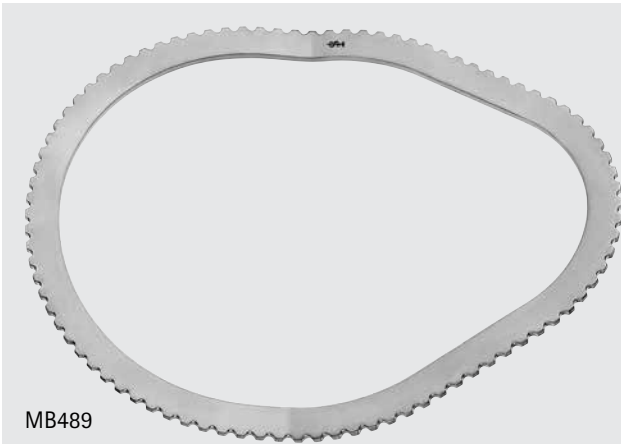

MB489

### Vaginal Ring

Catalog Number	Description	Width x Length (in.)
MB489	20° ANGLE	8 x 10 1/2



MG511R

1/2

### Tilt and Swivel Clamp

Catalog Number
MG511R

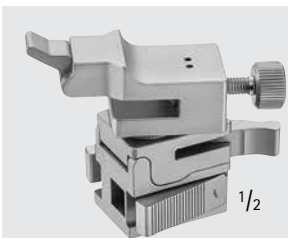

MB973R

1/2

### Multi Directional Blade Clamp

Catalog Number
MB973R



MB503

Non-Tilting Blade Clamp

Catalog Number
MB503

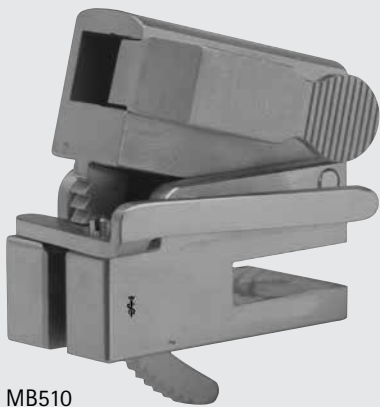

MB510

Tilting Blade Clamp

Catalog Number
MB510

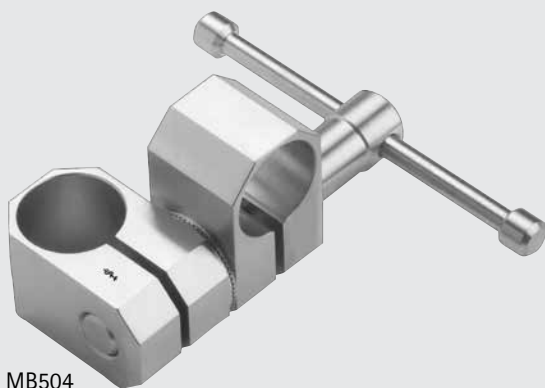

MB504

Post Clamp

Catalog Number
MB504



INCHES

# General Surgery

## Universal Ring Retractor System

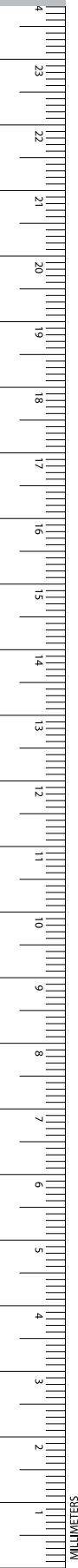

MB460R-MB506

### Table Clamp

Catalog Number	Working Length (in.)	Length (in.)
MB506	15	18
MB460R	21	24



MB670R-MB821R

### Flat Table Clamp

Catalog Number	Working Length (in.)	Total Length (in.)
MB670R	11 1/2	18
MB821R	17	24



MB487R-MB823R

### Horizontal Fixed Bar

Catalog Number	Length (in.)
MB487R	15 1/2
MB823R	22

Horizontal Flex Bar W/ 360° Rotation

Catalog Number	Length (in.)
MB488R	19
MB824R	22 1/2



MB488R-MB824R

Vertical Extension Bar

Catalog Number	Length (in.)
MB508	12
MB822R	14



MB508-MB822R

Adapter For Attaching Handheld Retractors

Catalog Number
MB509



MB509



INCHES

# General Surgery

## Universal Ring Retractor System

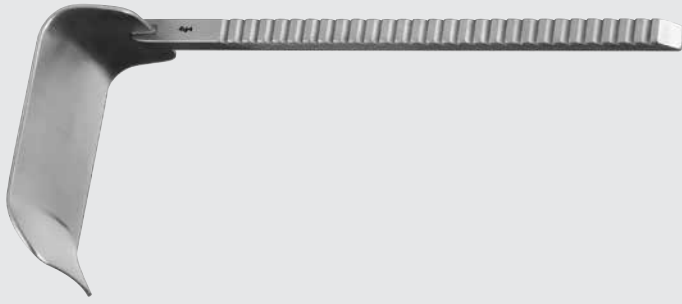

MB469R-MB555

### KELLY Retractor Blade

Catalog Number	Description	Width x Depth (in.)
MB555	-	1 x 1 1/2
MB556	-	1 x 2 1/2
MB936R	-	2 x 1 1/2
MB937R	-	2 x 2 1/2
MB524	-	2 x 3
MB525	-	2 x 4
MB526	-	2 x 5
MB527	-	2 x 6
MB469R	BARIATRIC	2 x 8



MB938A-MB943A

### Aluminum KELLY Retractor Blade

Catalog Number	Description	Width x Depth (in.)
MB938A	-	2 x 2 1/2
MB939A	-	2 x 3
MB940A	-	2 x 4
MB941A	-	2 x 5
MB942A	-	2 x 6
MB943A	BARIATRIC	2 x 8



MB467R-MB860R

Malleable Retractor Blade

Catalog Number	Description	Width x Depth (in.)
MB860R	-	3/4 x 2
MB861R	-	3/4 x 3
MB862R	-	1 x 1
MB863R	-	1 x 4
MB864R	-	1 x 5
MB865R	-	1 1/2 x 3
MB866R	-	1 1/2 x 4
MB529	-	1 1/2 x 6
MB867R	-	1 1/2 x 8
MB530	-	2 x 6 1/2
MB531	-	2 x 8
MB463R	BARIATRIC	2 x 10
MB532	-	3 x 6
MB464R	BARIATRIC	3 x 10
MB466R	BARIATRIC	3 x 12
MB869R	BARIATRIC	4 x 8
MB465R	BARIATRIC	4 x 10
MB467R	BARIATRIC	4 x 12

Aluminum Malleable Retractor Blade,  
Flat

Catalog Number	Description	Width x Depth (in.)
MB954A	-	1 1/2 x 6
MB955A	-	2 x 6
MB956A	-	2 x 8
MB957A	-	3 x 6
MB958A	BARIATRIC	2 x 10
MB959A	BARIATRIC	3 x 10



MB954A-MB959A

# General Surgery

## Universal Ring Retractor System



MB557-MB559

### RICHARDSON Retractor

Catalog Number	Width x Depth (in.)
MB557	3/4 x 1
MB558	3/4 x 2
MB559	1 x 1 1/4



MB470R-MB534

### BALFOUR Bladder Blade

Catalog Number	Description	Width x Depth (in.)
MB534	-	3 x 2 1/2
MB535	-	3 x 3 1/4
MB470R	BARIATRIC	3 x 3 1/2

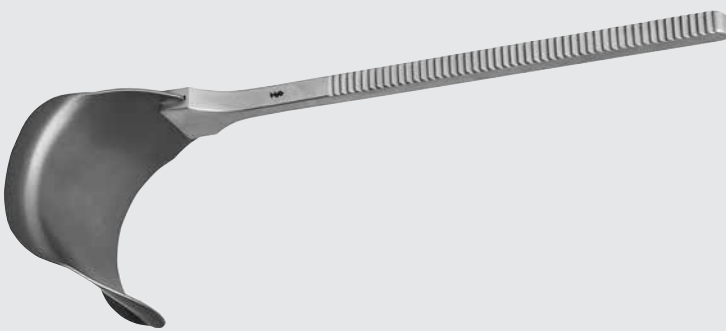

MB829A-MB830A

### Aluminum BALFOUR Bladder Blade

Catalog Number	Width x Depth (in.)
MB829A	2 x 2 3/8
MB830A	3 x 2 1/2



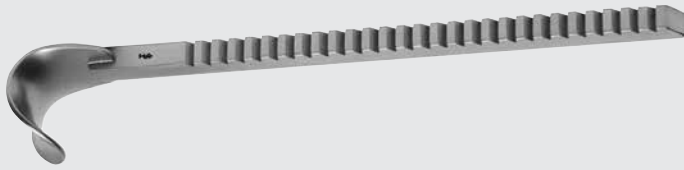

MB968R-MB969R

**MAYO Retractor Blade**

Catalog Number	Width x Depth (in.)
MB968R	1 1/4 x 1 1/4
MB969R	2 x 2

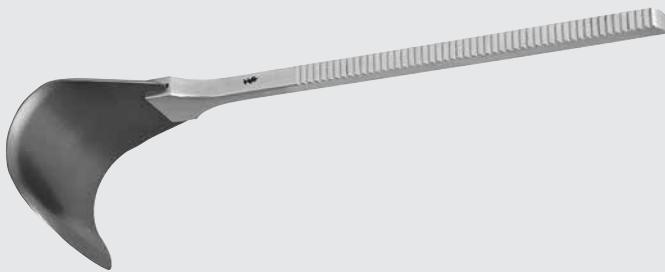

MB970A

**Aluminum MAYO Retractor Blade**

Catalog Number	Width x Depth (in.)
MB970A	2 3/4 x 2



MB537-MB539

**DEEVER Retractor Blade**

Catalog Number	Width x Depth (in.)
MB537	1 x 4 1/2
MB538	1 1/2 x 4 1/2
MB539	2 x 4 1/2



MB492-MB493

**DEEVER Vaginal Retractor Blade**

Catalog Number	Description	Width x Depth (in.)
MB492	SMALL	1 x 3 1/2
MB493	LARGE	1 x 5



INCHES

# General Surgery

## Universal Ring Retractor System



MB490

Vaginal Retractor Posterior Blade

Catalog Number	Width x Depth (in.)
MB490	1 x 4 1/2



MB491

Vaginal Retractor Lateral Blade

Catalog Number	Width x Depth (in.)
MB491	1 x 3



MB871R

ST. MARK'S Deep Pelvic Retractor Blade

Catalog Number	Width x Depth (in.)
MB871R	2 3/8 x 7 1/2



**Rectal Blade**

Catalog Number	Description	Width x Depth (in.)
MB494	SMALL	7/8 x 2 7/8
MB495	LARGE	7/8 x 3 7/8

MB494-MB495

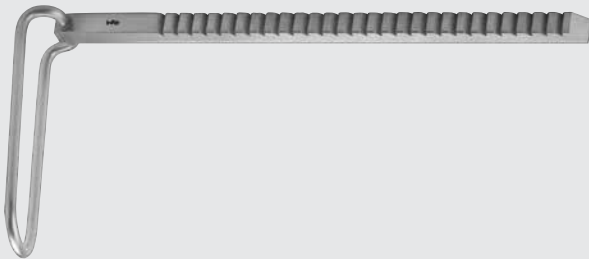

**Skin Incision Blade**

Catalog Number	Width x Depth (in.)
MB541	1 1/8 x 3 1/4

MB541



# General Surgery

## Universal Ring Retractor System



MB543-MB832R

### HARRINGTON Sweetheart Blade

Catalog Number	Description	Width x Depth (in.)
MB543	-	1 1/2 x 5
MB544	-	2 1/2 x 5 5/8
MB468R	BARIATRIC	3 1/2 x 10
MB832R	BARIATRIC	4 1/2 x 10



MB833A-MB835A

### Aluminum HARRINGTON Sweetheart Blade

Catalog Number	Description	Width x Depth (in.)
MB833A	-	2 1/2 x 4
MB834A	-	3 1/2 x 8
MB835A	BARIATRIC	3 1/2 x 10



MB546

### GELPI Point Retractor Blade

Catalog Number
MB546



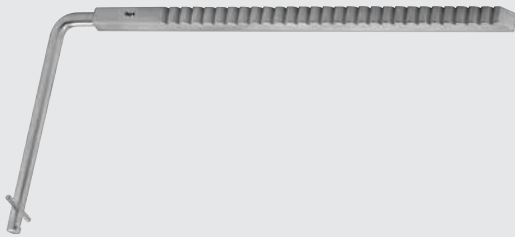

MB548-MB549

**SCOVILLE Hook Retractor Blade**

Catalog Number	Description	Depth (in.)
MB549	SMALL	2
MB548	LARGE	3 1/4



MB566-MB568

**Rake Retractor**

Catalog Number	Description	Width x Depth (in.)
MB566	3 PRONGS	2/3 x 3/4
MB567	4 PRONGS	3/4 x 1/3
MB568	6 PRONGS	1 x 1/3



MB551-MB553

**MEYERDING Retractor Blade**

Catalog Number	Width x Depth (in.)
MB551	1 x 3 1/3
MB552	2 x 3 3/4
MB553	2/3 x 2 1/3



# General Surgery

## Universal Ring Retractor System

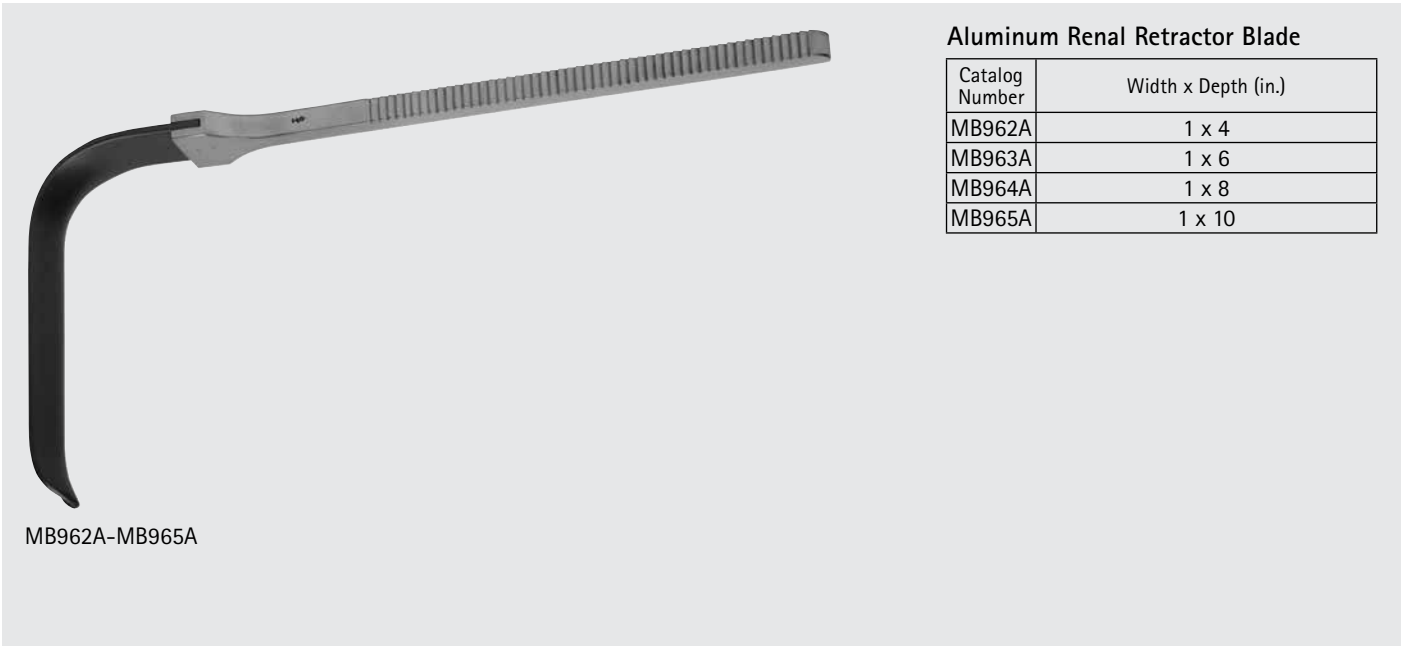
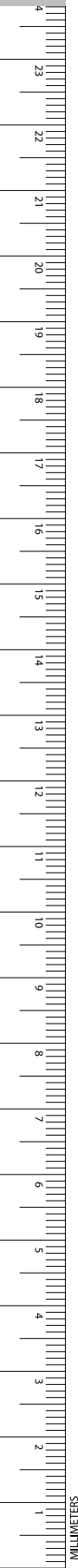

**Aluminum Renal Retractor Blade**

Catalog Number	Width x Depth (in.)
MB962A	1 x 4
MB963A	1 x 6
MB964A	1 x 8
MB965A	1 x 10

MB962A-MB965A

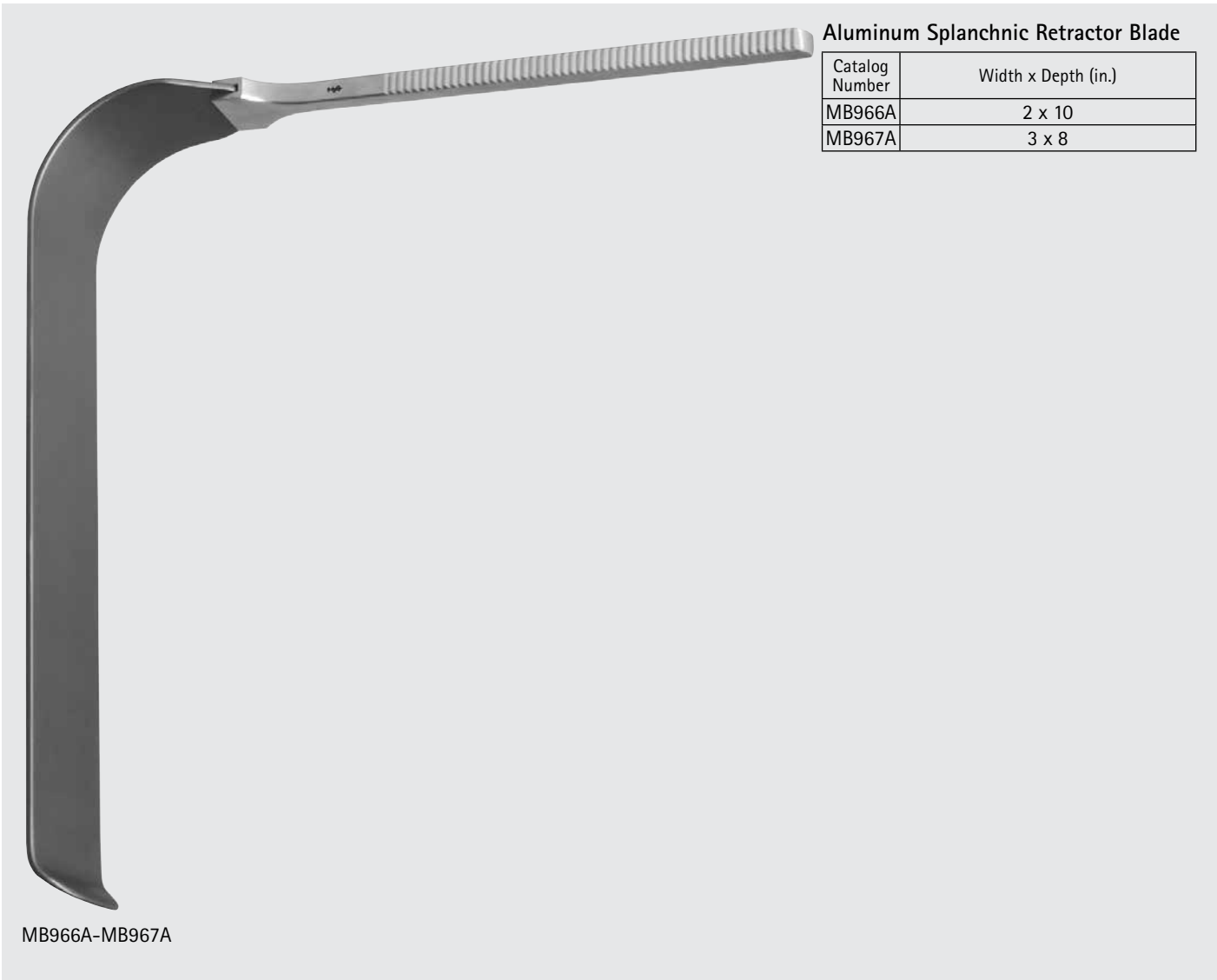

**Aluminum Splanchnic Retractor Blade**

Catalog Number	Width x Depth (in.)
MB966A	2 x 10
MB967A	3 x 8

MB966A-MB967A

Perforated Super Malleable Retractor  
 Blade

Catalog Number	Width x Depth (in.)
MB960R	2 x 9
MB961R	3 x 9

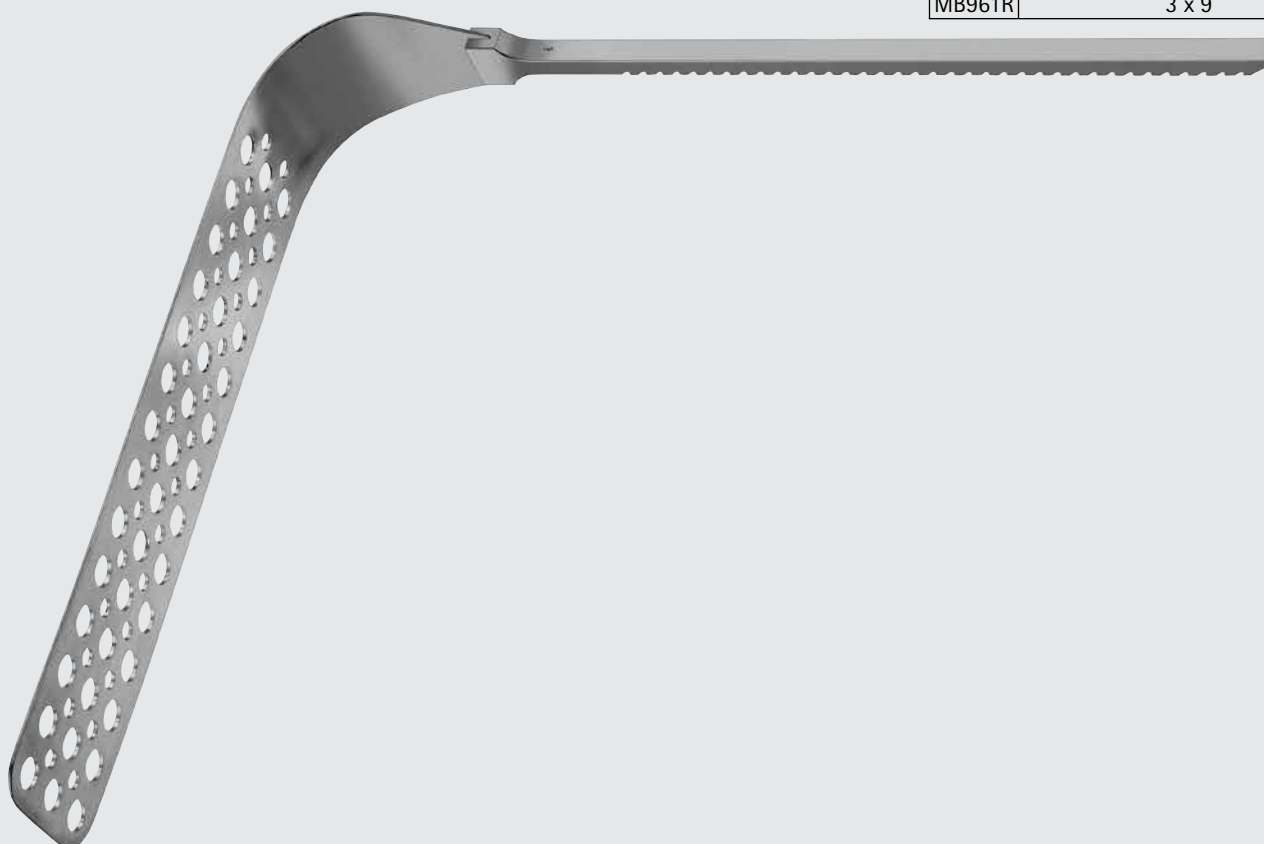

MB960R-MB961R

YU-HOLTGREWE Malleable Retractor  
 Blade

Catalog Number	Width x Depth (in.)
MB870R	2 1/2 x 6

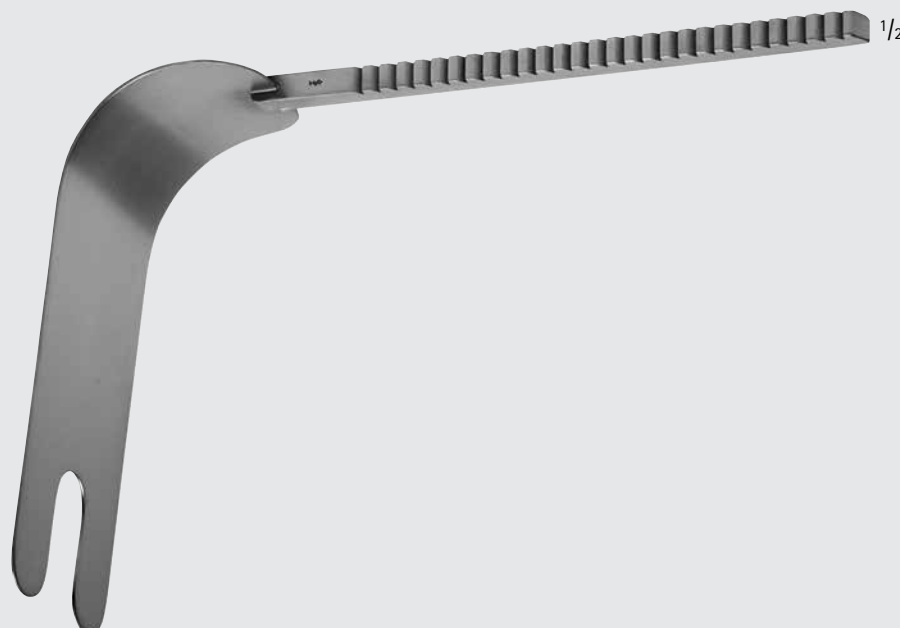

MB870R

# General Surgery

## Self Retaining Retractors



BV001R



BV001R

### FINSEN Retractor

Catalog Number	Tip	Blade End	Length (in.)
BV001R	SHARP	2 x 3 PRONGS	2



BV002R

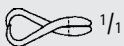

BV002R

### FINSEN Retractor

Catalog Number	Tip	Blade End	Length (in.)
BV002R	SHARP	3 x 4 PRONGS	2 3/4



BV003R

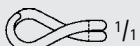

BV003R

### FINSEN Modified Retractor

Catalog Number	Tip	Blade End	Length (in.)
BV003R	BLUNT	2 x 3 PRONGS	3



BV005R



BV005R

### FINSEN Retractor

Catalog Number	Tip	Blade End	Length (in.)
BV005R	SHARP	3 x 4 PRONGS	2 3/4



BV014R

### PARSONNET Epicardial Retractor

Catalog Number	Tip	Blade End	Length (in.)
BV014R	SHARP	3 x 3 PRONGS	2

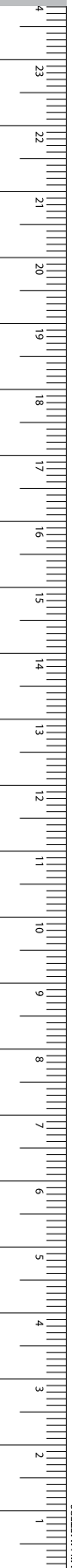



BV006R-BV007R



BV006R

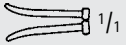

BV007R

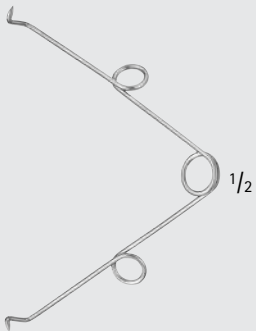

MD471

Spring Wire Retractor

Catalog Number	Tip	Prongs	Length (in.)
BV006R	BLUNT	3 x 3	1 3/4
BV007R	BLUNT	3 x 3	2 1/4
MD471	SHARP	1 x 1	3

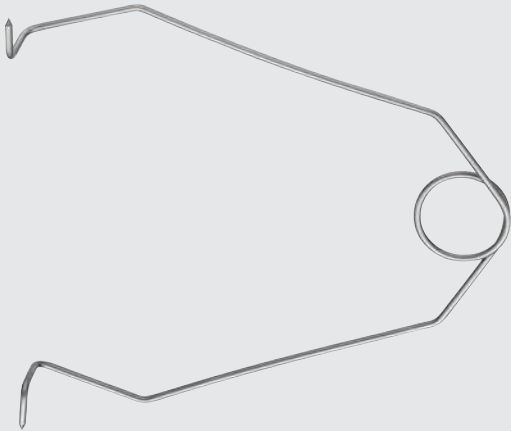

MB196R-MB777R

Spring Wire Retractor

Catalog Number	Size	Length (in.)
MB777R	SMALL	5
MB778R	MEDIUM	5 1/8
MB196R	LARGE	9



INCHES

# General Surgery

## Self Retaining Retractors



BV010R-BV011R



BV010R



BV011R

### ALM Retractor

Catalog Number	Tip	Blade End	Length (in.)
BV010R	SHARP	4 x 4 PRONGS	2 3/4
BV011R	SHARP	4 x 4 PRONGS	4



BV008R-BV015R



BV008R



BV015R

### HEISS Self-Retaining Retractor

Catalog Number	Tip	Blade End	Length (in.)
BV015R	SHARP	4 x 4 PRONGS	4
BV008R	BLUNT	4 x 4 PRONGS	4



WEITLANER Retractor

Catalog Number	Tip	Blade End	Length (in.)
BV073R	BLUNT	2 x 3 PRONGS	4 1/4
MA438R	BLUNT	3 x 3 PRONGS	4 1/4
BV074R	BLUNT	3 x 4 PRONGS	5 1/8
BV075R	BLUNT	3 x 4 PRONGS	6 1/2
BV104R	BLUNT/ DEEP	3 x 4 PRONGS	5 1/8

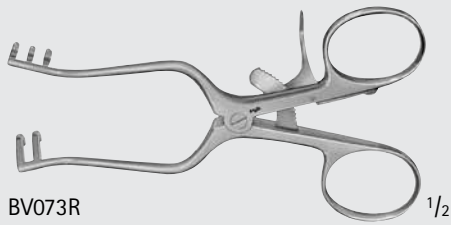

BV073R 1/2

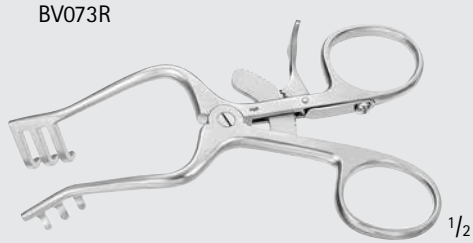

MA438R 1/2

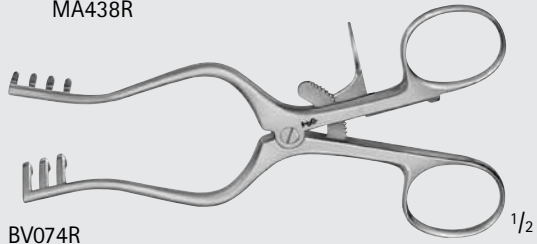

BV074R 1/2

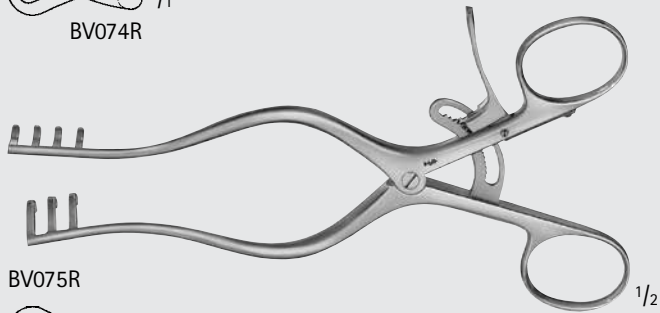
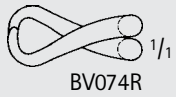

BV075R 1/2

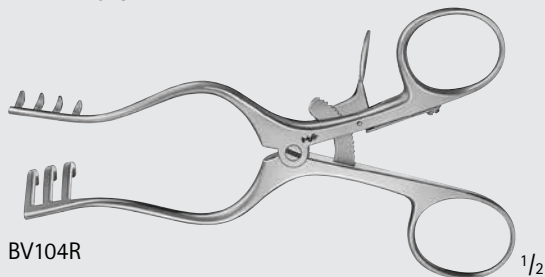
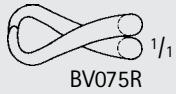

BV104R 1/2

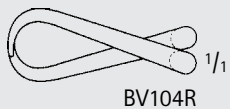

BV104R



INCHES

# General Surgery

## Self Retaining Retractors

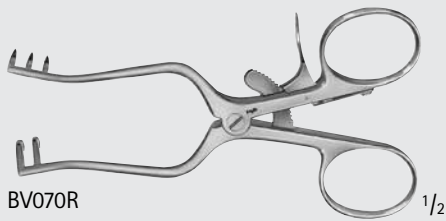

BV070R

1/2



BV070R

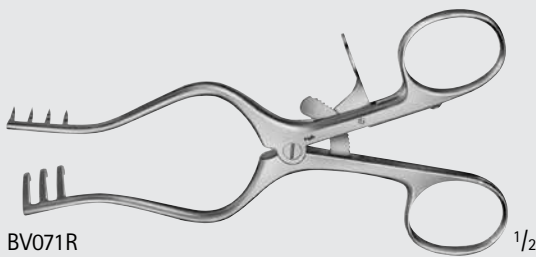

BV071R

1/2

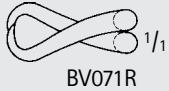

BV071R

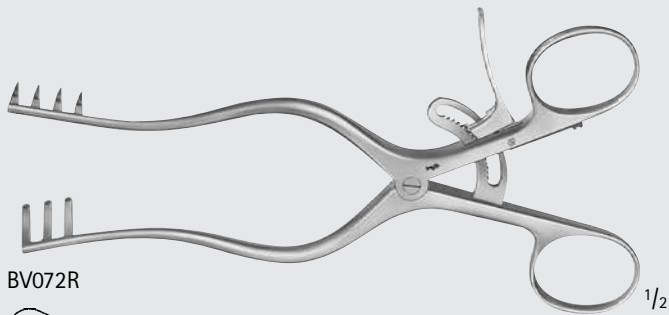

BV072R

1/2



BV072R

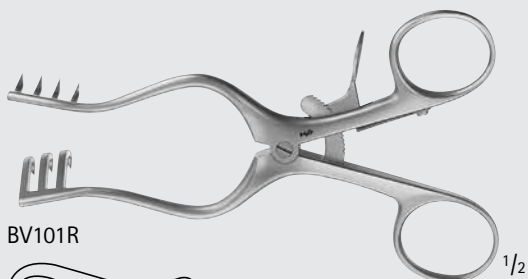

BV101R

1/2



BV101R

### WEITLANER Retractor

Catalog Number	Tip	Blade End	Length (in.)
BV070R	SHARP	2 x 3 PRONGS	4 1/4
BV071R	SHARP	3 x 4 PRONGS	5 1/8
BV072R	SHARP	3 x 4 PRONGS	6 1/2
BV101R	SHARP/DEEP	3 x 4 PRONGS	5 1/8
BV066R	SEMI-S	2 x 3 PRONGS	4 1/4
BV067R	SEMI-S	3 x 4 PRONGS	5 1/8
BV068R	SEMI-S	3 x 4 PRONGS	6 1/2



BV066R

1/2



BV066R

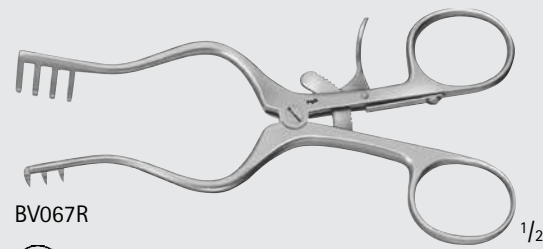

BV067R

1/2



BV067R

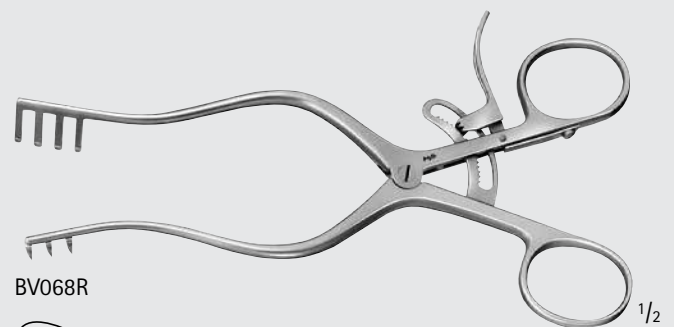

BV068R

1/2

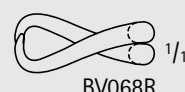

BV068R

# General Surgery

## Self Retaining Retractors

### WULLSTEIN Retractor

Catalog Number	Tip	Blade End	Length (in.)
BV076R	SHARP	3 x 3 PRONGS	5
BV077R	BLUNT	3 x 3 PRONGS	5

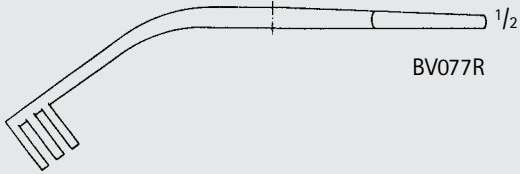
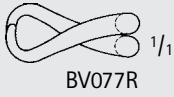
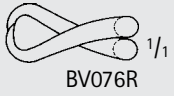

### Baby ADSON Retractor, Hinged

Catalog Number	Tip	Blade End	Length (in.)
BV085R	SEMI-S	3 x 4 PRONGS	5 1/2
BV094R	SEMI-S	3 x 4 PRONGS	6 1/2

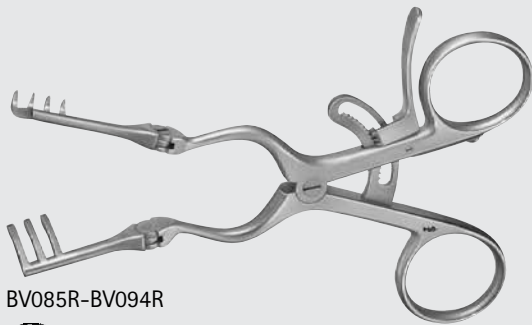

BV085R-BV094R



BV085R-BV094R

### Baby ADSON Retractor, Angled

Catalog Number	Tip	Blade End	Length (in.)
MG007R	BLUNT	4 x 4 PRONGS	7 1/2

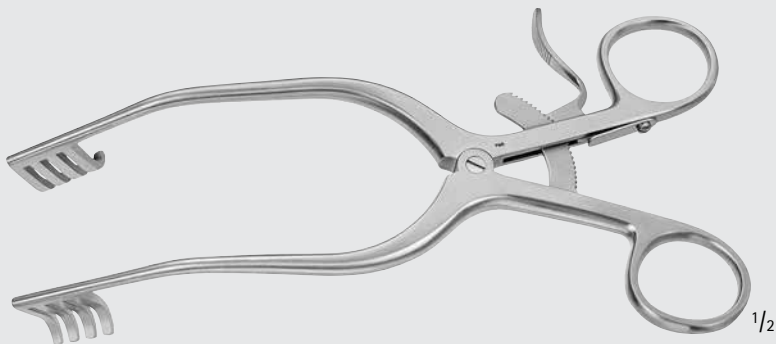

MG007R



# General Surgery

## Self Retaining Retractors



BV200R-BV209R

### WEITLANER Retractor

Catalog Number	Tip	Blade End	Length (in.)
BV200R	SHARP	3 x 4 PRONGS	7 7/8
BV206R	SHARP	3 x 4 PRONGS	9 1/2
BV208R	SHARP	5 x 6 PRONGS	10
BV201R	BLUNT	3 x 4 PRONGS	7 7/8
BV207R	BLUNT	3 x 4 PRONGS	9 1/2
BV209R	BLUNT	5 x 6 PRONGS	10

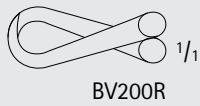

BV200R

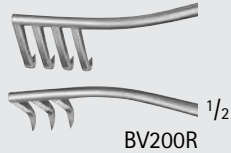

BV200R

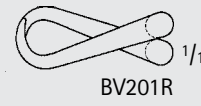

BV201R

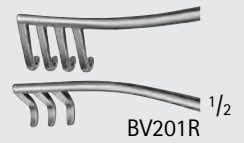

BV201R

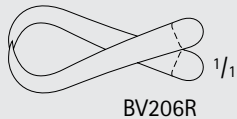

BV206R

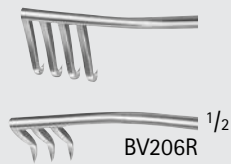

BV206R

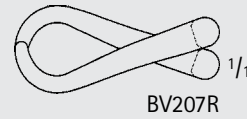

BV207R

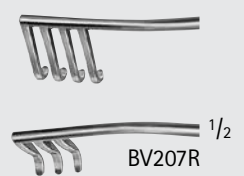

BV207R

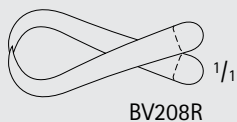

BV208R

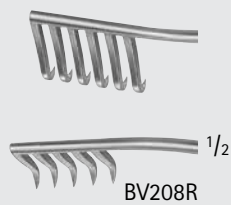

BV208R

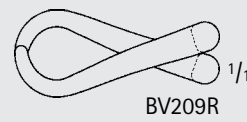

BV209R

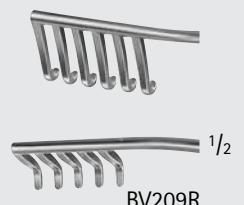

BV209R

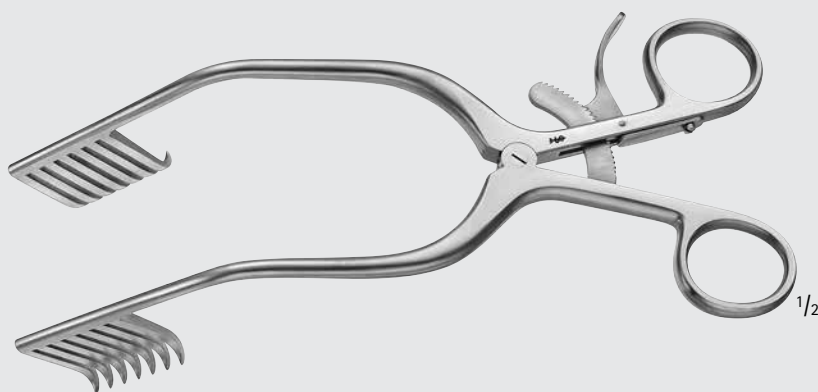

MB476R

### MISKIMON Cerebellar Retractor

Catalog Number	Tip	Blade End	Length (in.)
MB476R	SHARP	7 x 7 PRONGS	7 7/8



MB476R

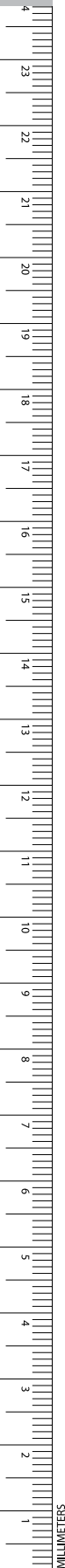



Thyroid Retractor

Catalog Number
BV086R

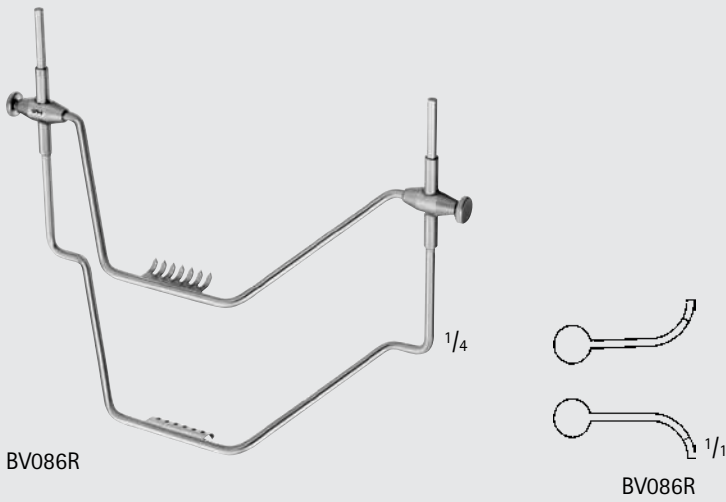

BV086R

BV086R

JOLL (FRIEDMANN) Thyroid/Vaginal Retractor

Catalog Number	Length (in.)
BV087R	6 1/8

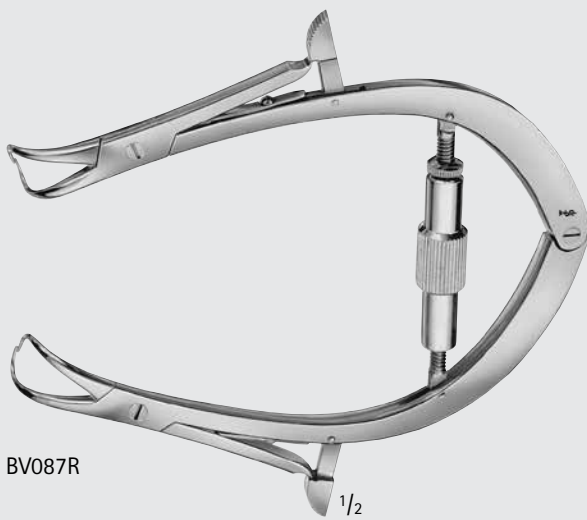

BV087R

1/2

MOLLISON Retractor

Catalog Number	Tip	Blade End	Length (in.)
BV088R	SHARP	4 x 4 PRONGS	6 1/8

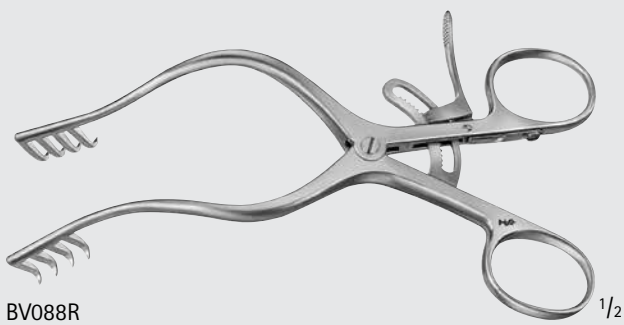

BV088R

1/2

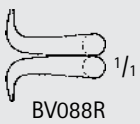

BV088R

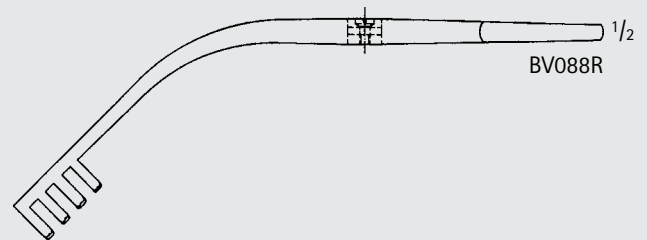

BV088R

# General Surgery

## Self Retaining Retractors

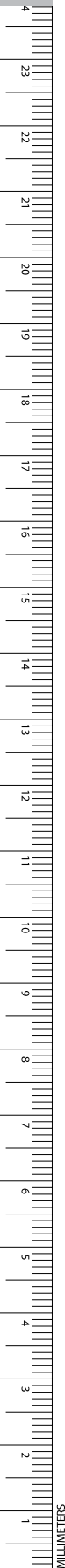

**MAYO-ADAMS Retractor**

Catalog Number	Length (in.)
BV112R	6 1/2

BV112R <sup>1/2</sup>

BV112R <sup>1/1</sup>

**WILSTE-GELPI Retractor**

Catalog Number	Tip	Tip Size (mm)	Length (in.)
MB929R	SHARP	70	11

MB929R <sup>1/2</sup>

MB929R <sup>1/1</sup>

**GELPI Perineal Retractor**

Catalog Number	Tip	Length (in.)
MB199R	SHARP WITH BALL STOPS	7

MB199R <sup>1/2</sup>

MB199R <sup>1/1</sup>

# General Surgery

## Self Retaining Retractors

GENERAL SURGERY

### GELPI Vaginal Retractor

Catalog Number	Tip	Length (in.)
MG176R	SHARP	3 1/2
BV996R	SHARP	5 1/4
BV997R	SHARP	6 7/8
MD651	SHARP	7 1/4
MG177R	BLUNT	4 1/2

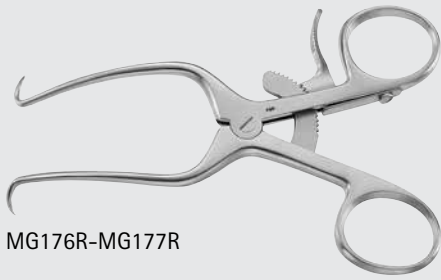

MG176R-MG177R



MG176R



MG177R



BV996R

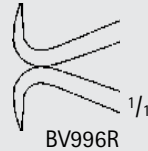

BV996R

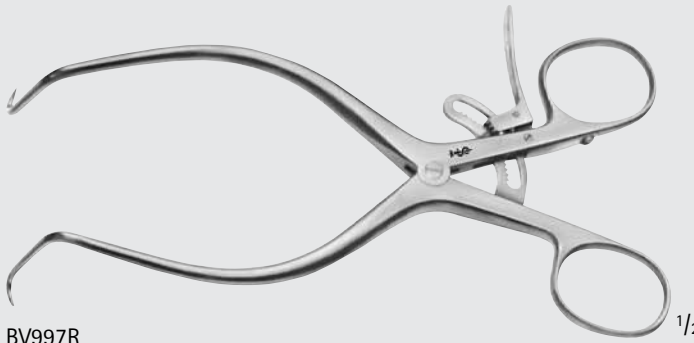

BV997R

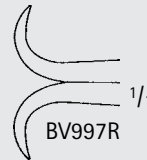

BV997R

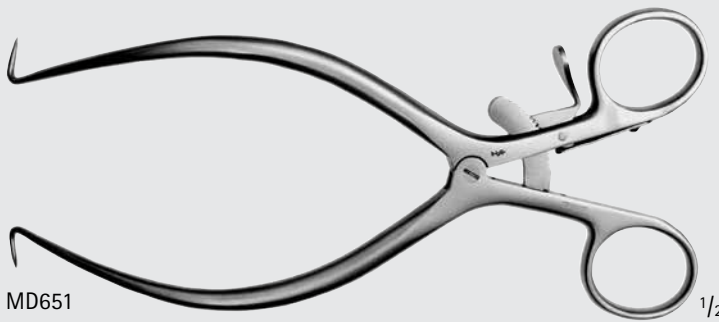

MD651



MD651



INCHES

# General Surgery

## Self Retaining Retractors



BV998R

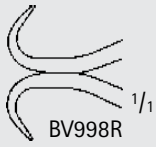

BV998R

### DEBAKEY Femur Retractor for Children

Catalog Number	Tip	Length (in.)
BV998R	SHARP	4

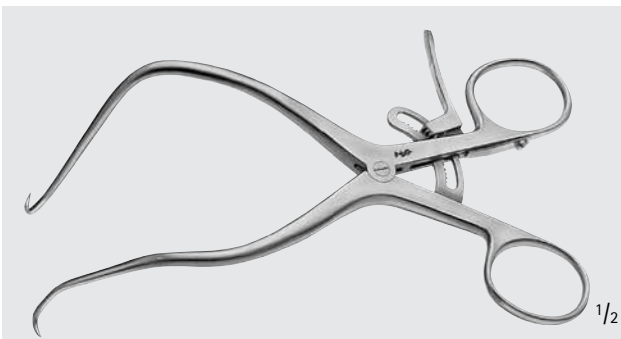

BV999R

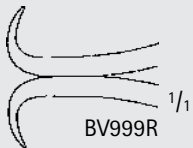

BV999R

### DEBAKEY Femur Retractor for Adults

Catalog Number	Tip	Length (in.)
BV999R	SHARP	5 1/2

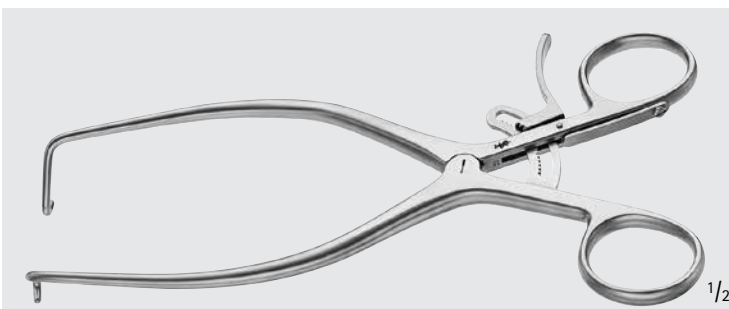

BV993R

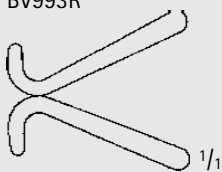

BV993R

### JACKSON-BURROWS Retractor

Catalog Number	Tip	Length (in.)
BV993R	BLUNT	7

# General Surgery

## Self Retaining Retractors



### HENLY Retractor

Catalog Number	Description	Blade Size (mm)	Blade Size (in.)	Length (in.)
BV120R	COMPLETE SET	-	-	7
MB842R	CENTER BLADE, SMALL	19 x 16	3/4 x 5/8	-
MB843R	CENTER BLADE, MEDIUM	25 x 16	1 x 5/8	-
MB844R	CENTER BLADE, LARGE	32 x 16	1 1/4 x 5/8	-
MB848R	CENTER BLADE, X-LARGE	76 x 16	3 x 5/8	-
MB845R	SIDE BLADE, PAIR (4 PRONGS)	25 x 25	1 x 1	-
MB846R	SIDE BLADE, PAIR (4 PRONGS)	51 x 25	2 x 1	-
MB847R	SIDE BLADE, PAIR (4 PRONGS)	76 x 22	3 x 1	-
MB849R	FRAME ONLY	-	-	7

BV120R Complete Set Includes:

- 1 Frame,
- 1 each of 4 Center Blades,
- 1 Pair of each of 3 Side Blades

Materials in set sold separately: MB842R-MB849R

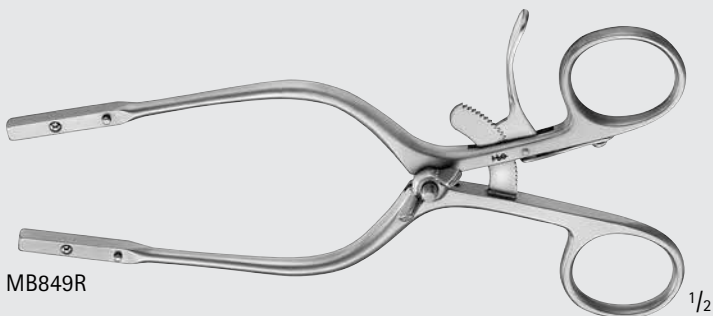
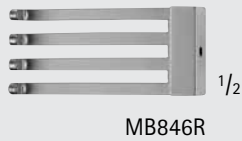
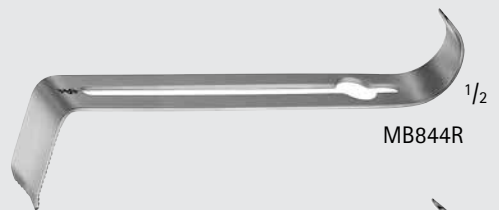
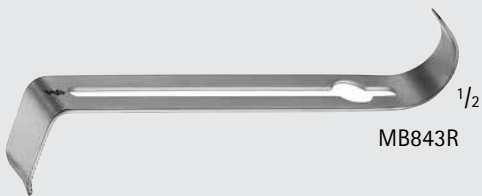
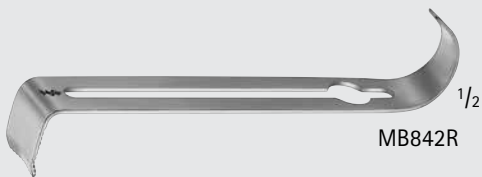

# General Surgery

## Rectal Specula Instruments

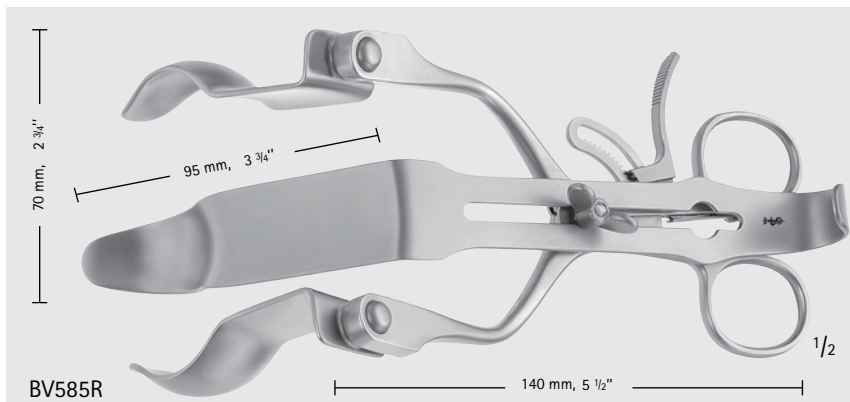

BV585R

### PARKS Rectal Spreader

Catalog Number	Item	Length (mm)
BV585R	COMPLETE SET	-
BV581R	SPREADER ONLY	-
BV582R	CENTER BLADE	-
BV583R	SIDE BLADE, PAIR	70
BV586R	SIDE BLADE, PAIR	90
BV584R	SIDE BLADE, PAIR	93
BV589R	SIDE BLADE, PAIR	150

Set Includes:

- 1 Spreader BV581R
- 1 Center Blade BV582R
- 2 Blades of each BV583R and BV584R

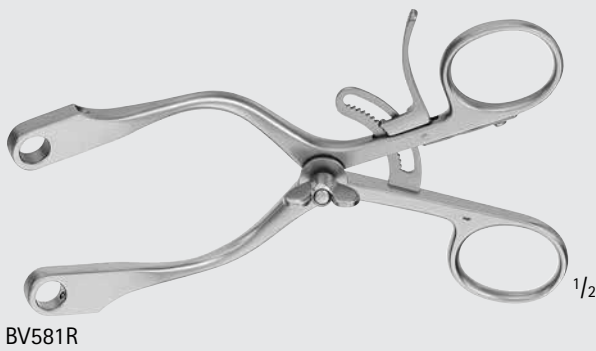

BV581R

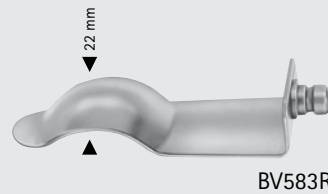

BV583R

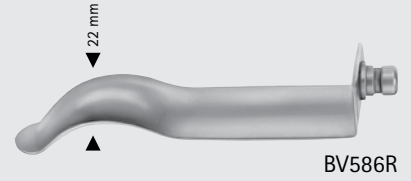

BV586R

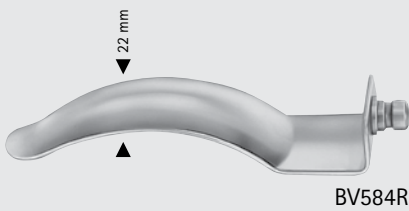

BV584R

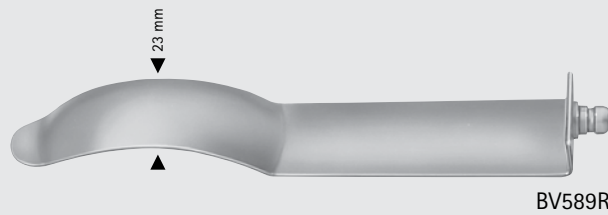

BV589R

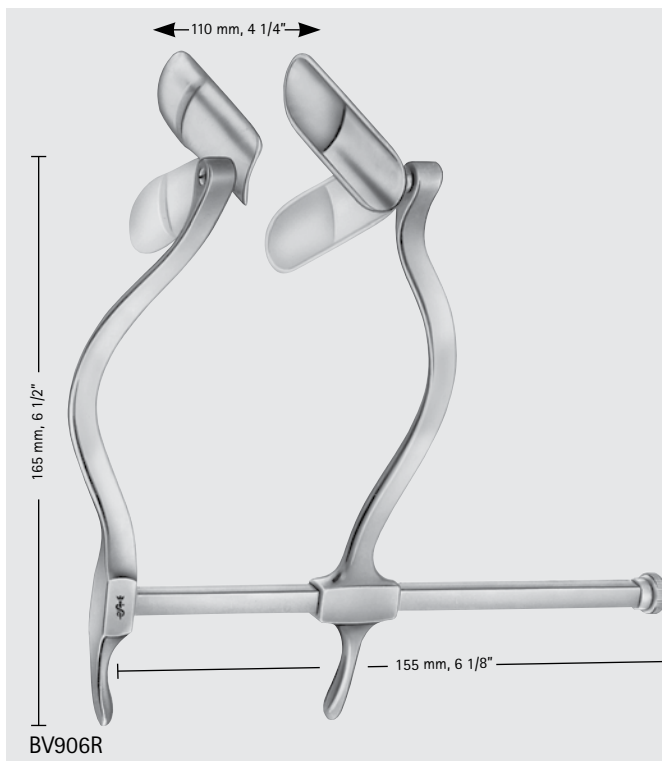

BV906R

### SMITH-BUIE Rectal Retractor

Catalog Number	Blade Size (mm)
BV906R	58 x 23

# General Surgery

## Rectal Specula Instruments

### ST. MARKS MODIFIED GIRONA Perineal Retractor

Catalog Number
BV907R

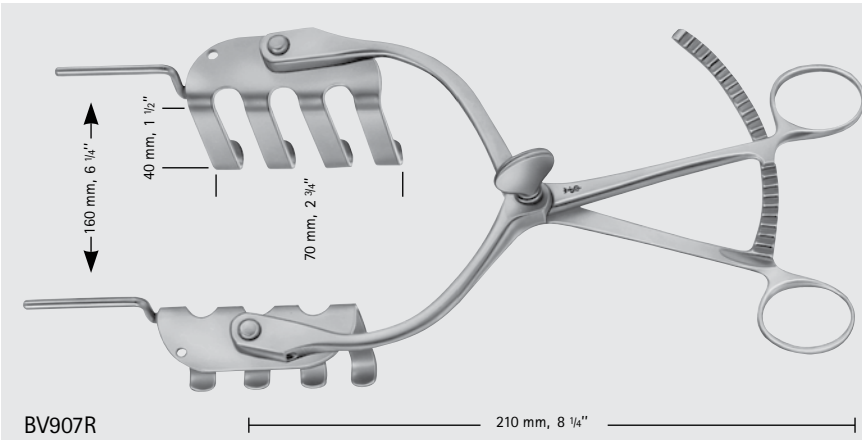

### CZERNY Rectal Speculum

Catalog Number	Length (in.)
EA800R	8 7/8

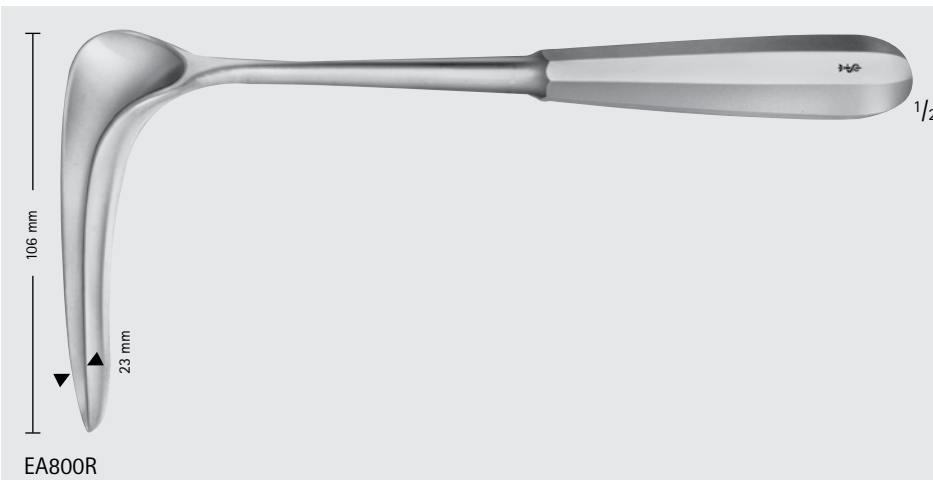

### SAWYER Retractor

Catalog Number	Size	Blade Size (mm)	Length (in.)
MB773R	SMALL	70 x 19	10 3/4
MB772R	MEDIUM	82 x 29	10 3/4
MG178R	LARGE	97 x 38	11 5/8



# General Surgery

## Rectal Specula Instruments

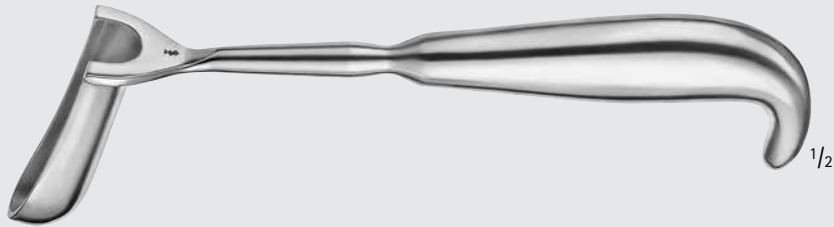

MB774R-MB776R

### HILL-FERGUSSON Rectal Retractor

Catalog Number	Blade Size (mm)	Length (in.)
MB775R	64 x 24	8 1/4
MB774R	76 x 35	8 1/4
MB776R	76 x 32	8 1/4



EA820R

### SIMS Rectal Speculum

Catalog Number	Blade	Length (in.)
EA820R	SOLID	6 1/4
EA821R	FENESTRATED	6 1/4



EA821R

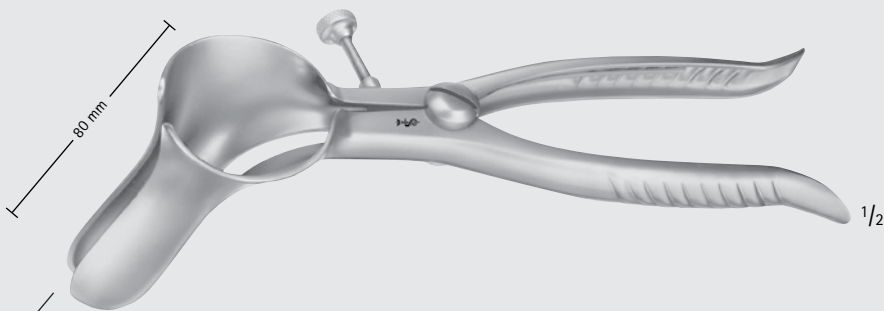

EA831R

### PRATT Rectal Speculum

Catalog Number	Length (in.)
EA831R	8

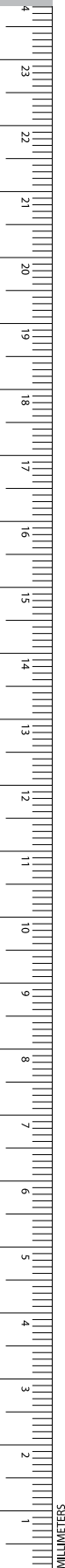

# General Surgery

## Rectal Specula Instruments

GENERAL SURGERY

### MATHIEU Rectal Speculum

Catalog Number	Length (in.)
EA843R	8 1/2

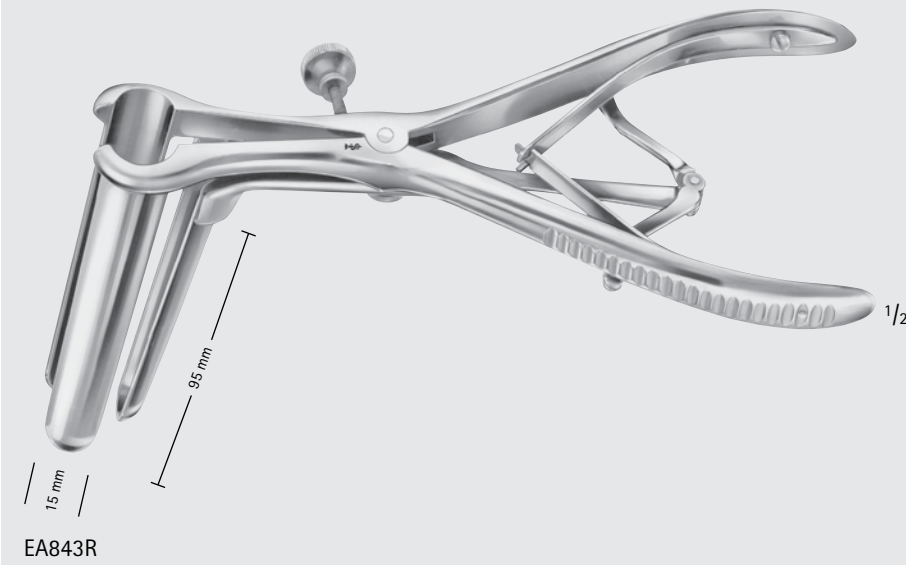

### IVES-FANSLER Anuscope

Catalog Number	Length (in.)
EA880R	5 3/4



### Rectal Speculum

Catalog Number	Length (in.)
MB274R	2 3/8



INCHES

# General Surgery

## Rectal Specula Instruments

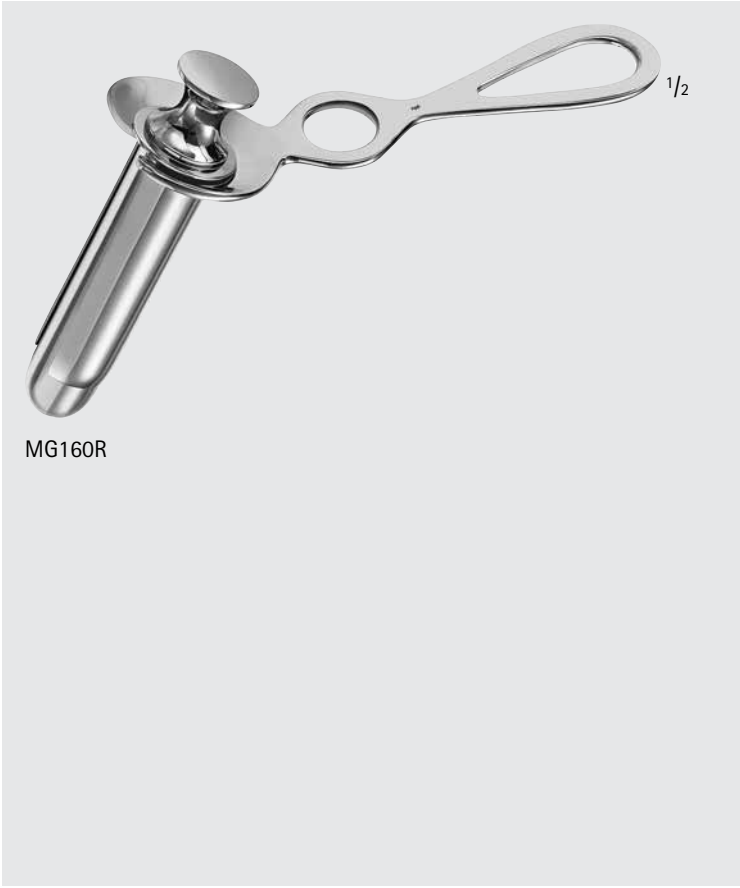

MG160R

### CHELSEA-EATON Anal Speculum

Catalog Number	Size	Diameter (mm)	Finish	Length (in.)
MG160R	SMALL	30	MIRROR FINISH	2 1/2

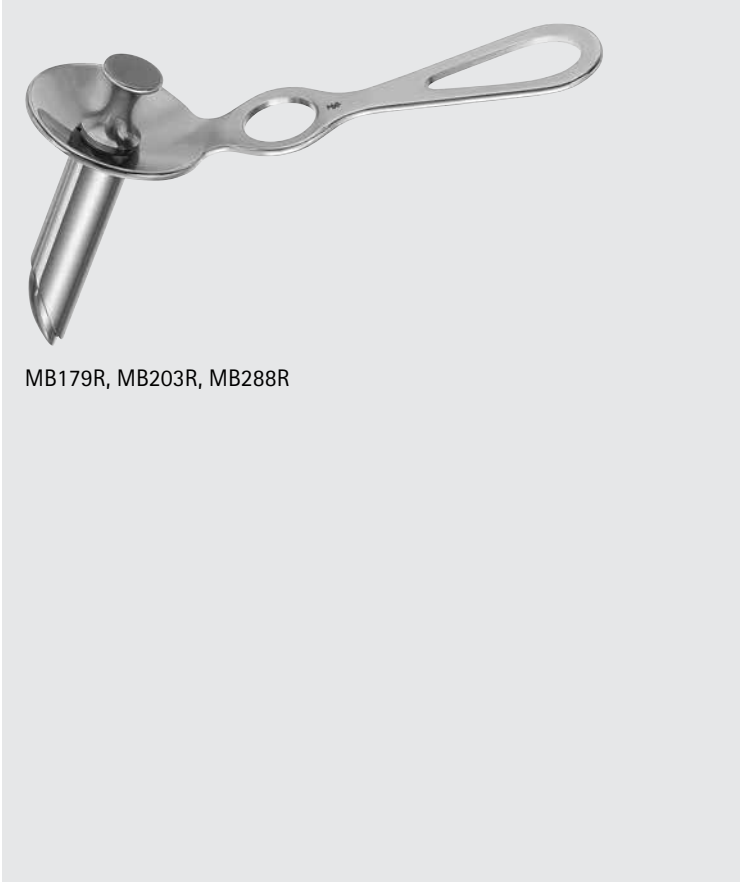

MB179R, MB203R, MB288R

### HIRSCHMANN Rectal Speculum

Catalog Number	Size	Blade Size (mm)
MB203R	SMALL	60 x 16
MB288R	MEDIUM	72 x 19
MB179R	LARGE	89 x 23

# General Surgery

## Rectal Specula Instruments



MB284R, MG162R-MG163R

### BRINKERHOFF Rectal Speculum

Catalog Number	Size	Diameter (in.)	Length (in.)
MG162R	SMALL	1/2 x 1	3 3/4
MG163R	MEDIUM	5/8 x 1	3 3/4
MB284R	LARGE	3/4 x 1 1/4	4 1/2



EA882R-EA887R

### KELLY Sphincteroscope

Catalog Number	Diameter (mm)	Working Length (mm)	Length (in.)
EA882R	21	54	6 1/4
EA887R	22	140	5 1/2
EA883R	25	50	6 1/4

Working Length



INCHES

# General Surgery

## Rectal Specula Instruments

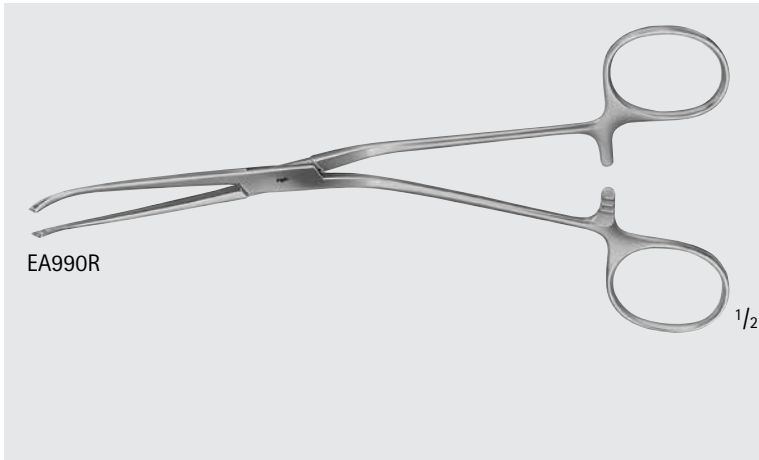
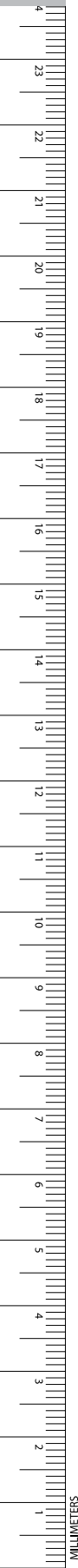

**MCGIVNEY Hemorrhoidal Forceps**

Catalog Number	Length (in.)
EA990R	7 1/4

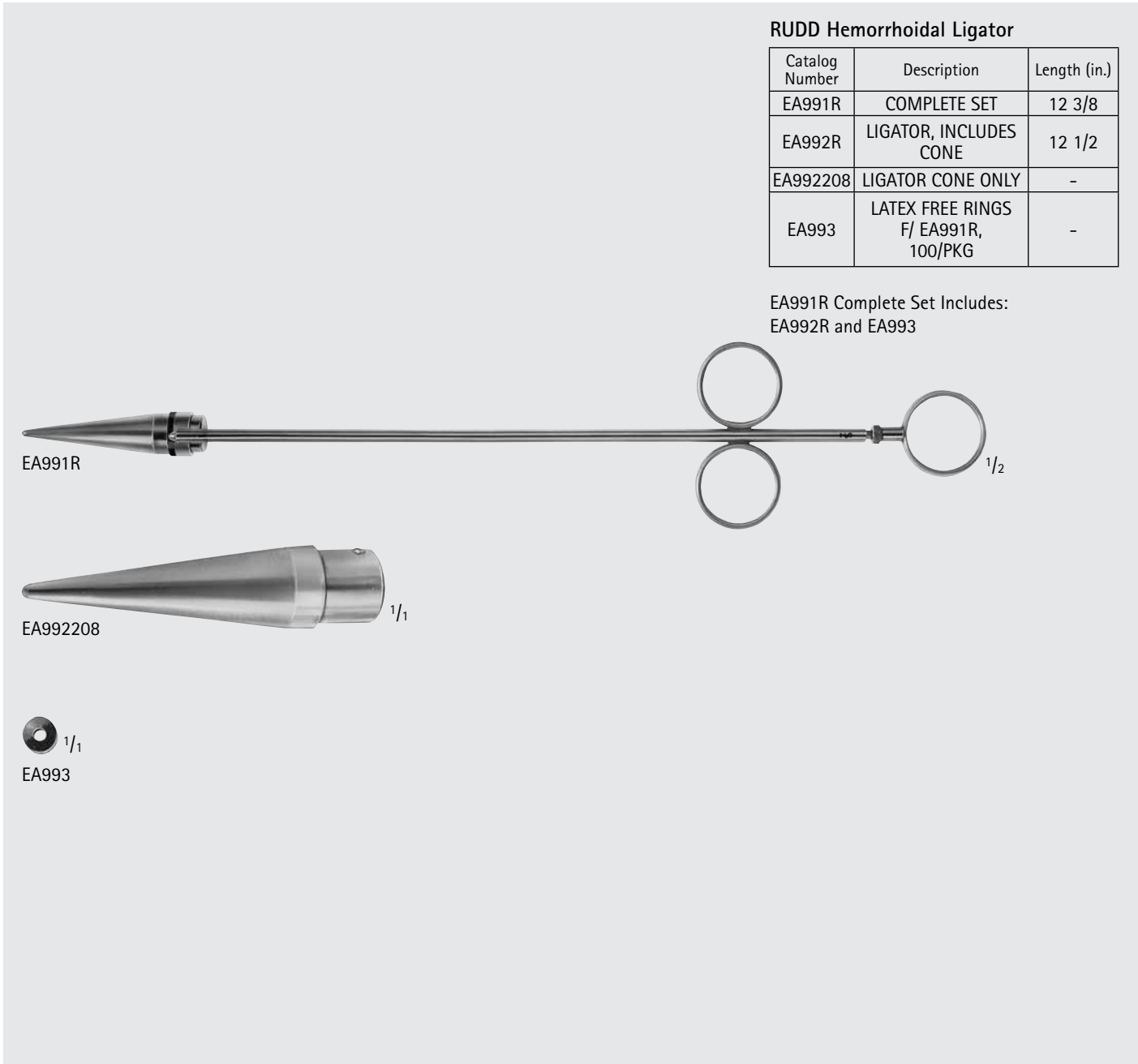

**RUDD Hemorrhoidal Ligator**

Catalog Number	Description	Length (in.)
EA991R	COMPLETE SET	12 3/8
EA992R	LIGATOR, INCLUDES CONE	12 1/2
EA992208	LIGATOR CONE ONLY	-
EA993	LATEX FREE RINGS F/ EA991R, 100/PKG	-

EA991R Complete Set Includes:  
EA992R and EA993

# General Surgery

## Rectal Specula Instruments

GENERAL  
SURGERY



MB892R

STEWART Crypt Hook

Catalog Number	Length (in.)
MB892R	9



MB892R



# General Surgery

## Probes, Dilators and Scoops



### BAKES Bile-Duct Dilator

Catalog Number	Tip Size (mm)	Length (in.)
EB061R	1	12 3/8
EB062R	2	12 3/8
EB063R	3	12 3/8
EB064R	4	12 3/8
EB065R	5	12 3/8
EB066R	6	12 1/2
EB067R	7	12 1/2
EB068R	8	12 1/2
EB069R	9	12 1/2
EB070R	10	12 1/2
EB071R	11	12 1/2
EB072R	12	12 1/2
EB073R	13	12 1/2
EB074R	SET, 3-11 mm	-



EB061R-EB074R

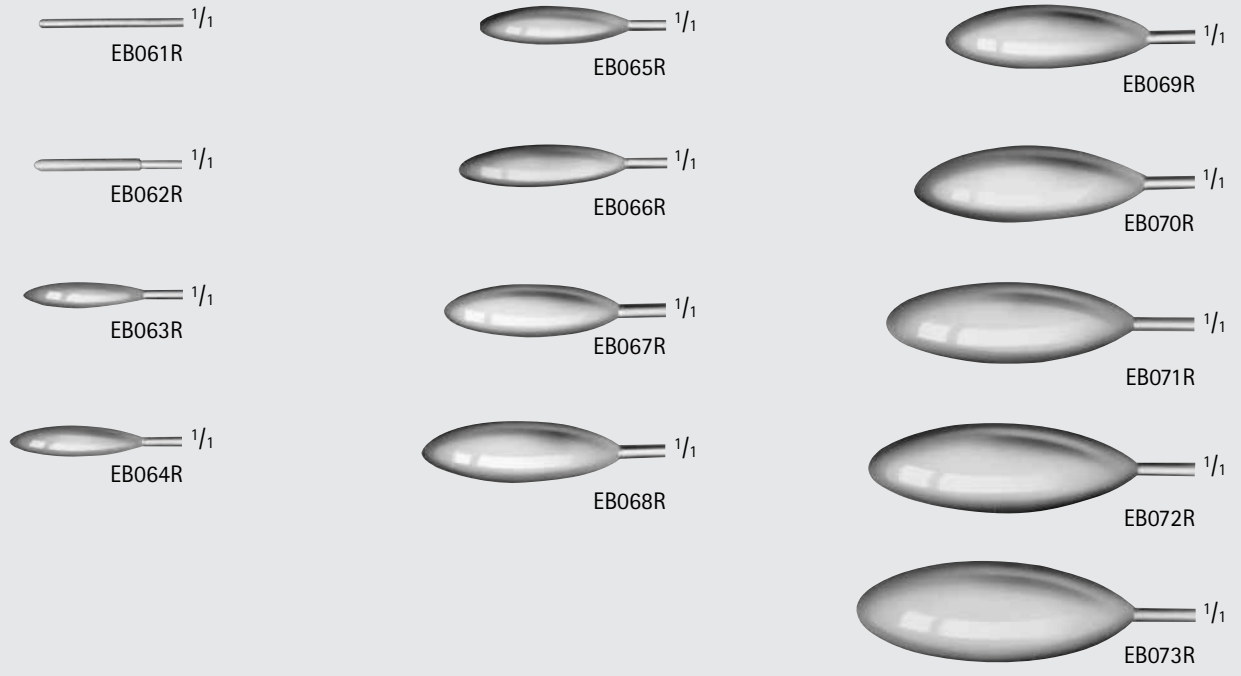

LUER-KOERTE Scoops, Malleable Shaft

Catalog Number	Tip Size (mm)	Length (in.)
EB168R	2.8	12 3/4
EB169R	3.4	12 3/4
EB170R	4.3	12 3/4
EB171R	5.5	12 3/4
EB172R	6.7	12 3/4
EB173R	8.0	12 3/4
EB174R	11.0	12 3/4
EB175R	15.0	12 3/4



EB168R-EB175R

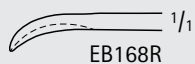

EB168R

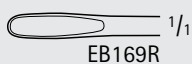

EB169R



EB170R

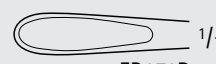

EB171R



EB172R

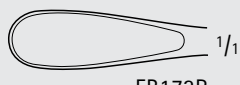

EB173R



EB174R



EB175R



BN003R-BN006R



BN003R-BN006R

Director W/ Tongue

Catalog Number	Blade Shape	Length (in.)
BN003R	STR	5 1/8
BN004R	STR	5 3/4
BN006R	STR	6 1/4



BN010R

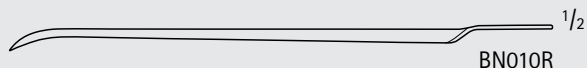

BN010R

DOYEN Director W/ Tongue

Catalog Number	Blade Shape	Length (in.)
BN010R	CVD	5 3/4

# General Surgery

## Probes, Dilators and Scoops



**Grooved Director W/ Tongue**

Catalog Number	Length (in.)
MB336R	4 $1/2$

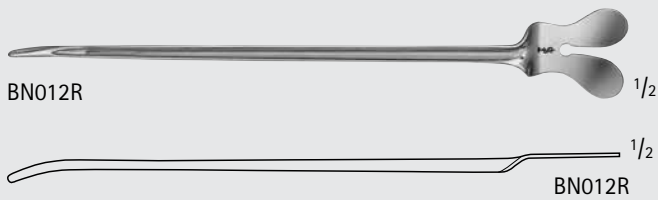

**NELATON Director**

Catalog Number	Blade Shape	Length (in.)
BN012R	CVD	6 $1/4$

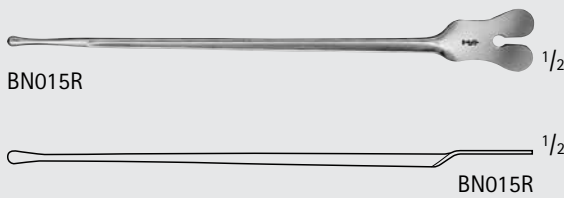

**Director, W/ Probe Tip & Tongue**

Catalog Number	Diam. of Tip (mm)	Blade Shape	Length (in.)
BN015R	3.3	STR	5 $1/2$

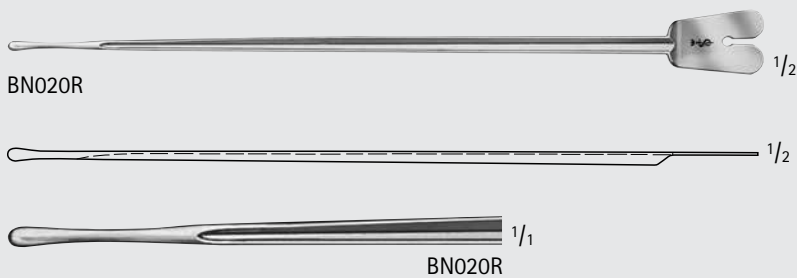

**BRODIE Director, W/ Probe Tip & Tongue**

Catalog Number	Diam. of Tip (mm)	Blade Shape	Length (in.)
BN020R	3.5	STR	7 $7/8$

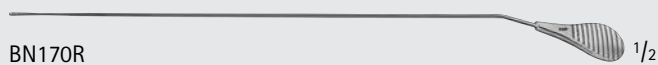

**Probe**

Catalog Number	Diam. of Tip (mm)	Length (in.)
BN170R	1.4	6 $1/4$

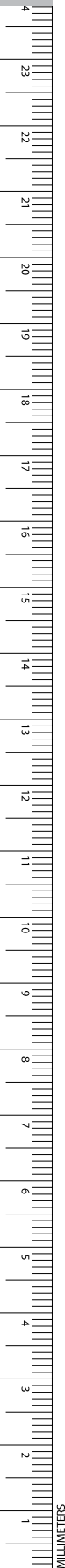

LOCKHART-MUMMERY Fistula Probe

Catalog Number	Blade Shape	Length (in.)
BN021R	#1-STR	6 1/2
BN022R	#2-SLT-CVD	6 1/2
BN023R	#3-CVD	6 1/2
BN024R	#4-HVY-CVD	6 1/2

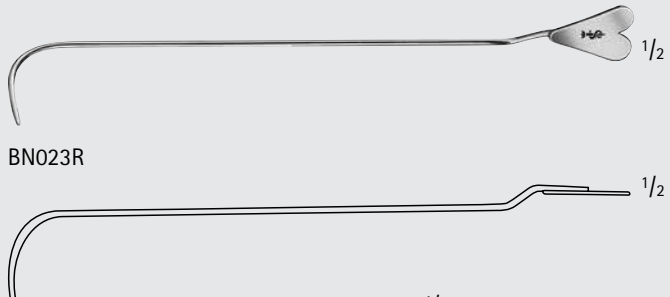
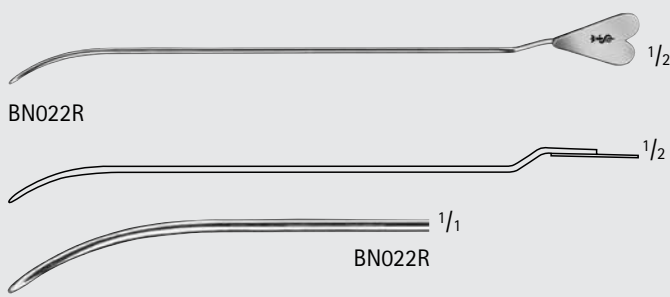
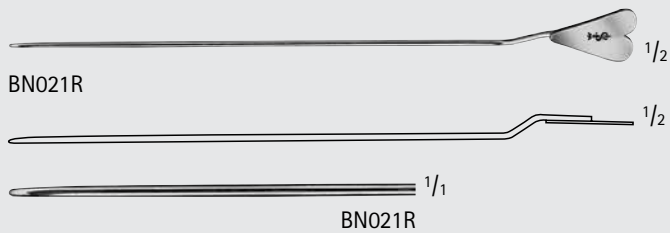

# General Surgery

## Probes, Dilators and Scoops



MG168R-MG169R

### BUIE Fistula Probe

Catalog Number	Description	Length (in.)
MG168R	LIGHT	6 1/2
MG169R	HEAVY	6 1/2



BN034R-BN040R, MB603R

### Probe W/ Eye

Catalog Number	Tip Size (mm)	Length (in.)
MB603R	1.5	5
BN034R	2.5	5 3/4
BN036R	2.5	6 1/4
BN040R	3	7 7/8



MG571

### Probe W/ Eye, Silver

Catalog Number	Tip Size (mm)	Length (in.)
MG571	1.75	4 1/2



BN054R



BN063R-BN070R

### Myrtle Leaf Probe

Catalog Number	Tip Size (mm)	Length (in.)
BN054R	1.5	5 3/4
BN063R	2	5 1/8
BN064R	2	5 3/4
BN066R	2	6 1/4
BN068R	2	7
BN070R	2	7 7/8

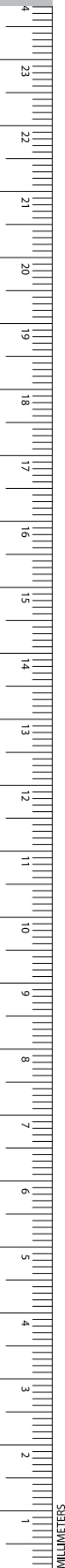

BN104R-BN150R



**Double Ended Probe**

Catalog Number	Tip Size (mm)	Length (in.)
BN104R	1.0	5 3/4
BN113R	1.5	5 1/8
BN114R	1.5	5 3/4
BN116R	1.5	6 1/4
BN118R	1.5	7
BN120R	1.5	7 7/8
BN125R	1.5	9 3/4
BN134R	2.0	5 3/4
BN136R	2.0	6 1/4
BN138R	2.0	7
BN140R	2.0	7 7/8
BN150R	2.0	11 3/4

BN090R



**Double Ended Probe W/ Eye, Malleable**

Catalog Number	Tip Size (mm)	Length (in.)
BN090R	3.0	7 1/2
BN095	3.5	9 3/4
BN096	3.5	11 3/4

BN095-BN096



**PRATT Rectal Probe, Malleable**

Catalog Number	Tip Size (mm)	Length (in.)
MB486	2.0	10

MB486

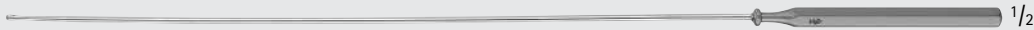

**Probe**

Catalog Number	Tip Size (mm)	Length (in.)
BN101R	2.0	11 3/4

BN101R

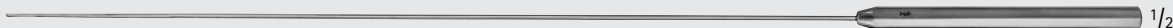

INCHES

# General Surgery

## Probes, Dilators and Scoops



### FERGUSSON Gall Stone Scoop, Double Ended

Catalog Number	Size	Length (in.)
MB697R	SMALL	9 1/2
MB698R	MEDIUM	9 1/2
MB699R	LARGE	9 1/2



MB697R-MB699R



MB697R-MB699R

### BARR Fistula Probe, Double Ended

Catalog Number	Length (in.)
MG170R	6 5/8



MG170R

### PRATT Fistula Probe, Crypt Hook

Catalog Number	Length (in.)
EA890R	9 1/2



EA890R



**ROSSER Crypt Hook**

Catalog Number	Length (in.)
MG165R	6 5/8

**DESJARDINS Gall Duct Probe, Flexible**

Catalog Number	Tip Size (mm)	Length (in.)
EB101R	3.8	11 1/4
EB102R	4.3	11 1/4
EB103R	6.8	11 1/4

**DESJARDINS Gall Stone Scoop**

Catalog Number	Tip Size (mm)	Length (in.)
EB111R	6	11 3/4
EB112R	7	11 3/4
EB113R	8	11 3/4
EB114R	9	11 3/4

**MAYO Gall Duct Probe**

Catalog Number	Tip Size (mm)	Tip	Length (in.)
E0005R	5	MALLEABLE	13

# General Surgery

## Scalpel Handles



### Micro Scalpel Handle

Catalog Number	Size	Length (in.)	Handle
MB104R	3H	4	Hexagonal
MB141R	3HL	6	Hexagonal
MB280R	3KM	3	Round Knurled
MB997R	3K	4	Round Knurled
MB281R	3KD	5	Round Knurled
BB046R	3K	5 1/4	Round Knurled
MB271R	3KL	6	Round Knurled
BB048R	3KL	6 1/8	Round Knurled
MG221R	3	7	Round Knurled
BB054R	3	7 7/8	Round Knurled
MG222R	3	8	Round Knurled
BB060R	3	17 3/4	Round Knurled
MB475R	COLLET		



MB104R



MB141R



MB280R



MB997R



MB281R



BB046R



MB271R



BB048R

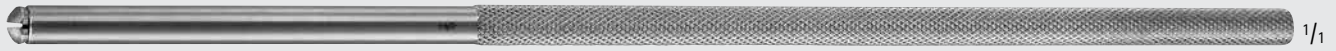

MG221R



BB054R



MG222R



BB060R



MB475R

MB475R

Replacement collet for MB104R, MB141R, MB271R, MB280R, MB281R and MB997R

**CORWIN Knife Handle**

Catalog Number	Length (in.)
MA203R	5 1/2



MA203R

**CASPAR Scalpel Handle**

Catalog Number	Length (in.)
BB052R	7



BB052R

**LANDOLT Scalpel Handle,  
F/ Microsurgery Blades**

Catalog Number	Length (in.)
BB053R	8 1/4
BB057R	9 3/4



BB053R



1/1



1/1

BB053R

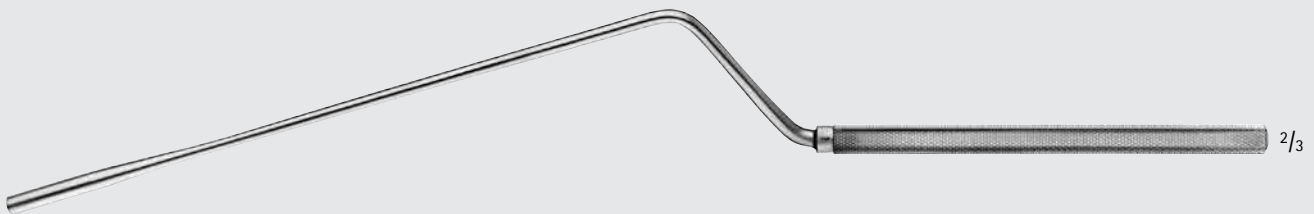

BB057R



BB331R



BB332R

**YASARGIL Arachnoid Blades  
F/ LANDOLT Scalpel Handles**

Catalog Number	Tip Size (mm)	Packaging
BB331R	1.5	10/BOX
BB332R	2.5	10/BOX



INCHES

# General Surgery

## Scalpel Handles



**Transsphenoidal Scalpel Handle, Bayonet, F/ Vertical and Lateral Blades**

Catalog Number	Length (in.)
BB071R	8 1/4

BB071R 2/3

BB071R 1/1

**Sterile Microsurgery Blades**

Catalog Number	Tip	Packaging
BB361R	SMALL CHISEL #61	10/BOX
BB362R	WIDE CHISEL #62	10/BOX
BB363R	SPEAR #63	1 EACH
BB364R	ROUND #64	10/BOX
BB365R	SMALL, SHARP #65	10/BOX
BB367R	CURVED, POINTED #67	10/BOX
BB368R	SMALL SICKLE #68	10/BOX

BB361R 1/1

BB362R 1/1

BB363R 1/1

BB364R 1/1

BB365R 1/1

BB367R 1/1

BB368R 1/1

**BARRON Scalpel Handle #3 F/ Blades nos. 10-15, 40, 42**

Catalog Number	Length (in.)
BB068R	5 1/8

BB068R 1/1

**Scalpel Handle #3, F/ Blades nos. 10-15, 40, 42**

Catalog Number	Length (in.)
BB070R	6 1/8

BB070R 1/1

# General Surgery

## Scalpel Handles

GENERAL SURGERY

### Scalpel Handle #3, F/ Blades nos. 10-15, 40, 42

Catalog Number	Size	Length (in.)
BB074R	#3	5
BB075R	#3L	8 1/4
BB175R	#3XL	9 3/4
MB917R	#3	16



### Scalpel Handle #3L, F/ Blades nos. 10-15, 40, 42

Catalog Number	Blade Shape	Length (in.)
MB127R	ANG	8



### Scalpel X-Long Handle, #3, F/ Blades nos. 10-15, 40, 42

Catalog Number	Blade Shape	Length (in.)
BB078R	STR	8 7/8



INCHES

# General Surgery

## Scalpel Handles



BB079R

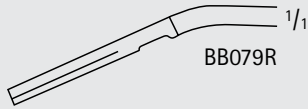

BB079R

Scalpel X-Long Handle, #3, F/ Blades nos. 10-15, 40, 42

Catalog Number	Blade Shape	Length (in.)
BB079R	ANG	8 7/8



BB080R

Scalpel Handle #4, F/ Blade nos. 18-36

Catalog Number	Length (in.)
BB080R	8 7/8

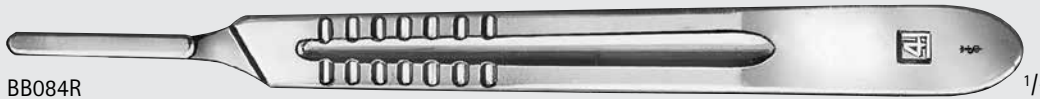

BB084R

Scalpel Handle #4, F/ Blades nos. 18-36

Catalog Number	Length (in.)
BB084R	5 1/4



BB085R

Scalpel Handle #4L, F/ Blades nos. 18-36

Catalog Number	Length (in.)
BB085R	8 1/2

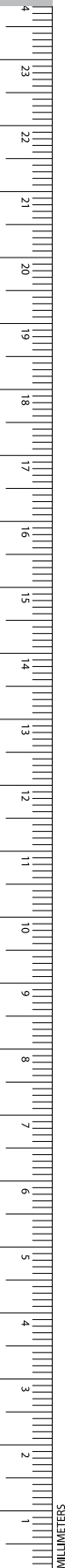

Scalpel Handle #4XL, F/ Blades nos. 18-36

Catalog Number	Length (in.)
BB087R	9 3/4



BB087R

2/3

Scalpel Handle #7, F/ Blades nos. 10-15, 40, 42

Catalog Number	Length (in.)
BB077R	6 1/4



BB077R

1/1

Scalpel Handle #9XL, F/ Blades nos. 18-36

Catalog Number	Length (in.)
MA202R	4 5/8
BB089R	5 3/4



MA202R

1/1



BB089R

1/1



INCHES

# General Surgery

## Scalpel Blades



BB510, 16600495



BB515, 16600525



BB511, 16600509



BB540 double cutting



BB512, 16600517



BB542 double cutting

### Sterile Scalpel Blade, For #3 Handle

Catalog Number		Blade Number	Packaging
Carbon	Stainless Steel		
BB510	16600495	#10	100/BOX
BB511	16600509	#11	100/BOX
BB512	16600517	#12	100/BOX
BB515	16600525	#15	100/BOX
BB540	-	#40	100/BOX
BB542	-	#42	100/BOX



BB520, 16600550



BB521, 16600568



BB522, 16600576



BB523, 16600584



BB524, 16600592



BB525, 16616634



BB536, 16615522

### Sterile Scalpel Blade, For #4 Handle

Catalog Number		Blade Number	Packaging
Carbon	Stainless Steel		
BB520	16600550	#20	100/BOX
BB521	16600568	#21	100/BOX
BB522	16600576	#22	100/BOX
BB523	16600584	#23	100/BOX
BB524	16600592	#24	100/BOX
BB525	16616634	#25	100/BOX
BB536	16615522	#36	100/BOX



BB500, 16600487

### Sterile Stitch Cutter Blade #3 Handle

Catalog Number		Packaging
Carbon	Stainless Steel	
BB500	16600487	100/BOX

GENERAL SURGERY

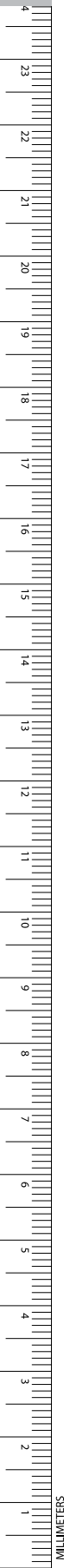

# General Surgery

## Sterile Scalpels With Plastic Handle

GENERAL SURGERY



BA210-5518059

1/2

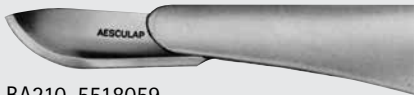

BA210, 5518059

1/1



BA211, 5518040

1/1



BA212, 5518105

1/1



BA215, 5518032

1/1



BA218

1/1



BA219

1/1



BA220, 5518067

1/1



BA221, 5518075

1/1



BA222, 5518083

1/1



BA223, 5518016

1/1



BA224, 5518091

1/1

### Sterile Scalpels W/ Plastic Handle and Blade Protector

Catalog Number		Size	Packaging
Carbon	Stainless Steel		
BA210	5518059	10	10/BOX
BA211	5518040	11	10/BOX
BA212	5518105	12	10/BOX
BA215	5518032	15	10/BOX
BA218	-	18	10/BOX
BA219	-	19	10/BOX
BA220	5518067	20	10/BOX
BA221	5518075	21	10/BOX
BA222	5518083	22	10/BOX
BA223	5518016	23	10/BOX
BA224	5518091	24	10/BOX



INCHES

# General Surgery

## Amputation and Autopsy Instruments



### LISTON Amputating Knife

Catalog Number	Blade Length (mm)	Blade Size (in.)
FH100R	130	5 1/8
FH101R	160	6 1/4
FH102R	190	7 1/2
FH103R	220	8 3/4



FH100R-FH103R

### CATLIN Amputating Knife, Double Cutting

Catalog Number	Blade Length (mm)	Blade Size (in.)
FH116R	160	6 1/4



FH116R

1/2

# General Surgery

## Amputation and Autopsy Instruments



### CHARRIÈRE Amputation Saw, 2 Blades

Catalog Number	Item	Blade Size (in.)	Blade Width (mm)	Total Length (in.)
FH300R	SAW COMPLETE W/2 BLADES	8 1/2	-	14
FH301C	CARBON STEEL BLADE	8 1/2	12	-
FH302C	CARBON STEEL BLADE	8 1/2	18	-



FH300R



FH301C-FH302C

### CHARRIÈRE Amputation Saw

Catalog Number	Item	Blade Size (in.)	Total Length (in.)
FH320R	SAW COMPLETE	7 1/4	10 1/2

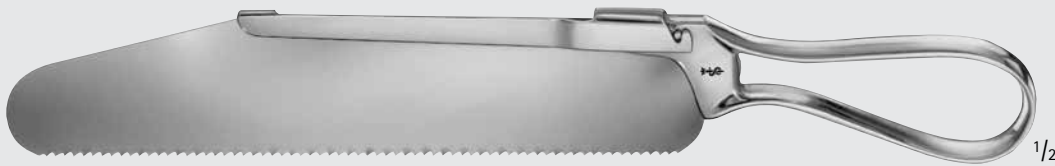

FH320R

### SATTERLEE Amputation Saw

Catalog Number	Item	Total Length (in.)
FH325R	SAW COMPLETE	11 1/2
FH326R	CARBON STEEL BLADE F/ FH325R	-

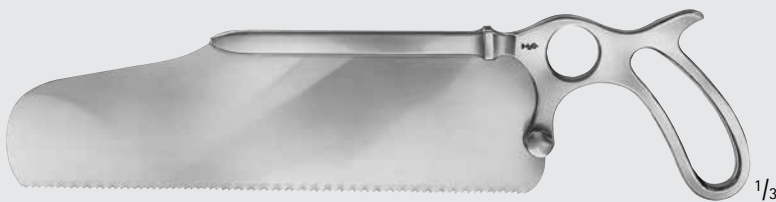

FH325R-FH326R

# General Surgery

## Amputation and Autopsy Instruments



### LANGENBECK Metacarpal Saw

Catalog Number	Length (in.)
FH335R	9 1/4



FH335R

### GIGLI Wire Saw

Catalog Number	Diameter (mm)	Wires	Sales Unit	Length (in.)
FH414	1.4	6	BOX OF 5	15 3/4
FH415	1.4	6	BOX OF 5	19 3/4
FH430R	1.8	4	BOX OF 5	19 3/4

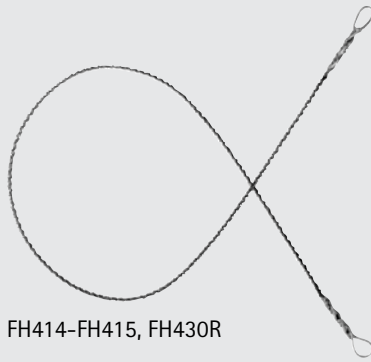

FH414-FH415, FH430R



FH414-FH415, FH430R

### GIGLI Saw Handle

Catalog Number	Packaging
MB986R	2/SET



MB986R

### GIGLI Hook Handle, F/ Wire Saws

Catalog Number	Packaging
FH480R	2/SET



FH480R

1/2

POOLE Suction Tube

Catalog Number	Handle	Tip Size (FR)	Hole in Tip Inner/Outer	Tube Diameter Inner/Outer	Length (in.)
MG272R	STR	30	YES/YES	5 mm/10 mm	8 1/2
GF862R	STR	30	YES/NO	5 mm/10 mm	8 7/8
MB927R	STR	30	YES/YES	4 mm/10 mm	14
MB928R	STR	30	YES/YES	4 mm/10 mm	16
MG271R	CVD	24	YES/NO	4 mm/8 mm	8 3/4
GF860R	CVD	21	YES/YES	4 mm/8 mm	8 7/8



MG272R



GF862R



MB927R-MB928R



MB927R



MB928R



MG271R



GF860R



# General Surgery

## Suction Tubes



Diam. 4 mm

Olive Diam. 9 mm

1/2

GF917R

Catalog Number	Tip Size (mm)	Tip Size (FR)	Length (in.)
GF917R	4	11	7 1/2

Olive Diam. 6 - 9 mm

1/2

GF919R

Catalog Number	Tip Size (mm)	Length (in.)
GF919R	5	7

Diam. 8 mm Outer Tube

Olive Diam. 9 - 11 mm

1/2

GF821R

Catalog Number	Tip Size (mm)	Length (in.)
GF821R	8.0	13 1/4

COOLEY Suction Tube W/ Detachable Tip

Catalog Number	Tip Size (mm)	Shaft	Length (in.)
GF822R	8.0	SLT-CVD	12 1/4
GF823R	9.0	CVD	11 5/8
GF824R	8.0	ANG	12 1/2
GF825R	9.0	90°	10 1/2



GF822R



GF823R

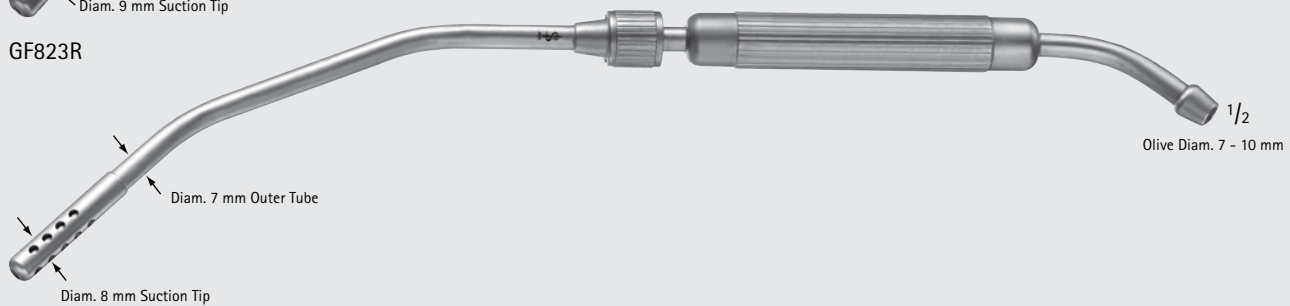

GF824R

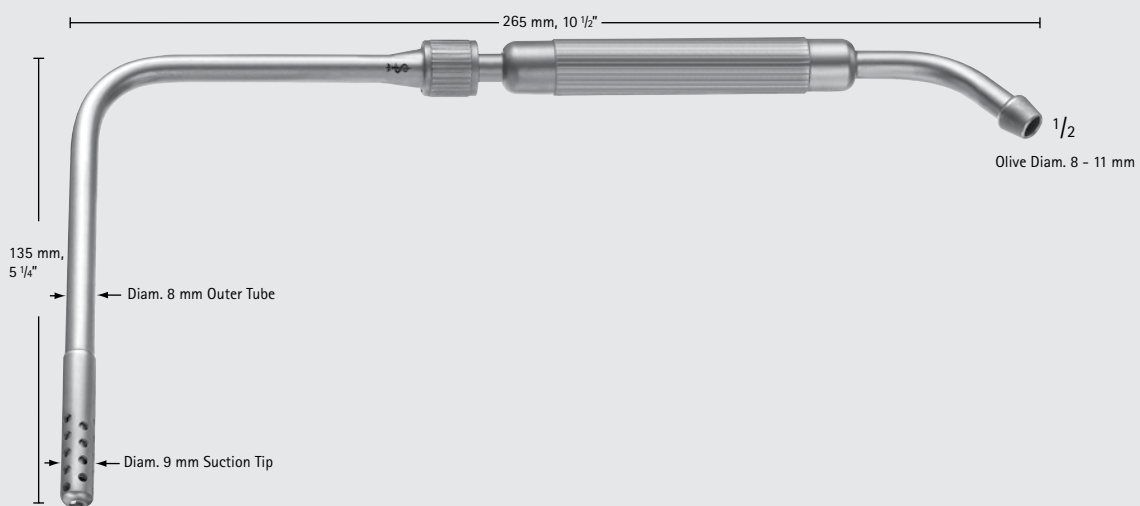

GF825R



INCHES

# General Surgery

## Suction Tubes

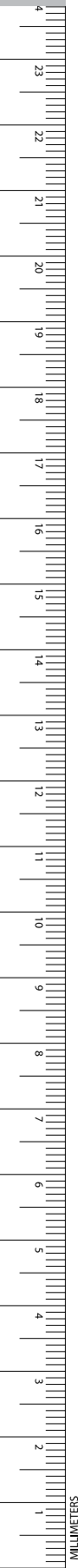

### Grafting Suction Tube

Catalog Number	Tip Size (mm)	Length (in.)
MB286R	3	9 1/2
MB287R	4	9 1/2



MB286R-MB287R

### DEBAKEY Suction Tube

Catalog Number	Tip Size (mm)	Length (in.)
GF946R	3	10 3/4
GF947R	5	6 1/4
GF948R	5	10 5/8
GF946205	REPLACEMENT TIP FOR GF946R	-



GF946R



Diam. 9 mm

GF946R



GF947R

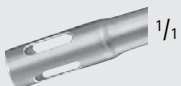

Diam. 5 mm

GF947R

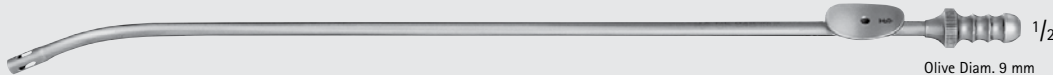

GF948R



Diam. 5 mm

GF948R

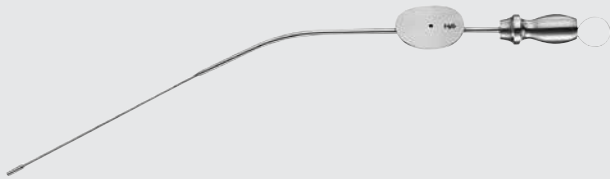

MF333R-MF347R

Atraumatic Suction Tube

Catalog Number	Tip Size (FR)	Working Length (in.)	Length (in.)
MF333R	3	3	6 1/4
MF334R	5	3	6 1/4
MF335R	7	3	6 1/4
MF336R	10	3	6 1/4
MF337R	12	3	6 1/4
MF338R	3	4	7 1/4
MF339R	5	4	7 1/4
MF340R	7	4	7 1/4
MF341R	10	4	7 1/4
MF342R	12	4	7 1/4
MF343R	3	5	8 1/4
MF344R	5	5	8 1/4
MF345R	7	5	8 1/4
MF346R	10	5	8 1/4
MF347R	12	5	8 1/4

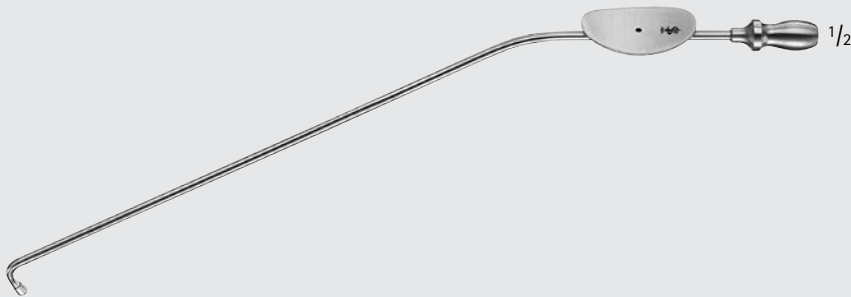

MF106R-MF111R



MF106R-MF108R



MF109R-MF111R

Atraumatic Suction Tube

Catalog Number	Tip	Tip Size (FR)	Length (in.)
MF106R	90° DOWN	5	8 1/2
MF107R	90° DOWN	7	8 1/2
MF108R	90° DOWN	10	8 1/2
MF109R	90° UP	5	8 1/2
MF110R	90° UP	7	8 1/2
MF111R	90° UP	10	8 1/2



INCHES

# General Surgery

## Suction Tubes

### YANKAUER Suction Tube

Catalog Number	Description	Tip Opening (mm)	Length (in.)
GF944R	-	2.0	11 1/4
OM671R	-	4.8	11 1/4
MB919R	-	2.0	12
MG092R	W/ VALVE	2.0	13 1/4
MB051R	-	2.0	14
MB920R	W/ VALVE	2.0	16
GF944200	REPLACEMENT TIP F/ GF944R	-	-
OM671200	REPLACEMENT TIP F/ OM671R	-	-
MB051200	REPLACEMENT TIP F/ MB051R, MB053R, MG919R, MG920R	-	-
MG092200	REPLACEMENT TIP F/ MG092R	-	-

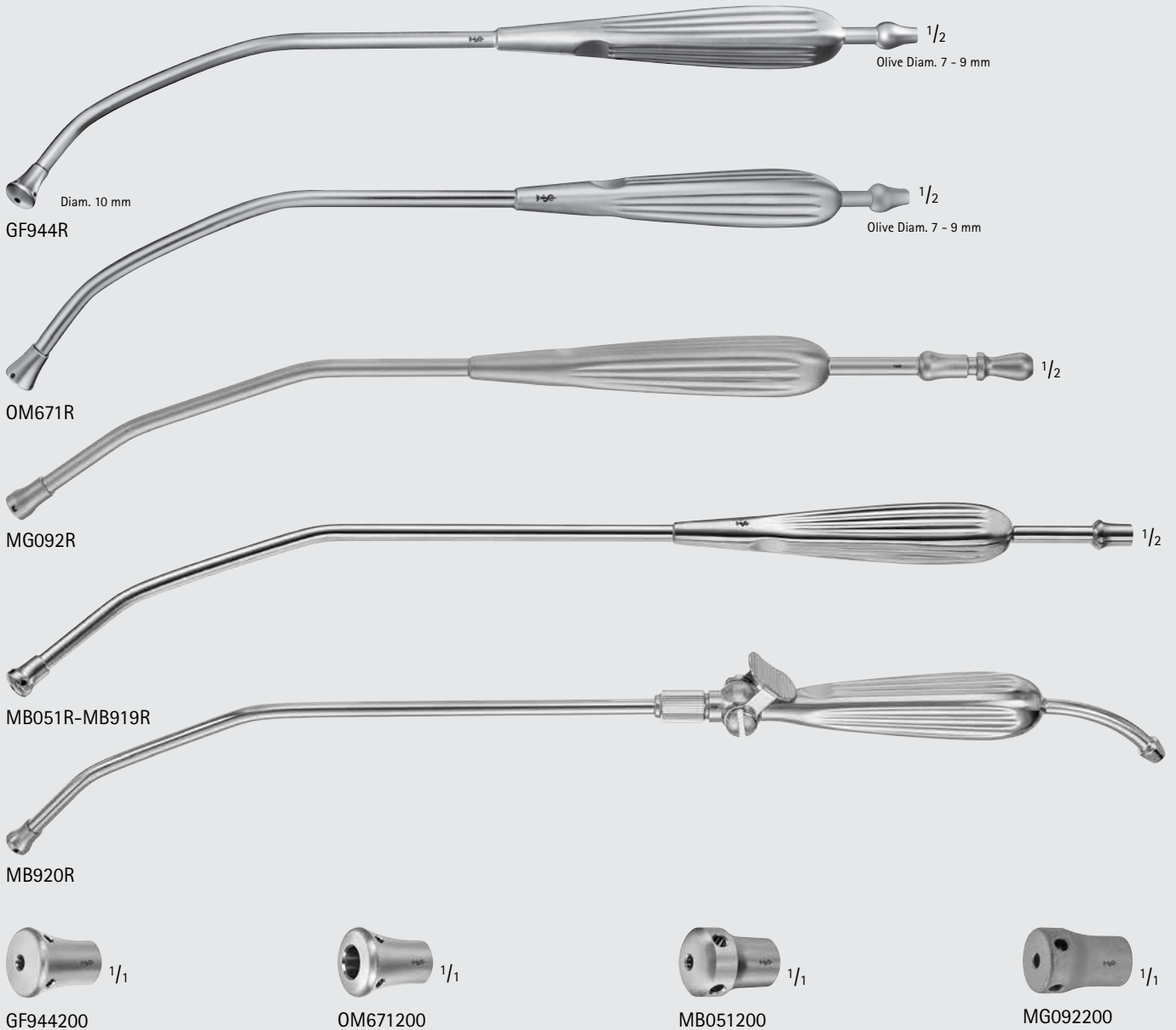



MB052R

**YANKAUER Suction W/ Thumb Control**

Catalog Number	Description	Length (in.)
MB052R	HANDLE W/ THUMB CONTROL	6 7/8
MB053R	SUCTION TUBE, CHROME PLATED	6 5/8

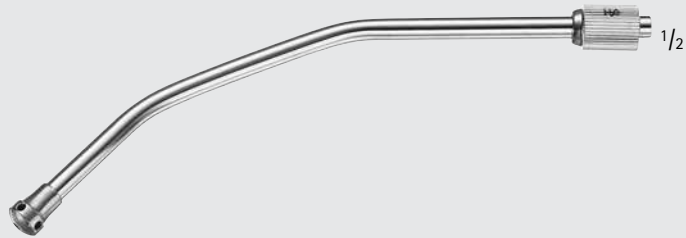

MB053R

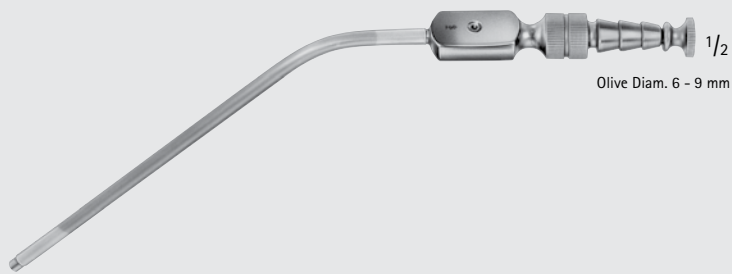

GF933R

**FERGUSSON Suction Tube**

Catalog Number	Tip	Tip Size (mm)	Length (in.)
GF933R	ROUND	4	7



# General Surgery

## Suction Tubes

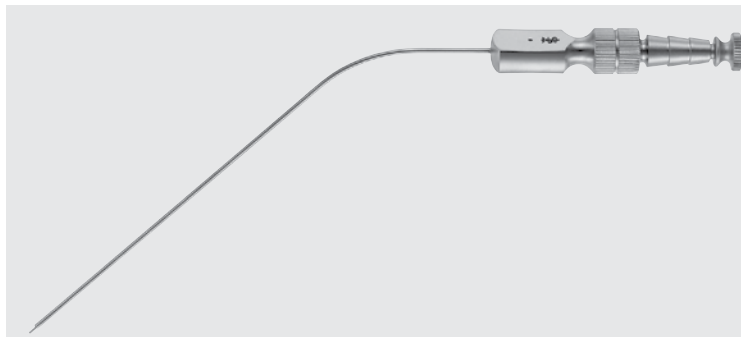

GF350R-GF385R

### FERGUSSON Suction Tube, Luer Hub

Catalog Number	Diameter (mm)	Working Length (in.)	Length (in.)
GF350R	1.5	4 1/4	7 3/4
GF351R	2.0	4 1/4	7 3/4
GF352R	2.5	4 1/4	7 3/4
GF353R	3.0	4 1/4	7 3/4
GF354R	4.0	4 1/4	7 3/4
GF355R	5.0	4 1/4	7 3/4
GF360R	1.5	5 1/8	8 1/2
GF361R	2.0	5 1/8	8 1/2
GF362R	2.5	5 1/8	8 1/2
GF363R	3.0	5 1/8	8 1/2
GF364R	4.0	5 1/8	8 1/2
GF365R	5.0	5 1/8	8 1/2
GF370R	1.5	6 1/4	9 5/8
GF371R	2.0	6 1/4	9 5/8
GF372R	2.5	6 1/4	9 5/8
GF373R	3.0	6 1/4	9 5/8
GF374R	4.0	6 1/4	9 5/8
GF375R	5.0	6 1/4	9 5/8
GF380R	1.5	7 7/8	11
GF381R	2.0	7 7/8	11
GF382R	2.5	7 7/8	11
GF383R	3.0	7 7/8	11
GF384R	4.0	7 7/8	11
GF385R	5.0	7 7/8	11

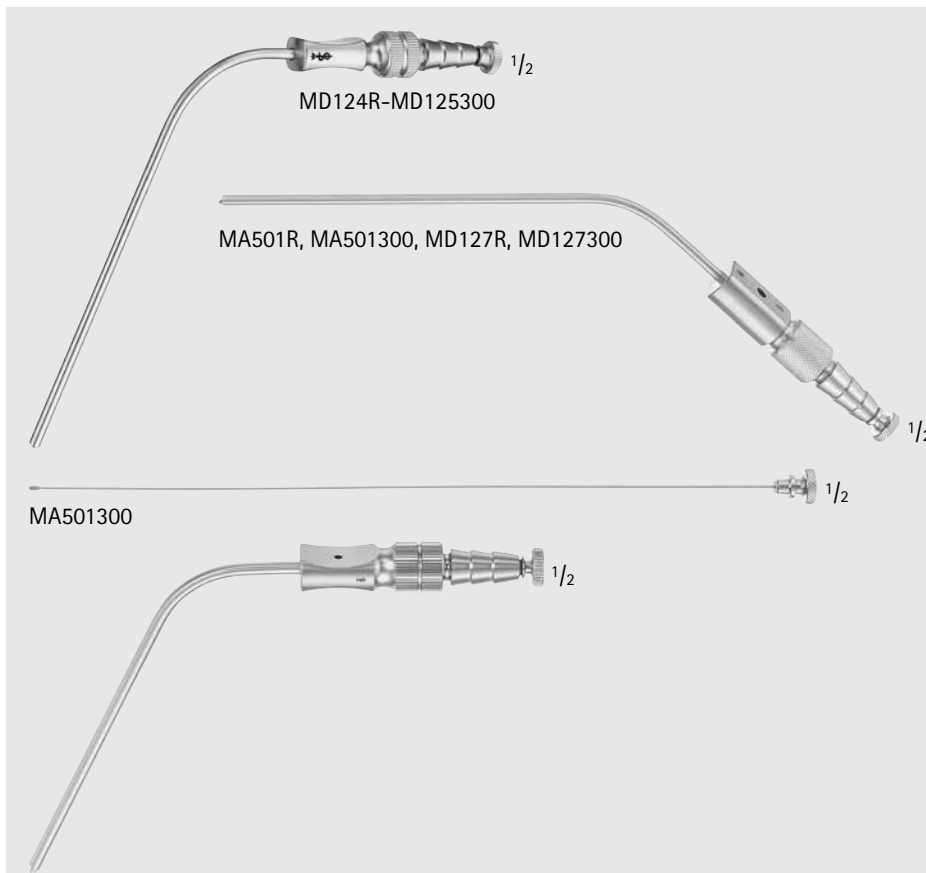

### FRAZIER Suction Tube

Catalog Number	Tip Size (FR)	Description	Working Length (in.)
MD124R	7		4 1/4
MD124300	7	SUCTION STYLET W/ OLIVE TIP FOR MD124R	
MD125R	7		4 1/4
MD125300	8	SUCTION STYLET W/ OLIVE TIP FOR MD125R	
MA501R	9		4 1/4
MA501300		SUCTION STYLET W/ OLIVE TIP FOR MA501R	
MD127R	10		4 1/4
MD127300	10	SUCTION STYLET W/ OLIVE TIP FOR MD127R	
MA499R	11		4 1/4
MA499300	11	SUCTION STYLET W/ OLIVE TIP FOR MA499R	
MD129R	12		4 1/4
MD129300	12	SUCTION STYLET W/ OLIVE TIP FOR MD129R	



MF479R-MF489R, MF499R-MF508R

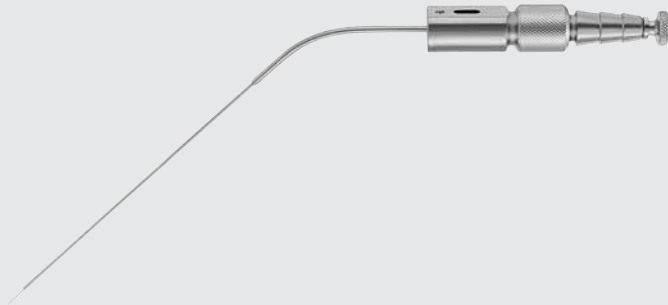

MF489R-MF498R, MF509R-MF518R

FRAZIER Slotted Suction Tube

Catalog Number	Tip Size (FR)	Shaft	Length (in.)
MF479R	3	STR	5 1/2
MF480R	4	STR	5 1/2
MF481R	5	STR	5 1/2
MF482R	6	STR	5 1/2
MF483R	7	STR	5 1/2
MF484R	8	STR	5 1/2
MF485R	9	STR	5 1/2
MF486R	10	STR	5 1/2
MF487R	11	STR	5 1/2
MF488R	12	STR	5 1/2
MF499R	3	STR	7
MF500R	4	STR	7
MF501R	5	STR	7
MF502R	6	STR	7
MF503R	7	STR	7
MF504R	8	STR	7
MF505R	9	STR	7
MF506R	10	STR	7
MF507R	11	STR	7
MF508R	12	STR	7
MF489R	3	ANG	5 1/2
MF490R	4	ANG	5 1/2
MF491R	5	ANG	5 1/2
MF492R	6	ANG	5 1/2
MF493R	7	ANG	5 1/2
MF494R	8	ANG	5 1/2
MF495R	9	ANG	5 1/2
MF496R	10	ANG	5 1/2
MF497R	11	ANG	5 1/2
MF498R	12	ANG	5 1/2
MF509R	3	ANG	7
MF510R	4	ANG	7
MF511R	5	ANG	7
MF512R	6	ANG	7
MF513R	7	ANG	7
MF514R	8	ANG	7
MF515R	9	ANG	7
MF516R	10	ANG	7
MF517R	11	ANG	7
MF518R	12	ANG	7



INCHES

# General Surgery

## Suction Tubes

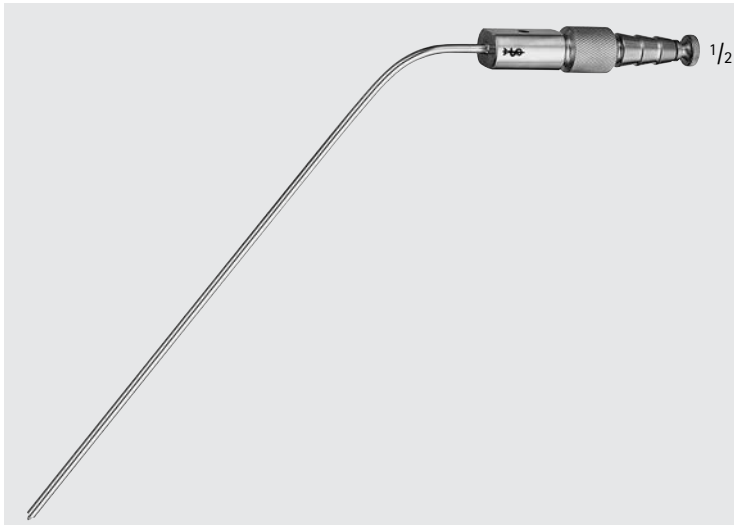

MD091-MD099

### FRAZIER Long-Suction Tube

Catalog Number	Tip Size (FR)	Length (in.)
MD091	3	6 1/2
MD092	5	6 1/2
MD093	6	6 1/2
MD094	7	6 1/2
MD095	8	6 1/2
MD096	9	6 1/2
MD097	10	6 1/2
MD098	11	6 1/2
MD099	12	6 1/2



GF923R-GF925R

### FRAZIER Suction Tube W/ Luer Hub

Catalog Number	Tip Size (FR)	Length (in.)
GF923R	9	7
GF925R	15	7

- Teardrop shaped thumb control for a very precise suction regulation
- Malleable material for individual forming of the suction hose
- Conical design of the tube prevents plugging
- Delivered with stylet

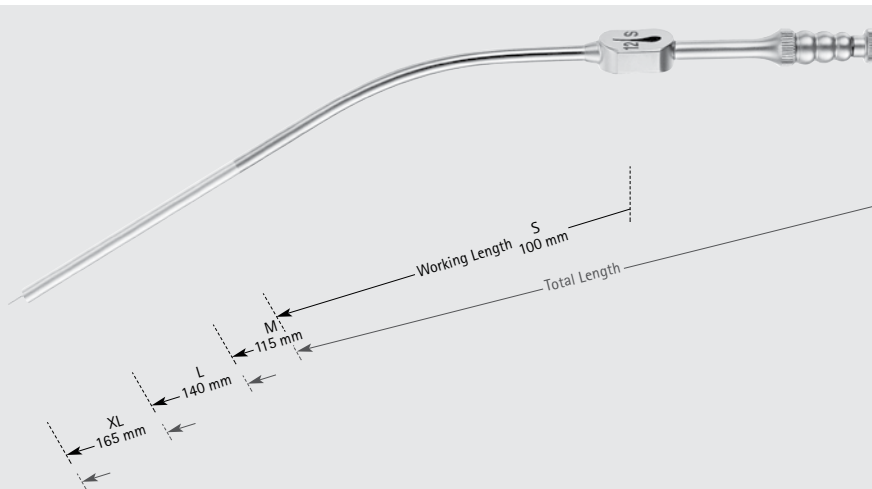

GF391R-GF429R

Suction Tube, Fukushima Style, W/ Tapered Teardrop Control

Catalog Number	Size	Tip Size (mm)	Tip Size (FR)	Working Length (in.)	Length (in.)
GF401R	S	1.0	3	4	6 1/2
GF402R	S	1.4	4	4	6 1/2
GF403R	S	1.7	5	4	6 1/2
GF404R	S	2.0	6	4	6 1/2
GF405R	S	2.3	7	4	6 1/2
GF406R	S	2.7	8	4	6 1/2
GF407R	S	3.0	9	4	6 1/2
GF408R	S	3.3	10	4	6 1/2
GF409R	S	4.0	12	4	6 1/2
GF391R	M	1.0	3	4 1/2	7
GF392R	M	1.4	4	4 1/2	7
GF393R	M	1.7	5	4 1/2	7
GF394R	M	2.0	6	4 1/2	7
GF395R	M	2.3	7	4 1/2	7
GF396R	M	2.7	8	4 1/2	7
GF397R	M	3.0	9	4 1/2	7
GF398R	M	3.3	10	4 1/2	7
GF399R	M	4.0	12	4 1/2	7
GF411R	L	1.0	3	5 1/2	8
GF412R	L	1.4	4	5 1/2	8
GF413R	L	1.7	5	5 1/2	8
GF414R	L	2.0	6	5 1/2	8
GF415R	L	2.3	7	5 1/2	8
GF416R	L	2.7	8	5 1/2	8
GF417R	L	3.0	9	5 1/2	8
GF418R	L	3.3	10	5 1/2	8
GF419R	L	4.0	12	5 1/2	8
GF421R	XL	1.0	3	6 1/2	9
GF422R	XL	1.4	4	6 1/2	9
GF423R	XL	1.7	5	6 1/2	9
GF424R	XL	2.0	6	6 1/2	9
GF425R	XL	2.3	7	6 1/2	9
GF426R	XL	2.7	8	6 1/2	9
GF427R	XL	3.0	9	6 1/2	9
GF428R	XL	3.3	12	6 1/2	9
GF429R	XL	4.0	12	6 1/2	9



# General Surgery

## Suction Tubes



GF980R

olive diam. 6 - 9 mm  
1/2

### LANDOLT Dissecting Suction Tube

Catalog Number	Tip	Tip Size (mm)	Length (in.)
GF980R	ANG, SHARP	3.2	7 7/8

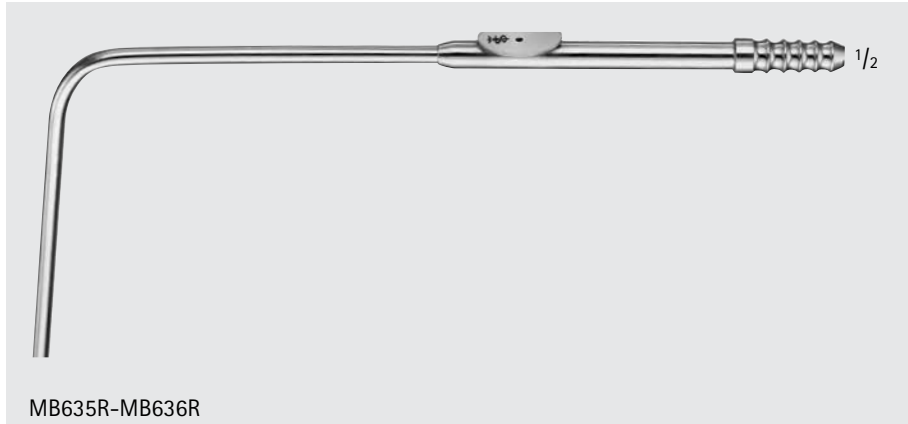

MB635R-MB636R

### SACHS Suction Tube

Catalog Number	Tip Size	Length (in.)
MB635R	SMALL	8 1/2
MB636R	LARGE	8 1/2

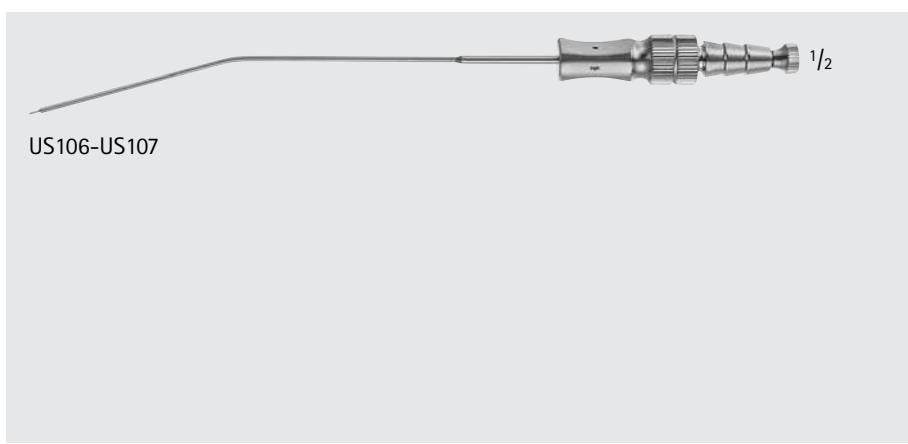

US106-US107

1/2

### PRIBRAM Suction Tube with Thumb Control

Catalog Number	Tip	Length (in.)
US106	16	5 1/2
US107	18	5 1/2

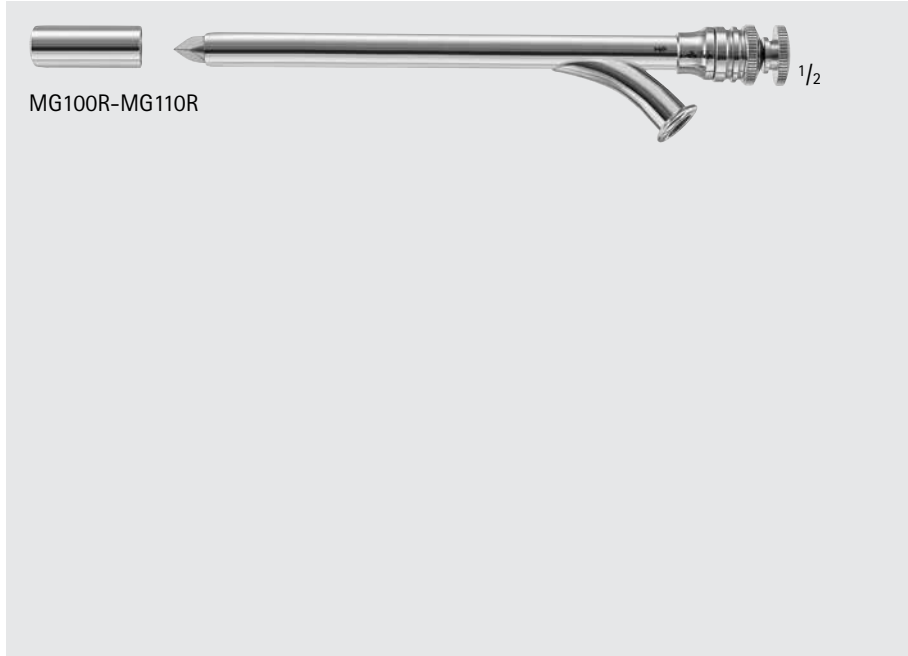

MG100R-MG110R

1/2

### OCHSNER Trocar

Catalog Number	Tip Size (FR)	Length (in.)
MG100R	10	6
MG101R	12	6
MG102R	14	6
MG103R	16	6
MG104R	18	6
MG105R	20	6
MG106R	22	6
MG107R	24	6
MG108R	26	6
MG109R	27	6
MG110R	28	6



AA804R-AA806R

Steel Ruler, Graduated In Millimeters and Inches

Catalog Number	Length (in.)
AA804R	6
AA805R	11 3/4
AA806R	19 3/4

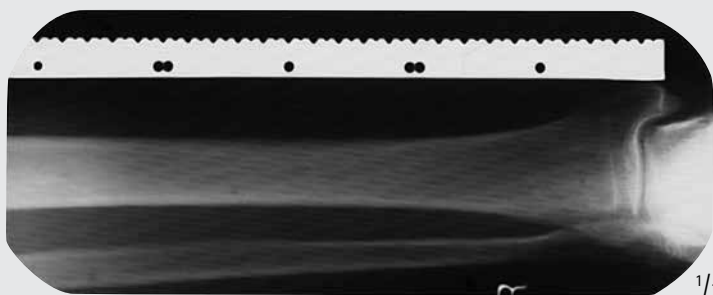

AA808R

Ruler, F/ X-Ray Work

Catalog Number	Length (in.)
AA808R	19 3/4

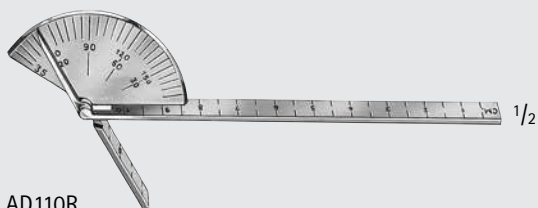

AD110R

Finger-Goniometer

Catalog Number	AD110R
----------------	--------

# General Surgery

## Accessories



MG001R-MG004R

### Surgical Spoon

Catalog Number	Size	Blade Size (mm)	Length (in.)
MG003R	SMALL	25	4 1/4
MG002R	MEDIUM	30	5 1/4
MG004R	MEDIUM-LARGE	35	6 1/4
MG001R	LARGE	40	7 1/2



783101-783102

1/2

### Staple Remover

Catalog Number	Description
783102	REUSABLE
783101	SINGLE USE (BOX OF 6)



MG377R-MG378R

### TAYLOR Percussion Hammer

Catalog Number	Size	Length (in.)
MG377R	SMALL	7
MG378R	LARGE	7 3/4



**Metal Sponge Bowl**

Catalog Number	Capacity (qts.)
US061	1
US060	1 1/2
US062	1 7/8



US060-US062

1/2

**Metal Cup**

Catalog Number	Item	Capacity (oz.)
US066	MEDICINE CUP	2
US063	IODINE CUP	6
US067	SOLUTION BASIN	12
US065	IODINE CUP	14
US064	GRADUATED MEASURE	32



US063-US067

1/2

**Kidney Tray**

Catalog Number	Length (in.)
JG504R	6 3/4
JG506R	9 3/4



JG504R-JG506R



INCHES

# General Surgery

GENERAL SURGERY

