





ENT-EAR

- Scissors536
- Needles 537 - 538
- Tissue, Dressing and Sponge Forceps 539 - 542
- Alligator Forceps 543 - 549
- Nippers, Crimping Forceps and Snares 550 - 553
- Hooks and Probes 554 - 555
- Retractors 556 - 557
- Picks 558 - 561
- Specula 562 - 567
- Cotton Applicators 568
- Knives 569 - 575
- Suction Irrigation 576 - 579
- Dissectors, Chisels and Gouges 580 - 581
- Elevators, Scrapers and Excavators 582 - 583
- Augers, Measurers and Rasps 584
- Curettes, Loops and Spoons 585 - 589
- Rongeurs 590
- Tuning Forks 591
- Miscellaneous 592 - 593

ENT-EAR

Scissors

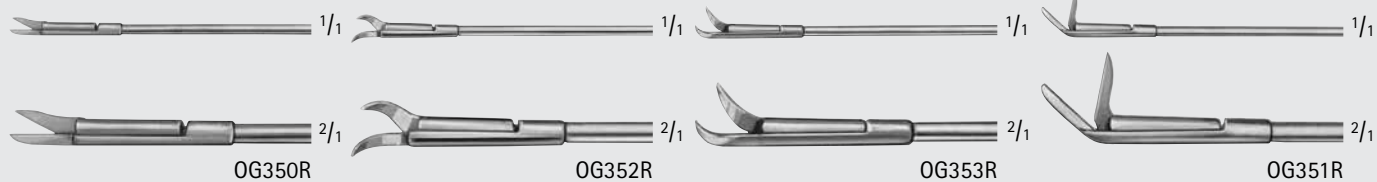
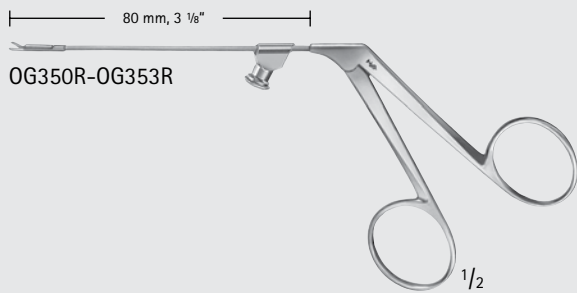

BELLUCCI Micro Scissors

Catalog Number	Tip	Blade	Working Length (in.)	Length (in.)
OG350R	S/S	STR	3 1/8	5 1/4
OG352R	S/S	CVD-LEFT	3 1/8	5 1/4
OG353R	S/S	CVD-RIGHT	3 1/8	5 1/4
OG351R	B/B	ANG-UP	3 1/8	5 1/4

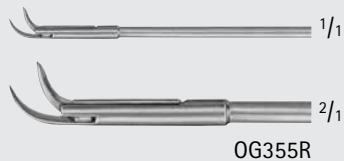
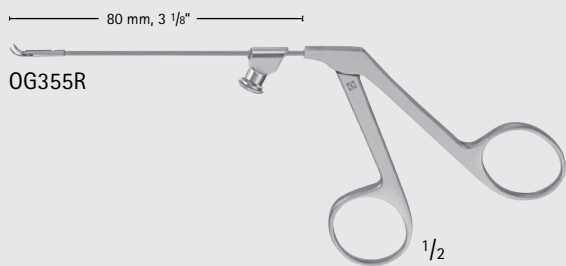
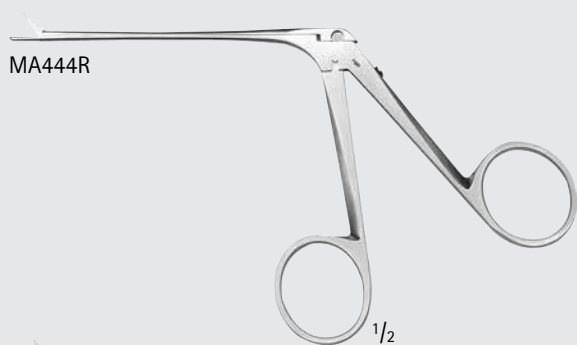

BELLUCCI Scissors

Catalog Number	Tip	Blade	Blade Size (mm)	Working Length (in.)	Length (in.)
MA444R	B/B	STR	7	3	5 1/4
OG355R	S/S	CVD-UP	-	3 1/8	5 1/4

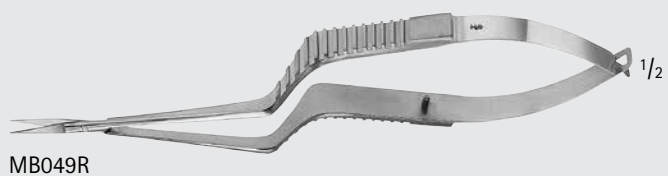

WIET Ear Scissors, Bayonet-Shaped

Catalog Number	Tip	Blade	Length (in.)
MB049R	S/S	STR	6 1/2



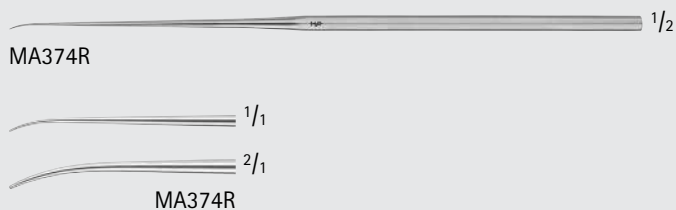

HOUSE Needle

Catalog Number	Tip	Blade Shape	Length (in.)
MA374R	DEL	CVD	6 $\frac{1}{2}$

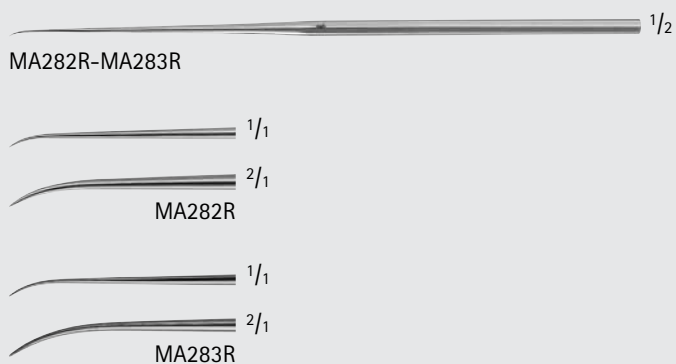

HOUSE Needle, Malleable

Catalog Number	Tip	Blade Angle	Length (in.)
MA282R	SEMI-SHARP	CVD	6 $\frac{1}{2}$
MA283R	W/ ROSEN POINT, SEMI-SHARP	CVD	6 $\frac{1}{2}$

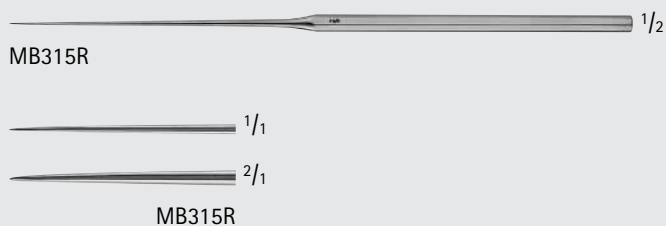

HOUSE-BARBARA Needle

Catalog Number	Tip	Blade Angle	Length (in.)
MB315R	SHARP	STR	6 $\frac{1}{2}$

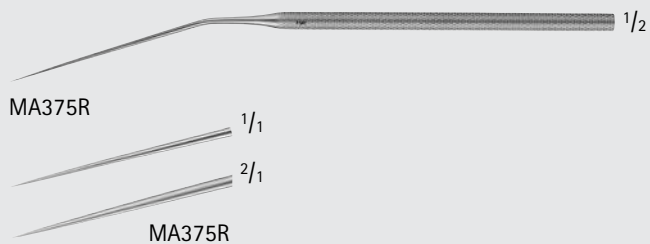

MCGEE Perforating Needle

Catalog Number	Tip	Blade Angle	Length (in.)
MA375R	SHARP	ANG 20°	6 $\frac{3}{8}$

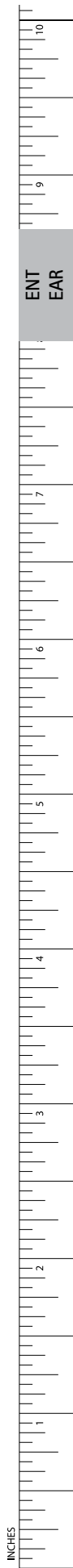

INCHES

ENT-EAR

Needles

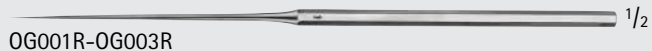

OG001R



OG002R

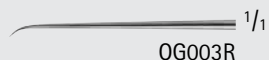

OG003R

Micro Needles

Catalog Number	Tip	Blade Angle	Length (in.)
OG001R	SHARP-POINT	STR	6 1/4
OG002R	SHARP-POINT	CVD	6 1/4
OG003R	SHARP-POINT	HEAVY-CVD	6 1/4



MA376R



PAPARELLA Needle, Malleable, Heavy

Catalog Number	Tip Size (#)	Blade Angle	Working Length (in.)	Length (in.)
MA376R	6	STR	2 3/4	6 1/2

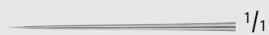
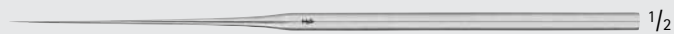

MA377R



SAUNDERS-PAPARELLA Needle, Malleable, Fine

Catalog Number	Tip Size (#)	Blade Angle	Working Length (in.)	Length (in.)
MA377R	5	STR	2 3/4	6 1/2



MA378R



WRIGHT Fascia Needle

Catalog Number	Tip	Tip Size (mm)	Length (in.)
MA378R	CVD	2	5 1/8





MA550R



MA550R

SHEEHY Ossicle Holding Forceps

Catalog Number	Length (in.)
MA550R	4 3/4

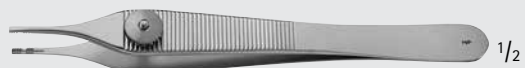

MA703R



MA703R

DERLACKI Ossicle Holding Forceps

Catalog Number	Tip	Length (in.)
MA703R	1 MM TEETH W/ VERTICAL AND HORIZONTAL GROOVE	5

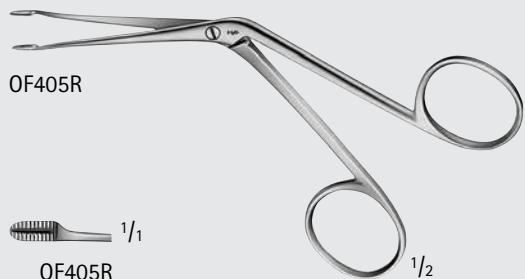

OF405R



OF405R



OF403R



OF403R

HARTMANN Tampon Forceps

Catalog Number	Tip	Length (in.)
OF405R	HEAVY	5
OF403R	DELICATE	5 1/4

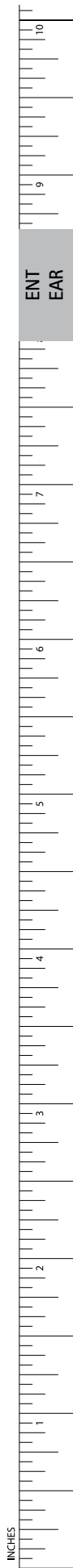

INCHES

ENT-EAR

Tissue/Dressing/Sponge Forceps

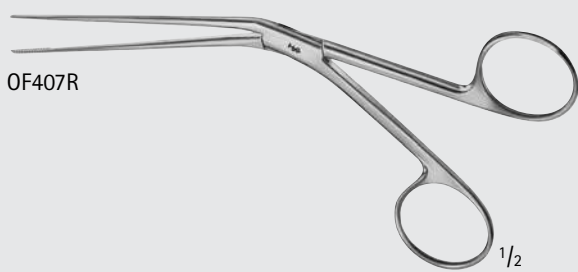

TILLEY Ear Tampon Forceps

Catalog Number	Tip	Length (in.)
OF407R	X-DEL	5 1/2

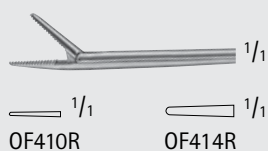
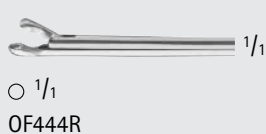
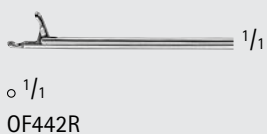
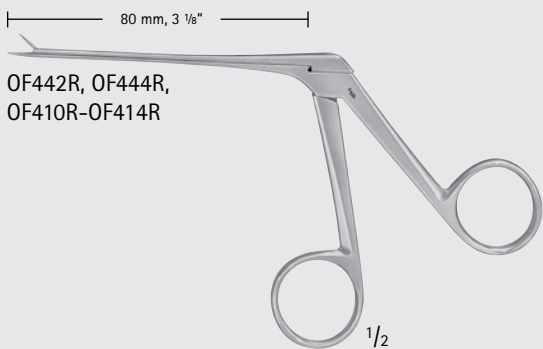

HARTMANN-WULLSTEIN Ear Forceps

Catalog Number	Tip Size (mm)	Jaw	Working Length (in.)
OF442R	1	STR, CUP	3 1/8
OF444R	2	STR, CUP	3 1/8
OF410R	0.5 x 6	STR, SERR	3 1/8
OF414R	1 x 8	STR, SERR	3 1/8

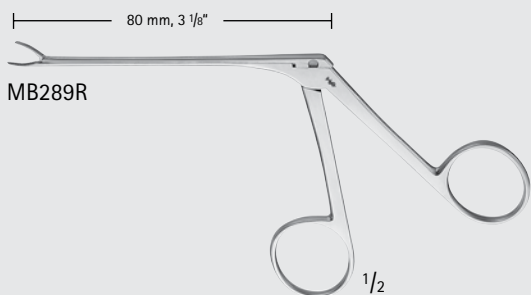

WEINGARTNER Ear Forceps

Catalog Number	Jaw	Working Length (in.)
MB289R	SERR	3 1/8

ENT
EAR

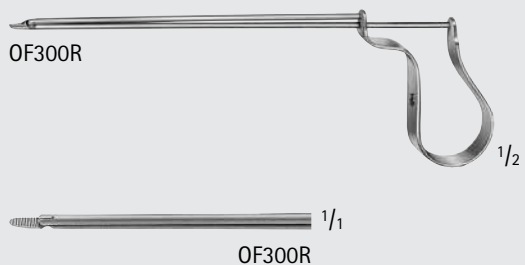
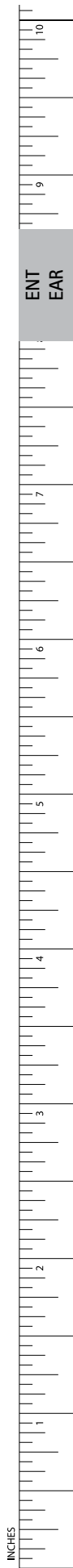

QUIRE Foreign Body Forceps

Catalog Number	Working Length (in.)	Length (in.)
OF300R	3 1/2	4 3/4

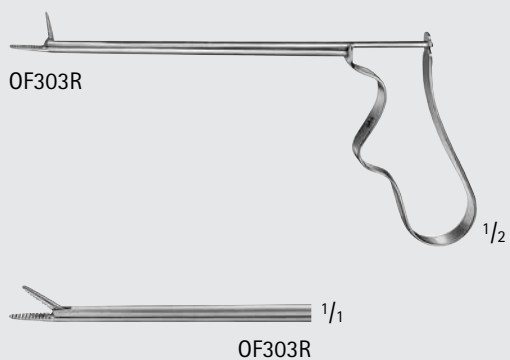

BUCK Alligator Forceps

Catalog Number	Working Length (in.)	Length (in.)
OF303R	1 7/8	3 1/2

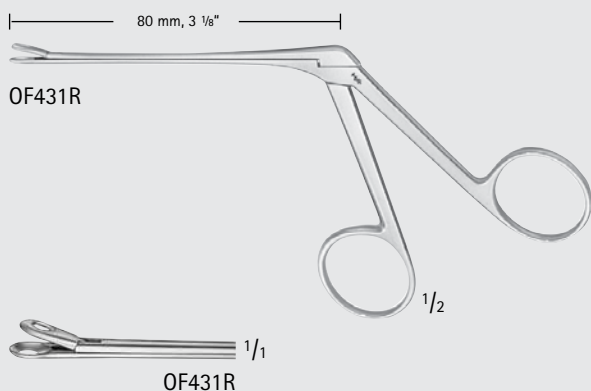

HENCKEL Spoon Forceps

Catalog Number	Tip Size (mm)	Jaw	Working Length (in.)
OF431R	3 x 5	FLAT, OVAL SPOON	3 1/8

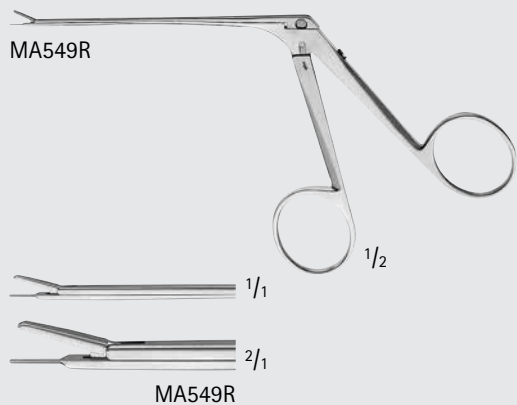

LEIVERS Vent Tube Introducer Forceps

Catalog Number	Working Length (in.)	Length (in.)
MA549R	2 7/8	5 3/8

ENT-EAR

Tissue/Dressing/Sponge Forceps

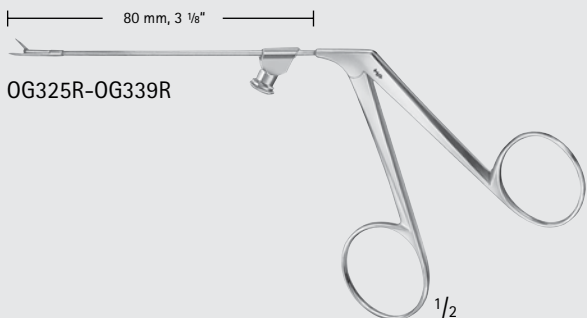
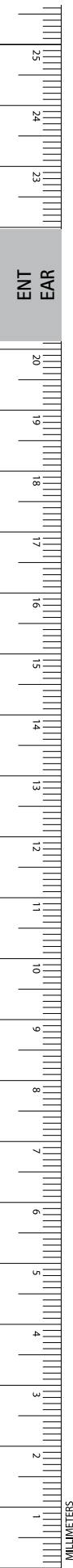

OG325R-OG339R

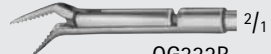

OG330R

OG338R

OG332R

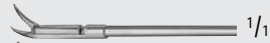
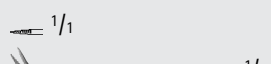
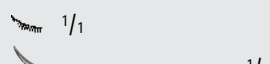

OG335R

OG339R

OG331R



OG325R

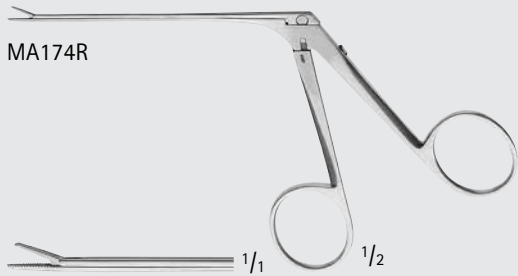

MA174R



MA174R

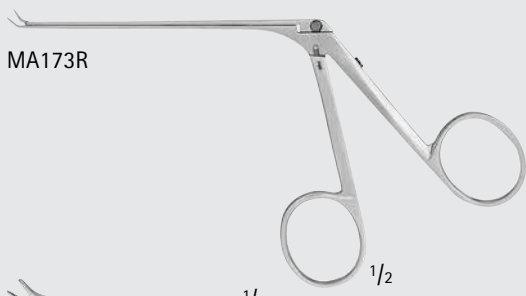

MA173R

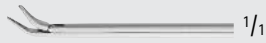

MA173R

Alligator Forceps, Serrated

Catalog Number	Tip Size (mm)	Jaw	Working Length (in.)
OG330R	0.8 x 3.5	STR	3 1/8
OG335R	1 x 5	STR	3 1/8
OG325R	1.5 x 6.0	STR	3 1/8
MA174R	4	STR	3 1/8
OG338R	1 x 5	CVD-LEFT	3 1/8
OG339R	1 x 5	CVD-RIGHT	3 1/8
OG332R	0.8 x 3.5	ANG-DOWN 45°	3 1/8
OG331R	0.8 x 3.5	ANG-UP 55°	3 1/8
MA173R	4	ANG-UP	3

ENT-EAR

Alligator Forceps

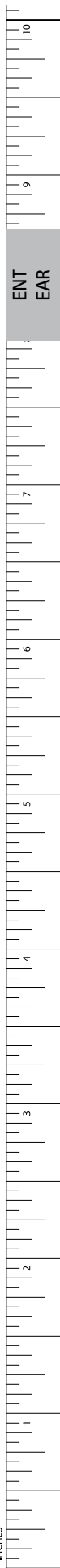

MA159R

1/2

1/1
2/1

MA159R

BELLUCCI Alligator Ear Forceps

Catalog Number	Tip Size (mm)	Jaw	Working Length (in.)
MA159R	8	STR, SERR	3 1/4

MA659R

1/2

1/1
2/1

MA659R

Alligator Ear Forceps, Ebony

Catalog Number	Tip Size (mm)	Jaw	Working Length (in.)
MA659R	0.8 x 4.5	STR, SERR	3

OF411R, OF420R

80 mm, 3 1/8"

1/2

1/1 OF411R
1/1 OF420R

HARTMANN Ear Forceps

Catalog Number	Tip Size (mm)	Jaw	Working Length (in.)
OF411R	1 x 8	STR, SERR	3 1/8
OF420R	1 x 8	STR, 1 x 2 TEETH	3 1/8

ENT-EAR

Alligator Forceps

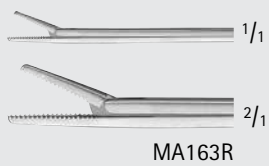
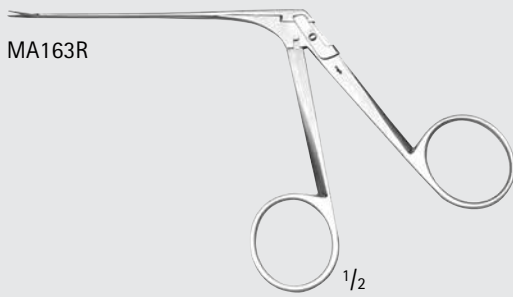

HOUSE Alligator Ear Forceps, Horizontal Opening

Catalog Number	Tip Size (mm)	Jaw	Working Length (in.)
MA163R	6	SERR	3 1/8

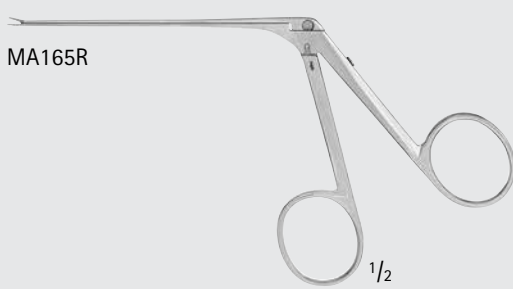

HOUSE Miniature Alligator Ear Forceps, Delicate

Catalog Number	Tip Size (mm)	Jaw	Working Length (in.)
MA165R	4	SERR	3 1/8

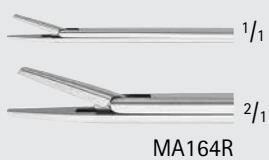
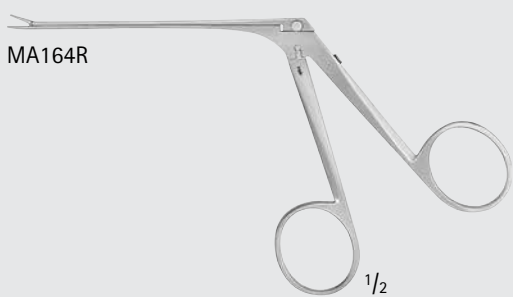

HOUSE Strut Forceps

Catalog Number	Tip Size (mm)	Jaw	Working Length (in.)
MA164R	6	STR, SMOOTH	3 1/8

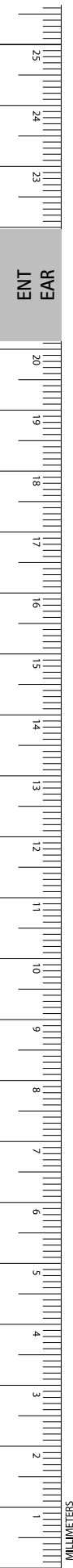

NOYES Ear Forceps

Catalog Number	Tip Size (mm)	Jaw	Working Length (in.)
MA168R	6	SERR	3
MA169R	7	SERR, 1 x 2 TEETH	3

MA168R-MA169R



1/2



1/1



2/1

MA168R



1/1



2/1

MA169R

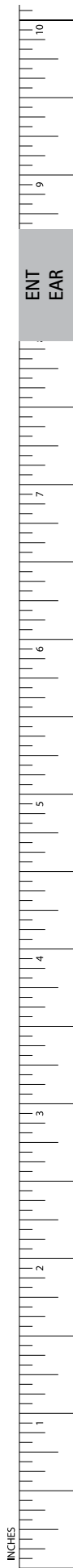

INCHES

ENT-EAR

Alligator Cup and Punch Forceps

MA248R-MA249R

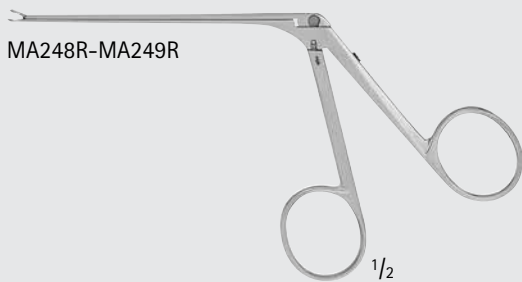

1/2



MA248R



MA249R

Cup Forceps

Catalog Number	Jaw	Cup Size (mm)	Working Length (in.)
MA249R	FINE	0.7 x 1.0	2 3/4
MA248R	EXTRA FINE	0.9 x 2.0	2 3/4

MA240R-MA241R



3 1/8



MA240R



MA241R

MA242R

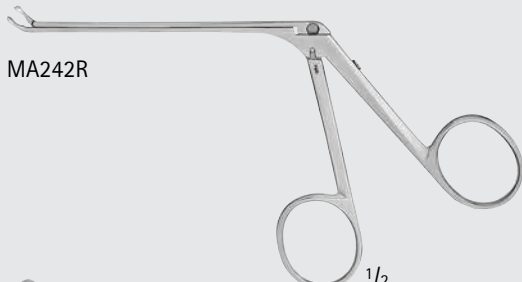

3 1/8



MA242R

HARTMANN-HERZFELD Cup Forceps

Catalog Number	Jaw	Cup Size (mm)	Working Length (in.)
MA240R	STR	1.5	3 1/8
MA241R	STR	3.0	3 1/8
MA242R	UPBITE	2.0	3 1/8

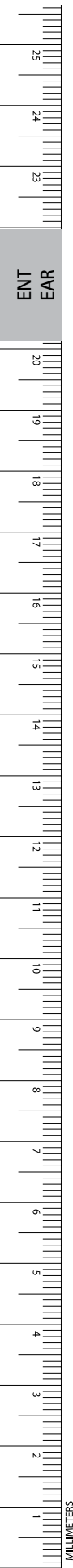

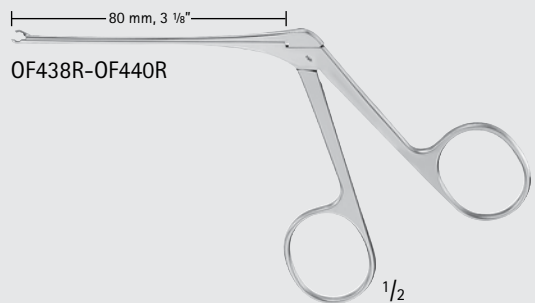

HARTMANN Cup Forceps

Catalog Number	Cup Size (mm)	Jaw	Working Length (in.)
OF438R	2.0	STR	3 1/8
OF439R	2.5	STR	3 1/8
OF440R	3.0	STR	3 1/8

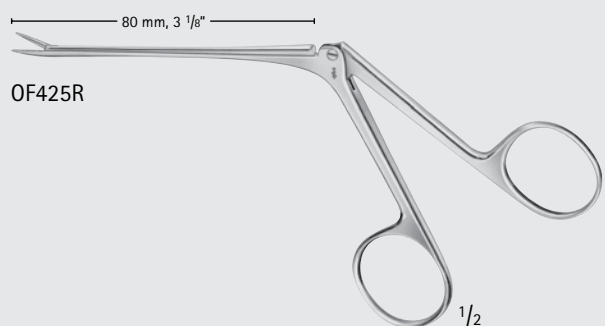
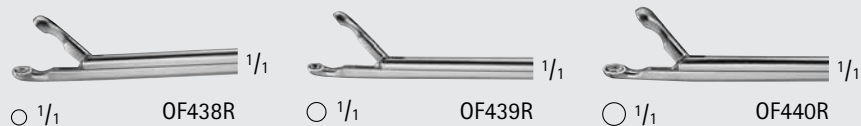

HARTMANN Forceps, Oval

Catalog Number	Cup Size (mm)	Jaw	Working Length (in.)
OF425R	2 x 7	STR	3 1/8

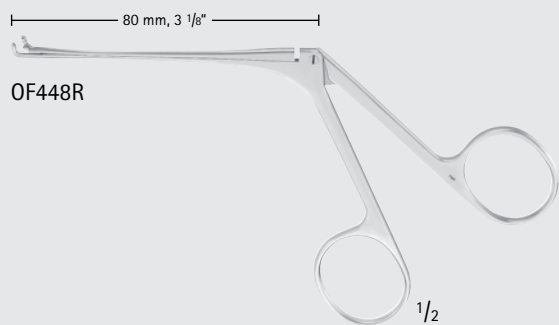
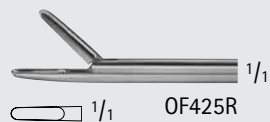

HARTMANN-CITELLI Cup Forceps

Catalog Number	Cup Size (mm)	Jaw	Working Length (in.)
OF448R	2.0	UPBITE	3 1/8



ENT-EAR

Alligator Cup and Punch Forceps

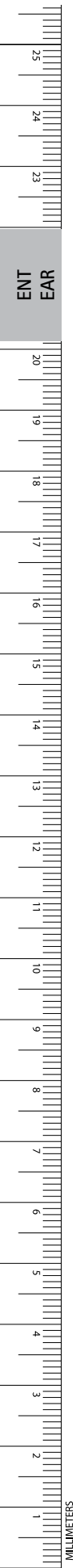

MA243R

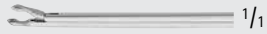
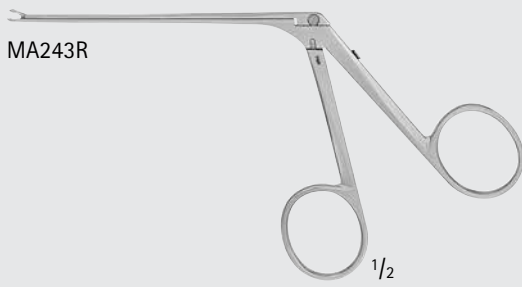

MA243R

MA244R-MA245R

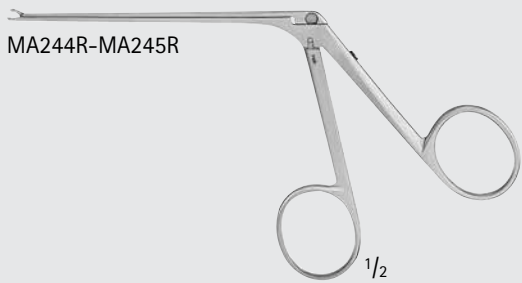

MA244R



MA245R

HOUSE Cup Forceps, Miniature

Catalog Number	Cup Size (mm)	Jaw	Working Length (in.)
MA243R	0.6 x 1.0	STR	3 1/8
MA244R	0.6 x 1.0	ANG 15° LEFT	5 1/8
MA245R	0.6 x 1.0	ANG 15° RIGHT	5 1/8

MA246R-MA247R

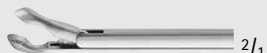

MA246R



MA247R

HOUSE Oval Cup Forceps

Catalog Number	Cup Size (mm)	Jaw	Working Length (in.)
MA247R	0.9	ANG 15° LEFT	2 3/4
MA246R	0.9	ANG 15° RIGHT	2 3/4

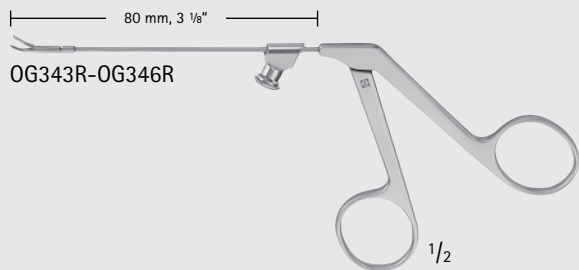

WULLSTEIN Micro Cup Forceps

Catalog Number	Cup Size (mm)	Jaw	Working Length (in.)
OG345R	0.8 x 1.3	STR	3 1/8
OG348R	1.7 x 2.5	STR	3 1/8
OG343R	0.8 x 1.3	CVD-LEFT	3 1/8
OG344R	0.8 x 1.3	CVD-RIGHT	3 1/8
OG346R	1.0	STR, ROUND	3 1/8

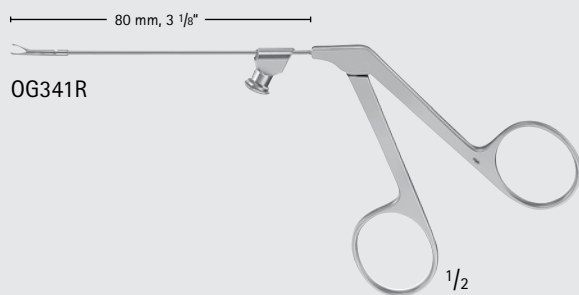
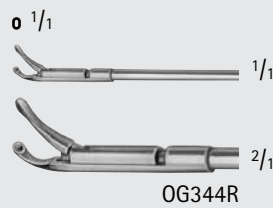
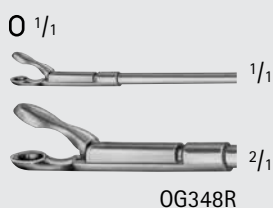
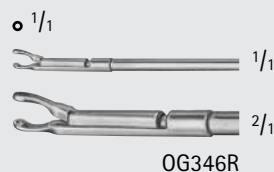
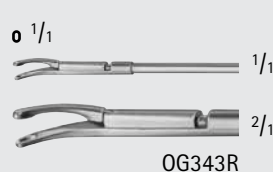
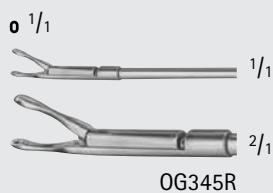

Micro Cup Forceps

Catalog Number	Cup Size (mm)	Jaw	Working Length (in.)
OG341R	0.9 x 1	STR	3 1/8
OG342R	0.9 x 1	CVD, UP	3 1/8

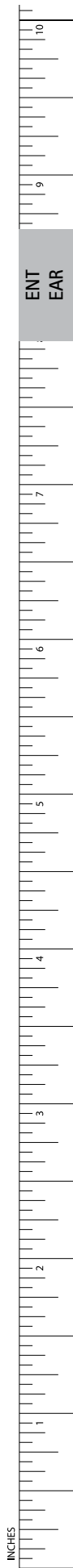
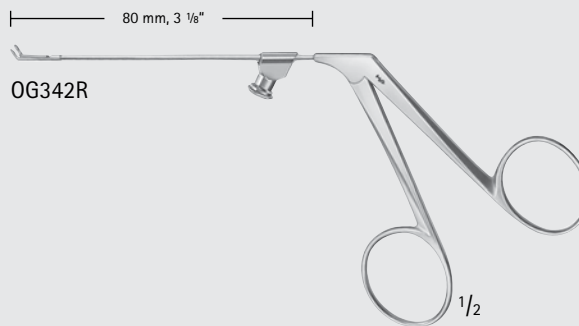

INCHES

ENT-EAR

Nippers/Crimping Forceps/Wire Guides/Cutters/Snares

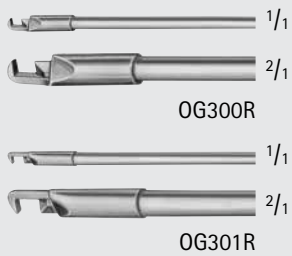
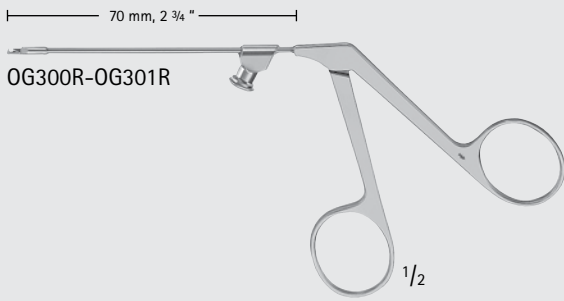

DIETER Malleus Nipper

Catalog Number	Tip	Working Length (in.)
OG300R	UP BITE	2 3/4
OG301R	DOWN BITE	2 3/4

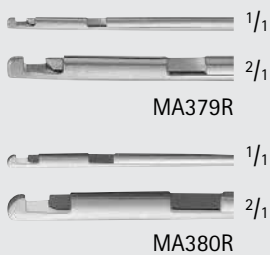

HOUSE-DIETER Malleus Nipper

Catalog Number	Jaw Length (mm)	Working Length (in.)
MA379R	1.5	3 1/8
MA380R	2.0	3 1/8

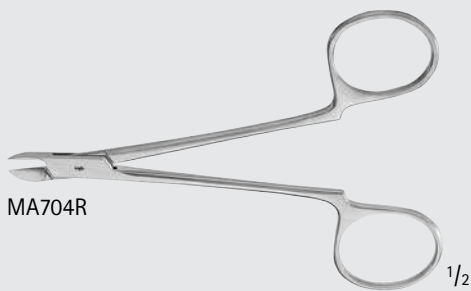

LEMPERT Malleus Cutter

Catalog Number	Jaw Length (mm)	Length (in.)
MA704R	11	4 1/2

ENT
EAR

1
2
3
4
5
6
7
8
9
10
11
12
13
14
15
16
17
18
19
20
23
24
25
MILLIMETERS

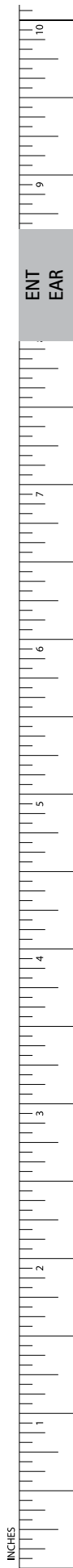

HOUSE Alligator Crimper

Catalog Number	Jaw Length (mm)	Tip	Working Length (in.)	Length (in.)
MA028R	8	SERR	2 7/8	5 1/8

MA028R

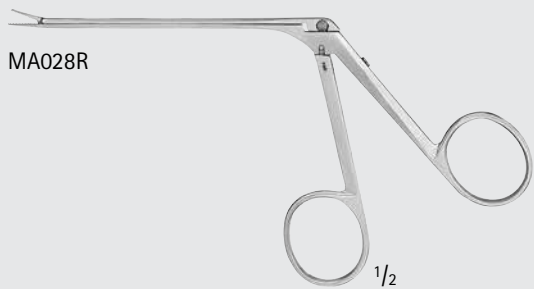

MA028R

SCHEER Wire Crimper

Catalog Number	Jaw Length (mm)	Tip	Working Length (in.)	Length (in.)
MA660R	7	SMOOTH	3 1/4	5 1/8

MA660R

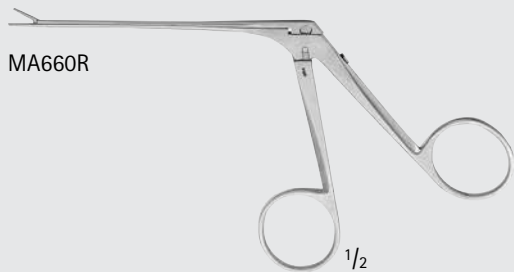

MA660R

SCHUKNECHT Wire Crimper

Catalog Number	Jaw Length (mm)	Working Length (in.)	Length (in.)
MA662R	3	3 1/8	5 1/8

MA662R



MA662R

ENT-EAR

Nippers/Crimping Forceps/Wire Guides/Cutters/Snares

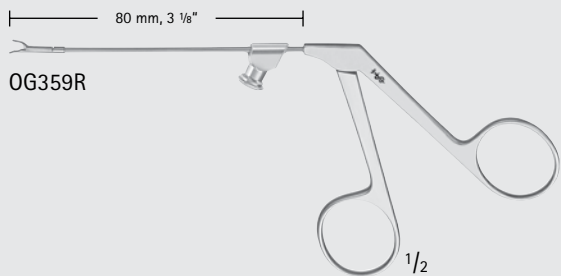

OG359R



OG359R

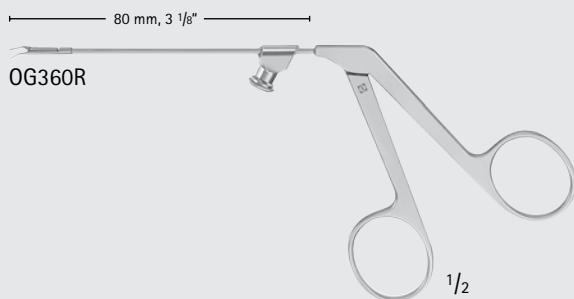

OG360R



OG360R

MCGEE Wire Crimper

Catalog Number	Tip Size (mm)	Blade	Working Length (in.)
OG359R	3.5	CVD-DOWN	3 1/8
OG360R	5	CVD-DOWN	3 1/8



MA456R

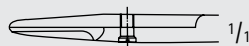

MA456R

GUILFORD-WRIGHT Wire Cutter

Catalog Number	Jaw	Length (in.)
MA456R	SERR	3 3/8

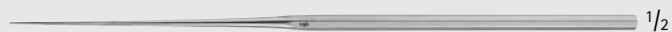

MA298R

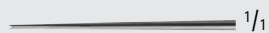

MA298R

HOUSE Strut Guide

Catalog Number	Tip Size (mm)	Tip	Length (in.)
MA298R	0.6	ANG	6 1/2

ENT
EAR

MILLIMETERS

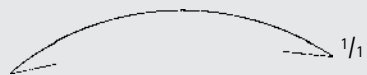

OF528R

Ear Snare Wire, Pkg/100

Catalog Number	Diameter (mm)
OF528R	0.2



OF505R

KRAUSE Ear Snare, Extra Delicate

Catalog Number	Length (in.)
OF505R	6 1/4

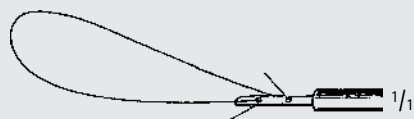

OF505R

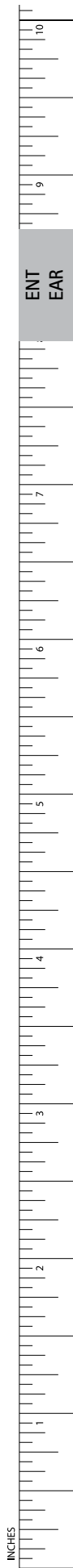

ENT-EAR

Hooks and Probes

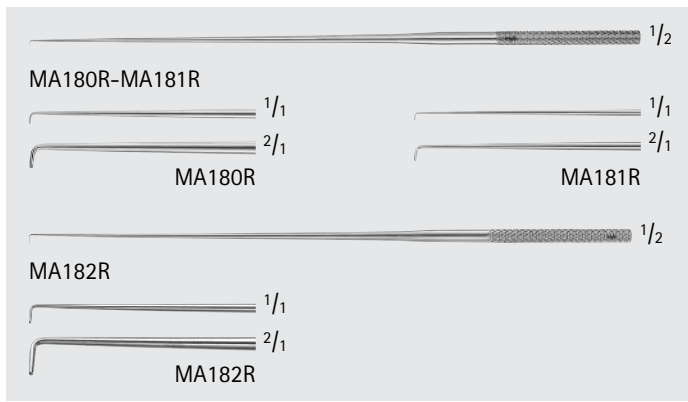
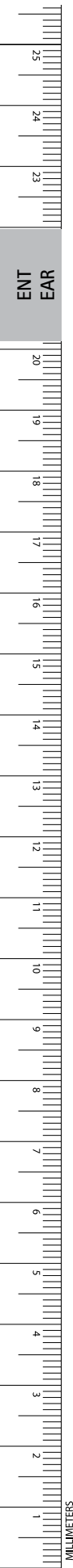

DAY Ear Hook

Catalog Number	Size	Tip Size (mm)	Tip	Length (in.)
MA180R	X-SMALL	1.5	ANG 90°	6 1/4
MA181R	SMALL	2.0	ANG 90°	6 1/4
MA182R	LARGE	2.5	ANG 90°	6 1/4

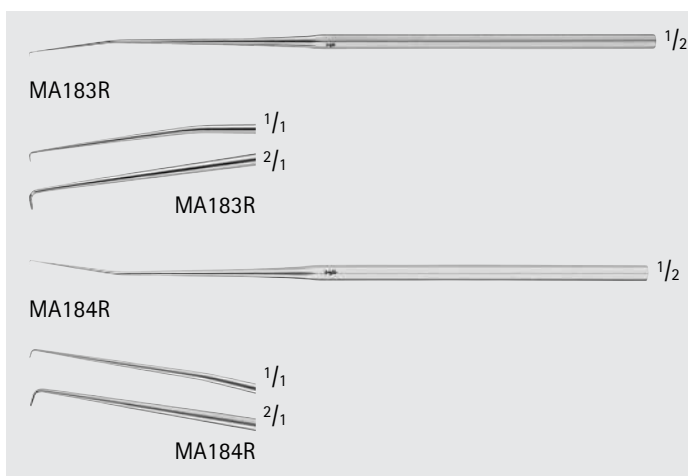

HOUSE Hook Ear Hook

Catalog Number	Tip Size (mm)	Tip	Length (in.)
MA183R	1	ANG 90° LEFT	6 5/8
MA184R	1	ANG 90° RIGHT	6 5/8

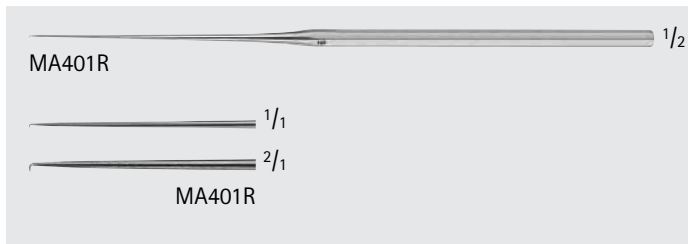

SAUNDERS-PAPARELLA Stapes Hook

Catalog Number	Tip Size (mm)	Tip	Tip Size (#)	Length (in.)
MA401R	0.5	ANG 90°, MALLEABLE	9	6 1/2

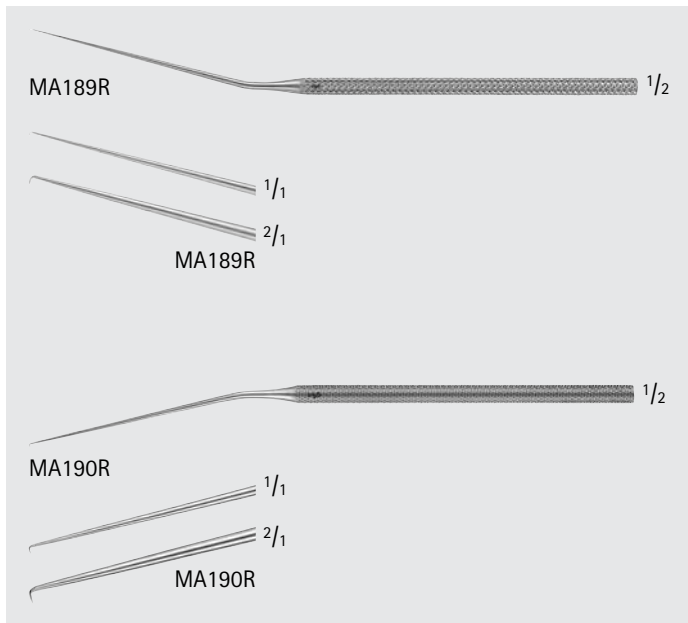

SCHUKNECHT Hook

Catalog Number	Tip Size (mm)	Tip	Length (in.)
MA189R	0.4	ANG-UP, ANTERIOR	6 1/4
MA190R	0.6	ANG-DOWN, POSTERIOR	6 1/4

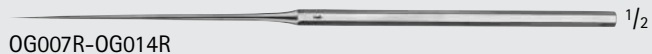

OG007R-OG014R

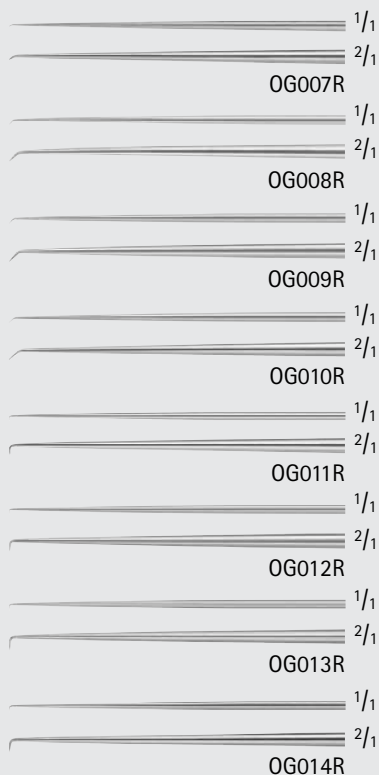

SHAMBAUGH Fen Hook

Catalog Number	Tip Size (mm)	Angle	Length (in.)
OG007R	0.4	45°	6 1/4
OG008R	0.6	45°	6 1/4
OG009R	0.8	45°	6 1/4
OG010R	1.0	45°	6 1/4
OG011R	0.4	90°	6 1/4
OG012R	0.6	90°	6 1/4
OG013R	0.8	90°	6 1/4
OG014R	1.0	90°	6 1/4



OF277R-OF279R

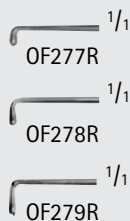

LUCAE Ear Hook Button

Catalog Number	Size	Length (in.)
OF277R	SMALL	5 1/2
OF278R	MEDIUM	5 1/2
OF279R	LARGE	5 1/2



OF282R-OF285R

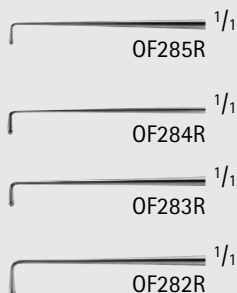

WAGENER Nerve Hook Button

Catalog Number	Size	Length (in.)
OF285R	X-SMALL	6
OF284R	SMALL	6
OF283R	MEDIUM	6
OF282R	LARGE	6



INCHES

ENT-EAR

Retractors

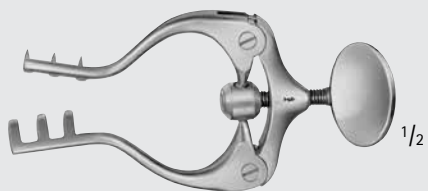

BV030R



BV030R



BV032R



BV032R



BV033R

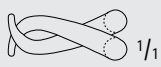

BV033R

JANSEN Retractor

Catalog Number	Tip	Blade End	Length (in.)
BV030R	SHARP	3 x 3 PRONGS	4
BV032R	BLUNT	3 x 3 PRONGS	4
BV033R	BLUNT	3 x 4 PRONGS	4

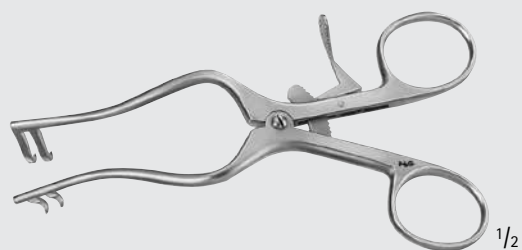

BV078R

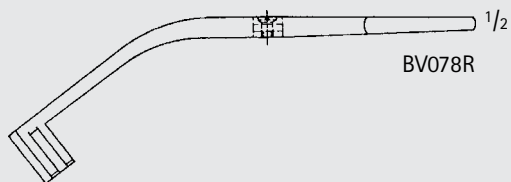

BV078R



1/1

PLESTER-PAPARELLA-WEITLANER Retractor

Catalog Number	Tip	Blade End	Length (in.)
BV078R	SHARP	2 x 2 PRONGS	5 1/8

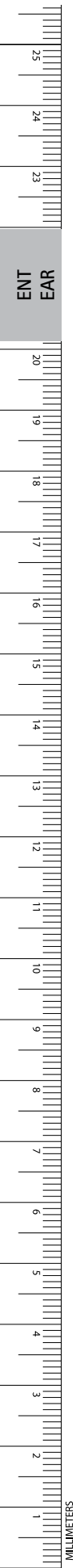

SCHUKNECHT Retractor

Catalog Number	Tip	Blade End	Length (in.)
MA433R	ANG, SHARP	3 x 3 PRONGS	5 1/8

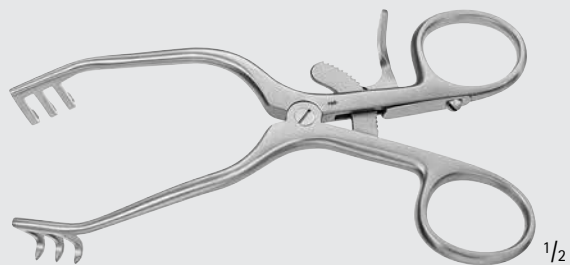

MA433R

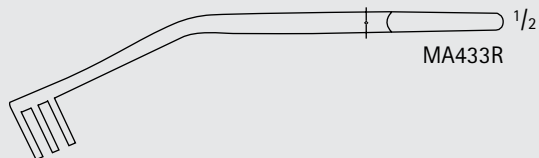

MA433R

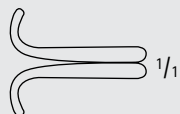

1/1

HOUSE Hand Retractor, Double Ended

Catalog Number	Blade Size (mm)	Length (in.)
MA432R	20 x 7 / 25 x 9	6

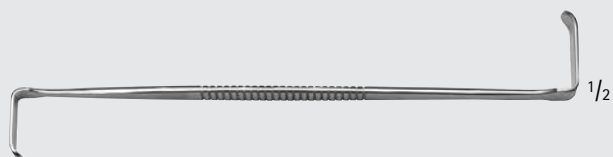

MA432R

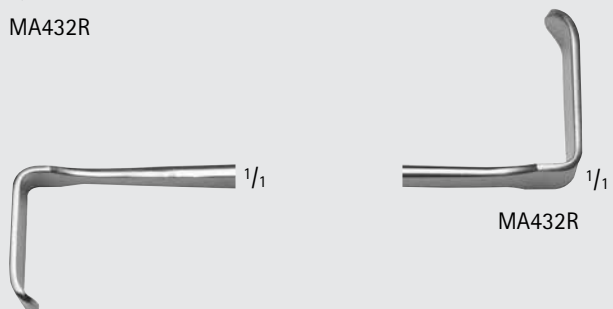

1/1

MA432R

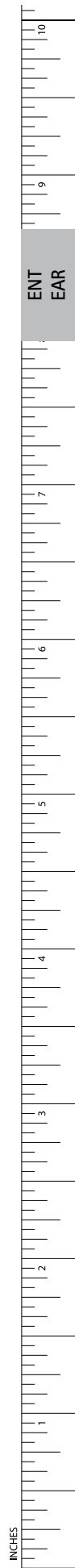

INCHES

ENT-EAR

Picks

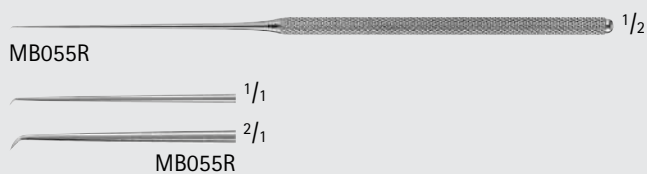

AUSTIN Pick

Catalog Number	Tip Size (mm)	Tip	Length (in.)
MB055R	1.0	ANG 45°	6 1/4

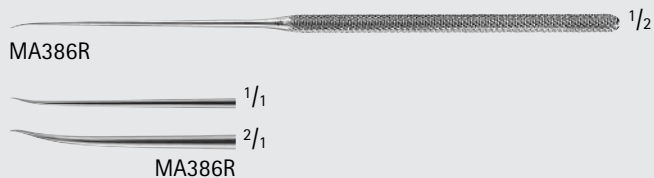

BELLUCCI Pick

Catalog Number	Tip	Tip Size (mm)	Length (in.)
MA386R	CVD POINT, 4 MM FROM TIP	-	6 5/8
MA388R	ANG 90°	0.5	6 5/8

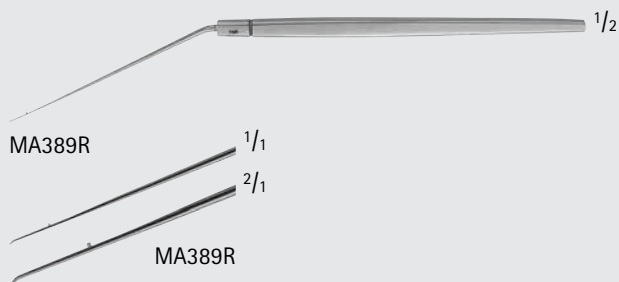
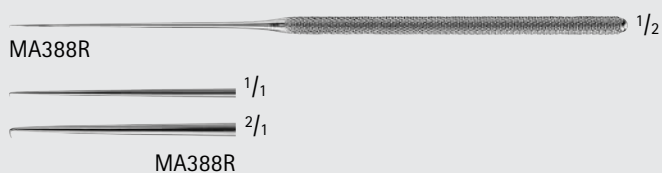

FARRIOR Footplate Pick, with Notch

Catalog Number	Tip	Shaft	Length (in.)
MA389R	ANTERIOR, CVD-RIGHT	ANG	5 7/8
MA390R	POSTERIOR, CVD-LEFT	ANG	5 7/8

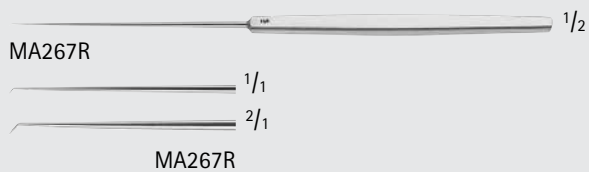
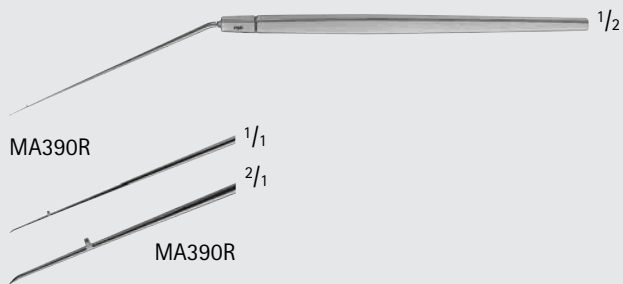

GUILFORD-WRIGHT Footplate

Catalog Number	Tip Size (mm)	Tip	Length (in.)
MA267R	0.5	ANG 45°	5 1/2

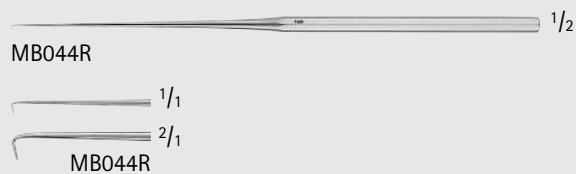

GUILFORD-WRIGHT Stapes Pick, Heavy

Catalog Number	Tip	Length (in.)
MB044R	ANG 90°	5 1/2



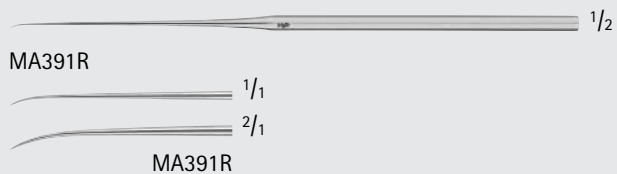
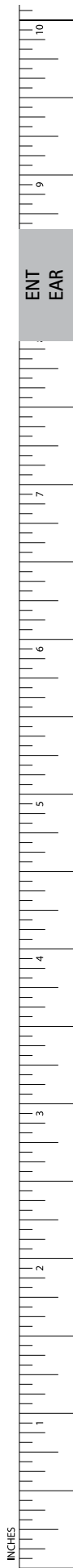

HOUGH Footplate Pick

Catalog Number	Tip	Length (in.)
MA391R	CVD	5 7/8

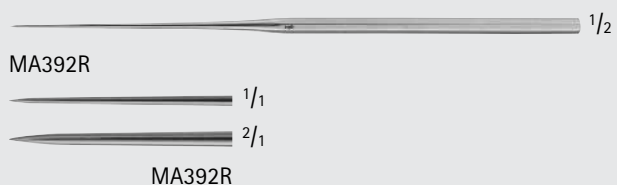

HOUGH Pick

Catalog Number	Tip	Length (in.)
MA392R	STR	5 7/8

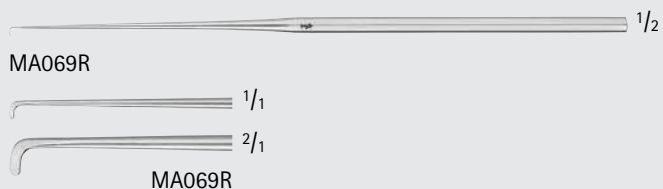

HOUSE-CRABTREE Dissector Pick

Catalog Number	Tip Size (mm)	Tip	Length (in.)
MA069R	2.5	ANG 90°	6 5/8

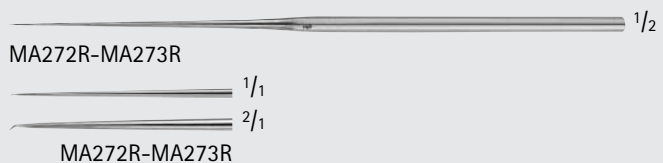

HOUSE Oval Window Pick

Catalog Number	Tip Size (mm)	Tip	Shaft	Length (in.)
MA272R	0.33	ANG 30°	-	6 1/2
MA273R	0.66	ANG 30°	-	6 1/2
MA284R	0.33	ANG 90°	FINE	6 1/2
MA393R	0.33	ANG 90°	MEDIUM	6 5/8

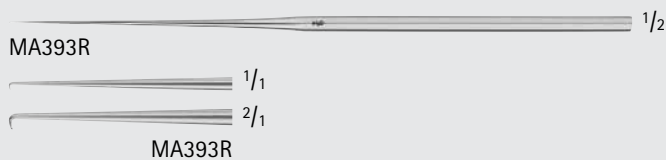
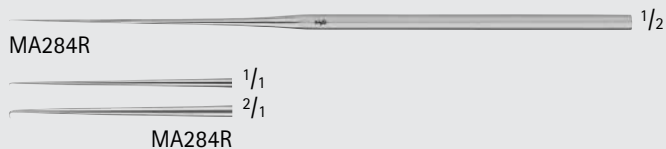

ENT-EAR

Picks

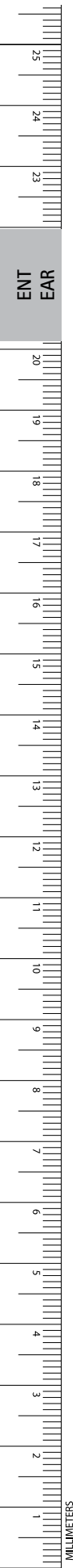

MA396R-MA397R $\frac{1}{2}$

$\frac{1}{1}$

$\frac{2}{1}$

MA397R

$\frac{1}{1}$

$\frac{2}{1}$

MA396R

MA395R $\frac{1}{2}$

$\frac{1}{1}$

$\frac{2}{1}$

MA395R

MA394R $\frac{1}{2}$

$\frac{1}{1}$

$\frac{2}{1}$

MA394R

MA406R $\frac{1}{2}$

$\frac{1}{1}$

$\frac{2}{1}$

MA406R

MA405R $\frac{1}{2}$

$\frac{1}{1}$

$\frac{2}{1}$

MA405R

HOUSE Strut Pick

Catalog Number	Tip Size (mm)	Tip	Length (in.)
MA397R	0.5	ANG 90°	6 1/2
MA396R	0.66	ANG 90°	6 1/2
MA395R	0.75	ANG 90°	6 1/2
MA394R	1.0	ANG 90°	6 1/2
MA406R	1.5	ANG 90°	6 1/2
MA405R	3.0	ANG 90°	6 1/2

MA251R $\frac{1}{2}$

$\frac{1}{1}$

$\frac{2}{1}$

MA251R

HOUSE-BARBARA Pick, Malleable

Catalog Number	Tip	Length (in.)
MA251R	STR	6 1/2

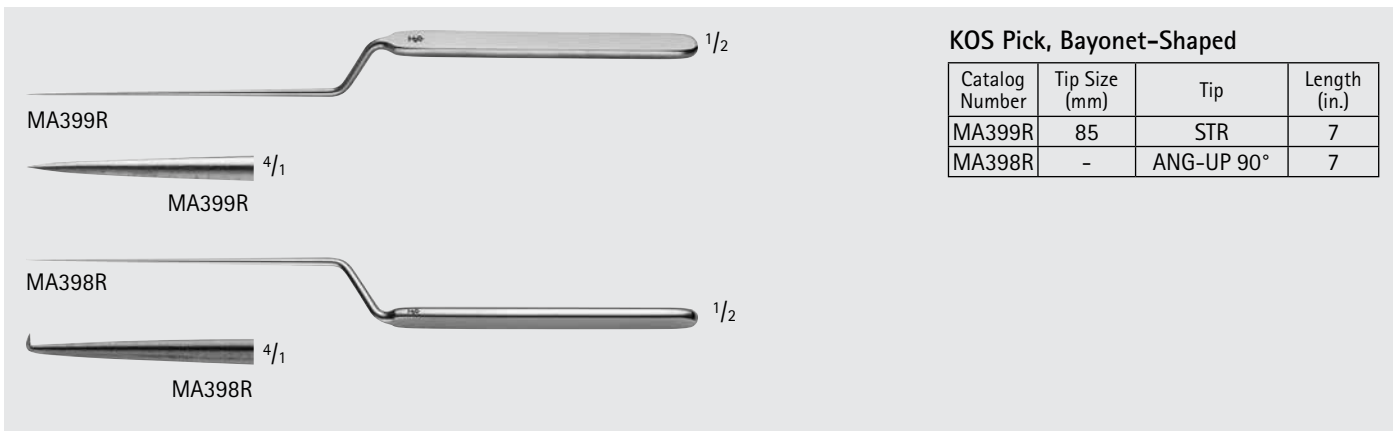

KOS Pick, Bayonet-Shaped

Catalog Number	Tip Size (mm)	Tip	Length (in.)
MA399R	85	STR	7
MA398R	-	ANG-UP 90°	7

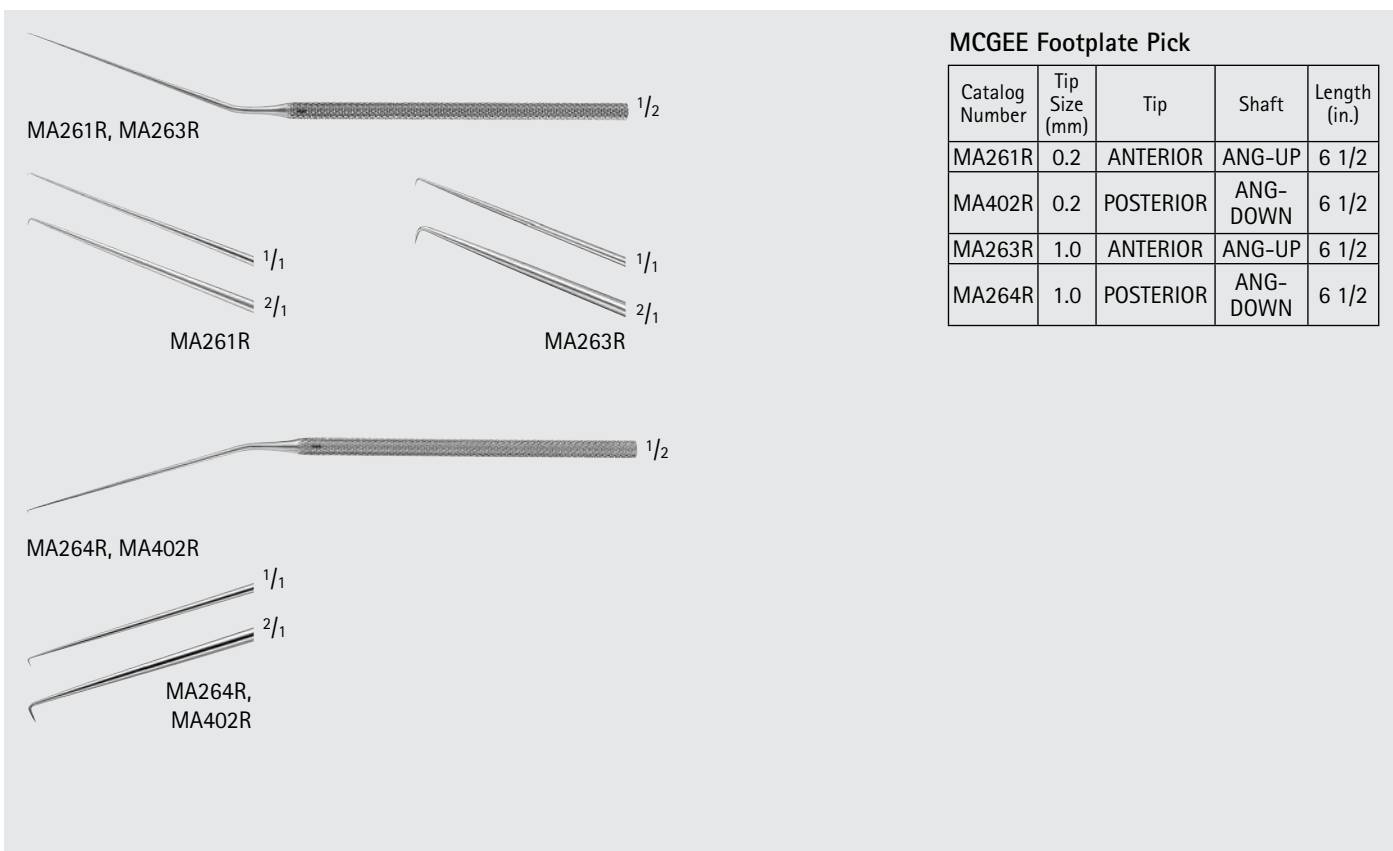

MCGEE Footplate Pick

Catalog Number	Tip Size (mm)	Tip	Shaft	Length (in.)
MA261R	0.2	ANTERIOR	ANG-UP	6 1/2
MA402R	0.2	POSTERIOR	ANG-DOWN	6 1/2
MA263R	1.0	ANTERIOR	ANG-UP	6 1/2
MA264R	1.0	POSTERIOR	ANG-DOWN	6 1/2

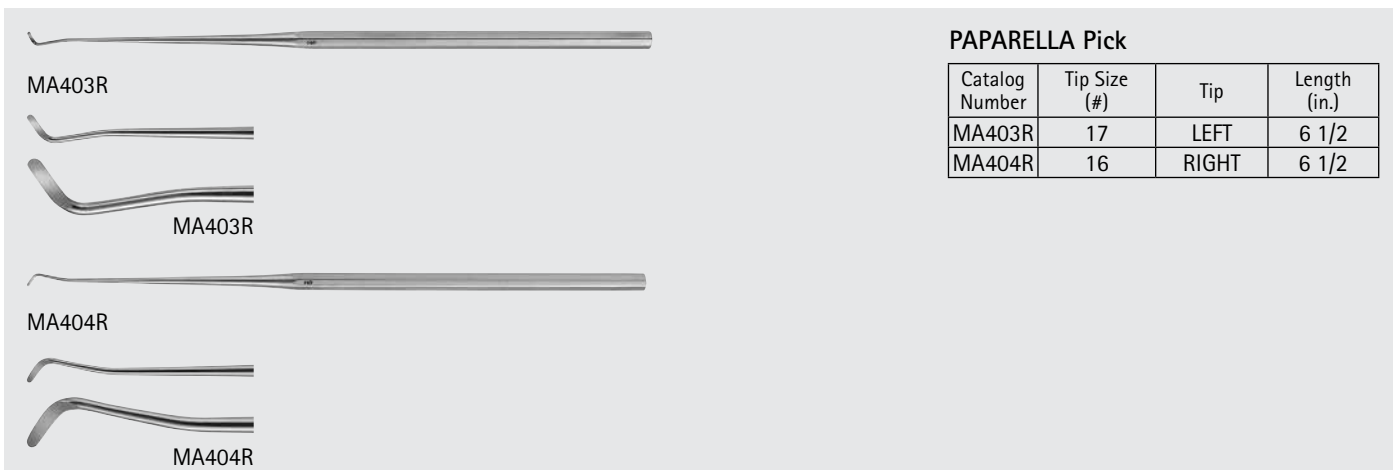

PAPARELLA Pick

Catalog Number	Tip Size (#)	Tip	Length (in.)
MA403R	17	LEFT	6 1/2
MA404R	16	RIGHT	6 1/2

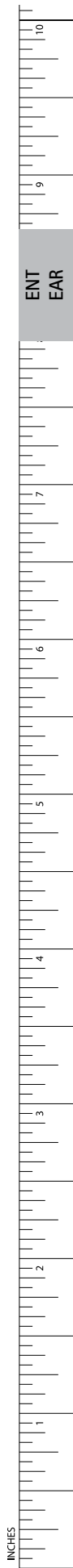

ENT-EAR

Specula and Holders

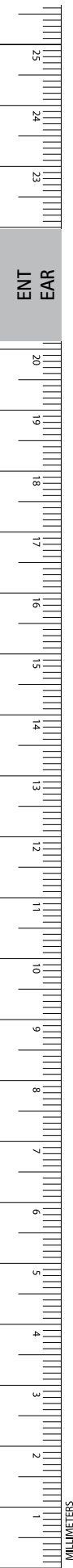

US101-US103



US101



US102



US103

Ear Speculum, Oval, Ebony

Catalog Number	Tip Size (mm)
US101	4.5 x 5.5
US102	5.5 x 6.5
US103	6.5 x 7.5



OF102C-OF104C



OF102C



OF103C



OF104C

POLITZER Ear Speculum, Round, Pediatric

Catalog Number	Tip Size (mm)
OF101C	SET OF 3 OF102C-OF104C
OF102C	2
OF103C	3
OF104C	4



OF121C-OF124C



OF121C



OF122C



OF123C



OF124C

BOUCHERON Ear Speculum, Round, Adult

Catalog Number	Tip Size (mm)
OF120C	SET OF 4 OF121C-OF124C
OF121C	4.2
OF122C	5.2
OF123C	6.2
OF124C	7.2

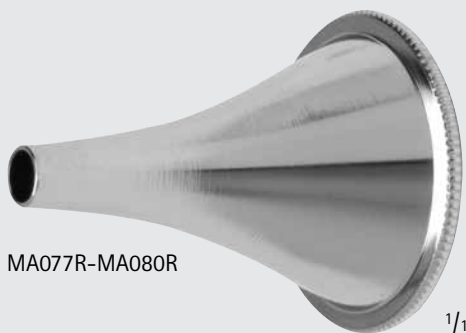

MA077R-MA080R



MA077R



MA078R



MA079R



MA080R

BOUCHERON Ear Speculum, Round, Large

Catalog Number	Tip Size (mm)
MA076R	SET OF 4 MA077R-MA080R
MA077R	5.5
MA078R	6.6
MA079R	7.5
MA080R	9.0



MA072R-MA075R

1/1



MA072R



MA073R



MA074R

BOUCHERON Ear Speculum, Round, Small

Catalog Number	Size (#)	Tip Size (mm)
MA071R	-	SET OF 4 MA072R-MA075R
MA072R	1	3.0
MA073R	2	4.0
MA074R	3	4.5
MA075R	4	5.0



MA075R



MA090R-MA096R,
MA648R-MA649R

1/1



MA648R



MA649R



MA090R



MA093R



MA094R



MA095R

FARRIOR Ear Speculum, Oval, Oblique

Catalog Number	Size (#)	Tip Size (mm)
MA648R	XX-SMALL	3 x 4
MA649R	X-SMALL	4 x 5
MA089R	-	SET OF 7 MA090R-MA096R
MA090R	1	5 x 6
MA091R	2	6 x 7
MA092R	3	7 x 8
MA093R	4	8 x 10
MA094R	5	9 x 11
MA095R	6	10 x 12
MA096R	7	11 x 13



MA091R



MA092R

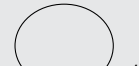

MA096R



MA097R-MA104R

1/1



MA098R



MA099R



MA100R



MA103R



MA104R

FARRIOR Ear Speculum, Round, Oblique

Catalog Number	Size (#)	Tip Size (mm)
MA097R	-	SET OF 7 MA098R-MA104R
MA098R	1	6
MA099R	2	7
MA100R	3	8
MA101R	4	9
MA102R	5	10
MA103R	6	11
MA104R	7	12



MA101R



MA102R



ENT
EAR

INCHES

ENT-EAR

Specula and Holders



MA082R-MA088R,
MA646R-MA647R

1/1



MA646R



MA647R



MA082R



MA083R



MA084R



MA085R



MA086R



MA087R



MA088R

FARRIOR Ear Speculum, Oval, Regular

Catalog Number	Size (#)	Tip Size (mm)
MA646R	XX-SMALL	3 x 4
MA647R	X-SMALL	4 x 5
MA081R	-	SET OF 7 MA082R-MA088R
MA082R	1	4.5 x 6
MA083R	2	5.5 x 7
MA084R	3	6.5 x 8
MA085R	4	7.5 x 9
MA086R	5	8 x 10
MA087R	6	9 x 11.25
MA088R	7	10 x 12.5



MA106R-MA112R

1/1



MA106R



MA107R



MA108R



MA109R



MA110R



MA111R



MA112R

FARRIOR Ear Speculum, Round, Regular

Catalog Number	Size (#)	Tip Size (mm)
MA105R	-	SET OF 7 MA106R-MA112R
MA106R	1	5.0
MA107R	2	6.0
MA108R	3	7.0
MA109R	4	8.0
MA110R	5	9.0
MA111R	6	10.0
MA112R	7	10.5

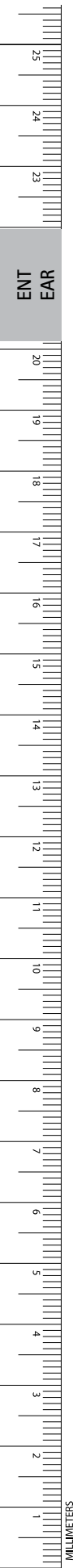



MB137R, MA650R-MA652R

GRUBER Ear Speculum, Oval, Infant

Catalog Number	Size (#)	Tip Size (mm)
MB242R	SMALL	2.0 x 2.5
MB243R	MEDIUM	2.5 x 3.0
MB244R	LARGE	3.0 x 4.0



MB242R



MB243R



MB244R



MA117R

GRUBER Ear Speculum, Oval, Infant, Long

Catalog Number	Tip Size (mm)
MA117R	4.5 x 5.0



MA117R



MA119R-MA121R

GRUBER Ear Speculum, Oval, Light

Catalog Number	Size (#)	Tip Size (mm)
MA118R	-	SET OF 3 MA119R-MA121R
MA119R	1	1.6 x 2.4
MA120R	2	2.4 x 3.2
MA121R	3	3.2 x 4.7



MA119R



MA120R



MA121R



MA114R-MA116R

GRUBER Ear Speculum, Oval, Heavy, Long

Catalog Number	Size (#)	Tip Size (mm)
MA114R	1	5 x 6
MA115R	2	6 x 7
MA116R	3	7 x 8



MA114R



MA115R



MA116R



ENT
EAR

INCHES

ENT-EAR

Specula and Holders



MA125R-MA127R



MA125R



MA126R



MA127R

GRUBER Ear Speculum, Round, Short, Light

Catalog Number	Size (#)	Tip Size (mm)
MA124R	-	SET OF 3 MA125R-MA127R
MA125R	1	3 x 33
MA126R	2	4 x 35
MA127R	3	5 x 37

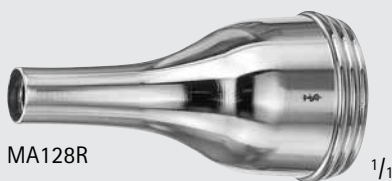

MA128R

GRUBER Ear Speculum, Round, Long, Heavy

Catalog Number	Description
MA128R	SET OF 3



MA130R-MA136R



MA130R



MA136R

HARTMANN Ear Speculum, Infant

Catalog Number	Tip	Tip Size (mm)
MA130R	ROUND	2.5
MA136R	OVAL	2.5 x 3



OF115C-OF117C



OF115C



OF116C



OF117C

HARTMANN Ear Speculum, Infant

Catalog Number	Tip Size (mm)
OF115C	1.8
OF116C	3.2
OF117C	4.6



MA132R-MA135R



MA132R



MA133R



MA134R



MA135R

HARTMANN Ear Speculum, Oval

Catalog Number	Size (#)	Tip Size (mm)
MA131R	-	SET OF 4 MA132R-MA135R
MA132R	1	4.5 x 5.5
MA133R	2	5.5 x 6
MA134R	3	6.5 x 7
MA135R	4	7.5 x 8

ENT
EAR

25
24
23
20
19
18
17
16
15
14
13
12
11
10
9
8
7
6
5
4
3
2
1
MILLIMETERS



MA129R, MA650R-MA652R



MA650R



MA651R



MA137R



MA652R

HARTMANN Ear Speculum, Round, Adult

Catalog Number	Size (#)	Tip Size (mm)
MA129R	-	SET OF 4 MA137R, MA650R-MA652R
MA650R	1	4
MA651R	2	5
MA137R	3	6
MA652R	4	7



OF111C-OF114C



OF111C



OF112C



OF113C



OF114C

HARTMANN Ear Speculum, Round

Catalog Number	Tip Size (mm)
OF111C	3.5
OF112C	5.0
OF113C	6.5
OF114C	8.0



MA606R

SHEA Speculum Holder

Catalog Number	Length (in.)
MA606R	11 3/4



ENT
EAR

INCHES

ENT-EAR

Applicators and Searchers



LATHBURY-FARRELL Cotton Applicator, Triangular Serrated

Catalog Number	Tip Size (mm)	Length (in.)
BN467R	0.9	5 1/2
BN465R	1.4	5 1/2
BN466R	1.2	6 1/4

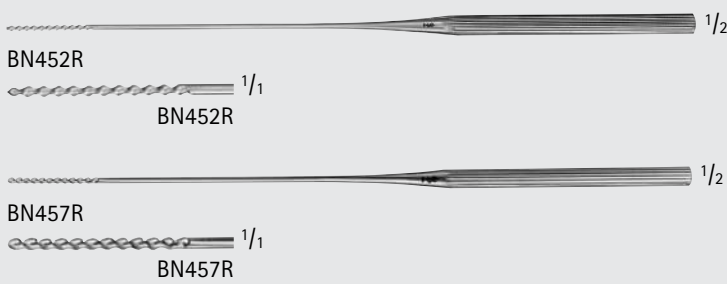

Cotton Applicator, Spiral

Catalog Number	Tip Size (mm)	Length (in.)
BN452R	1.5	7
BN457R	1.8	7

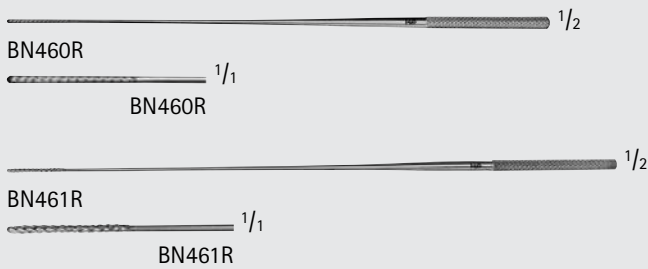

FARRELL Cotton Applicator

Catalog Number	Tip Size (mm)	Tip	Length (in.)
BN460R	1.2	ROUND-SERR	5 1/2
BN461R	1.2	SPIRAL	6 1/4

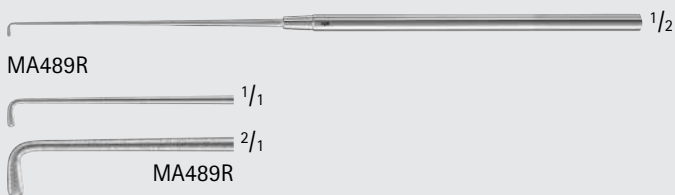

ALLPORT Mastoid Searcher

Catalog Number	Tip Size (mm)	Tip	Length (in.)
MA489R	3	ANG 90°	6 3/4

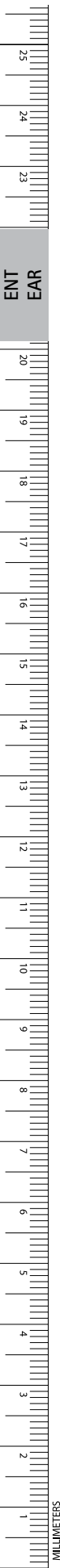

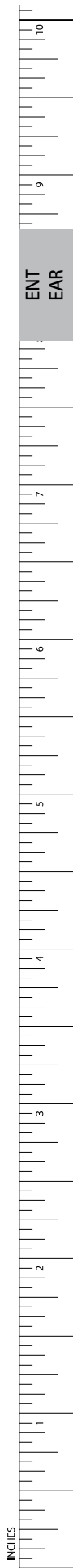

MA230R

Ear Knife Handle, for Myringotomy
Blades with Round Ends

Catalog Number	Length (in.)
MA230R	3 5/8



MA204R



1/1



2/1

MA204R

AUSTIN Dissecting Knife

Catalog Number	Blade Size (mm)	Blade Shape	Length (in.)
MA204R	0.5	ANG 45°	6 1/4



MA210R



1/1



2/1

MA210R



MA209R



1/1



2/1

MA209R

DERLACKI Capsule Knife

Catalog Number	Blade Size (mm)	Blade Shape	Length (in.)
MA210R	0.25	ANG 20°	6 1/4
MA209R	0.5	SLIGHT CVD	6 1/4



OG100R



1/1



2/1

OG100R

Footplate Knife

Catalog Number	Blade Shape	Length (in.)
OG100R	STR	6 1/4

ENT-EAR

Knives

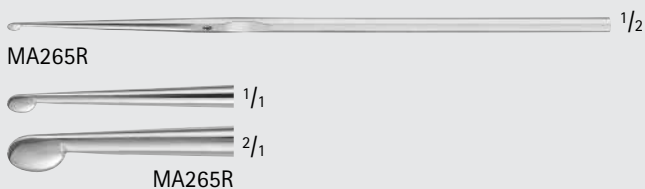

GUILFORD-WRIGHT Flap Knife

Catalog Number	Blade Size (mm)	Length (in.)
MA265R	3.6 x 2.5	6 1/4

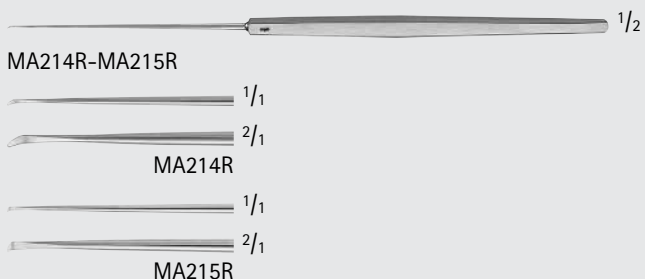

HARRISON Knives

Catalog Number	Size	Blade Shape	Length (in.)
MA214R	SMALL	ANG 45°	6 1/8
MA215R	SMALL	ANG 90°	6 1/8

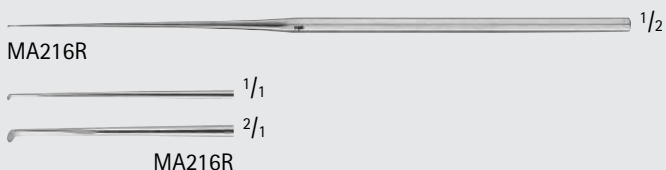

HOUSE Incudostapedial Joint Knife

Catalog Number	Blade Size (mm)	Blade Shape	Length (in.)
MA216R	0.75	ANG 60°	6 5/8

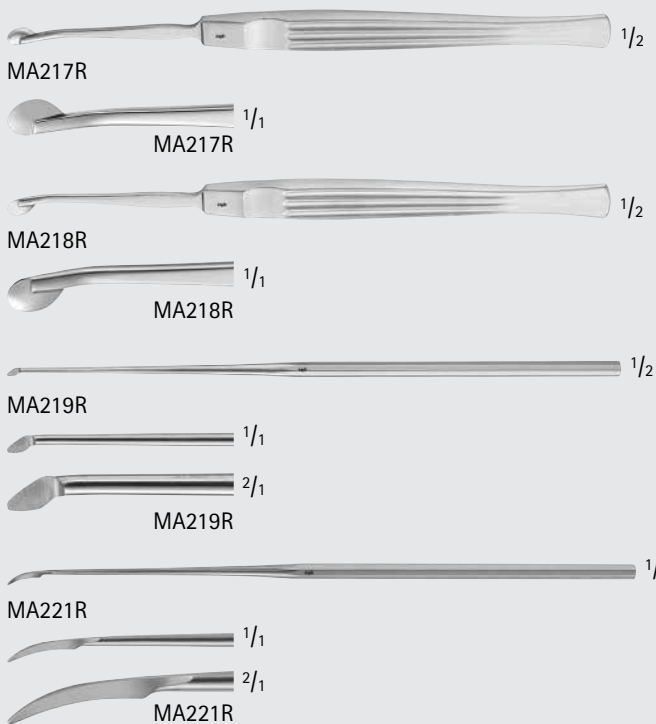

HOUSE Knife

Catalog Number	Blade Size (mm)	Blade Shape	Length (in.)
MA217R	7.0	ANG LEFT	6 1/4
MA218R	7.0	ANG RIGHT	6 1/4
MA219R	2 x 3	ANG 45°	6 1/2
MA221R	7.5	ANG 45°	6 1/2

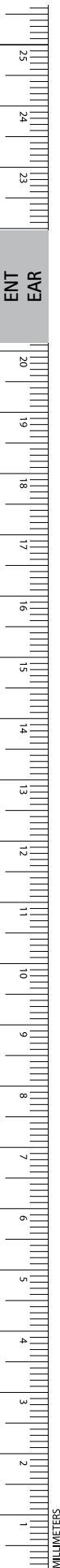



MA213R

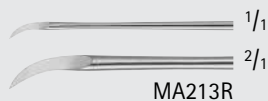

MA213R

GHANDI Knife, Sickle Blade

Catalog Number	Blade Size (mm)	Length (in.)
MA213R	4.0	5 1/8



MA208R



MA208R

CULBERTSON Canal Knife

Catalog Number	Tip Size (mm)	Length (in.)
MA208R	1.4	6 1/4



MA278R



MA278R

JORDAN Canal Knife

Catalog Number	Blade Size (mm)	Blade Shape	Length (in.)
MA278R	2 x 3	ANG 45°	6 1/2



MA222R



MA222R

MCCABE Canal Knife

Catalog Number	Blade Size (mm)	Blade Shape	Length (in.)
MA222R	2.5	ANG 45°	6 1/4



MA227R



MA227R



MA228R



MA228R

PAPARELLA Canal Knife

Catalog Number	Size (#)	Blade Size (mm)	Blade Shape	Length (in.)
MA227R	1	2	STR	6 1/2
MA228R	2	2	STR	6 1/2

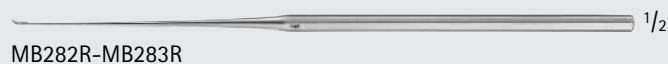

MB282R-MB283R



MB282R



MB283R

PAPARELLA Sickle Knife

Catalog Number	Size (#)	Blade Size (mm)	Blade Shape	Length (in.)
MB282R	14	5	CVD RIGHT	6 1/2
MB283R	15	5	CVD LEFT	6 1/2



INCHES

ENT-EAR

Knives

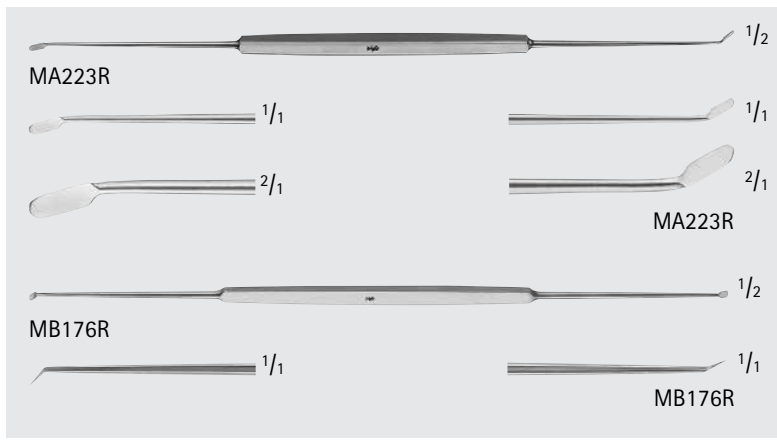
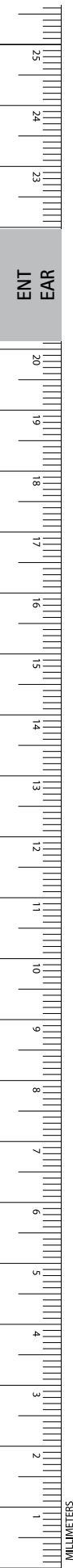

MCCABE Knife Flap Dissector, Double Ended, Angled

Catalog Number	Blade Shape	Length (in.)
MA223R	20° / 45°	7 1/4
MB176R	20° / 40°	7 1/4

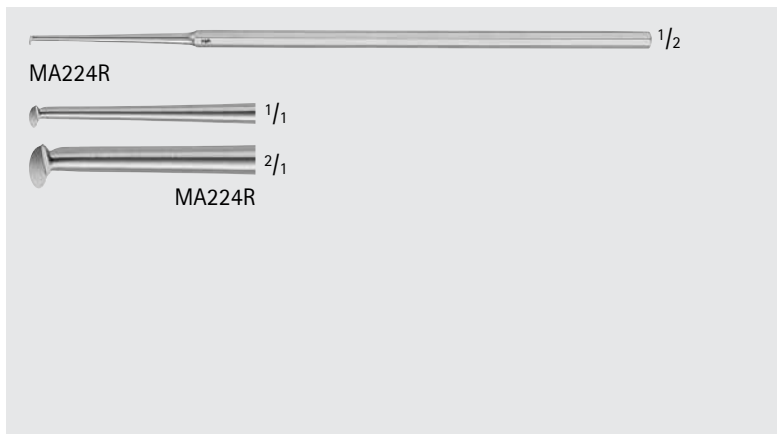

MCHUGH Flap Knife

Catalog Number	Blade Shape	Length (in.)
MA224R	OVAL	6 1/2

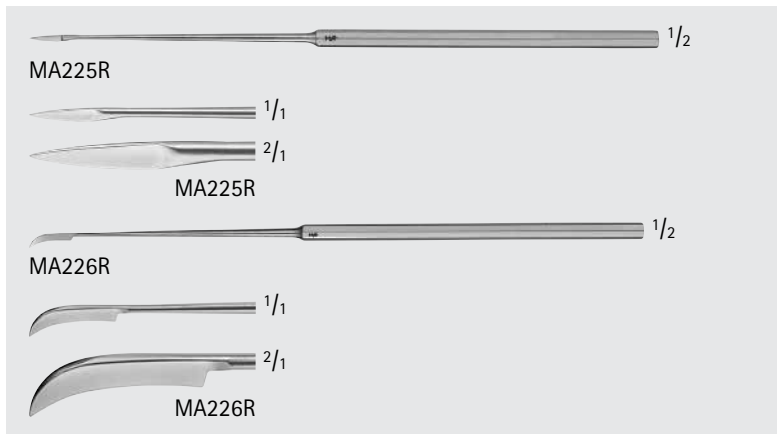

Myringotomy Knife

Catalog Number	Blade Size (mm)	Blade Shape	Length (in.)
MA225R	8	STR	6 1/2
MA226R	9	CVD	6 1/2

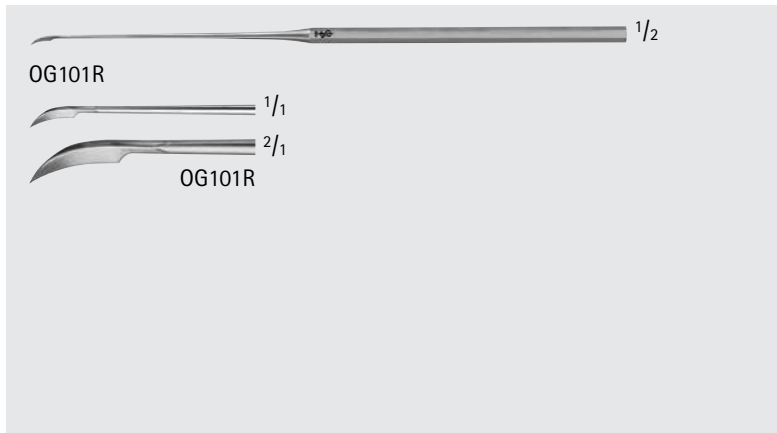

PLESTER Knife, Sickle Knife

Catalog Number	Blade Shape	Length (in.)
OG101R	CVD	6 1/4



OG110R, OG112R, OG133R, OG136R

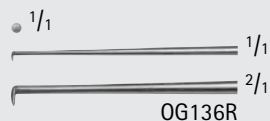
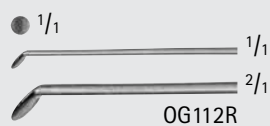
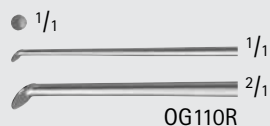
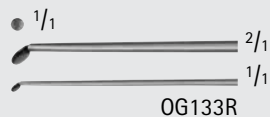

Round Cutting Knife

Catalog Number	Blade Size (mm)	Blade Shape	Length (in.)
OG133R	1.5	45°	6 1/4
OG110R	2.0	45°	6 1/4
OG112R	2.6	45°	6 1/4
OG136R	1.5	90°	6 1/4



OG108R

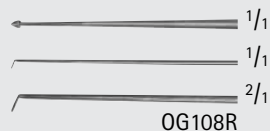

MA292R

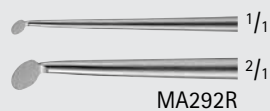

ROSEN Knife

Catalog Number	Blade Size (mm)	Blade Shape	Length (in.)
OG108R	-	SPEAR	6 1/4
MA292R	2	45° UP ROUND	6 1/4



MA644R



ROYCE Ear Knife

Catalog Number	Blade	Blade Size (mm)	Shaft	Length (in.)
MA644R	DOWN-CUTTING	8	ANG	6 1/4

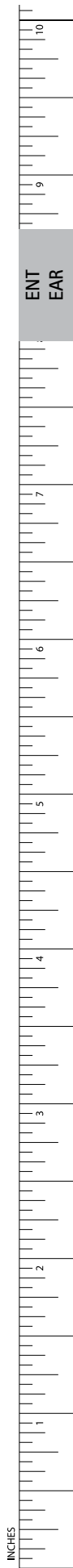

INCHES

ENT-EAR

Knives



OG123R-OG124R



OG123R



OG124R

SCHUKNECHT Roller Knife

Catalog Number	Blade Shape	Length (in.)
OG123R	RIGHT-ANG	6 1/4
OG124R	STR	6 1/4



MA056R-MA057R



MA056R



MA057R

SHEEHY Knife Curette

Catalog Number	Size	Blade Size (mm)	Blade Shape	Length (in.)
MA056R	SMALL	2.0	WEAPON	6 5/8
MA057R	LARGE	2.5	WEAPON	6 5/8



MA586R



MA586R



MA587R



MA587R

Sickle Knife

Catalog Number	Blade Tip	Blade Size (mm)	Blade Shape	Length (in.)
MA586R	SHARP	10	CVD	7 1/2
MA587R	BLUNT	10	CVD	7 1/2

ENT
EAR

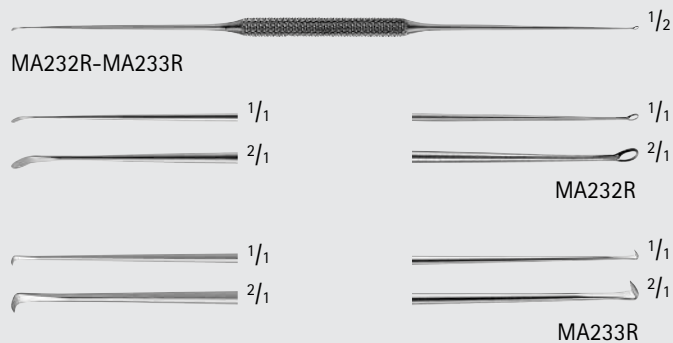

TABB Flap Knife, Double Ended, Angled

Catalog Number	Blade Size (mm)	Blade Shape	Length (in.)
MA232R	0.9 / 1.0	25° / 45°	6 1/2
MA233R	0.9 / 1.0	90° / 115°	6 1/2

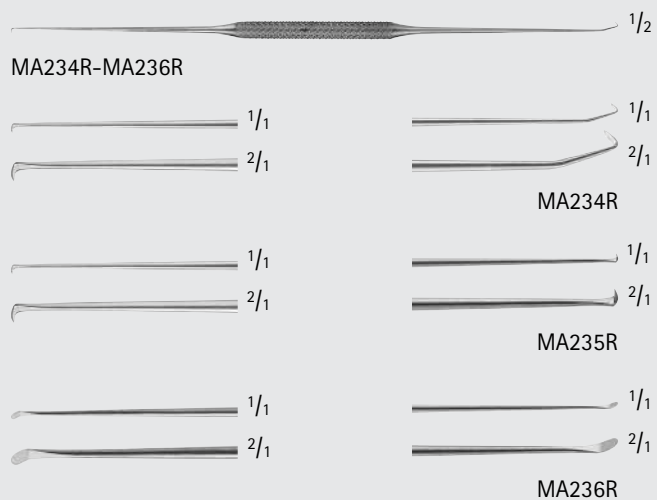

TABB Myringotomy Knife, Double Ended, Angled

Catalog Number	Blade Size (mm)	Blade Shape	Length (in.)
MA234R	1.0 / 1.0	90° / 120°	6 1/4
MA235R	1.3 / 1.3	90° / 115°	6 1/4
MA236R	1.1 / 1.1	25° / 45°	6 1/4

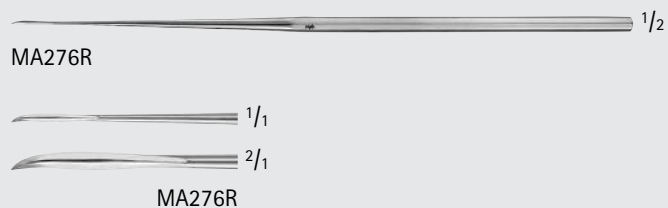

HOUSE Tympanoplasty Knife

Catalog Number	Blade Size (mm)	Blade Shape	Length (in.)
MA276R	7	CVD	6 1/2

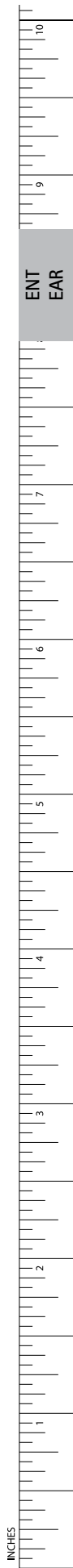

INCHES

ENT-EAR

Suction Irrigation



MA717R-MA718R

ANTHONY Suction Tube, Straight

Catalog Number	Tip Size (mm)	Length (in.)
MA717R	2 I.D.	6 1/8
MA718R	3 I.D.	6 1/8

MA494R

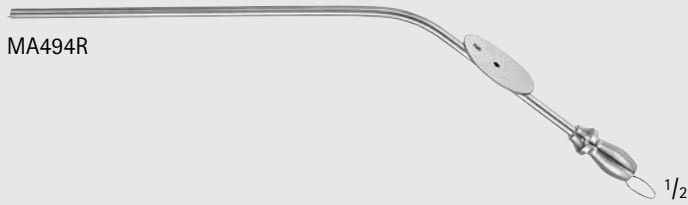

BARNES Hospital Suction Tube

Catalog Number	Tip Size (FR)	Working Length (in.)	Length (in.)
MA494R	9	3 3/4	6 1/8

MB380R-MB382R

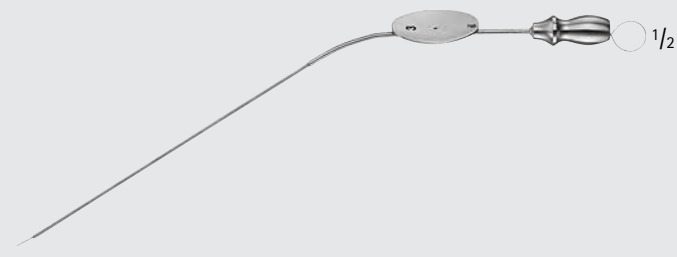

BARON Suction Tube

Catalog Number	Tip Size (FR)	Working Length (in.)	Length (in.)
MB380R	3	4	4
MB381R	5	4	4
MB382R	7	4	4
MD887	3	2 3/4	5 1/2
MD888	5	2 3/4	5 1/2
MD889	7	2 3/4	5 1/2
MG375R	-	-	6

MG375R Stylet may be used with all
BARON Suction Tubes

MD887-MD889



MG375R

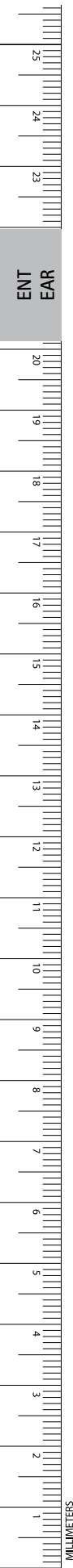
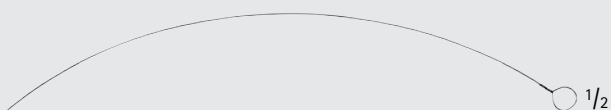

MA502R



MA503R



HOUSE-BARON Suction Tube, Long

Catalog Number	Tip Size (FR)	Working Length (in.)	Length (in.)
MA502R	3	3 5/8	5 1/2
MA503R	5	3 5/8	6 1/8

MA497R



MA498R



MA495R



MA496R



BRACKMANN Suction Tube

Catalog Number	Tip Size (FR)	Working Length (in.)	Length (in.)
MA497R	5	3	6
MA498R	7	3	6
MA495R	5	4 1/8	6
MA496R	7	4 1/8	6

MB614R-MB616R



HOUSE Suction Tube, Straight

Catalog Number	Tip	Length (in.)
MB614R	18 GA	4 1/8
MB615R	20 GA	4 1/8
MB616R	22 GA	4 1/8

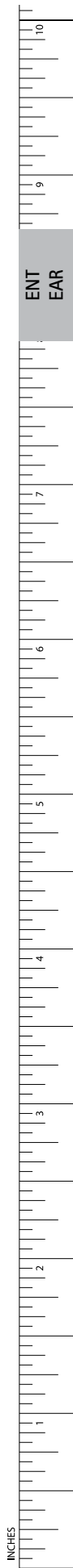

INCHES

ENT-EAR

Suction Irrigation

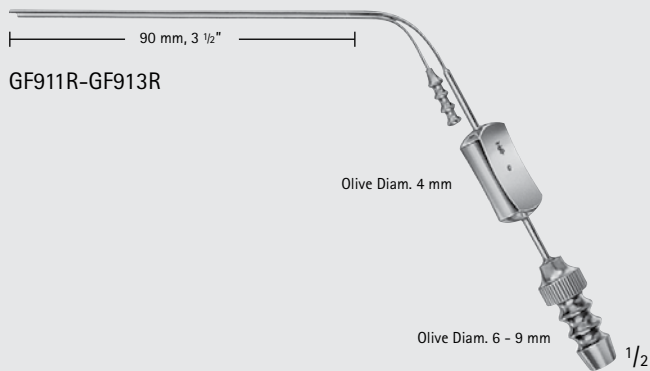

HOUSE Suction Irrigation Cannula

Catalog Number	Tip Size (mm)	Working Length (in.)
GF911R	0.9 / 0.7	3 1/2
GF912R	1.2 / 0.9	3 1/2
GF913R	1.5 / 1.2	3 1/2

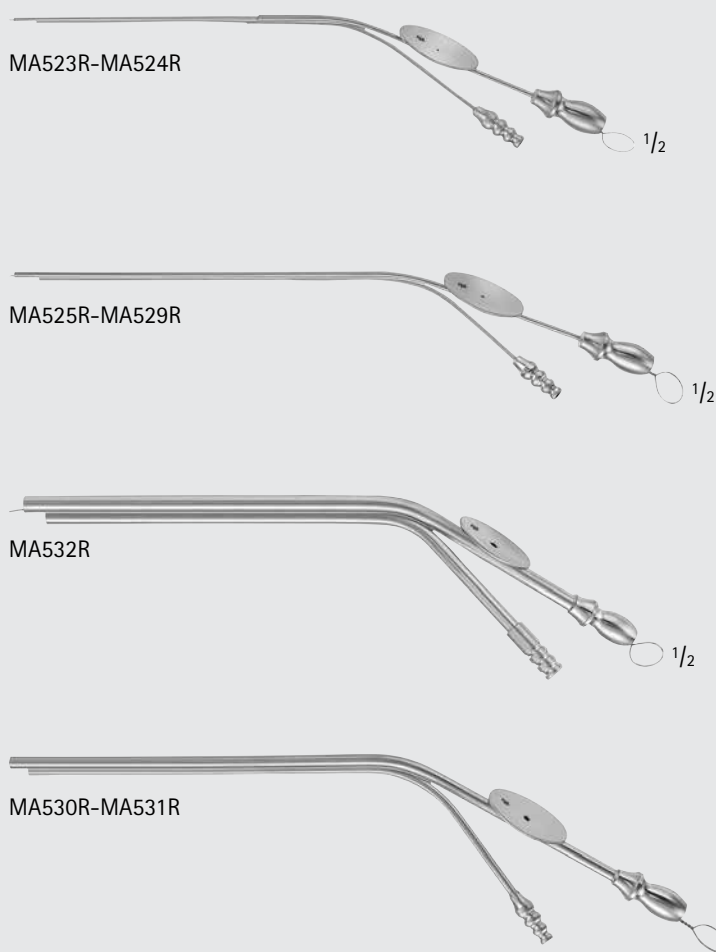

WILLIAM-HOUSE Suction Irrigator

Catalog Number	Tip Size (FR)	Working Length (in.)	Length (in.)
MA524R	2.5 x 4	2 3/4	4 1/2
MA526R	4 x 5	3	4 1/2
MA525R	2.5 x 4	3	5 1/2
MA528R	5 x 7	3	5 1/2
MA529R	6 x 8	3	5 1/2
MA530R	7 x 10	3	5 1/2
MA531R	8 x 12	3	5 1/2
MA532R	12 x 14	3	5 1/2
MA523R	2 x 2.5	3 3/8	5 1/8

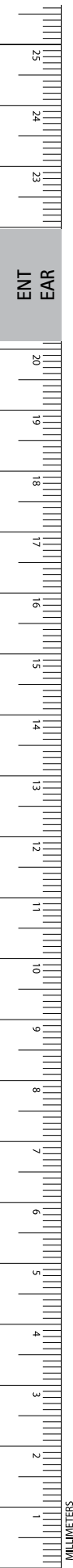

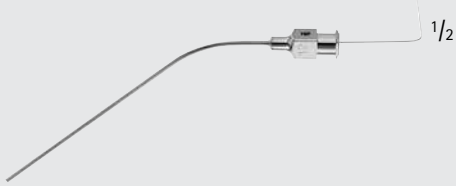

MB450R-MB453R

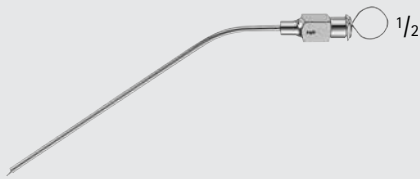

MA513R-MA522R

ROSEN Suction Tube

Catalog Number	Tip	Working Length (in.)	Length (in.)
MB450R	18 GA	2 3/8	3 1/2
MB451R	20 GA	2 3/8	3 1/2
MB452R	22 GA	2 3/8	3 1/2
MB453R	24 GA	2 3/8	3 1/2
MA513R	14 GA	2 3/8	4
MA514R	15 GA	2 3/8	4
MA515R	16 GA	2 3/8	4
MA516R	17 GA	2 3/8	4
MA518R	19 GA	2 3/8	4
MA522R	26 GA	2 3/8	4

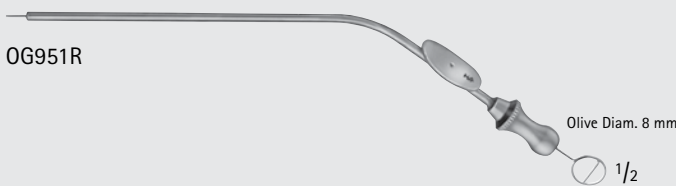

OG951R

BELLUCCI Suction Tube, Detachable Tips

Catalog Number	Diameter (mm)	Description	Length (in.)
OG950R	-	SET	-
OG951R	8	SUCTION TUBE W/ FINGER CUT-OFF AND STYLET	6 1/8

OG950R Includes
1 Suction Tube OG951R and Stylet



GF771R-GF775R

ZOELLNER Suction, Tips Only for GF770R

Catalog Number	Tip	Diameter (mm)
GF771R	18 GA	1.2
GF772R	20 GA	1.0
GF773R	22 GA	0.7
GF774R	24 GA	0.5
GF775R	26 GA	0.4

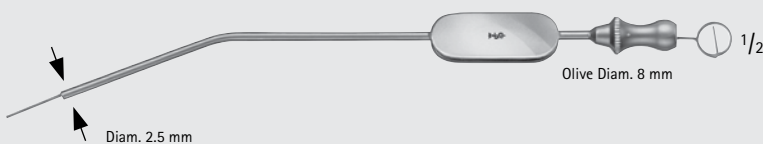

GF770R

ZOELLNER Suction Tube

Catalog Number	Diameter (mm)	Length (in.)
GF770R	2.5	7



GF768R

HOUSE Cut-Off Adapter

Catalog Number	Length (in.)
GF768R	2 1/4

ENT-EAR

Dissectors/Chisels/Gouges

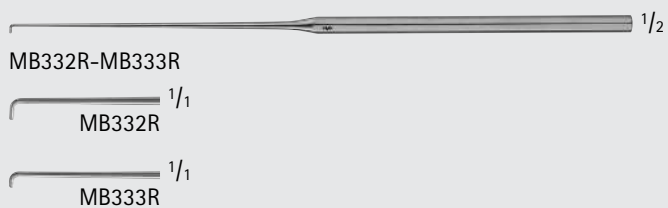

CRABTREE "JIMMY" Dissector

Catalog Number	Tip Size (mm)	Tip	Length (in.)
MB333R	1.3	SMALL	6 1/2
MB332R	2.0	LARGE	6 1/2

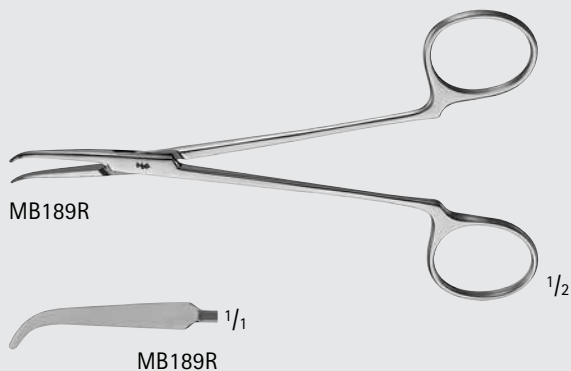

MCCABE Facial Nerve Dissector

Catalog Number	Tip Size (mm)	Jaw	Length (in.)
MB189R	25	ANG	5 1/2

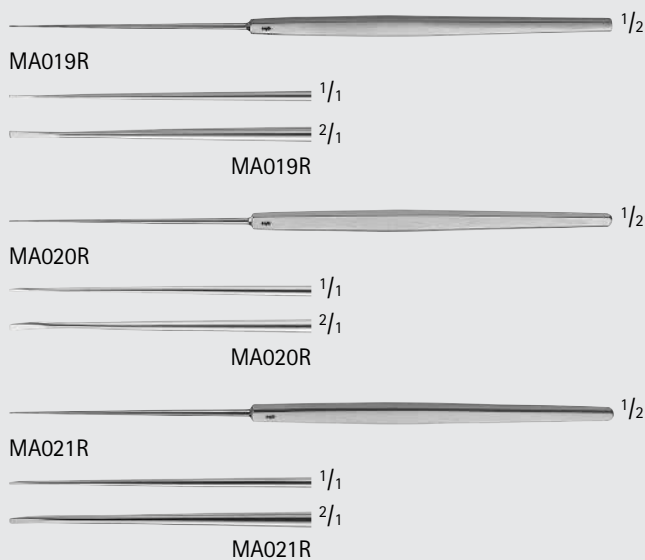

DERLACKI Chisel

Catalog Number	Tip Size (mm)	Blade Shape	Length (in.)
MA019R	0.5	STR	6 1/4
MA020R	0.5	ANG 10°	6 1/4
MA021R	0.5	ANG 20°	6 1/4

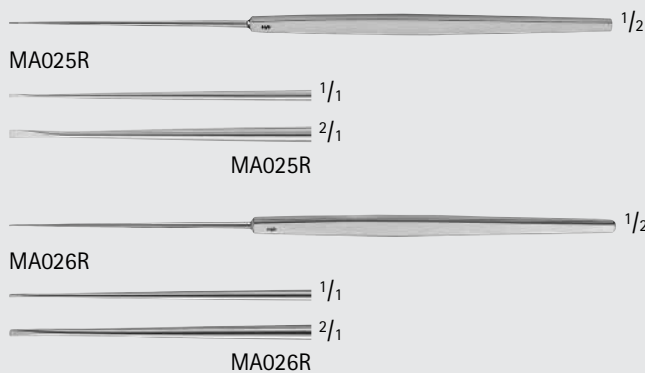

HOUSE Footplate Chisel

Catalog Number	Tip Size (mm)	Blade Shape	Length (in.)
MA025R	0.6	STR	6 1/4
MA026R	0.6	SLIGHT-CVD	6 1/4



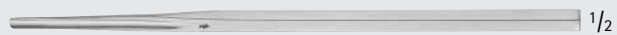

MA175R

1/2



MA176R

1/2

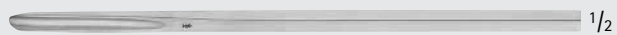

MA177R

1/2

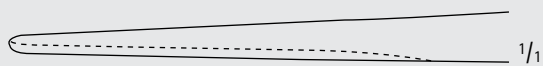

MA175R-MA177R

1/1

BISHOP Mastoid Gouge

Catalog Number	Tip Size (mm)	Length (in.)
MA175R	3	6
MA176R	4	6
MA177R	5	6



MA629R

1/2



MA629R

1/1



MB108R

1/2



MB108R

1/1

PARKES Hump Gouge, Double Guarded

Catalog Number	Tip Size (mm)	Length (in.)
MA629R	6	7
MB108R	10	7

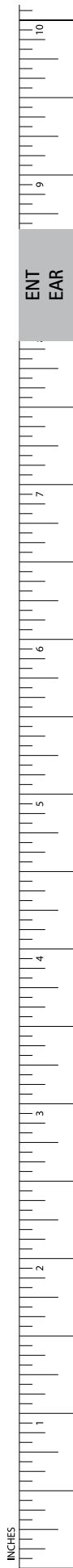

ENT-EAR

Elevators/Scrapers/Excavators

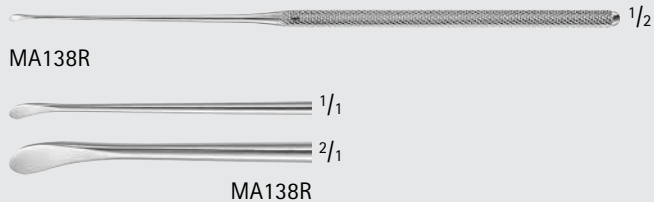

AUSTIN Duckbill Elevator

Catalog Number	Tip Size (mm)	Tip	Length (in.)
MA138R	2	CVD	6 1/4

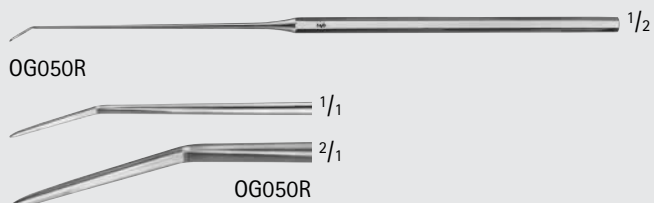

HOUSE Elevator, Angled

Catalog Number	Tip Size (mm)	Tip	Length (in.)
OG050R	1	ANG	6 1/4

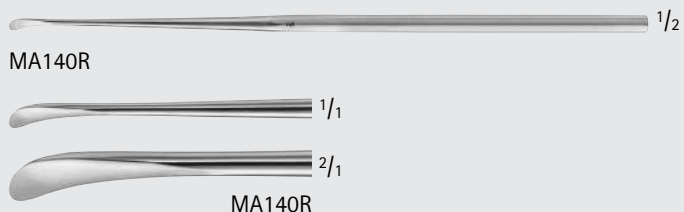

PAPARELLA Duckbill Elevator

Catalog Number	Tip Size (mm)	Size (#)	Length (in.)
MA140R	3	18	6 1/2

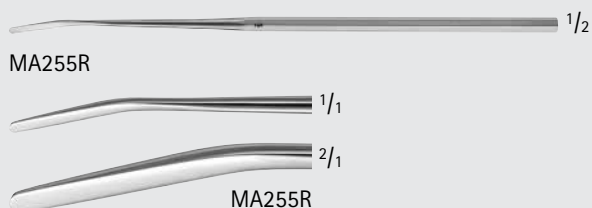

GUILFORD-WRIGHT Drum Elevator, Angled

Catalog Number	Tip Size (mm)	Length (in.)
MA255R	2	5 1/2

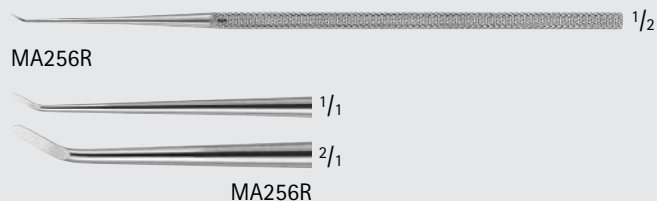

HOUGH Drum Scraper

Catalog Number	Tip Size (mm)	Tip	Length (in.)
MA256R	0.5	ANG 45°	6 1/4

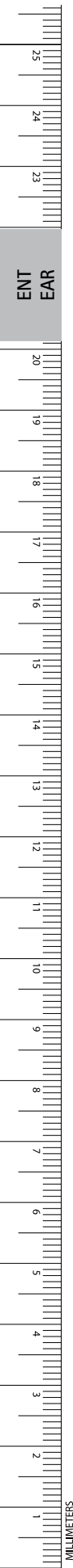

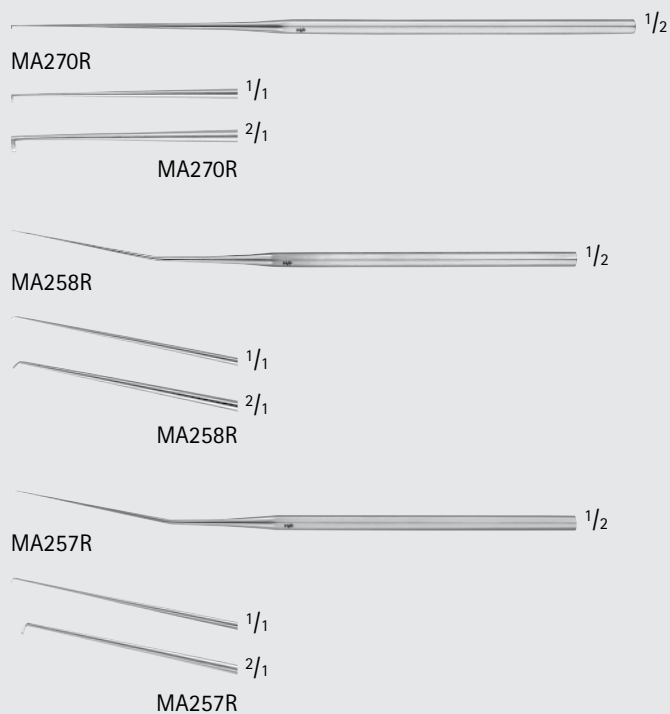

HOUGH Excavator

Catalog Number	Tip Size (mm)	Tip	Length (in.)
MA270R	0.33	ANG 30°	6 1/2
MA258R	0.33	ANG 45°	6
MA257R	0.33	ANG 90°	6

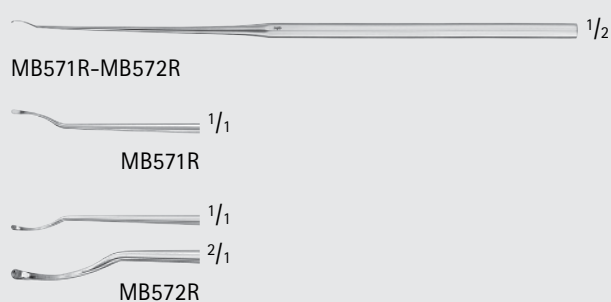

HOUGH Whirlybird Excavator

Catalog Number	Tip Size (mm)	Tip	Length (in.)
MB571R	0.7 x 3.0	CVD-LEFT	6
MB572R	0.7 x 3.0	CVD-RIGHT	6

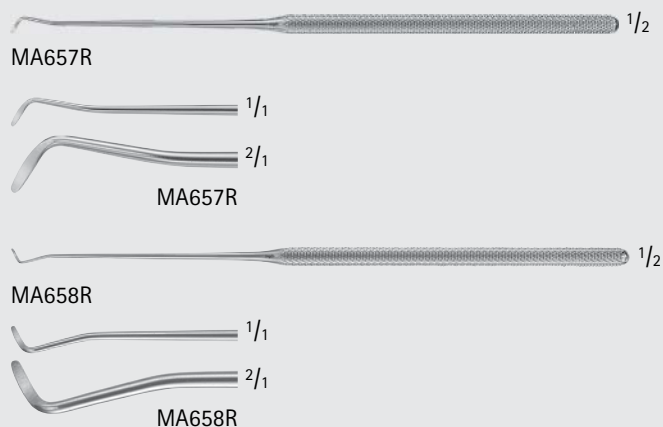

AUSTIN Excavator

Catalog Number	Tip Size (mm)	Tip	Length (in.)
MA657R	1	ANG LEFT	6 1/4
MA658R	1	ANG RIGHT	6 1/4

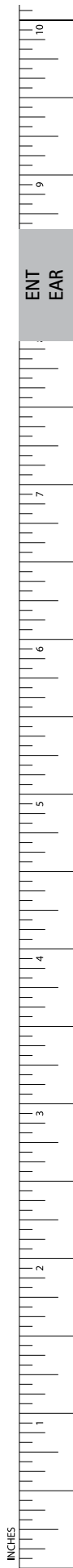

ENT-EAR

Augers/Measurers/Rasps

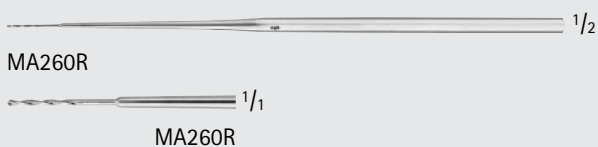

HOUGH Footplate Auger Drill

Catalog Number	Tip Size (mm)	Tip	Length (in.)
MA260R	0.8 x 20.0	DRILL	5 7/8

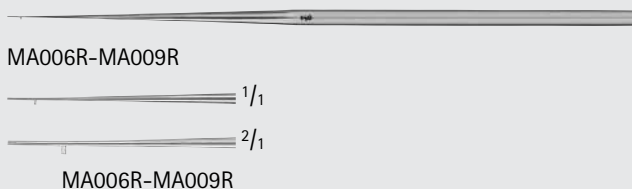

HOUSE-STRUT Measuring Rod W/ Markers

Catalog Number	Tip Size (mm)	Description	Length (in.)
MA006R	3.5	MEASURING ROD 3.5 MM FROM MARKET TO TIP	6 1/2
MA007R	4.0	MEASURING ROD 4.0 MM FROM MARKET TO TIP	6 1/2
MA008R	4.5	MEASURING ROD 4.5 MM FROM MARKET TO TIP	6 1/2
MA009R	5.0	MEASURING ROD 5.0 MM FROM MARKET TO TIP	6 1/2

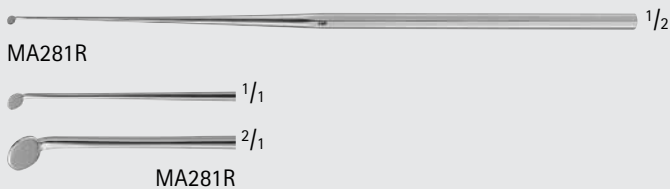

Middle Ear Mirror

Catalog Number	Diameter (mm)	Tip	Length (in.)
MA281R	2	ANG 45°	6 1/2

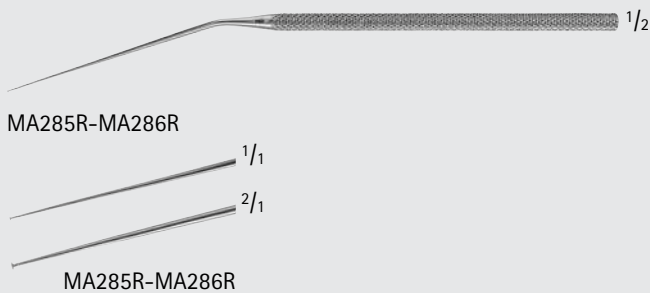

MCGEE Oval Window Rasp

Catalog Number	Size	Length (in.)
MA285R	SMALL	6 3/8
MA286R	LARGE	6 3/8

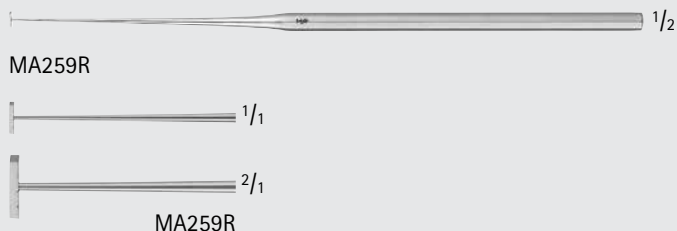

PAPARELLA Fenestrometer

Catalog Number	Blade Size (mm)	Tip Size (#)	Length (in.)
MA259R	1 x 4	13	6 3/8

ENT
EAR

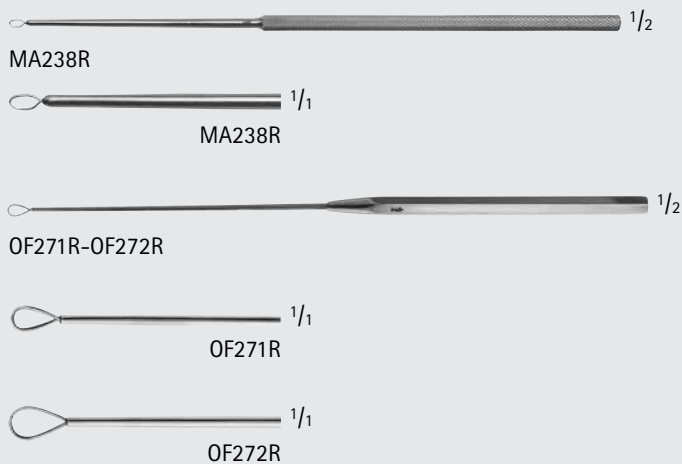

BILLEAU Ear Loop

Catalog Number	Tip Size (mm)	Tip	Length (in.)
MA238R	2	SMALL	6 3/8
OF271R	2	MEDIUM	6 1/4
OF272R	3	LARGE	6 1/4

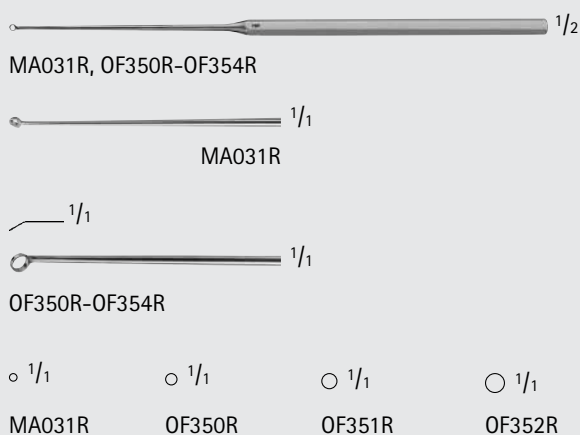

BUCK Ear Curette, Sharp, Curved

Catalog Number	Tip Size (#)	Cup Size (mm)	Length (in.)
MA031R	00	1.0	6
OF350R	00	1.5	6
OF351R	0	2.0	6
OF352R	1	2.5	6
OF353R	2	3.0	6
OF354R	3	4.0	6

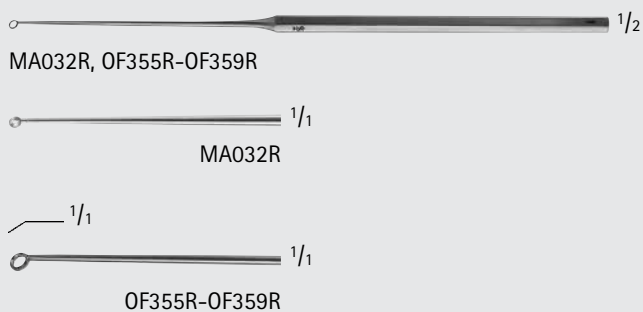

BUCK Ear Curette, Blunt, Curved

Catalog Number	Tip Size (#)	Cup Size (mm)	Length (in.)
MA032R	00	1.0	6
OF355R	00	1.5	6
OF356R	0	2.0	6
OF357R	1	2.5	6
OF358R	2	3.0	6
OF359R	3	4.0	6

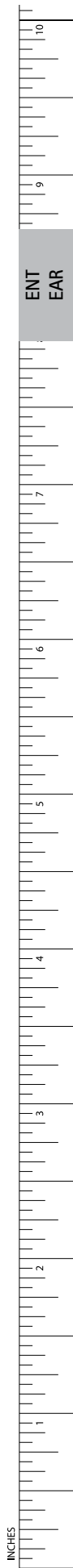
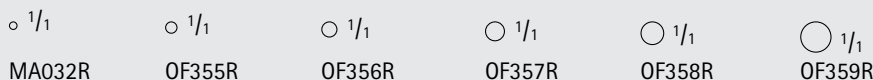

INCHES

ENT-EAR

Curettes/Loops/Spoons



MA252R

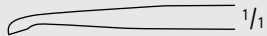

MA252R

HOUGH Ear Curette

Catalog Number	Cup Size (mm)	Tip	Size	Length (in.)
MA252R	2.25 x 3 SERR	ANG 30°	LARGE	5 5/8



MB039R



MB039R



MA279R



MA279R

GUILFORD-WRIGHT Ear Curette, Angled

Catalog Number	Cup Size (mm)	Size	Length (in.)
MB039R	2.4 x 1.4	SMALL	5 1/8
MA279R	2.5 x 3.0	MEDIUM	5 1/4



MA055R



MA055R

SHEA Ear Curette, Round

Catalog Number	Cup Size (mm)	Blade	Length (in.)
MA055R	2	ANG	5 1/2



MA053R-MA054R



MA053R-MA054R

SHAPLEIGH Ear Curette, Angled

Catalog Number	Tip Size (mm)	Tip	Size	Length (in.)
MA053R	1.5	SERR	SMALL	6 1/2
MA054R	2.0	SERR	LARGE	6 1/2

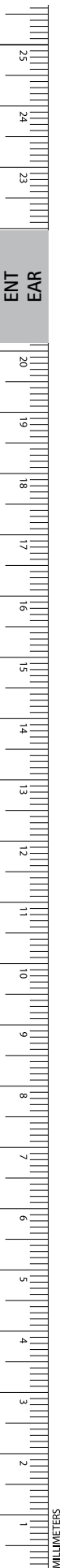



FREIMUTH Ear Curette

Catalog Number	Cup Size (mm)	Tip	Size	Length (in.)
MA653R	2.5 x 4	SERR	SMALL	6 1/4

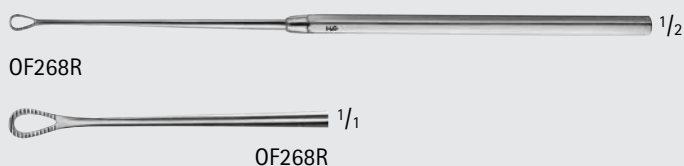

SNELLEN Ear Curette

Catalog Number	Tip	Blade	Length (in.)
OF268R	SERR	CVD	6 1/4



Ear Curette, Pointed, Double Ended

Catalog Number	Cup Size	Length (in.)
OG189R	LARGE	6 3/4

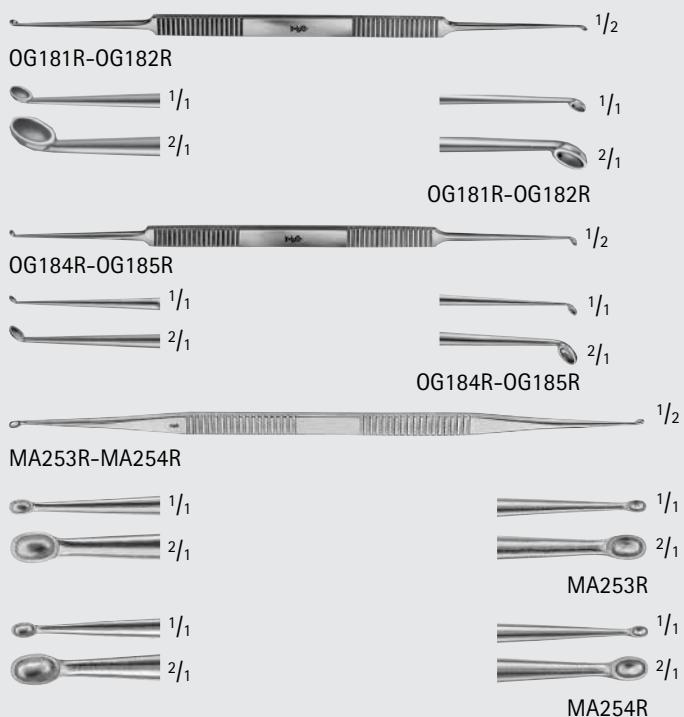

HOUSE Ear Curette, Double Ended

Catalog Number	Cup Size (mm)	Tip	Length (in.)
OG181R	1.0 / 1.2	ANG	6
OG182R	1.5 / 1.8	ANG	6
OG184R	1.0 / 1.2	STRONG ANG	6
OG185R	1.5 / 1.8	STRONG ANG	6
MA253R	2.0 / 1.7	LIGHT ANG	7
MA254R	2.0 / 2.25	STRONG ANG	7

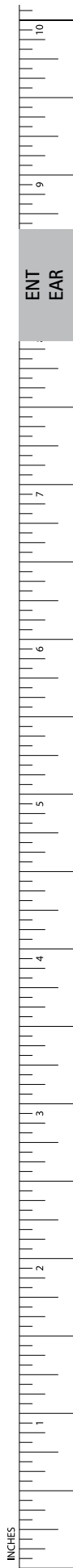

ENT-EAR

Curettes/Loops/Spoons



MA035R



MA035R

HOUSE-PAPARELLA Stapes Ear Curette, Double Ended

Catalog Number	Cup Size (mm)	Length (in.)
MA035R	1.6 x 3.0 / 2.0 x 3.5	6 1/4



MA036R



MA036R

HOUSE Stapes Curette, Double Ended

Catalog Number	Cup Size (mm)	Length (in.)
MA036R	1.8 x 2.5 / 1.5 x 2.4	6



OG180R



OG180R

SHEA Bone Curette, Oval

Catalog Number	Cup Size (mm)	Blade	Length (in.)
OG180R	1.5 x 2.5	STR	6 1/4

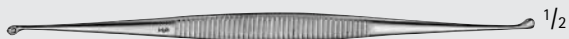

FK800R

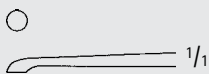

FK800R



FK801R



FK801R

MARTINI Bone Curette, Double Ended

Catalog Number	Cup Size (mm)	Length (in.)
FK800R	3.0 / 3.2	5 1/2
FK801R	4.0 / 3.2	5 1/2

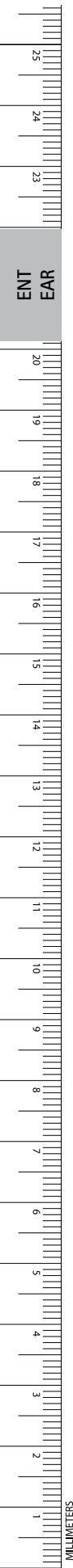



MA051R

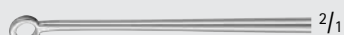

MA051R

PAPARELLA Ring Curette

Catalog Number	Cup Size (#)	Blade	Length (in.)
MA051R	12	ANG	6 1/2



MB117R



MB117R

PRATT Ethmoid Curette, Double Ended

Catalog Number	Blade	Length (in.)
MB117R	SOLID/FENESTRATED	9 1/4



MA188R



MA188R

GROSS Ear Hook/Spoon, Double Ended

Catalog Number	Hook	Spoon	Length (in.)
MA188R	90° BLUNT 2.6 MM	3.2 x 7.5 MM	5 1/4

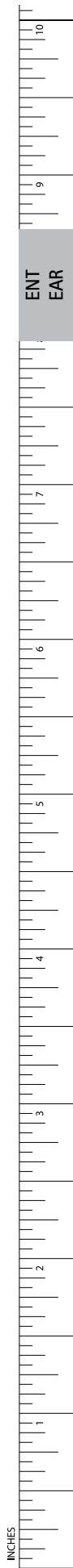

INCHES

ENT-EAR

Rongeurs



MA439R-MA442R

KERRISON Mastoid Rongeur, 90° Up

Catalog Number	Tip Size (#)	Jaw Size (mm)	Working Length (in.)	Length (in.)
MA439R	0	3.5 x 9	4 1/8	6 3/4
MA440R	1	4.0 x 9	4 1/8	6 3/4
MA441R	2	4.5 x 9	4 1/8	6 3/4
MA442R	3	5.0 x 9	4 1/8	6 3/4



MA439R



MA440R



MA441R



MA442R

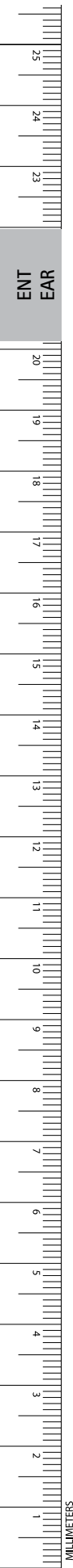

ENT-EAR Tuning Forks



OF001N-OF006N

HARTMANN Tuning Fork

Catalog Number	Frequency
MB575A	c 64
OF001N	c 128
OF002N	c1 256
OF003N	c2 512
OF004N	c3 1024
OF005N	c4 2048
OF006N	c5 4096



MB575A

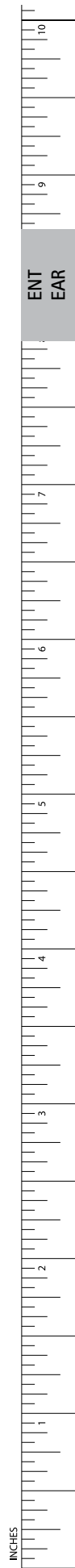

INCHES

ENT-EAR

Miscellaneous

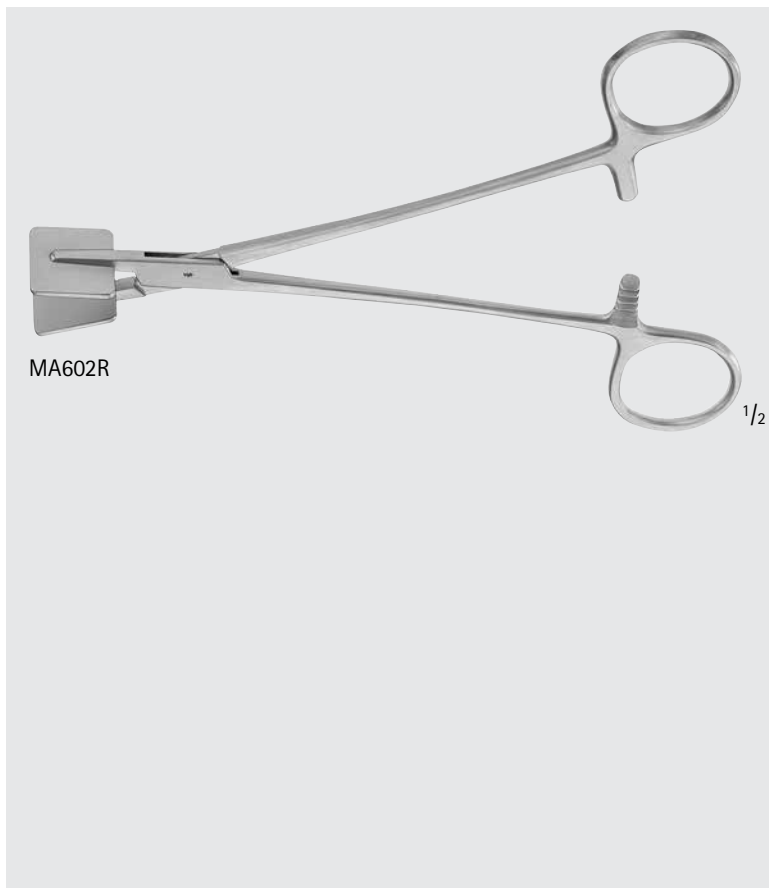
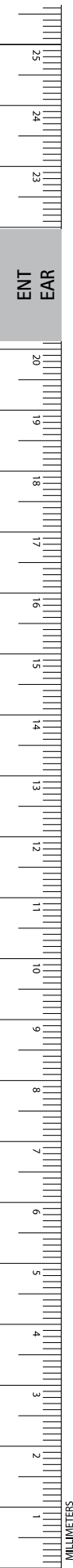

SHEEHY Fascia Press

Catalog Number	Jaw Size (mm)	Jaw	Description	Length (in.)
MA602R	23 x 31	PLATE	W/ RATCHET BOX LOCK	7 1/2

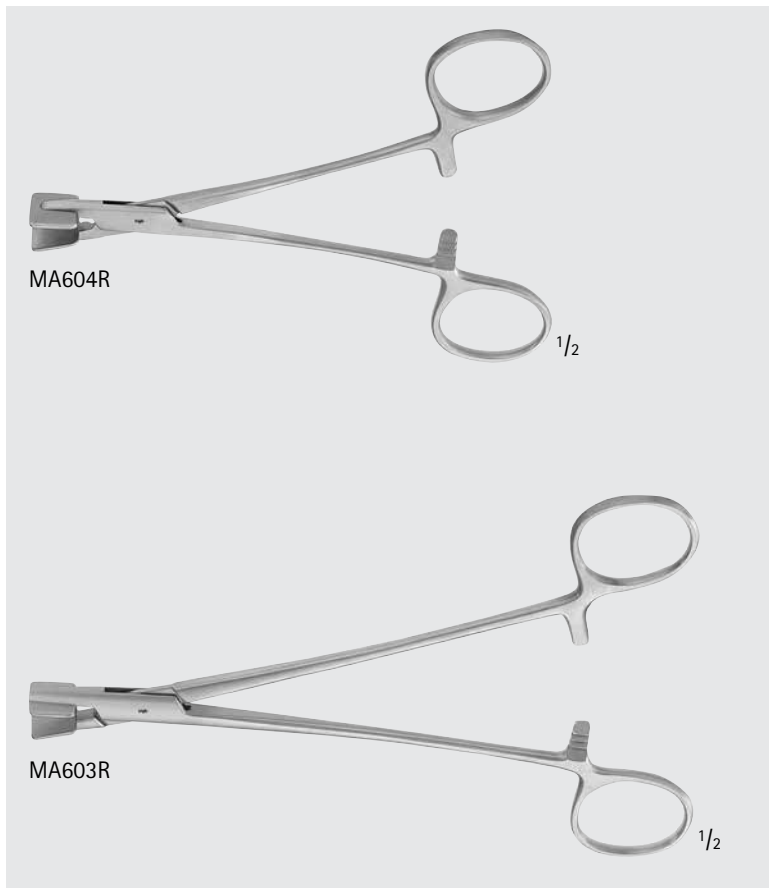

HOUSE Gelfoam Press, with Ratchet

Catalog Number	Jaw Size (mm)	Jaw	Length (in.)
MA604R	12 x 15	PLATE	5 3/8
MA603R	12 x 16	PLATE	7



MA605R

HOUSE Cutting Block, Delrin

Catalog Number	Dimensions (mm)	Description	Length (in.)
MA605R	8 x 38	AUTOCLAVABLE	2 7/8



OG145R

Surgery Preparation Base W/ mm Scale

Catalog Number	Dimensions (mm)
OG145R	92 x 54

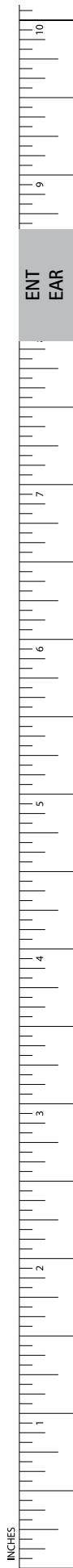

INCHES

ENT-EAR

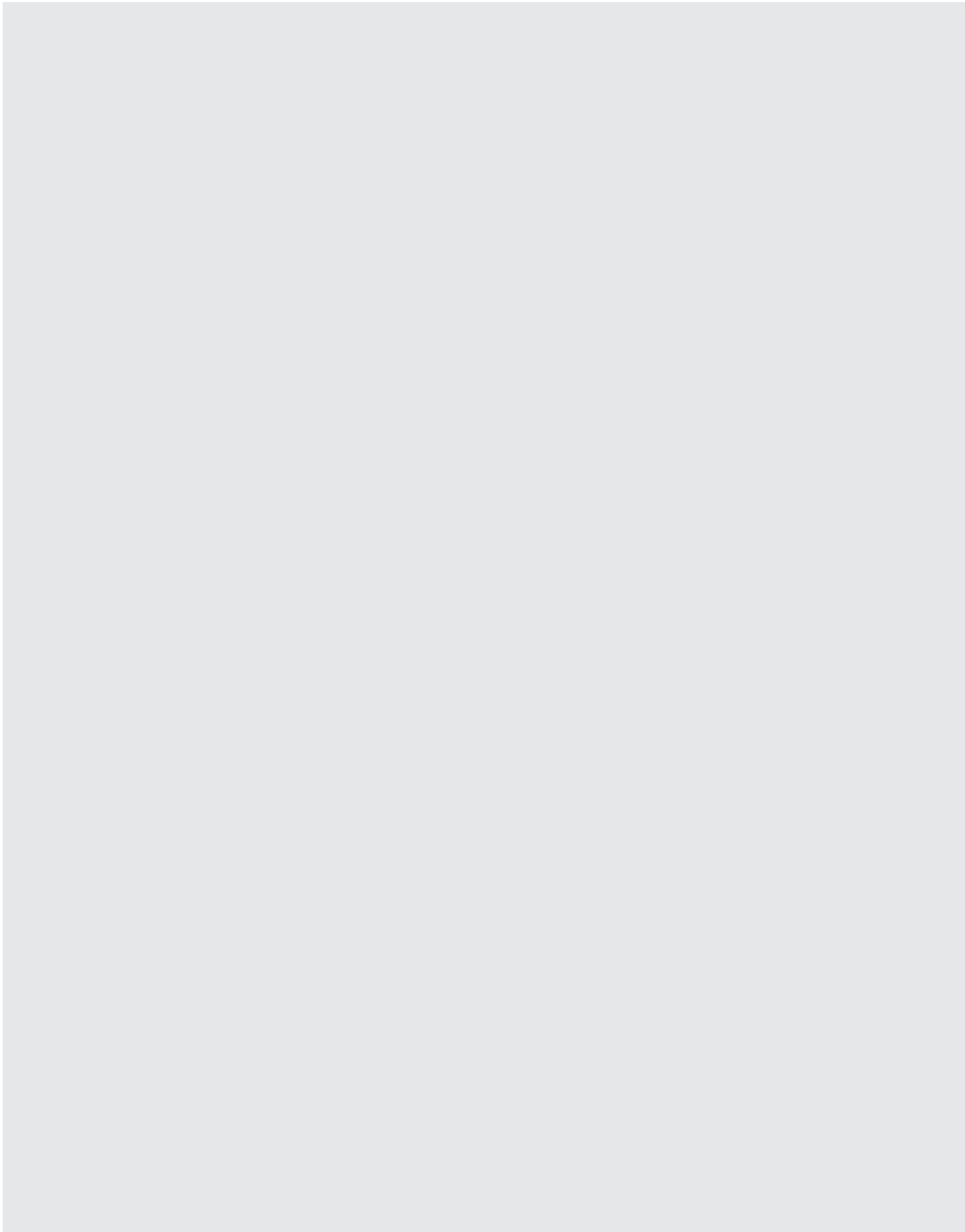
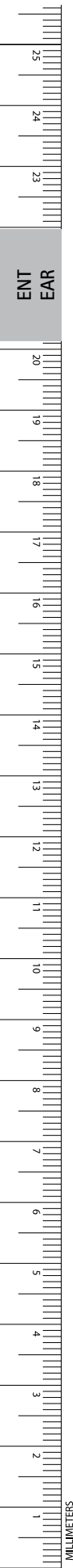



ENT-Nasal

Scissors	596 - 614
Trocar, Needles and Needle Holders	615 - 617
Forceps	618 - 649
Nasal Snares and Wires	650
Hooks	651
Retractors	652 - 657
Elevators and Dissectors	658 - 664
Specula	665 - 673
Rasps, Files and Saws	674 - 677
Chisels and Gouges	678 - 679
Osteotomes	680 - 685
Applicators and Probes	686
Knives	687 - 688
Suction and Irrigation	689 - 692
Mallets, Hammers and Tamps	693 - 694
Curettes	695 - 698
Rongeurs	699 - 703

ENT-NASAL

Scissors

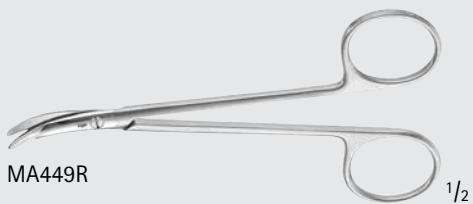

MA449R

1/2

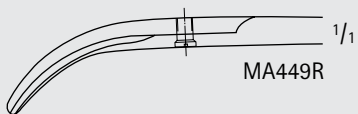

MA449R

1/1

CINELLI Lower Lateral Scissors

Catalog Number	Blade	Length (in.)
MA449R	STRONG CVD	4 3/8

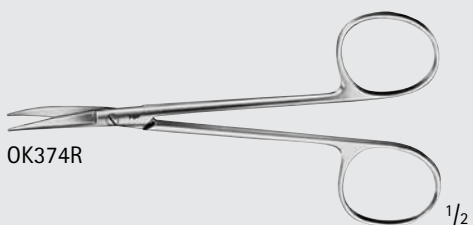

OK374R

1/2

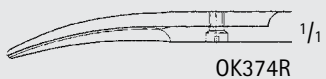

OK374R

1/1

COTTLE Bulldog Scissors

Catalog Number	Tip	Blade	Length (in.)
OK374R	B/B	CVD	4 1/2

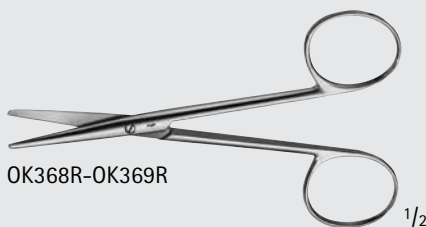

OK368R-OK369R

1/2

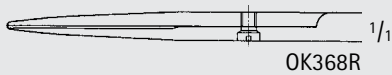

OK368R

1/1

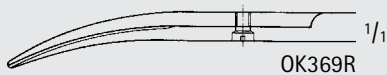

OK369R

1/1

COTTLE-KNAPP Plastic Scissors

Catalog Number	Tip	Blade	Length (in.)
OK368R	B/B	STR	4 1/8
OK369R	B/B	CVD	4 1/8



OK365R-OK367R

1/2

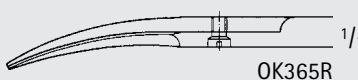

OK365R

1/1

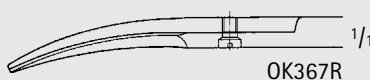

OK367R

1/1

COTTLE-MASING Plastic Scissors

Catalog Number	Tip	Blade	Length (in.)
OK365R	S/S	CVD	4 1/8
OK367R	B/B	CVD	4 1/8

ENT
NASAL

MILLIMETERS

DAVIS Rhytidectomy Scissors

Catalog Number	Blade	Length (in.)
MA450R	CVD	6 3/4

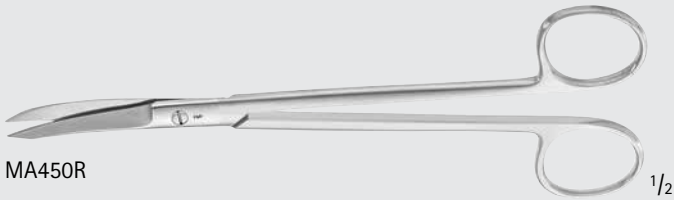

MA450R

1/2

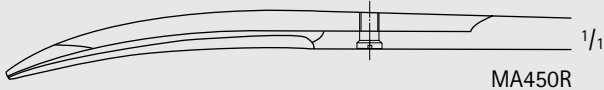

MA450R

1/1

Rhinoplasty Scissors

Catalog Number	Tip	Blade	Length (in.)
MG086R	B/B	FLAT, CVD	5 1/4

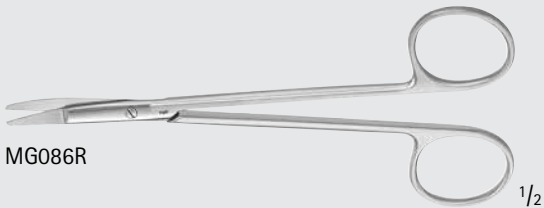

MG086R

1/2

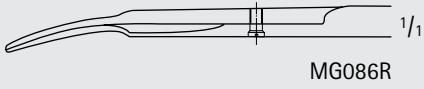

MG086R

1/1

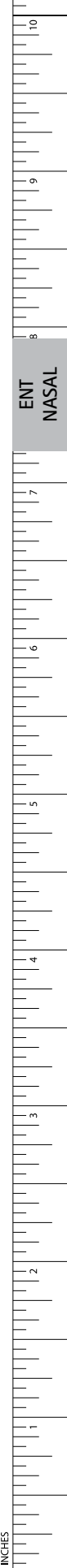

ENT-NASAL

Scissors

MA335R-MA337R

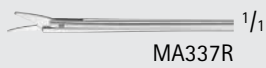
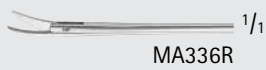

Nasal Scissors, Pediatric

Catalog Number	Blade	Blade Size (mm)	Length (in.)
MA335R	STR	6	4
MA336R	CVD-RIGHT	5.5	4
MA337R	CVD-LEFT	5.5	4

MA318R, MA600R, MA599R

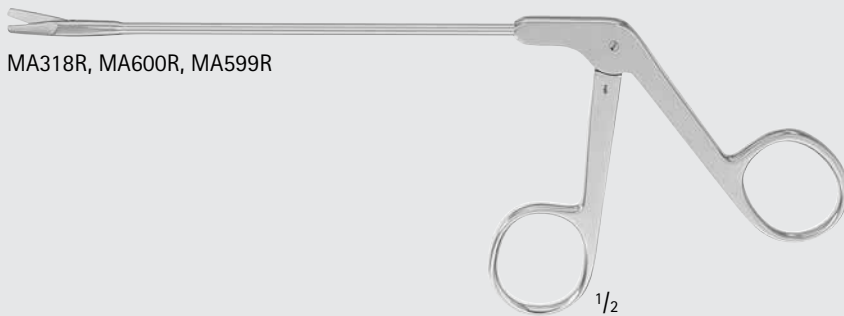

Nasal Scissors, Adult

Catalog Number	Blade	Blade Size (mm)	Working Length (in.)
MA318R	STR	11	5 1/8
MA600R	RIGHT	11	5 1/8
MA599R	LEFT	11	5 1/8

ENT
NASAL

MILLIMETERS



MA609R

LAKESIDE Nasal Scissors

Catalog Number	Blade	Length (in.)
MA609R	STR	7 1/4

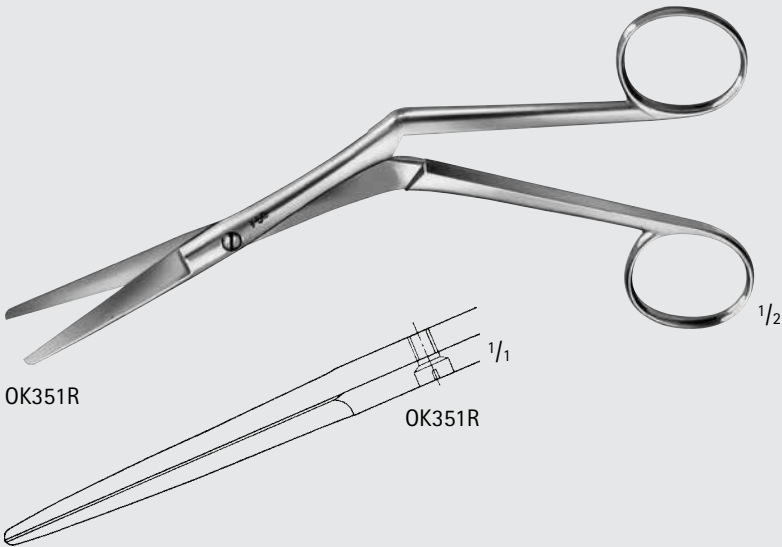

OK351R

HEYMANN Nasal Scissors

Catalog Number	Tip	Blade	Length (in.)
OK351R	B/B	STR	7 1/2

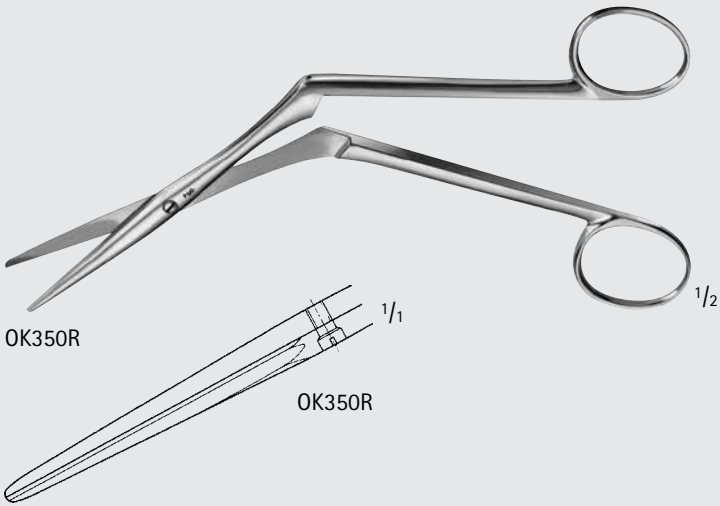

OK350R

HEYMANN-KNIGHT Nasal Scissors

Catalog Number	Tip	Blade	Length (in.)
OK350R	B/B	STR	6 7/8



ENT-NASAL

Scissors

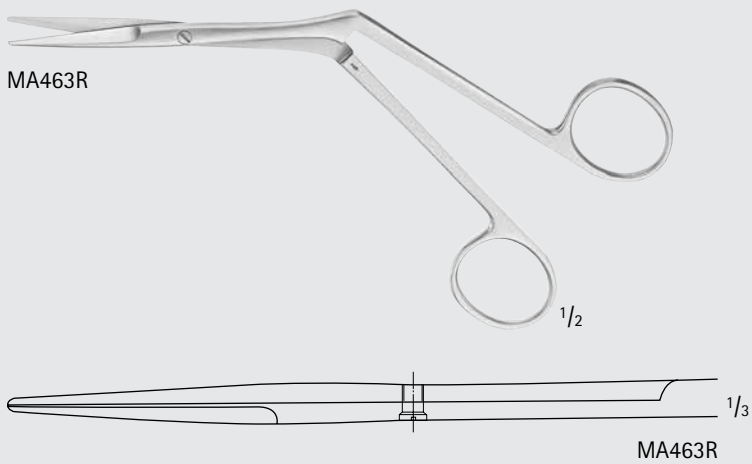

KNIGHT Nasal Scissors, Lightweight, Delicate

Catalog Number	Blade	Tip	Length (in.)
MA463R	STR	DEL	6 3/8

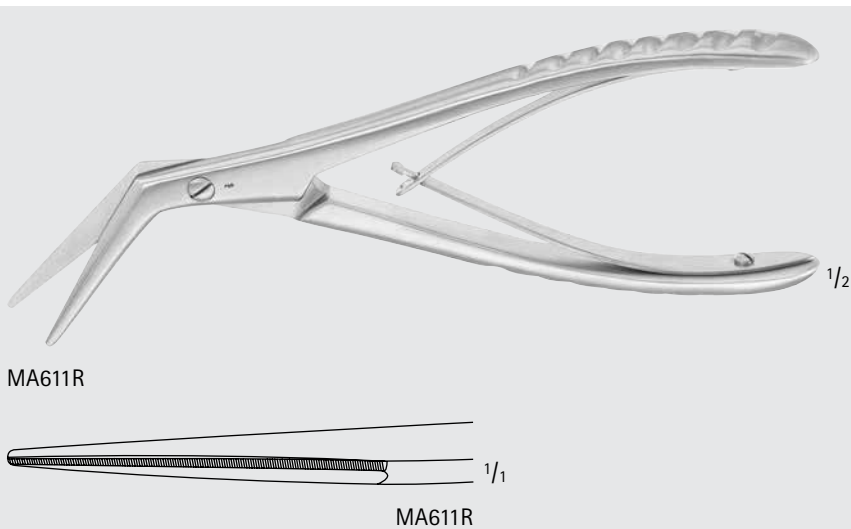

JACKSON Nasal Bone Scissors

Catalog Number	Blade	Length (in.)
MA611R	ANG	8 1/2

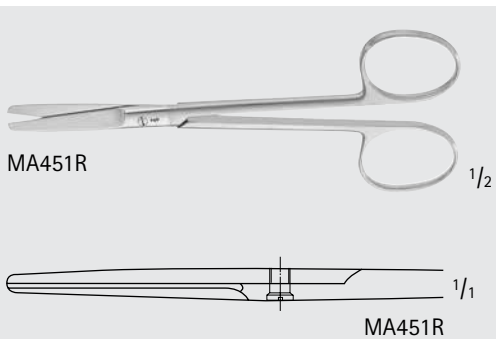

Dorsal Scissors

Catalog Number	Tip	Blade	Length (in.)
MA451R	BLUNT	STR	4 3/4

ENT
NASAL

MILLIMETERS

FOMON Dorsal Scissors

Catalog Number	Tip	Blade	Handle	Length (in.)
MA452R	B/B	SERR	ANG	5 3/4
OK370R	B/B	SERR	ANG	5 3/4

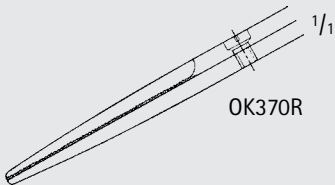
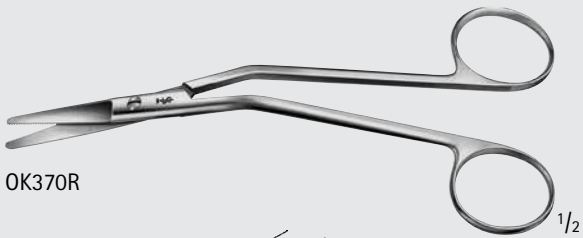
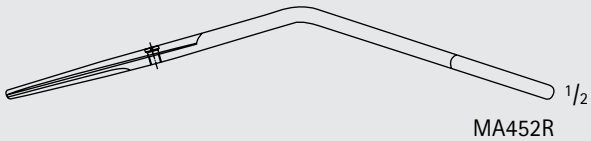

FOMON Lower Lateral Scissors

Catalog Number	Tip	Blade	Length (in.)
OK373R	B/B	HEAVY-CVD	4 1/2
OK372R	B/B	HEAVY-CVD	5 1/4

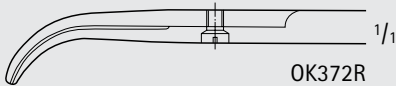
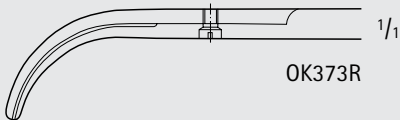
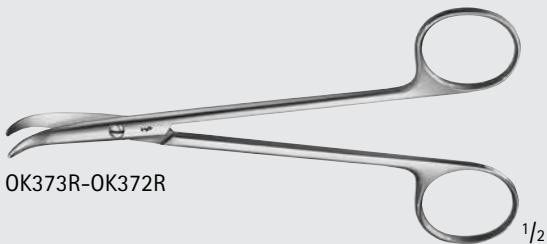

FOMON Saber-Back Scissors

Catalog Number	Tip	Blade	Length (in.)
MB140R	B/B	CVD, SERR	5



ENT-NASAL

Scissors

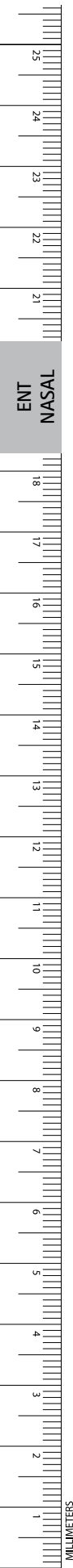

MA453R

1/2

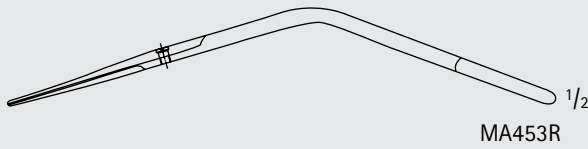

MA453R

GOLDMAN Septum Scissors

Catalog Number	Blade	Length (in.)
MA453R	STR, SERR	5 3/4

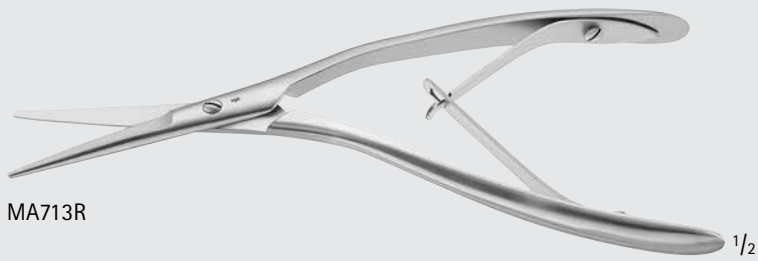

MA713R

1/2



MA713R

1/2

COTTLE Septum Scissors

Catalog Number	Blade	Length (in.)
MA713R	HEAVY, ANG	7 1/2

GORNEY Turbinate Scissors, Double Action

Catalog Number	Jaw	Length (in.)
MA455R	SERR	8

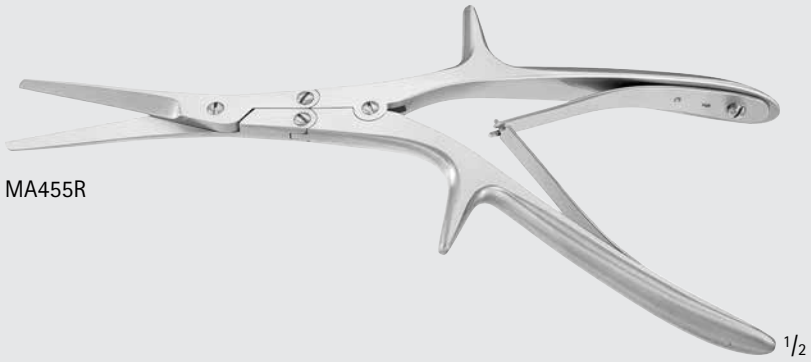

MA455R

1/2



1/2

MA455R

Becker Septum Scissors, Double Joint

Catalog Number	Blade	Length (in.)
OK353R	SERR	7

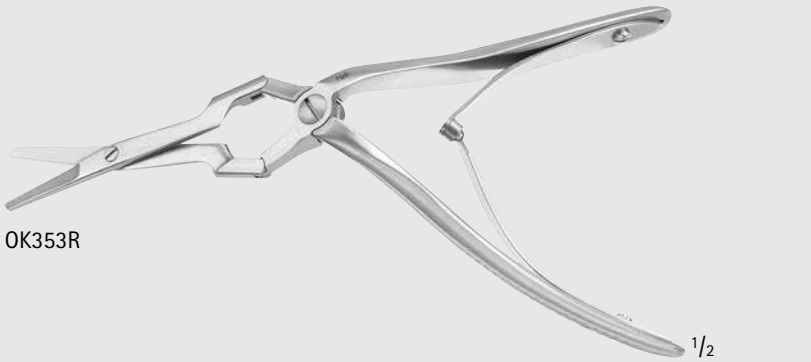

OK353R

1/2



1/1

OK353R



INCHES

ENT-NASAL

Scissors

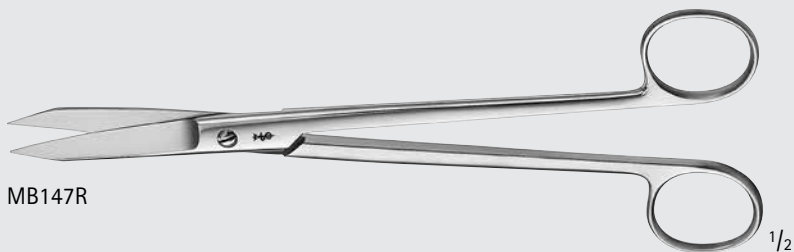

MB147R



MB147R

MARTIN Cartilage Scissors

Catalog Number	Blade	Length (in.)
MB147R	CVD, SERR	8



MB150R

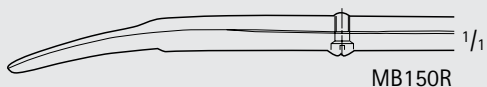

MB150R

METZENBAUM-LIPSETT Scissors

Catalog Number	Tip	Blade	Length (in.)
MB150R	B/B	CVD	5 1/2



MA709R

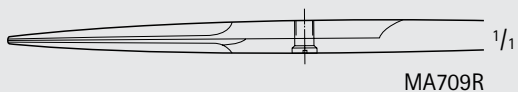

MA709R

PECK-JOSEPH Scissors

Catalog Number	Blade	Tip Size (mm)	Length (in.)
MA709R	STR, SHARP	42	5 3/4

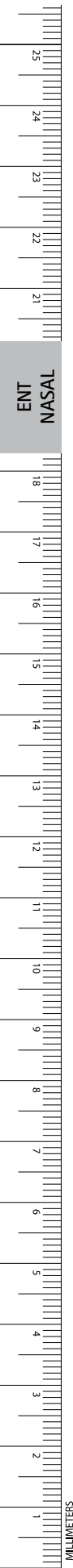

JOSEPH Scissors, Delicate

Catalog Number	Tip	Blade	Handle	Length (in.)
MB174R	S/S	STR, SERR	ROUND	5 1/2
MB175R	S/S	CVD, SERR	ROUND	5 1/2
BC156R	S/S	STR	ROUND	6
BC157R	S/S	CVD	ROUND	6
BC006R	S/S	STR	SQUARE	6
BC007R	S/S	CVD	SQUARE	6

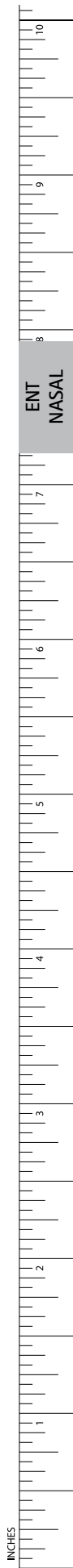
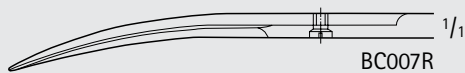
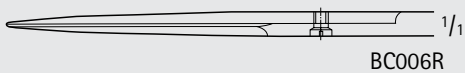
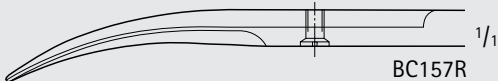
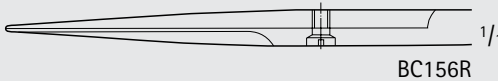
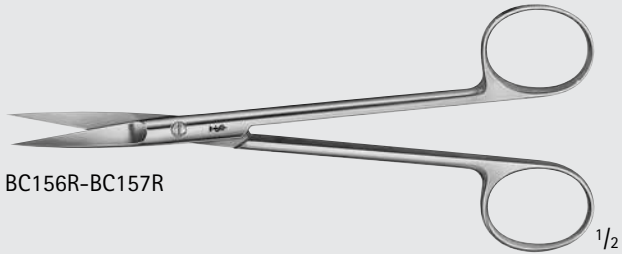
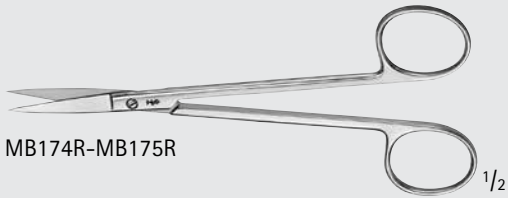

ENT
NASAL

INCHES

ENT-NASAL

Scissors

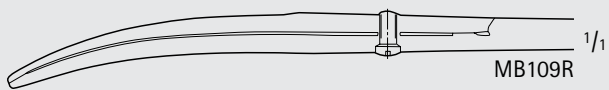
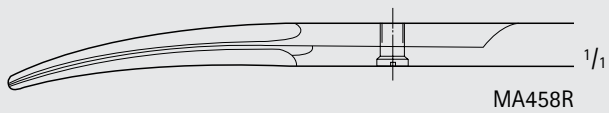
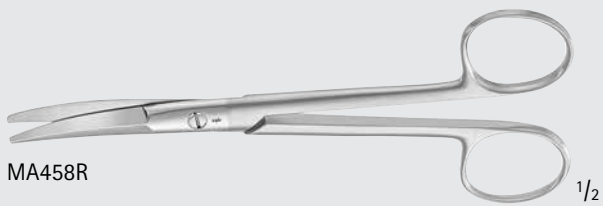

KAYE Facelift Scissors

Catalog Number	Tip	Blade	Length (in.)
MA458R	SEMI-SHARP	CVD, SERR	6
MB109R	SEMI-SHARP	CVD, SERR	7 1/2

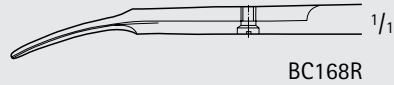
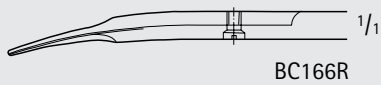
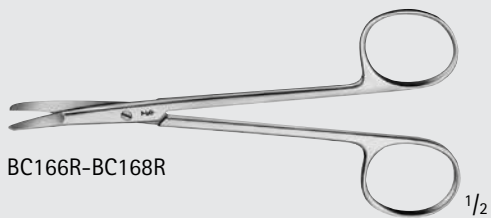

KILNER Scissors

Catalog Number	Tip	Blade	Length (in.)
BC166R	FLAT	CVD	5
BC168R	FLAT	CVD	6

ENT
NASAL

MILLIMETERS

JAMESON Tenotomy Scissors, Delicate

Catalog Number	Tip	Blade	Length (in.)
BC177R	B/B	CVD	6

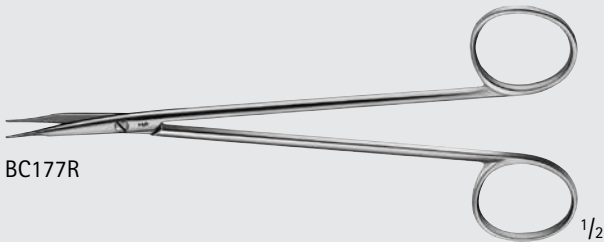

BC177R

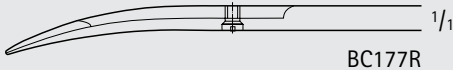

BC177R

REYNOLDS-JAMESON Tenotomy Scissors, Delicate

Catalog Number	Tip	Blade	Handle	Length (in.)
BC015R	B/B	CVD	SQUARE	5 1/2

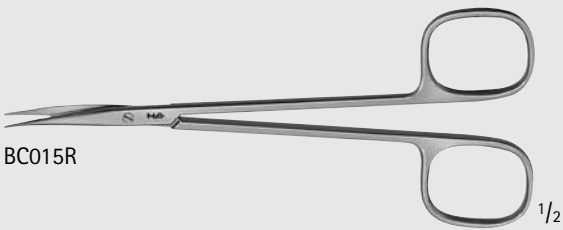

BC015R

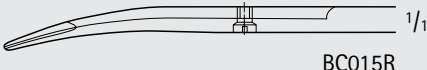

BC015R

REYNOLDS Tenotomy Scissors, Delicate

Catalog Number	Tip	Blade	Length (in.)
BC180R	B/B	CVD	5 3/4
BC181R	B/B	CVD	6 7/8

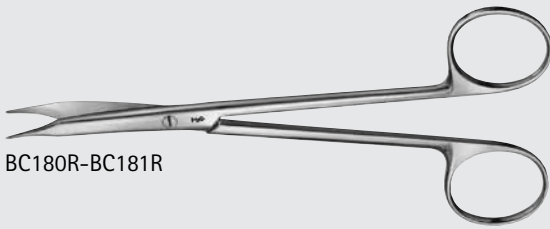

BC180R-BC181R

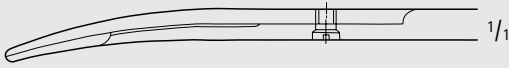

BC180R

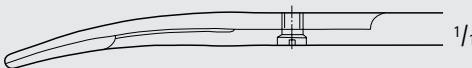

BC181R

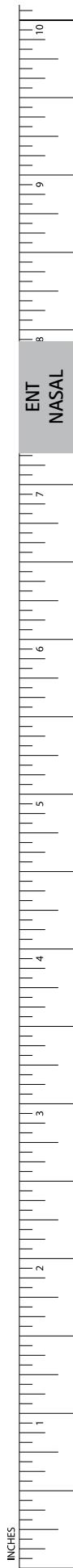

ENT-NASAL

Scissors

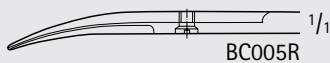
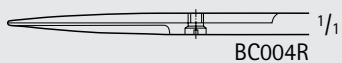
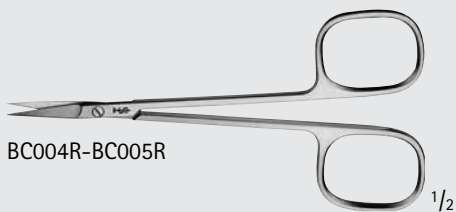

Iris Scissors, Delicate

Catalog Number	Tip	Blade	Handle	Length (in.)
BC004R	S/S	STR	SQUARE	4 1/2
BC005R	S/S	CVD	SQUARE	4 1/2

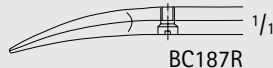
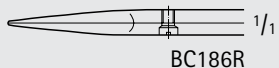
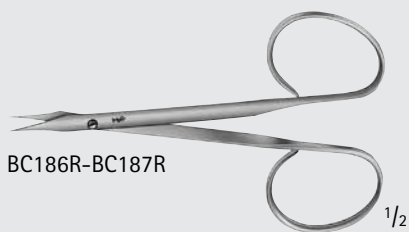

STEVENS Tenotomy Scissors, Delicate

Catalog Number	Tip	Blade	Handle	Length (in.)
BC186R	S/S	STR	RIBBON	4
BC187R	S/S	CVD	RIBBON	4
OK366R	B/B	CVD	RIBBON	4 1/4

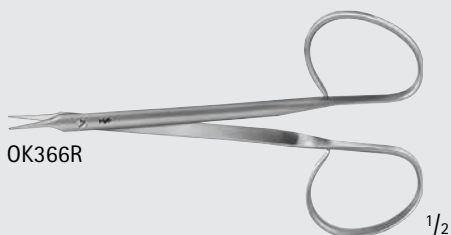

STEVENS Tenotomy Scissors, Delicate

Catalog Number	Tip	Blade	Handle	Length (in.)
BC008R	S/S	STR	SQUARE	4 1/2
BC010R	B/B	STR	SQUARE	4 1/2
BC009R	S/S	CVD	SQUARE	4 1/2
BC011R	B/B	CVD	SQUARE	4 1/2

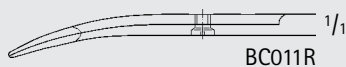
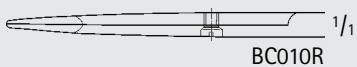
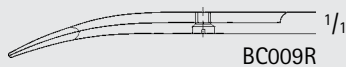
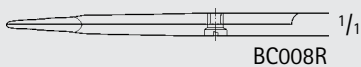
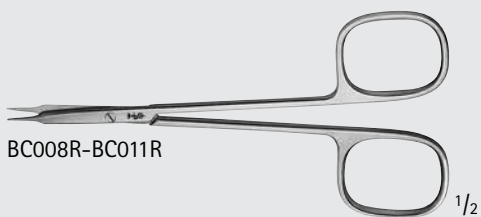

ENT
NASAL



BC170R-MA467R



BC170R

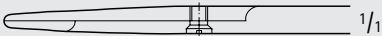

BC172R

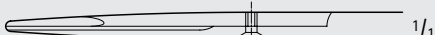

BC194R



MA467R



BC171R-MA466R



BC171R

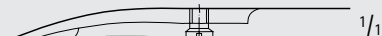

BC173R

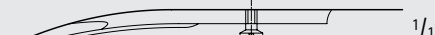

BC195R

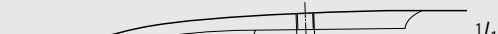

MA466R

STEVENS Tenotomy Scissors

Catalog Number	Tip	Blade	Handle	Length (in.)
BC170R	S/S	STR	ROUND	4 1/4
BC172R	B/B	STR	ROUND	4 1/4
BC194R	B/B	STR	ROUND	5
MA467R	B/B	STR	ROUND	5 3/4
BC171R	S/S	CVD	ROUND	4 1/4
BC173R	B/B	CVD	ROUND	4 1/4
BC195R	B/B	CVD	ROUND	5
MA466R	B/B	CVD	ROUND	5 3/4



ENT
NASAL

INCHES

ENT-NASAL

Scissors

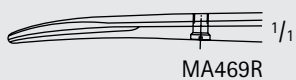
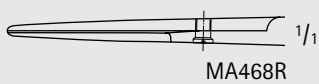
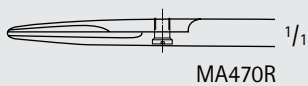

STEVENS Tenotomy Scissors

Catalog Number	Tip	Blade	Handle	Weight	Length (in.)
MA470R	B/B	STR	RIBBON	LIGHT	3 3/4
MA468R	B/B	STR	RIBBON	HEAVY	3 7/8
MA469R	B/B	CVD	RIBBON	HEAVY	3 3/4

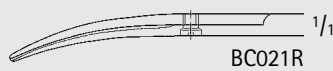
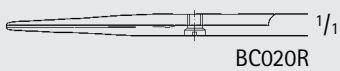
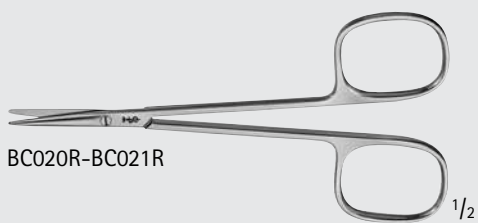

Strabismus Scissors, Delicate

Catalog Number	Tip	Blade	Handle	Length (in.)
BC020R	B/B	STR	SQUARE	4 1/2
BC021R	B/B	CVD	SQUARE	4 1/2

ENT
NASAL

MILLIMETERS

DUROTIP Tungsten Carbide Scissors

- Excellent cutting accuracy
- Long working life
- Gold-plated rings

DUROTIP TC FOMON Dorsal Scissors

Catalog Number	Tip	Blade Angle	Length (in.)
MB540R	B/B	30°	5 1/4

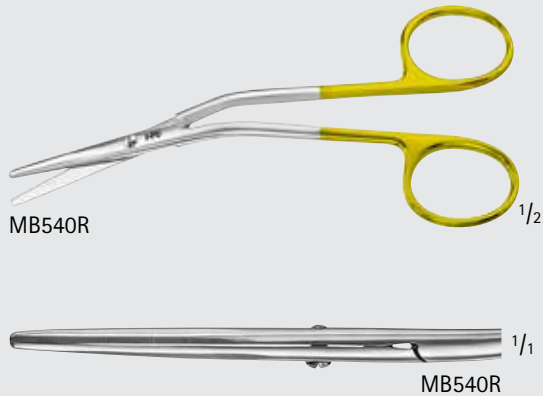

DUROTIP TC Iris Scissors, Delicate

Catalog Number	Tip	Blade	Length (in.)
BC210R	S/S	STR	4 1/4
BC211R	S/S	CVD	4 1/4

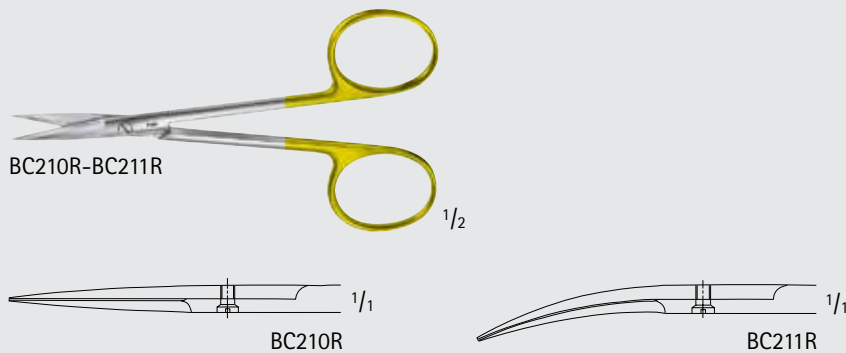

Wavecut

Wavecut scissors have one serrated cutting edge to prevent tissue from slipping.

The W after the catalog number indicates the scissors are the wavecut style, e.g. BC211W.

DUROTIP TC Iris Scissors, Wavecut

Catalog Number	Tip	Blade	Length (in.)
BC211W	S/S	CVD	4 1/4

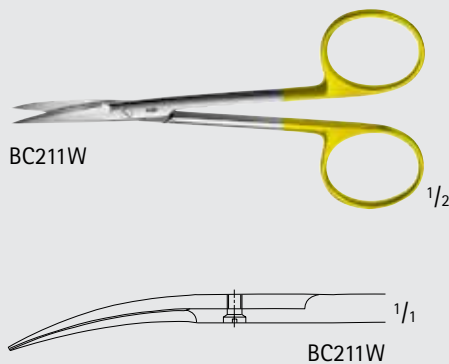

ENT-NASAL

DUROTIP™ TC Scissors

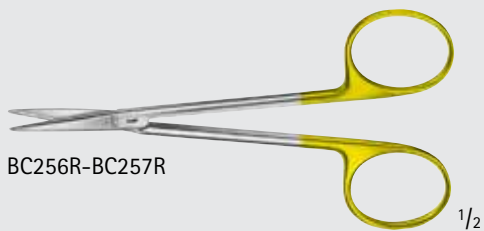

BC256R-BC257R

1/2

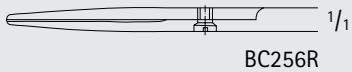

BC256R

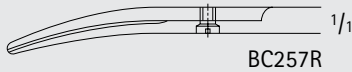

BC257R

DUROTIP TC Strabismus Scissors, Delicate

Catalog Number	Tip	Blade	Length (in.)
BC256R	B/B	STR	4 1/2
BC257R	B/B	CVD	4 1/2

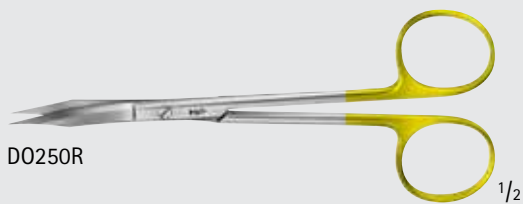

D0250R

1/2

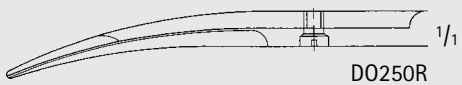

D0250R

DUROTIP TC GOLDMAN-FOX Tenotomy Scissors, Delicate

Catalog Number	Tip	Blade	Length (in.)
D0250R	S/S	CVD, 1/SERR	5 1/8

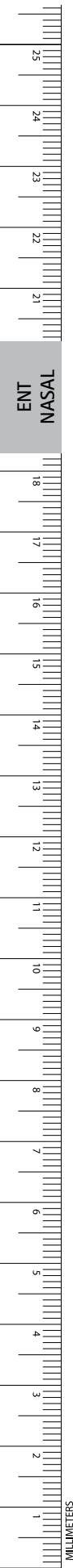

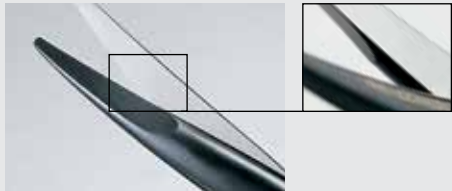

Microtome Edge

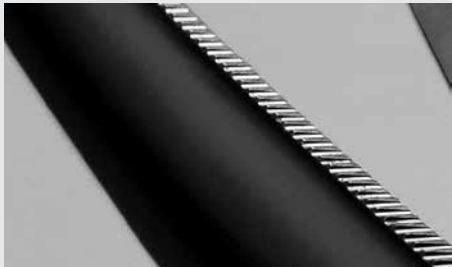

Wavecut

Noir Supreme Cut Scissors

- **Noir**
The combination of the renowned Aesculap Tungsten Carbide technology with the Aesculap Noir coating results in an extremely high surface hardness and therefore high wear resistance in daily hospital use.
- **Microtome edge**
The extremely sharp cutting edge of the scissors blade facilitates gentle cutting of tissue with minimal use of force.
- **Wavecut** helps prevent tissue from slipping out during the cutting process.
- The WB after the catalog number indicates the Noir scissors are the wavecut style, e.g. BC211WB.

For more information about Noir Supreme Cut Scissors see our brochure number DOC637.

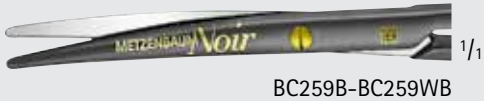

Noir Baby METZENBAUM Dissecting Scissors

Catalog Number	Tip	Blade	Length (in.)
BC259B	B/B	CVD	5 3/4
BC259WB	B/B	CVD	5 3/4



Noir Strabismus Dissecting Scissors

Catalog Number	Tip	Blade	Length (in.)
BC257B	B/B	CVD	4 1/2
BC257WB	B/B	CVD	4 1/2

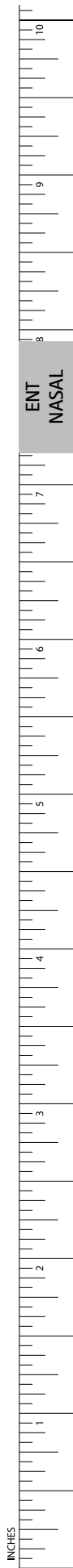

ENT-NASAL

SuperCut Scissors

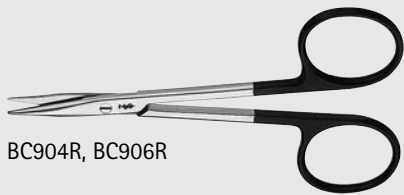

BC904R, BC906R

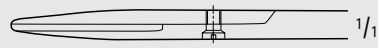

BC904R

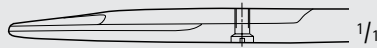

BC906R

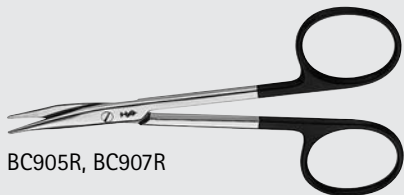

BC905R, BC907R

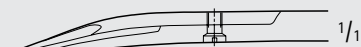

BC905R

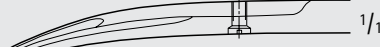

BC907R

STEVENS SuperCut Scissors

Catalog Number	Tip	Tip Size (mm)	Blade	Length (in.)
BC904R	B/B	12	STR	4 1/8
BC906R	B/B	13	STR	4 1/4
BC905R	B/B	12	CVD	4 1/8
BC907R	B/B	13	CVD	4 1/4



BC939R



BC939R

FOMON SuperCut Scissors

Catalog Number	Tip	Blade	Length (in.)
BC939R	B/B	CVD	4 1/2

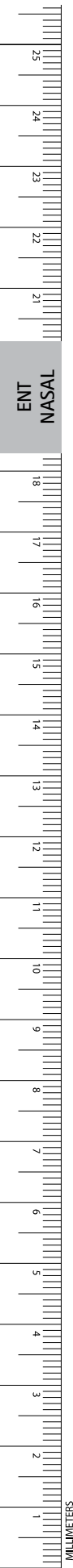

SF812R



Septum Needle W/ Luer Lock, Attachment

Catalog Number	Tip Size (mm)	Length (in.)
SF812R	DIAM. 0.8	3 1/2

MA553R, MA551R, MA552R

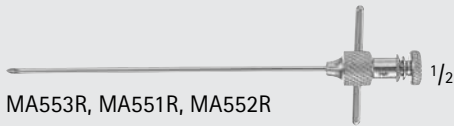

Antrum Trocar Needle

Catalog Number	Tip	Size	Length (in.)
MA553R	BEVELED STYLET	14 GA	4 1/4
MA551R	BEVELED STYLET	16 GA	4 1/4
MA552R	BEVELED STYLET	18 GA	4 1/4

MA553R, MA551R, MA552R



MA601R

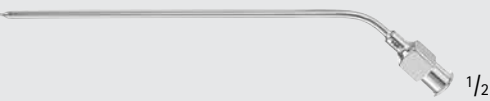

Septum Needle

Catalog Number	Tip	Size	Length (in.)
MA601R	ANG	22	5 3/8

MA554R



COAKLEY Antrum Trocar, with Irrigation Extension

Catalog Number	Length (in.)
MA554R	6 1/4

MA554R



ENT-NASAL

Trocars and Needles



Sinoscopy Trocar and Cannula

Catalog Number	Tip Size (mm)	Length (in.)
MA597R	4	6 1/2
MA598R	5	6 1/2



OCHSNER Trocar

Catalog Number	Tip Size (FR)	Length (in.)
MG100R	10	6
MG101R	12	6
MG102R	14	6
MG103R	16	6
MG104R	18	6
MG105R	20	6
MG106R	22	6
MG107R	24	6
MG108R	26	6
MG109R	27	6
MG110R	28	6

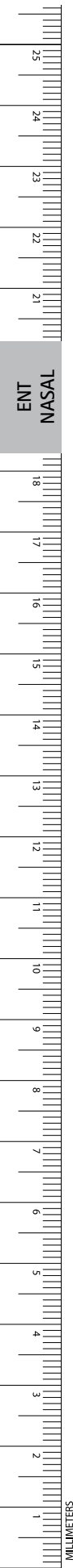

BROWN Needle Holder, Heavy

Catalog Number	Tip Size (mm)	Jaw	Length (in.)
MA362R	13	SERR	5 1/4

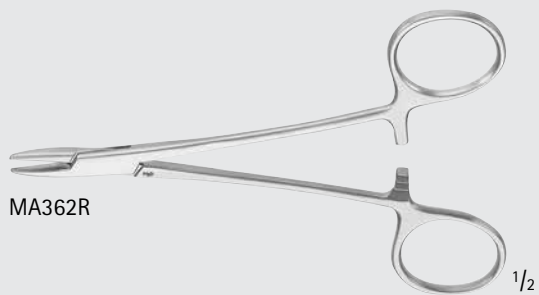

MA362R

1/2



MA362R

1/1

SOFFERMAN Needle Holder

Catalog Number	Tip Size (mm)	Jaw	Working Length (in.)
MA627R	5	STR, SERR	3 5/8

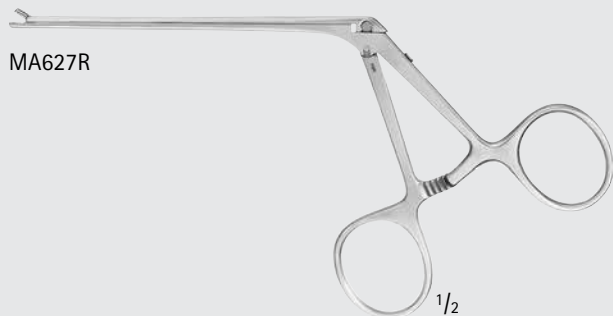

MA627R

1/2



MA627R

1/1

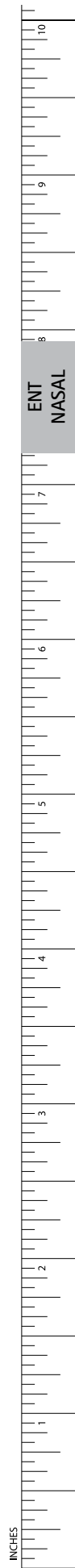

INCHES

ENT-NASAL

Forceps- Tissue/Dressing/Sponge



MA537R

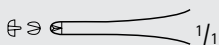

MA537R

CALLISON-ADSON Tissue Forceps, W/ Platform

Catalog Number	Teeth	Length (in.)
MA537R	1 x 2	5



MA070R



BD879R-BD878R

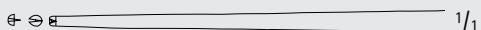

BD879R



BD878R



MA331R



MA331R



MA070R

LUCAE Bayonet Forceps

Catalog Number	Tip	Teeth	Length (in.)
BD879R	SMOOTH	1 x 2	5 1/2
BD878R	SERR	-	5 1/2
MA331R	SERR	-	6 3/8
MA070R	DEL, SERR	-	5 3/4



BD880R, MB236

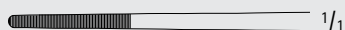

BD880R



MB236

JANSEN Bayonet Forceps

Catalog Number	Tip	Length (in.)
BD880R	SERR	6 1/4
MB236	SERR	6 1/2

ENT
NASAL

ENT-NASAL

Forceps- Tissue/Dressing/Sponge

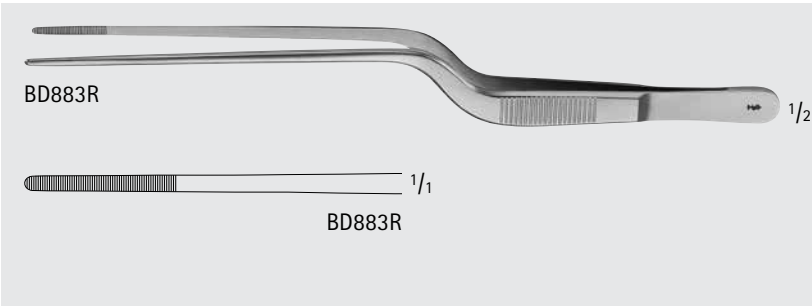

GRUENWALD Bayonet Forceps

Catalog Number	Tip	Length (in.)
BD883R	SERR	7 7/8

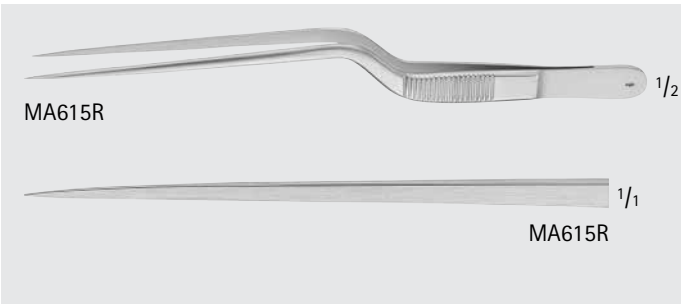

JACOBSON Forceps

Catalog Number	Tip	Length (in.)
MA615R	SMOOTH, SHARP	6 1/4

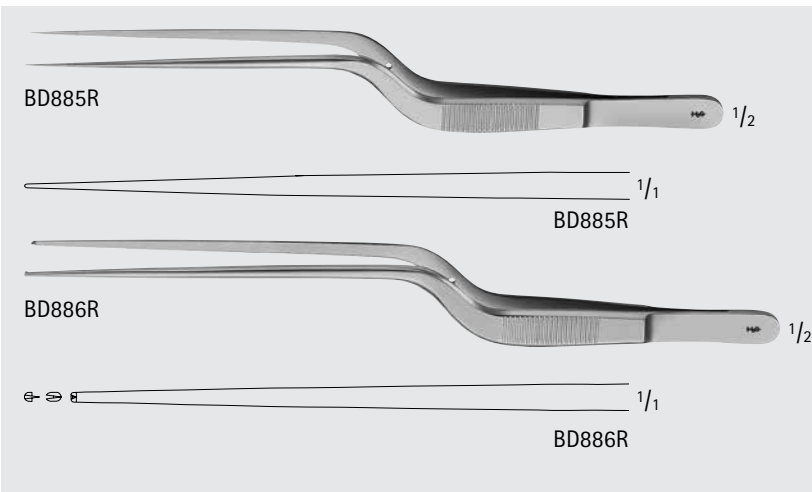

Bayonet Forceps

Catalog Number	Tip	Teeth	Length (in.)
BD885R	SMOOTH	-	7 1/4
BD886R	SMOOTH	1 x 2	7 7/8

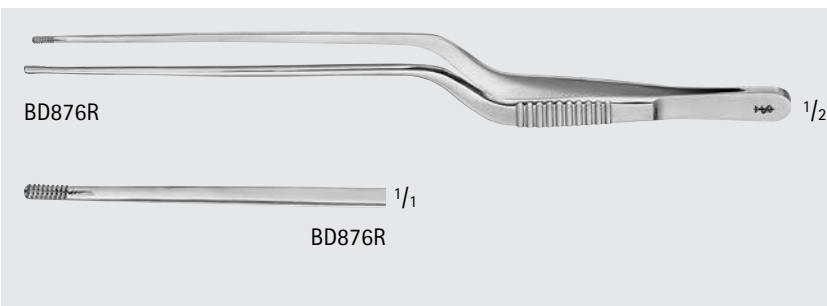

BROWN-BAHNSON Bayonet Forceps

Catalog Number	Tip	Length (in.)
BD876R	SERR	6 1/8

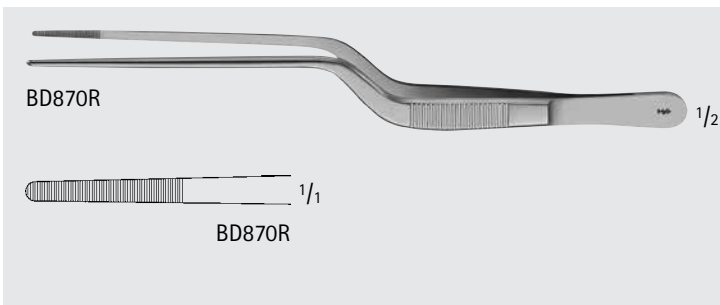

ADSON Bayonet Forceps

Catalog Number	Tip	Length (in.)
BD870R	SERR	6 7/8



ENT
NASAL

INCHES

ENT-NASAL

Forceps- Tissue/Dressing/Sponge



BD904R

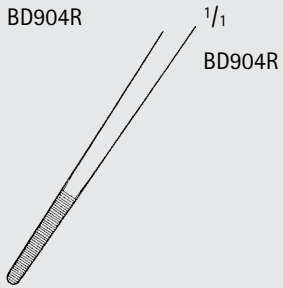

BD904R

WILDE Forceps

Catalog Number	Tip	Length (in.)
BD904R	ANG/SERR	4 1/2



BD900R-BD902R

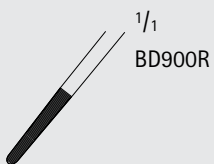

BD900R

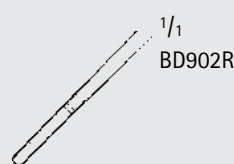

BD902R

TROELTSCH Bayonet Forceps

Catalog Number	Tip	Length (in.)
BD900R	ANG/SERR	4
BD902R	ANG/SERR	4 1/2
BD910R	ANG/SERR	5 1/2
BD911R	ANG/SERR	6 3/4



BD910R-BD911R

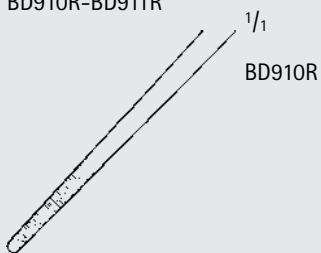

BD910R

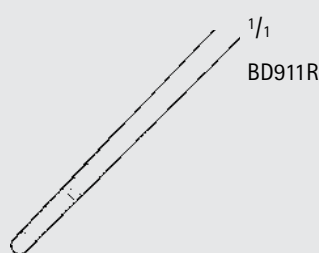

BD911R

ENT
NASAL

MILLIMETERS

ENT-NASAL

Forceps- Tissue/Dressing/Sponge

HARTMANN Alligator Forceps

Catalog Number	Tip	Length (in.)
OK245R	ANG/SERR	7 1/2

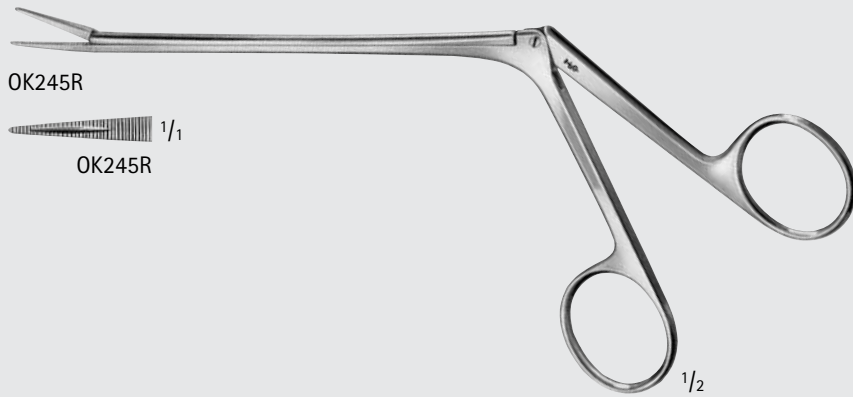

HARTMANN Nasal Dressing Forceps

Catalog Number	Length (in.)
OK242R	6 7/8
MA329R	7
OK243R	7 7/8
MA330R	8 1/2

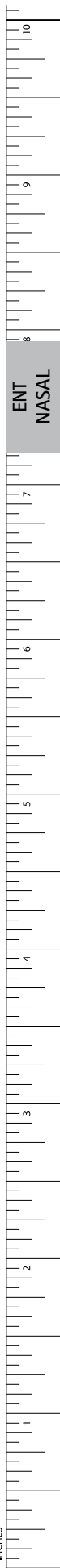
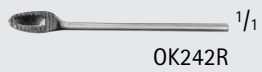

ENT-NASAL

Forceps- Tissue/Dressing/Sponge

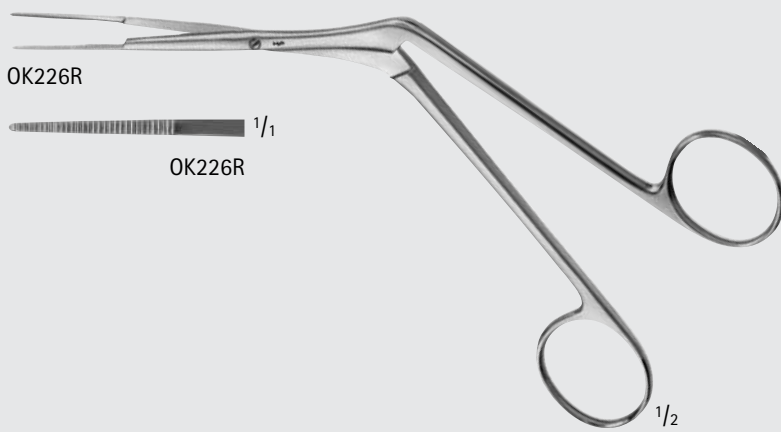

WEST Nasal Dressing Forceps

Catalog Number	Tip	Length (in.)
OK226R	SERR	7 7/8



OL010R

COTTLE Columella Clamp, W/ Fixation Screw

Catalog Number	Length (in.)
OL010R	4

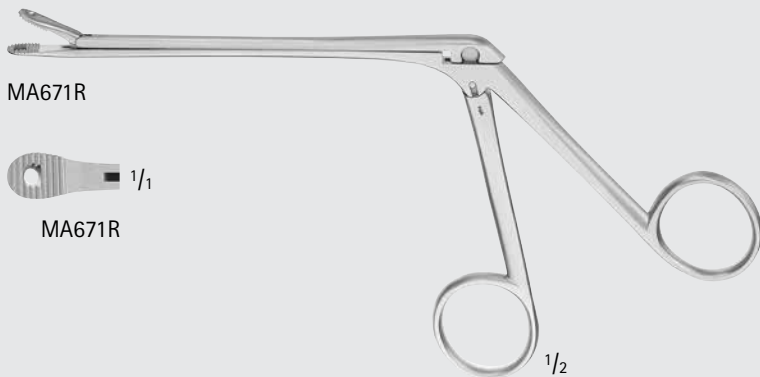

FERRIS-SMITH Fragment Forceps

Catalog Number	Tip Size (mm)	Working Length (in.)	Length (in.)
MA671R	8.2 x 6	4 1/4	7 7/8

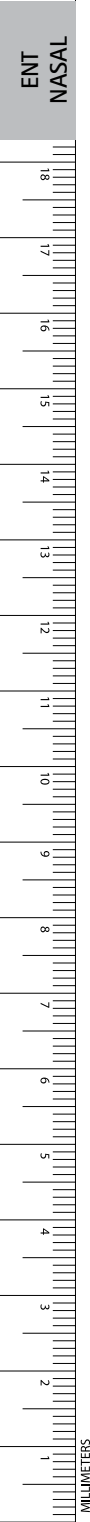

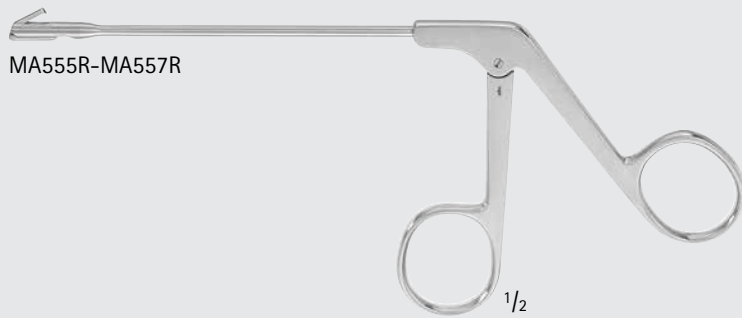

MA555R-MA557R

OSTRUM Antrum Backbiting Punch Forceps

Catalog Number	Jaw Size (mm)	Jaw	Working Length (in.)	Length (in.)
MA555R	3 x 7	STR	4 1/4	7 3/4
MA556R	3 x 7	ANG-LEFT	4 1/4	7 3/4
MA557R	3 x 7	ANG-RIGHT	4 1/4	7 3/4



MA555R



MA556R



MA557R



OK440R-OK443R

BRUENINGS Septum Forceps

Catalog Number	Size	Length (in.)
OK440R	SMALL	7 1/2
OK441R	MEDIUM	7 1/2
OK442R	LARGE	7 1/2
OK443R	X-LARGE	7 1/2



OK440R



OK442R

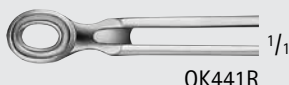

OK441R



OK443R

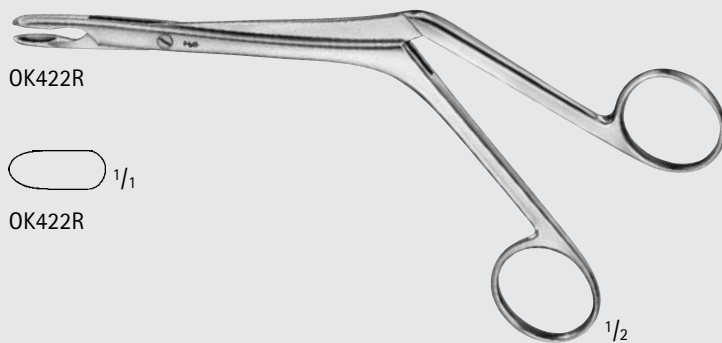

OK422R

HEYMANN-KNIGHT Septum Forceps

Catalog Number	Jaw	Length (in.)
OK422R	OVAL	7 1/2

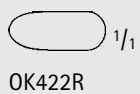

OK422R

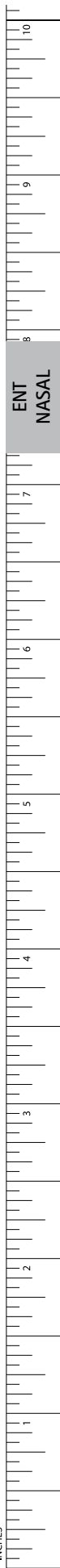

ENT-NASAL

Forceps- Nasal/Polyp/Bone Cutting

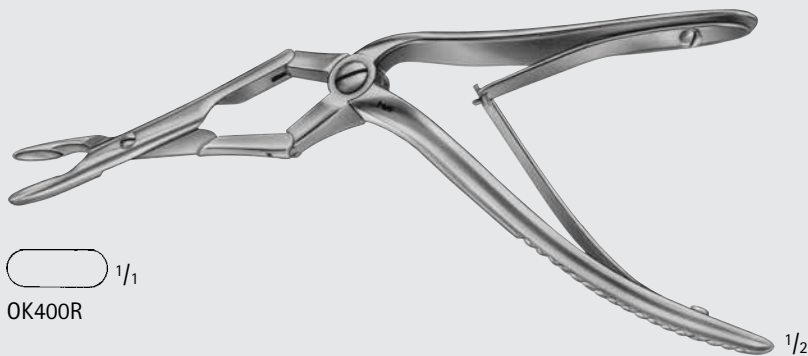

OK400R 1/1

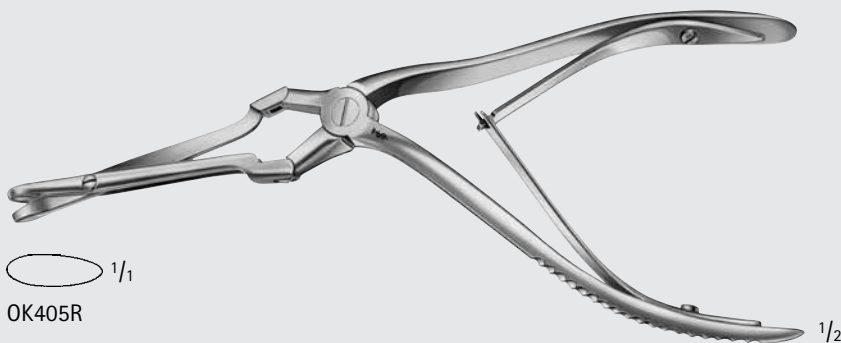

OK405R 1/1

JANSEN-MIDDLETON Septum Forceps

Catalog Number	Jaw	Length (in.)
OK400R	SPOON	7 7/8
OK405R	THRU-CUT	8 1/4

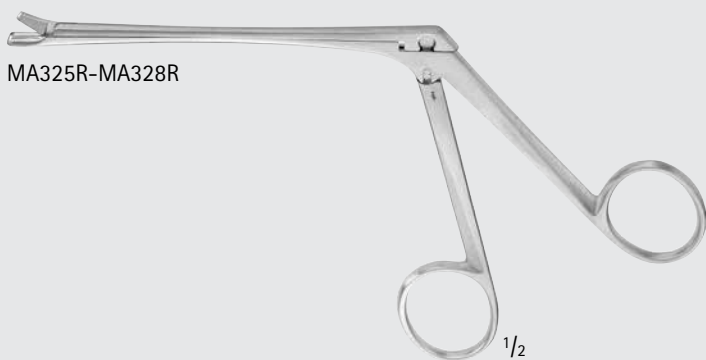

MA325R-MA328R



MA325R 1/1



MA327R 1/1



MA326R 1/1



MA328R 1/1

GRUENWALD Nasal Forceps

Catalog Number	Tip Size (mm)	Tip Size (#)	Working Length (in.)	Length (in.)
MA325R	2.5 x 9	1	4	7 1/4
MA326R	3 x 10	2	4	7 1/4
MA327R	3.5 x 11	3	4	7 1/4
MA328R	3.5 x 10	3	4	7 1/4







OK612R-OK613R

GRUENWALD-HENKE Nasal Thru-Cut Rongeur

Catalog Number	Jaw	Working Length (in.)
OK612R	SMALL	4 3/4
OK613R	LARGE	4 3/4



 1/1
OK612R

 1/1
OK613R

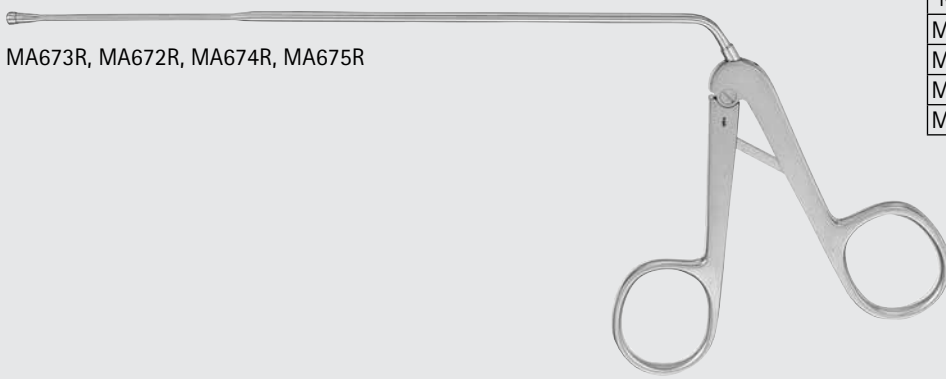



MA673R, MA672R, MA674R, MA675R

STAMMBERGER Circular Punch Forceps

Catalog Number	Tip	Tip Size (mm)	Working Length (in.)	Length (in.)
MA673R	STR	3.5	7 1/2	9 3/4
MA672R	STR	4.5	7 1/2	9 3/4
MA674R	70° UP	3.5	7 1/4	9 5/8
MA675R	70° UP	4.5	7 1/4	10 1/4

 1/1
MA673R

 1/1
MA674R

 1/1
MA672R

 1/1
MA675R

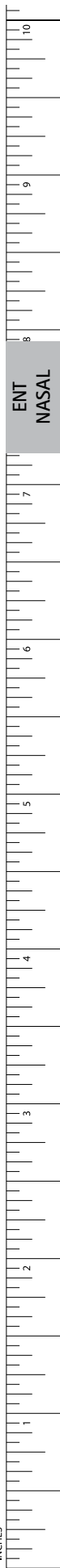

INCHES

ENT-NASAL

Forceps- Nasal/Polyp/Bone Cutting

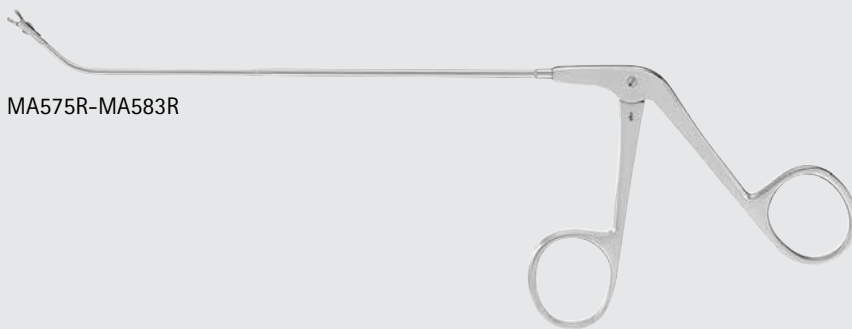
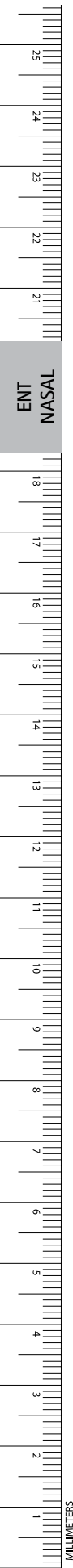

MA575R-MA583R



MA575R, MA577R $\frac{1}{1}$



MA576R, MA580R $\frac{1}{1}$

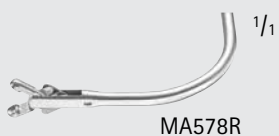

MA578R $\frac{1}{1}$



MA579R $\frac{1}{1}$



MA582R $\frac{1}{1}$



MA581R, MA583R $\frac{1}{1}$

Giraffe Frontal Sinus Forceps

Catalog Number	Jaw	Cup Size (mm)	Working Length (in.)	Length (in.)
MA575R	ANG 45° VERTICAL CUTTING	2	5 1/2	8 7/8
MA576R	ANG 45° HORIZONTAL CUTTING	2	5 1/2	8 7/8
MA577R	ANG 90° VERTICAL CUTTING	2	5 1/8	8 3/8
MA578R	ANG 90° HORIZONTAL CUTTING	2	5 1/8	8 3/8
MA579R	ANG 45° VERTICAL CUTTING	3	5 1/2	8 7/8
MA581R	ANG 70° VERTICAL CUTTING DOUBLE ACTION	3	5 1/8	8 1/4
MA580R	ANG 90° HORIZONTAL CUTTING	3	5 1/2	8 7/8
MA582R	ANG 70° HORIZONTAL CUTTING DOUBLE ACTION	4	5 1/8	8 1/4
MA583R	ANG 100° HORIZONTAL CUTTING DOUBLE ACTION	4	4 5/8	8 1/4

ENT-NASAL

Forceps- Nasal/Polyp/Bone Cutting

Giraffe Thru-Cut Sinus Forceps

Catalog Number	Jaw	Cup Size (mm)	Working Length (in.)
MA584R	ANG 70° VERTICAL CUTTING	3 x 6	4 3/4

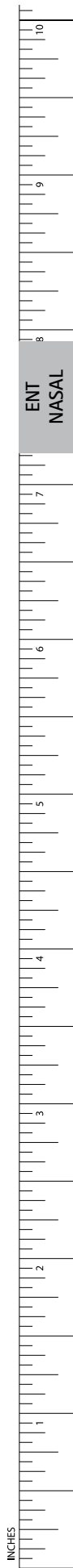
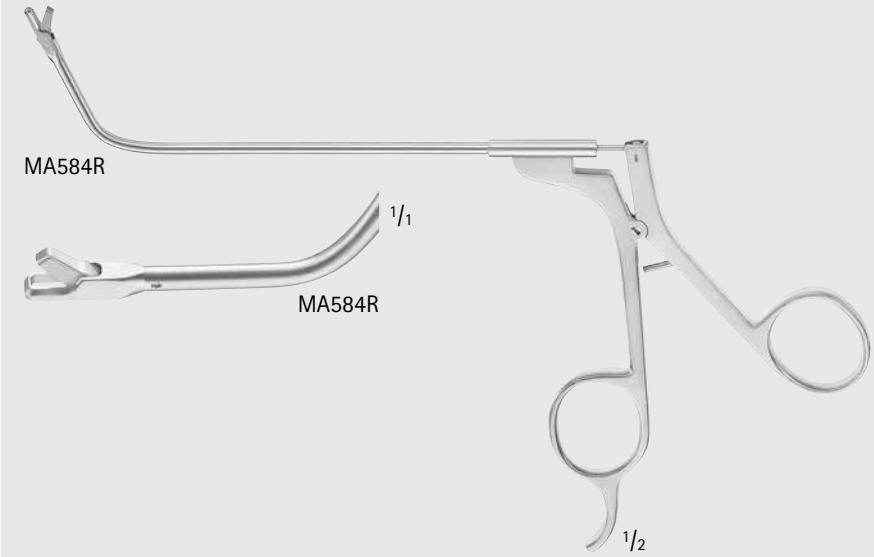

ENT-NASAL

Forceps- Nasal/Polyp/Bone Cutting

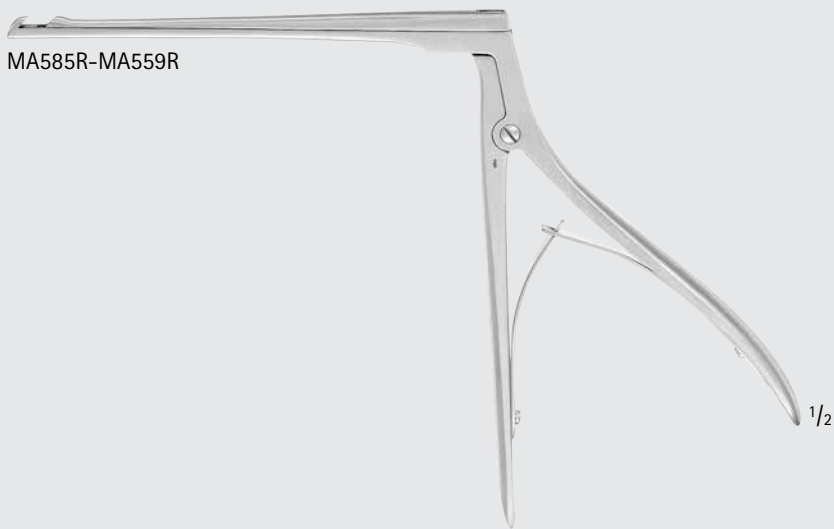

MA585R-MA559R



MA585R



MA559R

Antrum Punch Forceps

Catalog Number	Jaw	Tip	Cup Size (mm)	Working Length (in.)	Length (in.)
MA585R	ANG 45° BACKWARD 3 MM	3	4 x 5	5 1/2	8 1/4
MA559R	45° FORWARD 3 MM	3	4 x 5	5 1/2	8 1/4



MA415R



MA415R

MCKENTY Sphenoid Punch Forceps, Rotatable

Catalog Number	Jaw	Working Length (in.)	Length (in.)
MA415R	1.5 x 4	5 3/4	7

ENT-NASAL

Forceps- Nasal/Polyp/Bone Cutting



KERRISON Nasal Rongeur

Catalog Number	Jaw Size (mm)	Jaw	Working Length (in.)
OK711R	4.0	90° UP	3 1/4
OK712R	5.0	90° UP	3 3/8

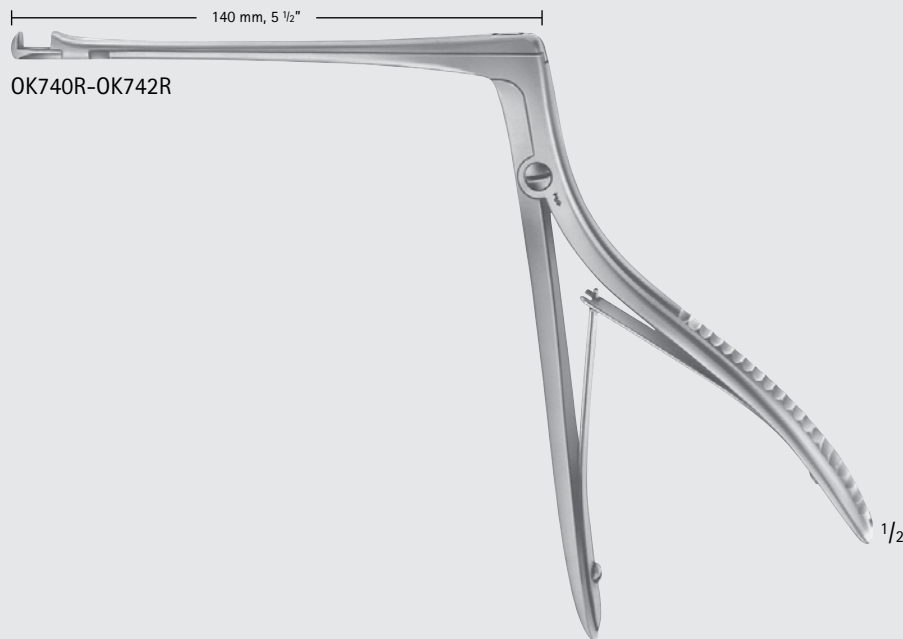
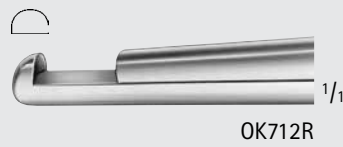
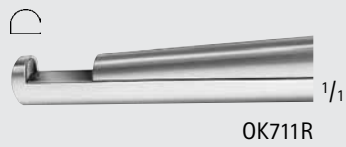

HAJEK-KOFLER Punch

Catalog Number	Jaw Size (mm)	Jaw	Working Length (in.)
OK740R	3.3	90° UP	5 1/2
OK741R	3.3	90° DOWN	5 1/2
OK742R	4.0	90° UP	5 1/2

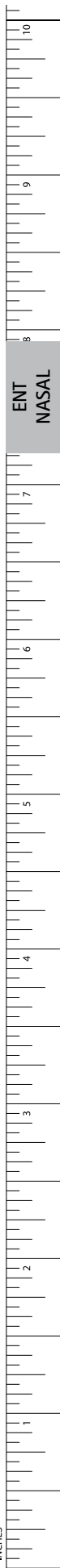
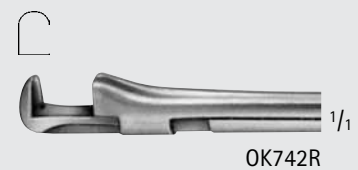
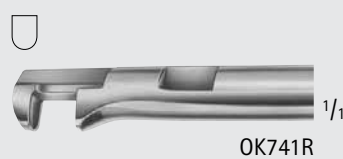

ENT-NASAL

Forceps- Nasal/Polyp/Bone Cutting



HAJEK-KOFLER Rotatable Punch, (continued)

Catalog Number	Jaw Size (mm)	Jaw	Working Length (in.)
OK745R	4.0	90° UP	6 3/4

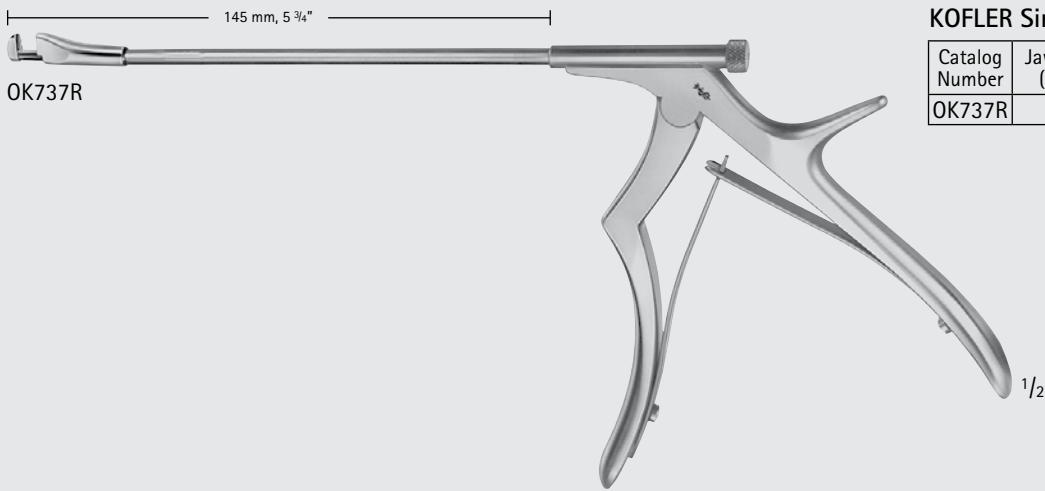
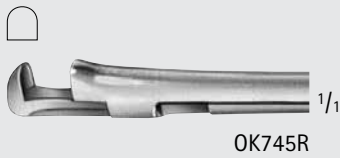

KOFLER Sinus Punch, Rotatable

Catalog Number	Jaw Size (mm)	Jaw	Working Length (in.)
OK737R	3.0	90° UP	5 3/4

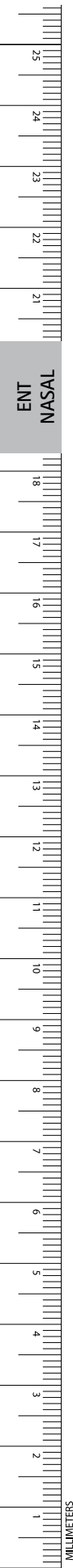



MA340R-MA343R, OK525R-OK526R

TAKAHASHI Nasal Forceps

Catalog Number	Jaw Size (mm)	Jaw	Working Length (in.)
MA342R	2.5	STR	4 3/8
OK525R	3.0	STR	4 3/4
MA340R	3.0	STR	6 3/8
MA343R	4.0	STR	4 3/8
MA341R	4.0	STR	6 3/8
OK526R	3.0	45° UP	4 3/4

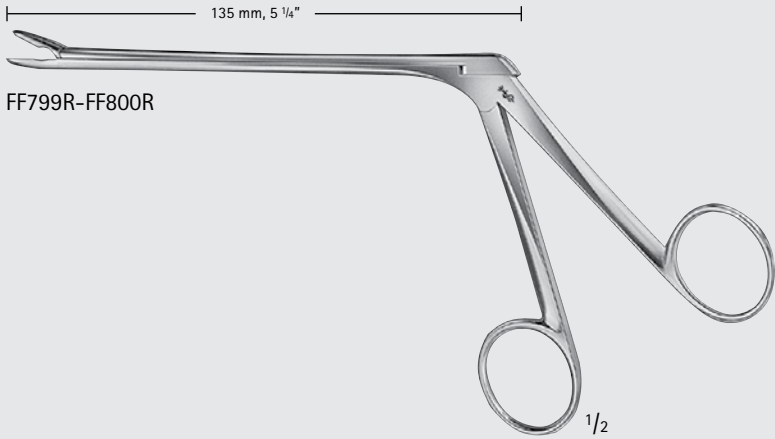
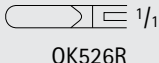
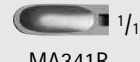
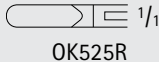
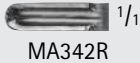

FF799R-FF800R

LOVE-GRUENWALD Rongeur

Catalog Number	Jaw Size (mm)	Jaw	Working Length (in.)
FF799R	2 x 10	STR	5 1/4
FF800R	3 x 10	STR	5 1/4

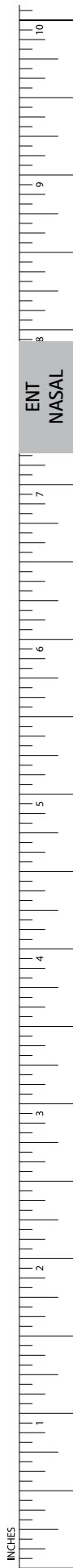
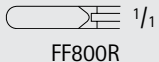
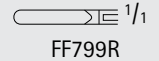

ENT-NASAL

Forceps- Nasal/Polyp/Bone Cutting

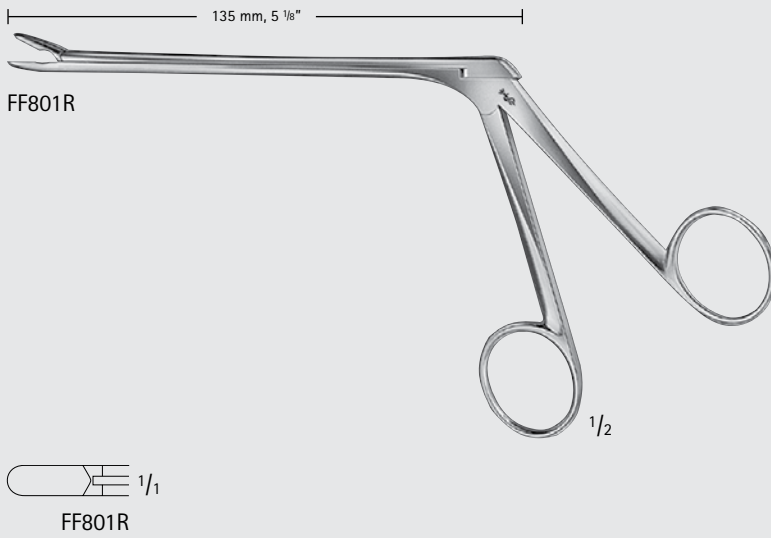

SPURLING Rongeur

Catalog Number	Jaw Size (mm)	Jaw	Working Length (in.)
FF801R	4 x 10	STR	5 1/8

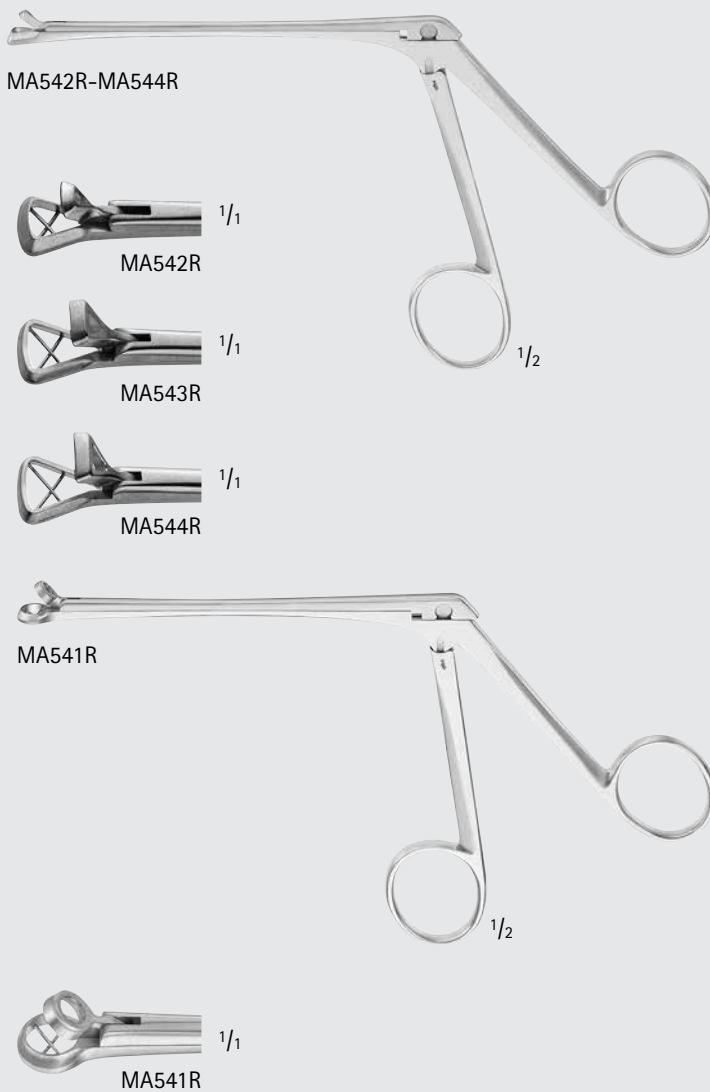

MELTZER Adenoid Punch Forceps

Catalog Number	Tip Size (mm)	Size (#)	Jaw	Working Length (in.)	Length (in.)
MA542R	5 MM BOTTOM BASKET, 4 MM UPPER JAW	0	TRIANGULAR	4 1/2	7 1/4
MA543R	7 MM BOTTOM BASKET, 3 MM UPPER JAW	1	TRIANGULAR	4 1/2	7 1/4
MA544R	9 MM BOTTOM BASKET, 8 MM UPPER JAW	2	TRIANGULAR	4 1/2	7 1/4
MA541R	6 MM BOTTOM BASKET, 5 MM UPPER BITE	1	ROUND	4 1/2	7 1/4

ENT
NASAL

MILLIMETERS

Nasal Biopsy Forceps

Catalog Number	Cup Size (mm)	Tip	Working Length (in.)	Length (in.)
MA676R	2.5 x 4	STR	5	7
MA680R	2.5 x 5	70° UP	4	7
MA678R	2.5 x 6	70° UP	3 1/2	7 1/4

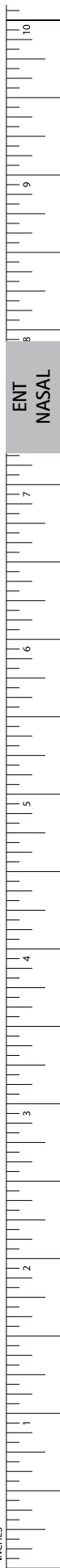
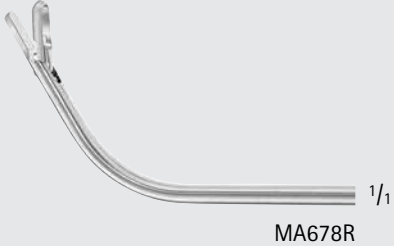
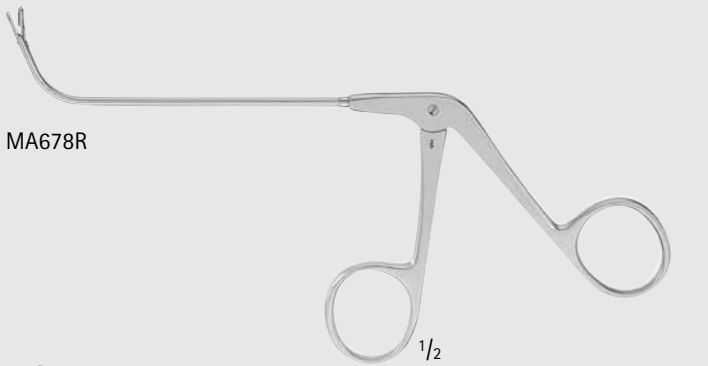
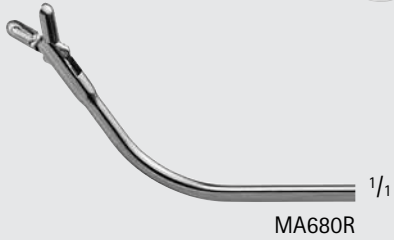
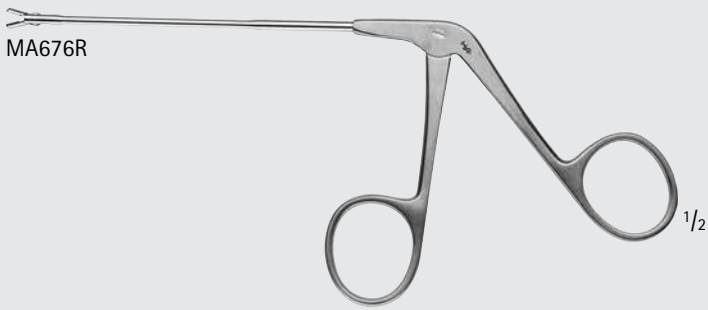

ENT-NASAL

Forceps- Nasal/Polyp/Bone Cutting

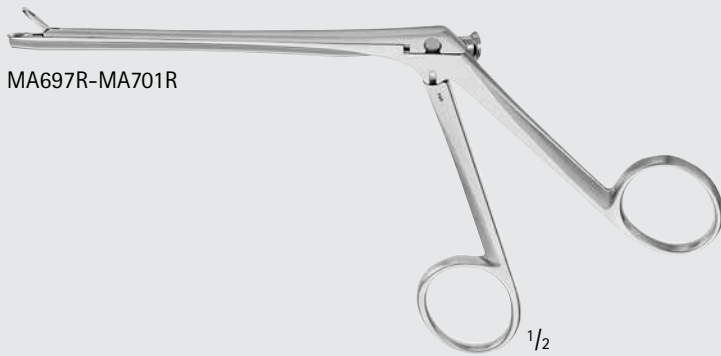

Nasal Suction Forceps

Catalog Number	Jaw Length (mm)	Tip	Tip Size (#)	Working Length (in.)	Length (in.)
MA697R	2.5	STR	00	4	7 1/4
MA699R	3.5	STR	0	4	7 1/4
MA701R	4.5	STR	1	4	7 1/4
MA698R	2.5	45° ANG-UP	00	4 3/4	7 1/4
MA700R	3.5	45° ANG-UP	0	4 1/2	7 3/4

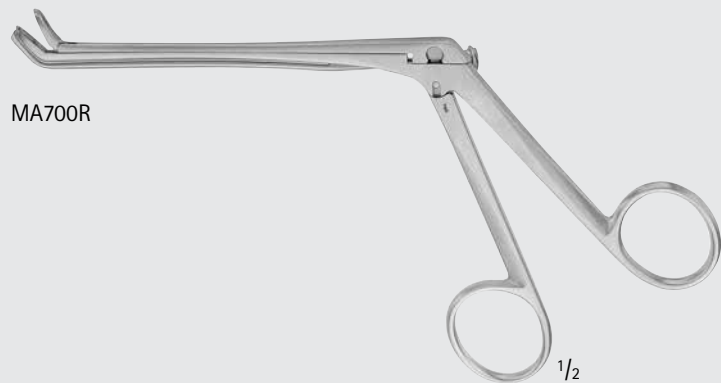

ENT
NASAL

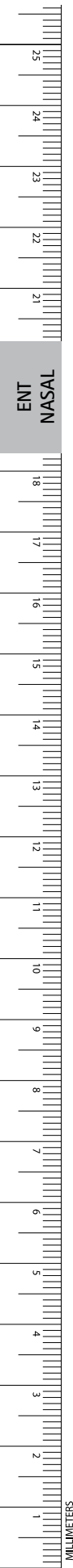

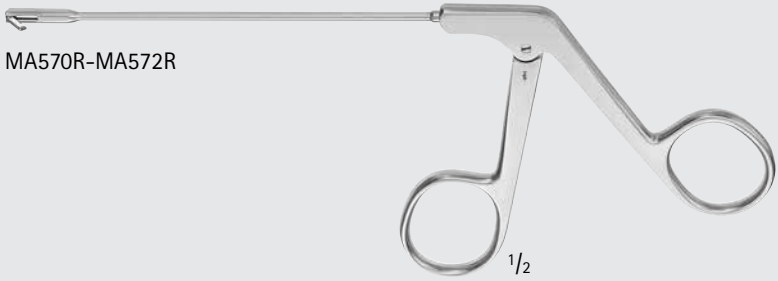

MA570R-MA572R



MA570R



MA571R



MA572R

Pediatric Ostrum Antrum Punch Forceps

Catalog Number	Jaw Size (mm)	Jaw	Working Length (in.)	Length (in.)
MA570R	1.5 x 4	STR BACK BITE	4 1/2	8
MA571R	1.5 x 4	RIGHT SIDE BITE	4 1/2	8
MA572R	1.5 x 4	LEFT SIDE BITE	4 1/2	8

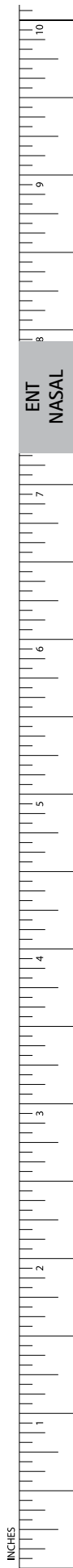

INCHES

ENT-NASAL

Forceps- Nasal/Polyp/Bone Cutting



MA563R-MA565R



MA563R



MA564R



MA565R

Ethmoid Forceps, Pediatric

Catalog Number	Jaw Size (mm)	Jaw	Working Length (in.)	Length (in.)
MA563R	3 x 5	STR	4	6 1/8
MA564R	3 x 5	ANG UP 45°	4	6 1/8
MA565R	3 x 5	ANG UP 90°	3 3/4	6 1/8

Rotating Ostrum Antrum Punch Forceps, Backbiting

Catalog Number	Jaw Size (mm)	Size	Jaw	Working Length (in.)	Length (in.)
MA574R	1.5 x 4	Pediatric	ROTATING 360°	4 1/4	8 1/4
MA573R	3 x 7	Adult	ROTATING 360°	4 1/4	8 1/4

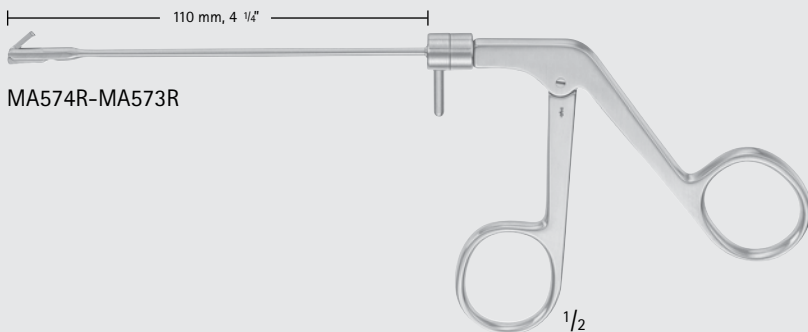

MA574R-MA573R



MA574R



MA573R

ENT
NASAL

MILLIMETERS

RONIS Adenoid Nasal Forceps

Catalog Number	Tip Size (mm)	Tip Size (#)	Jaw	Working Length (in.)	Length (in.)
MA545R	7 MM BASKET	1	TRIANGULAR	5 3/8	8 1/8
MA546R	8 MM BASKET	2	TRIANGULAR	5 3/8	8 1/8

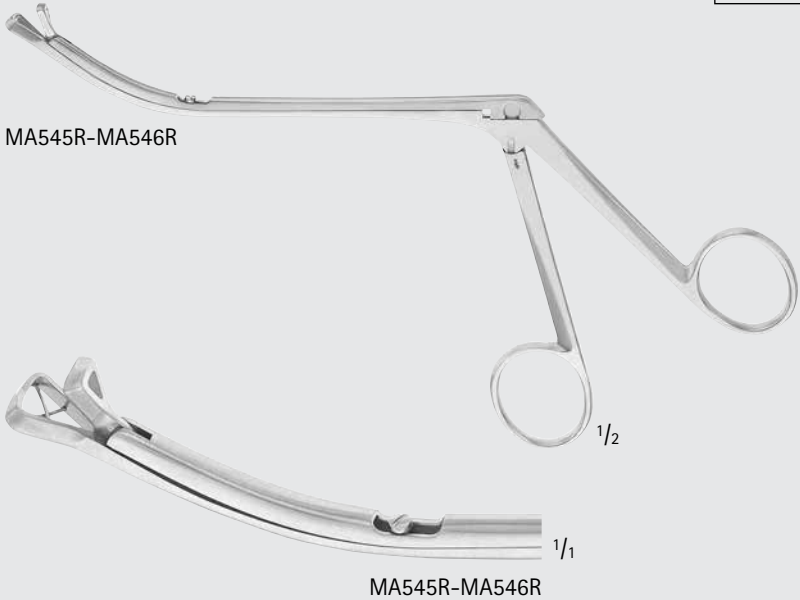

STAMMBERGER Sidecutting Antrum Punch Forceps

Catalog Number	Jaw	Length (in.)
MA568R	LEFT CUT	8 5/8
MA569R	RIGHT CUT	8 5/8

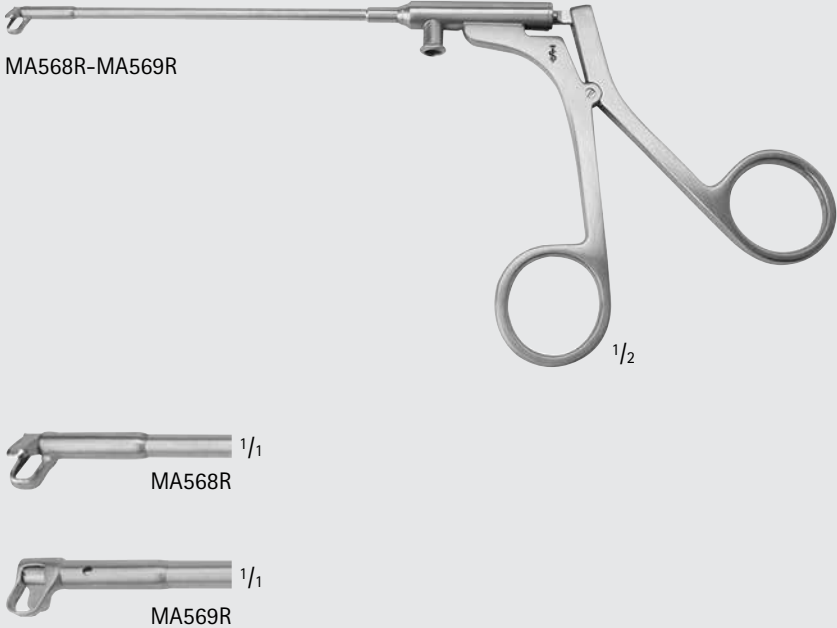

ENT-NASAL

Forceps- Nasal/Polyp/Bone Cutting

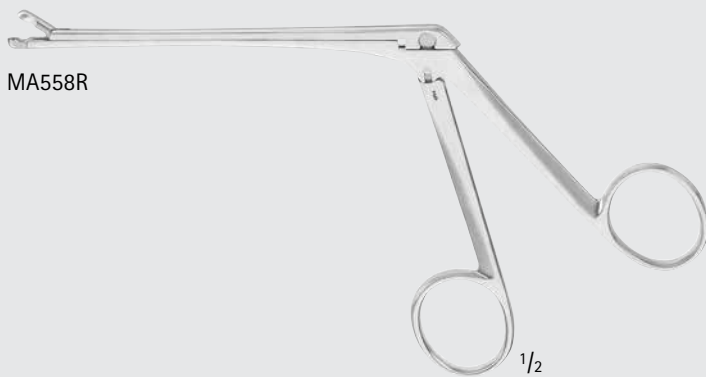

MA558R

Sinus Cup Forceps

Catalog Number	Cup Size (mm)	Working Length (in.)	Length (in.)
MA558R	3	4 1/2	7



MA558R



MA669R

COTTLE Biting Forceps

Catalog Number	Jaw Length (mm)	Jaw	Length (in.)
MA669R	30	ANG	7



MA669R

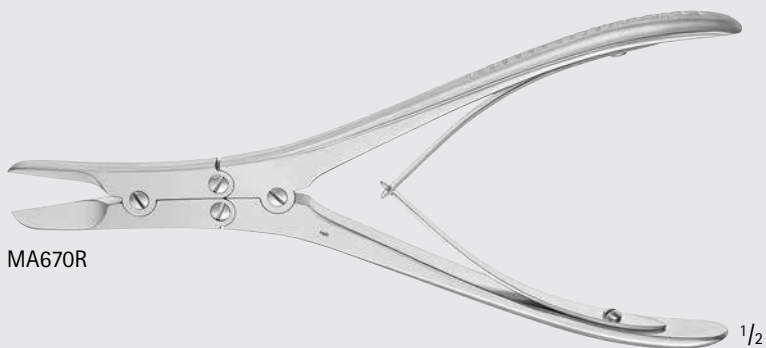

MA670R

ROWLAND Bone Cutting Forceps, Double Action

Catalog Number	Jaw Length (mm)	Length (in.)
MA670R	25	7 1/4

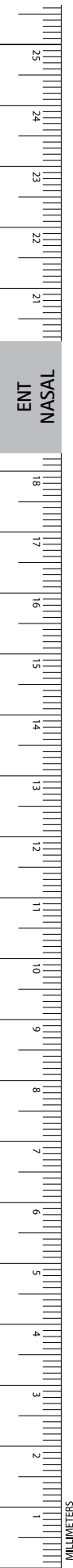

STAMM Bone Cutting Ronguer

Catalog Number	Length (in.)
F0604R	6



F0604R



F0604R



ENT-NASAL

Forceps- Nasal/Polyp/Bone Cutting

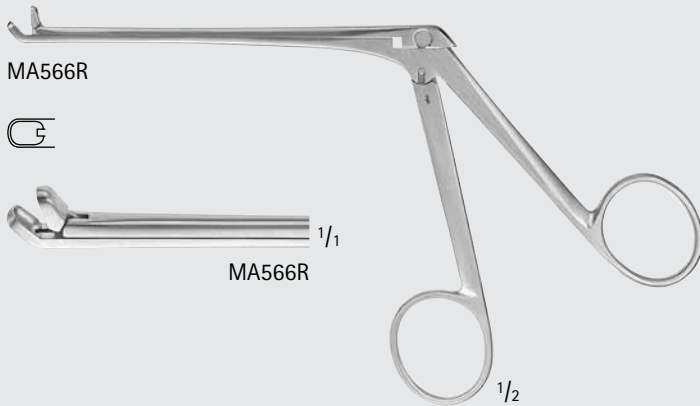

STUEMPEL-VOSS Nasal Forceps

Catalog Number	Cup (mm)	Tip	Working Length (in.)	Length (in.)
MA566R	3 x 5	ANG UP	4 1/4	6 7/8

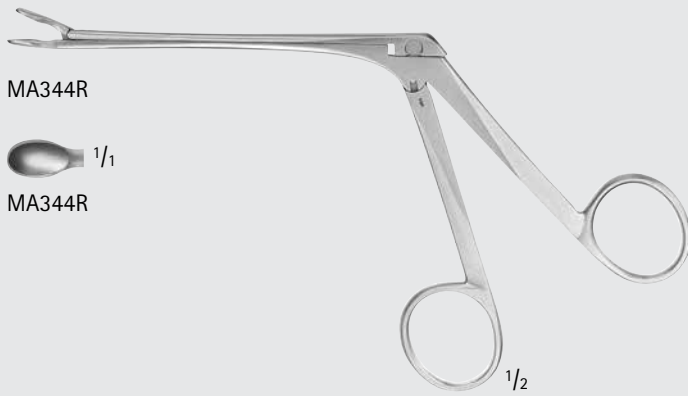

WEIL Nasal Forceps

Catalog Number	Cup (mm)	Tip	Working Length (in.)	Length (in.)
MA344R	5 x 8	STR	4	7 1/8
MA345R	5 x 8	ANG UP	4	7 1/8

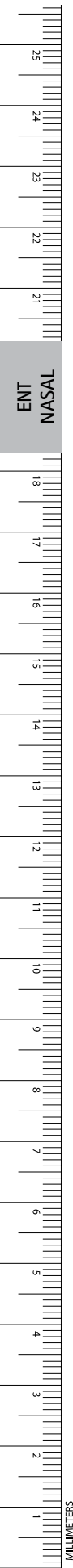
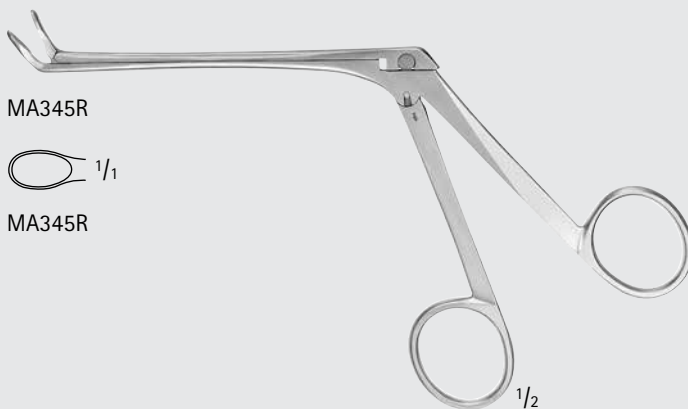

120 mm, 4 3/4"

OK505R-OK509R



OK505R 1/1

MA320R 1/1

OK506R 1/1

MA321R 1/1

OK507R 1/1

OK508R 1/1

MA322R 1/1

OK509R 1/1

110 mm, 4 1/4"

OK520R-OK522R

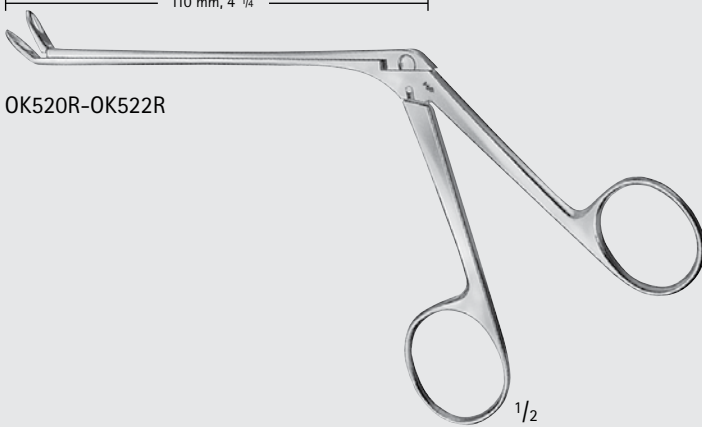

OK520R 1/1

MA323R 1/1

OK521R 1/1

OK522R 1/1

MA324R

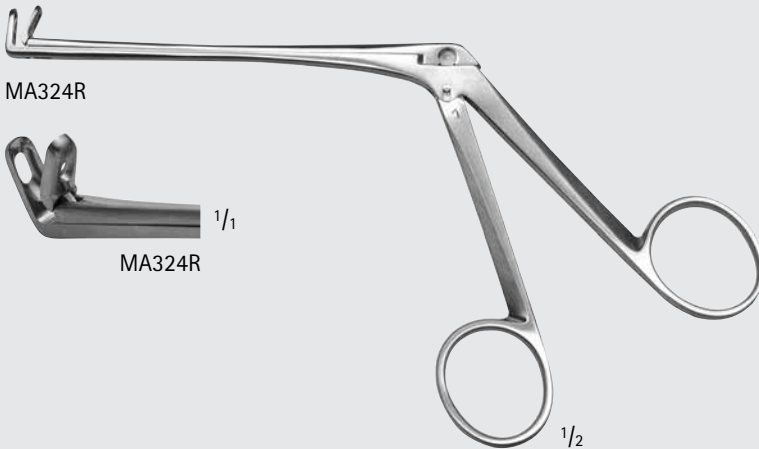

MA324R 1/1

WEIL-BLAKESLEY Nasal Forceps

Catalog Number	Jaw Size (mm)	Tip	Tip Size (#)	Working Length (in.)
OK505R	3.0	STR	0	4 3/4
MA320R	3.5	STR	0	4
OK506R	3.6	STR	0	4 3/4
MA321R	4	STR	1	4 1/2
OK507R	4.2	STR	1	4 3/4
OK508R	4.8	STR	2	4 3/4
MA322R	5	STR	2	4 1/2
OK509R	5.6	STR	3	4 3/4
OK520R	3.6	ANG 45° UP	0	4 1/2
MA323R	4	ANG 45° UP	1	4 1/8
OK521R	4.2	ANG 45° UP	1	4 1/2
OK522R	4.8	ANG 45° UP	2	4 1/2
MA324R	4	ANG 90° UP	1	4



INCHES

ENT-NASAL

Forceps- Nasal/Polyp/Bone Cutting



BLAKESLEY Thru-Cut Forceps

Catalog Number	Size	Jaw Size (mm)	Tip	Jaw Size (#)	Working Length (in.)	Length (in.)
MA694R	PEDIATRIC	2.5	STR	00	4 1/4	7
MA695R	PEDIATRIC	2.5	ANG	00	4 1/4	7
MA684R	-	3.5	STR	0	4 1/2	7 3/4
MA686R	-	2.5	ANG UP	00	4 3/8	7 1/4

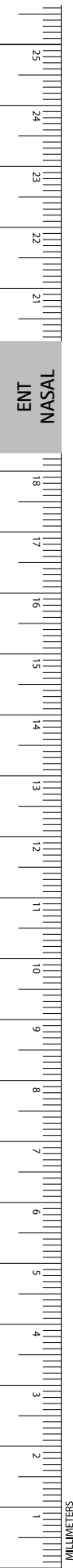
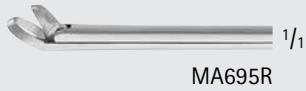
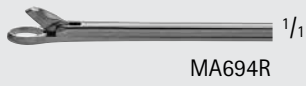

BLAKESLEY-WILDE Nasal Forceps

Catalog Number	Jaw Size (mm)	Tip	Working Length (in.)
OK544R	10 x 3.5	ANG 90° UP	4 1/4
OK545R	13.5 x 3.8	ANG 90° UP	4 1/4
OK546R	14.3 x 5	ANG 90° UP	4 1/4

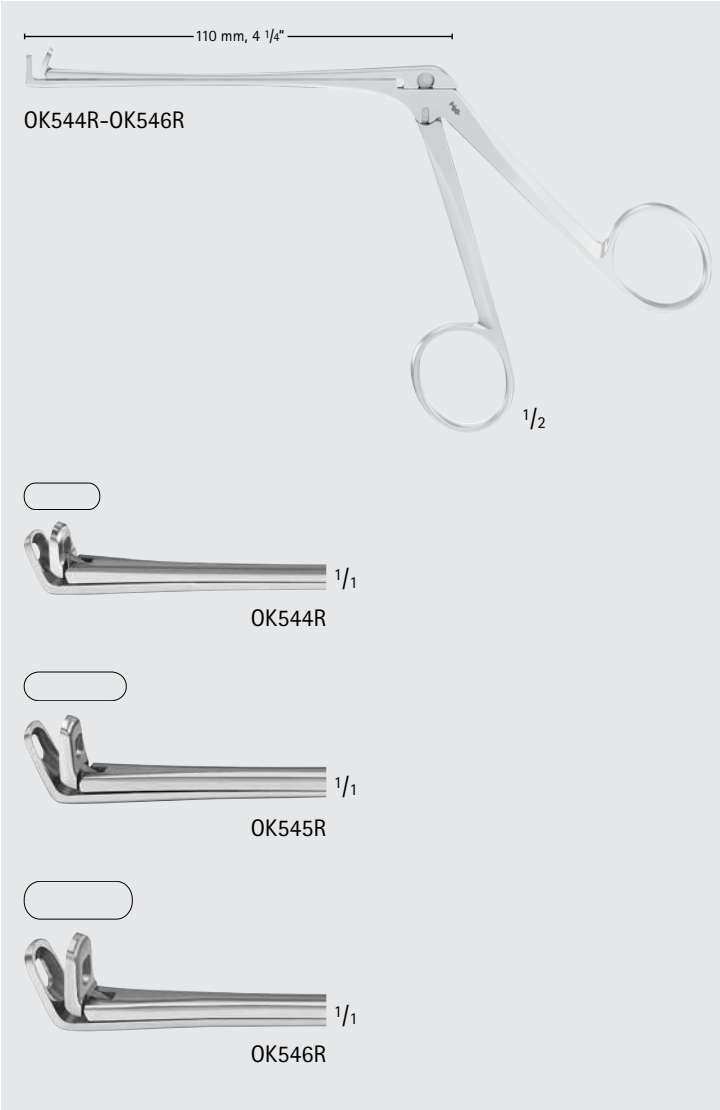

WILDE Ethmoid Nasal Forceps

Catalog Number	Jaw Size (mm)	Tip	Jaw Size (#)	Working Length (in.)
MA567R	3.5 x 12	ANG UP 45°	0	4 3/8

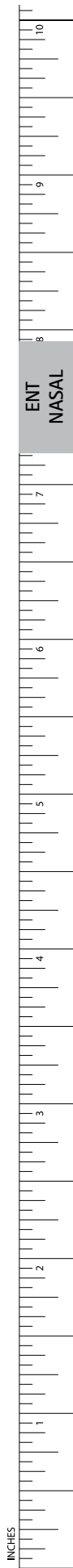
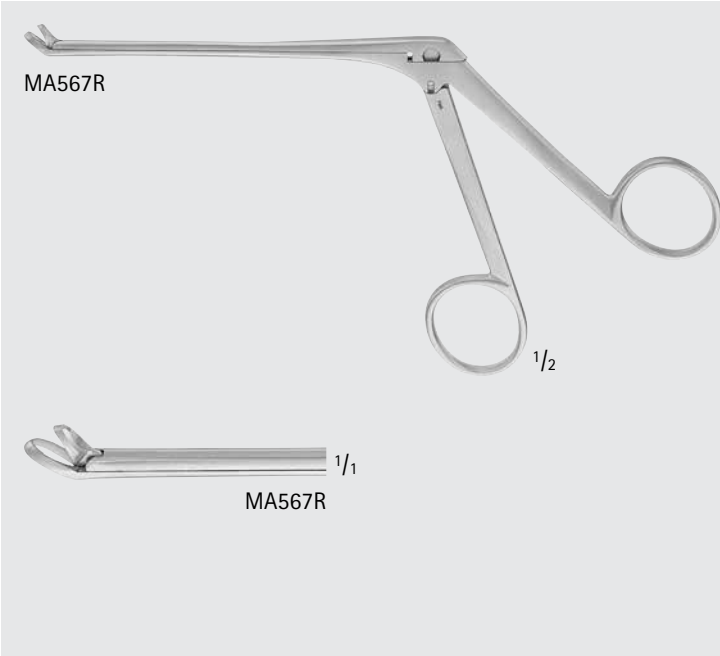

ENT-NASAL

Forceps- Nasal/Polyp/Bone Cutting

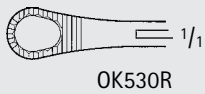

WATSON-WILLIAMS Ethmoid Forceps

Catalog Number	Jaw	Tip	Working Length (in.)
MA560R	3 MM THRU CUT JAWS W/ BASKET, ANG UP	ANG UP	5 3/8
OK530R	STR, SERR	STR	4 3/4

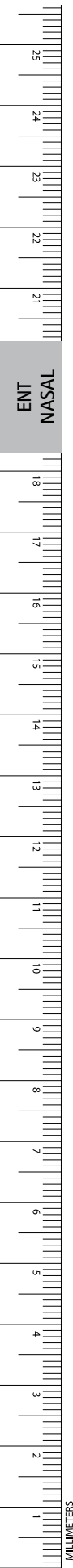

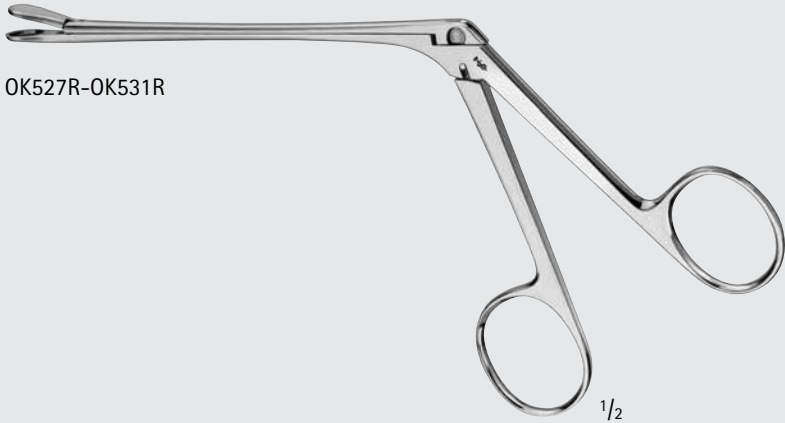

OK527R-OK531R

WATSON-WILLIAMS Ethmoid Forceps

Catalog Number	Jaw Size (mm)	Tip	Size	Working Length (in.)
OK527R	5.0	STR	SMALL	4 3/4
OK529R	7.0	STR	MEDIUM	4 3/4
OK531R	9.0	STR	LARGE	4 3/4

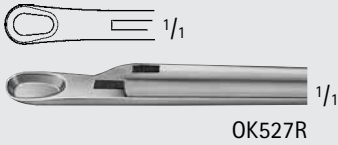

OK527R

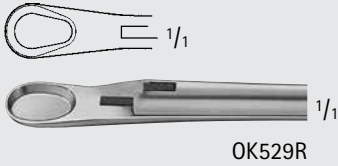

OK529R

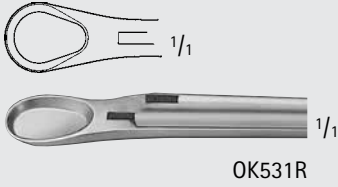

OK531R

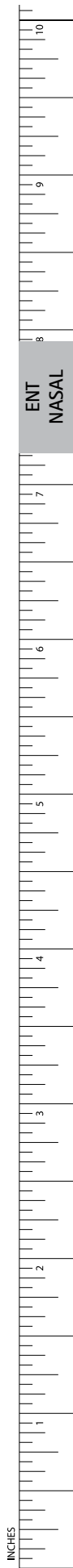

ENT-NASAL

Forceps- Nasal/Polyp/Bone Cutting

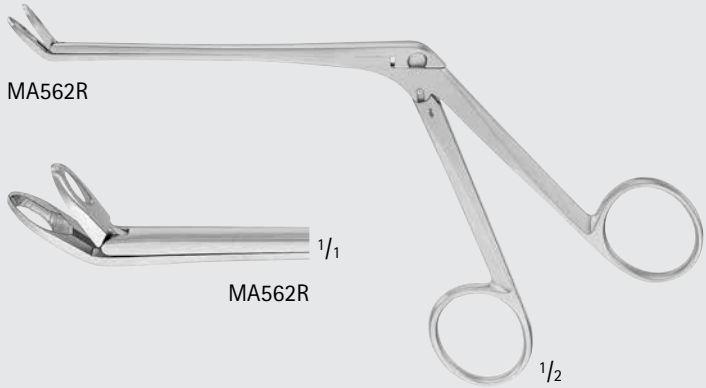

WILDE Nasal Forceps

Catalog Number	Jaw Size (mm)	Tip	Working Length (in.)	Length (in.)
MA561R	5 x 10	STR	4 1/2	7 1/4
MA562R	5 x 10	ANG UP	4 1/2	7 1/4

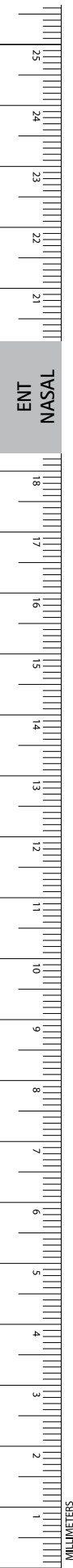

ENT-NASAL

Forceps- Nasal/Polyp/Bone Cutting

WILDE-Type Backbiter Forceps

Catalog Number	Jaw Size (mm)	Tip	Working Length (in.)	Length (in.)
MA688R	2	STR, ROTATING 360°	4 1/4	8 3/4
MA689R	2	CVD UP	3 1/8	6 7/8
MA690R	2	CVD DOWN	3 1/8	6 7/8

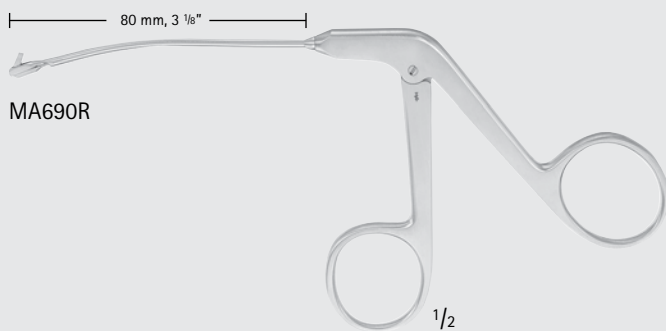
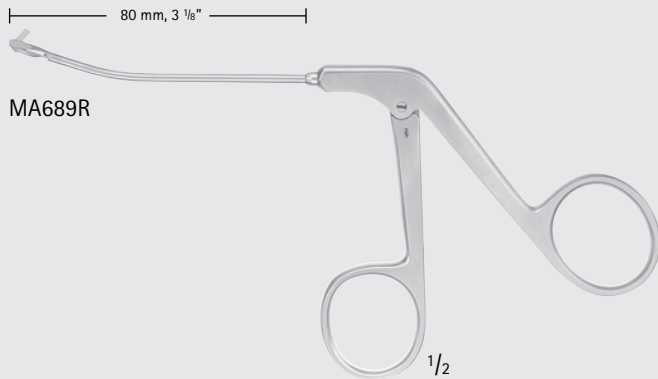
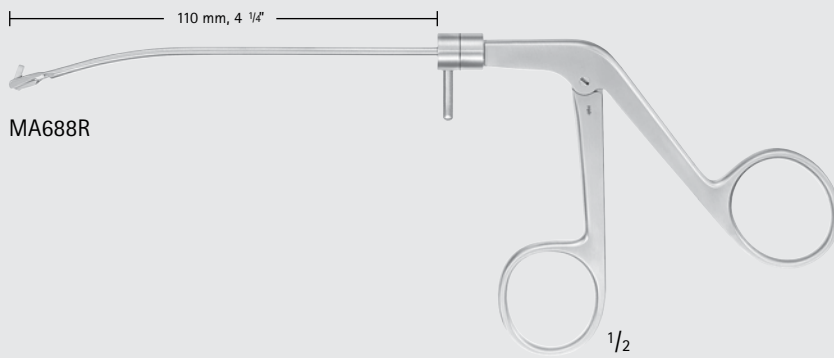

ENT-NASAL

Forceps- Cartilage/Morselizing/Straightening

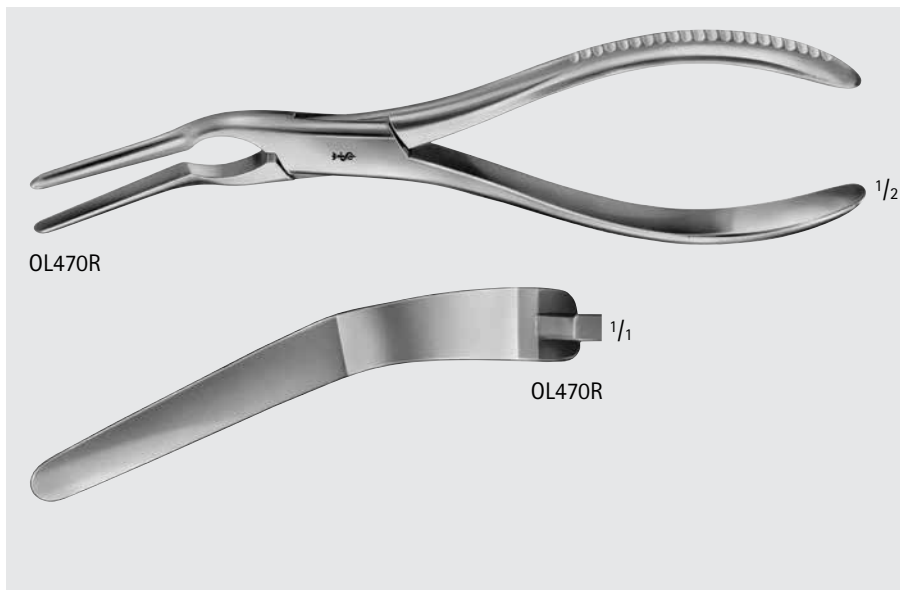
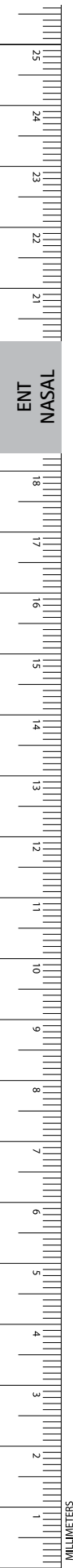

ASH Septum Forceps

Catalog Number	Tip	Length (in.)
OL470R	ANG	8 3/4

OL470R

OL470R

1/2

1/1

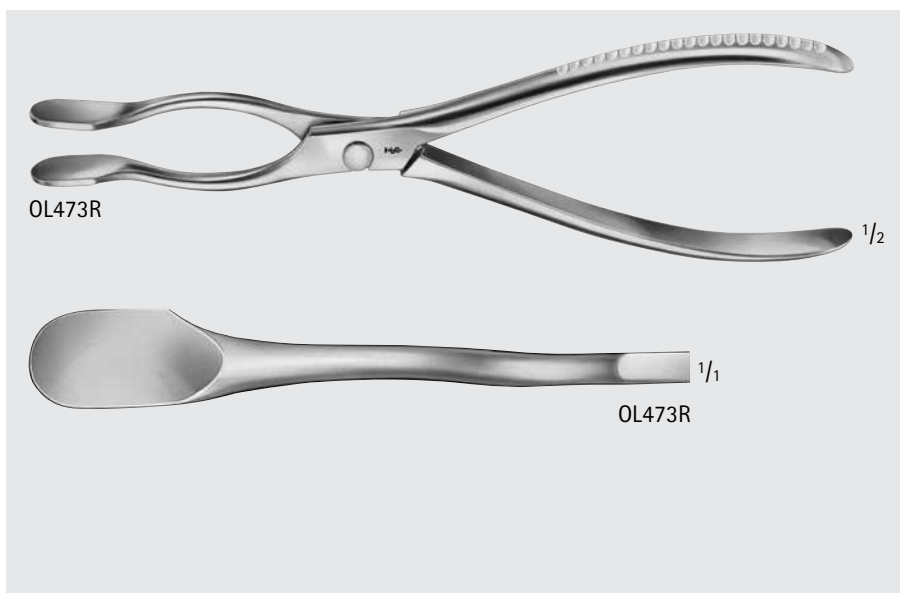

COTTLE-WALSHAM Septum Forceps

Catalog Number	Tip	Length (in.)
OL473R	STR	8 3/4

OL473R

OL473R

1/2

1/1

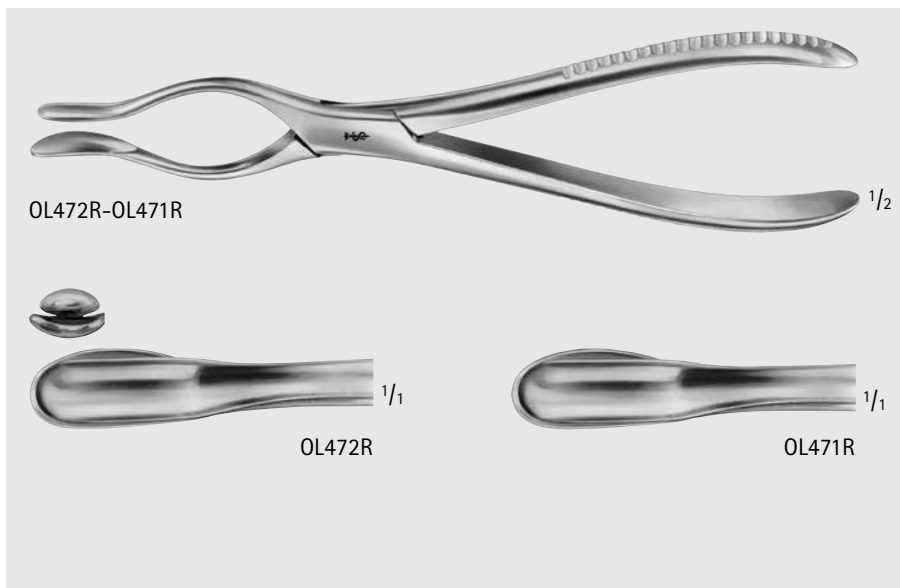

WALSHAM Septum Forceps

Catalog Number	Tip	Length (in.)
OL472R	LEFT	8 3/4
OL471R	RIGHT	8 3/4

OL472R-OL471R

OL472R

OL471R

1/2

1/1

1/1



Septum Morselizer Forceps,
W/ Removable Guard

Catalog Number	Length (in.)
OL474R	7 7/8



OL474R

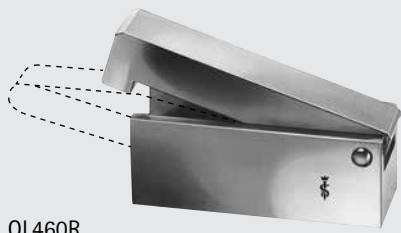

Bone and Cartilage Crusher, W/ Clamp

Catalog Number
OL460R

OL460R

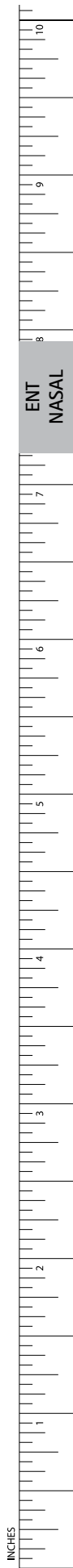

ENT-NASAL

Nasal Snares and Wires

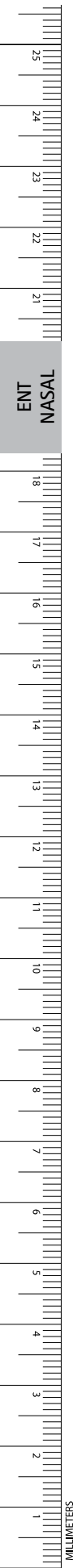

KRAUSE Nasal Polyp Snare, Knee-Shape

Catalog Number	Length (in.)
OK260R	9 3/4



OK260R

WILDE Nasal Polyp Snare

Catalog Number	Tip	Length (in.)
OK270R	BAYO	9 3/4

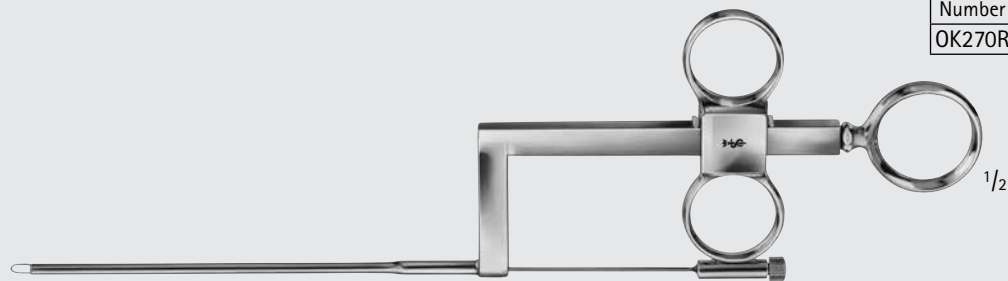

OK270R

Nasal Snare Wire

Catalog Number	Diameter (mm)	Packaging
OK293R	0.3	100/BOX

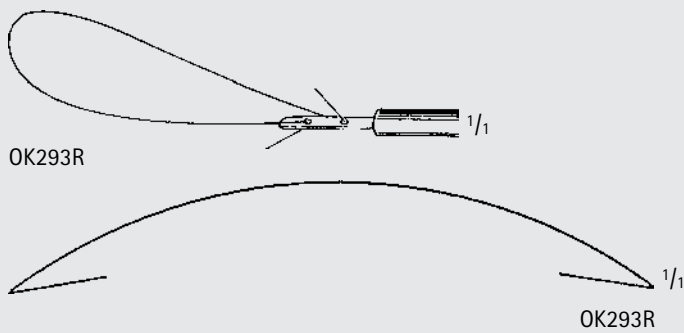

OK293R

OK293R



OL201R

1/2

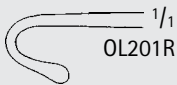

OL201R

1/1

LANGE Fistula Hook

Catalog Number	Tip	Length (in.)
OL201R	BLUNT	9 1/4



MA178R-MA179R

1/2

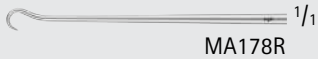

MA178R

1/1



MA179R

1/1

CONVERSE Skin Hooks

Catalog Number	Size	Length (in.)
MA178R	SMALL	7 1/8
MA179R	LARGE	7 1/8



OL207R

1/2



1/1



OL207R

1/1

CONVERSE Double Hook

Catalog Number	Blade Size (mm)	Length (in.)
OL207R	7 x 12 / 8 x 12	4 3/4



MA186R

1/2



MA186R

1/1

MILLARD Double Hook W/ Thimble Mount

Catalog Number	Length (in.)
MA186R	3 1/4

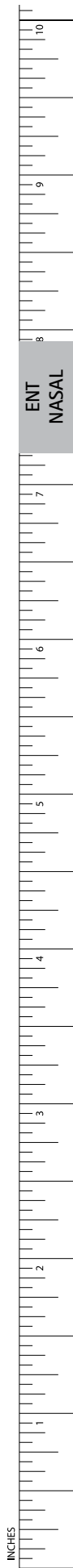

ENT-NASAL

Retractors



OK099R-MA422R

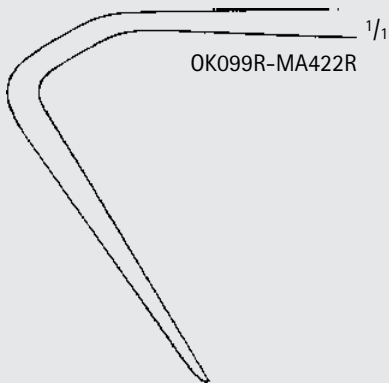

OK099R-MA422R

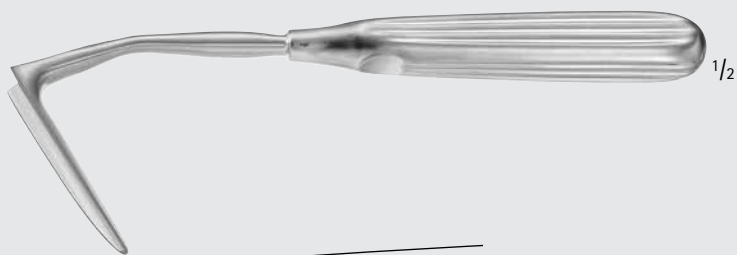

MA423R

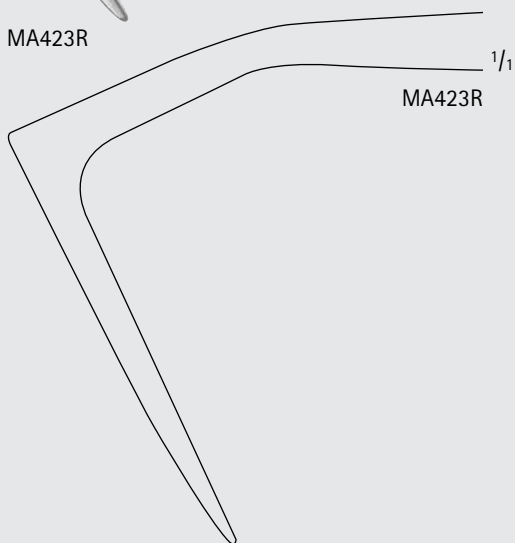

MA423R

AUFRICHT Nasal Retractor

Catalog Number	Blade Size (mm)	Length (in.)
OK099R	10 x 45	6 7/8
MA422R	10 x 45	7 3/8
MA423R	11 x 60	7 3/8

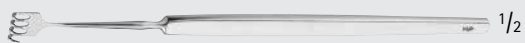

MA424R

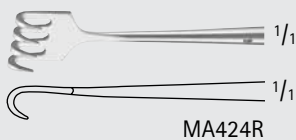

MA424R

Blair Retractor

Catalog Number	Tip	Blade End	Tip Size (mm)	Length (in.)
MA424R	SHARP	4 PRONGS	7	5 1/4

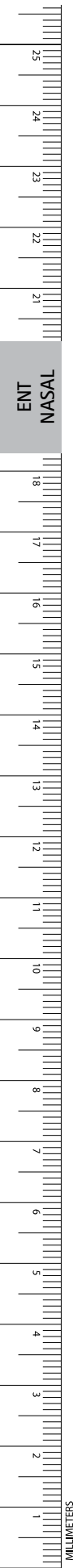

CONVERSE Nasal Retractor

Catalog Number	Blade Size (mm)	Length (in.)
MA425R	9 x 18	3 1/4
MA426R	12 x 21	3 1/4
MA427R	12 x 38	3 1/4
MA428R	12 x 53	3 1/4
MB107R	44 x 11	4 1/2



MA425R

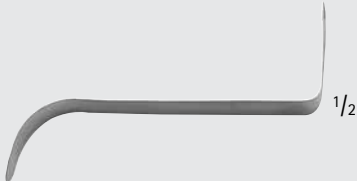

MA426R



MA427R

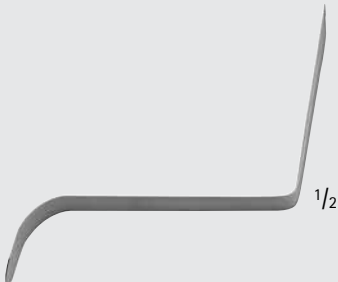

MA428R



MB107R



ENT-NASAL

Retractors



MA430R



MA430R

COTTLE Nasal Retractor

Catalog Number	Tip	Blade End	Tip Size (mm)	Length (in.)
MA430R	BLUNT	4 PRONGS	10	5 1/8



OL214R



1/1



OL214R

COTTLE Nasal Retractor, Double Ended

Catalog Number	Blade Size (mm)	Tip	Length (in.)
OL214R	12 x 5 / 4 x 4.5	BALL END/ BLUNT	7 7/8



OL203R-OL204R



OL203R



OL204R

COTTLE Retractor

Catalog Number	Tip	Length (in.)
OL203R	BLUNT/RIGHT SHARP	5 3/4
OL204R	LEFT SHARP/BLUNT	5 3/4

ENT
NASAL

MILLIMETERS



OL212R



OL212R



OL211R



OL211R

COTTLE Alar (MASING) Retractor

Catalog Number	Blade Size (mm)	Length (in.)
OL211R	6 x 12	5 1/2
OL212R	10 x 12	5 1/2



OL202R

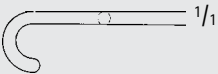

OL202R



MA431R



MA431R

FOMON Retractor

Catalog Number	Tip Size (mm)	Tip	Blade End	Length (in.)
OL202R	12	BLUNT	2 PRONGS	5 3/4
MA431R	13	BALL END	2 PRONGS	6 1/4

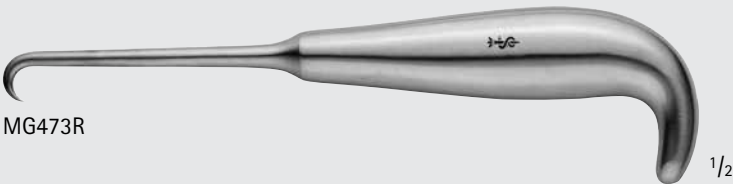

MG473R

GILLIES Bone and Zygoma Hook

Catalog Number	Tip Size (mm)	Length (in.)
MG473R	9	7 1/4



ENT-NASAL

Retractors

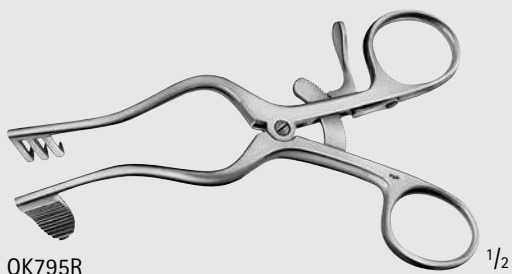

OK795R $\frac{1}{2}$

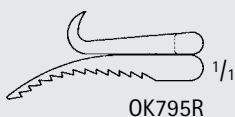

OK795R $\frac{1}{1}$

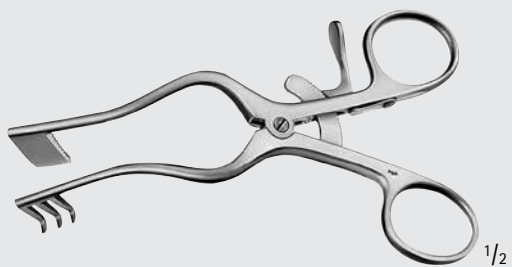

$\frac{1}{2}$

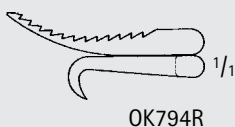

OK794R $\frac{1}{1}$



$\frac{1}{1}$

PERKINS Antrum Retractor

Catalog Number	Right Blade	Left Blade	Length (in.)
OK795R	3 PRONGS	SOLID	5
OK794R	SOLID	3 PRONGS	5

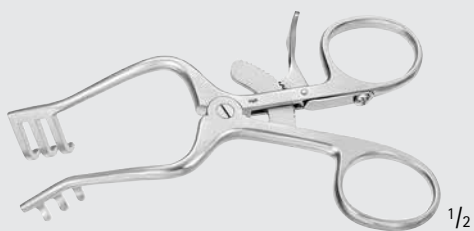

MA438R $\frac{1}{2}$

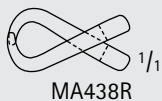

MA438R $\frac{1}{1}$

Baby WEITLANER Retractor

Catalog Number	Tip	Blade End	Length (in.)
MA438R	BLUNT	3 x 3 PRONGS	4 1/4

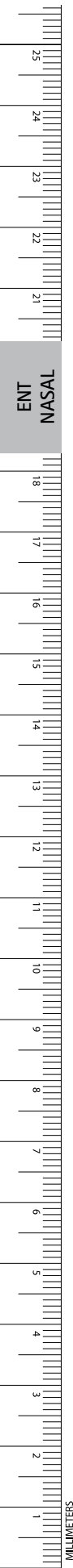



MB054R

1/2



1/1

MB054R

WULLSTEIN Retractor

Catalog Number	Tip	Blade End	Length (in.)
MB054R	BLUNT	3 x 3 PRONGS	4 1/4



BV030R

1/2



1/1

BV030R



BV032R

1/2



1/1

BV032R



BV033R

1/2

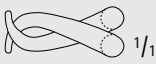

1/1

BV033R

JANSEN Retractor

Catalog Number	Tip	Blade End	Length (in.)
BV030R	SHARP	3 x 3 PRONGS	4
BV032R	BLUNT	3 x 3 PRONGS	4
BV033R	BLUNT	3 x 4 PRONGS	4

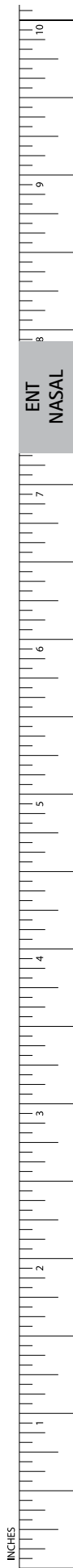

ENT
NASAL

INCHES

ENT-NASAL

Elevators and Dissectors



BOIES Nasal Fracture Elevator

Catalog Number	Tip	Length (in.)
OL477R	BLUNT	7



GOLDMANN Septum Displacer

Catalog Number	Tip	Length (in.)
OL479R	STR	7 7/8

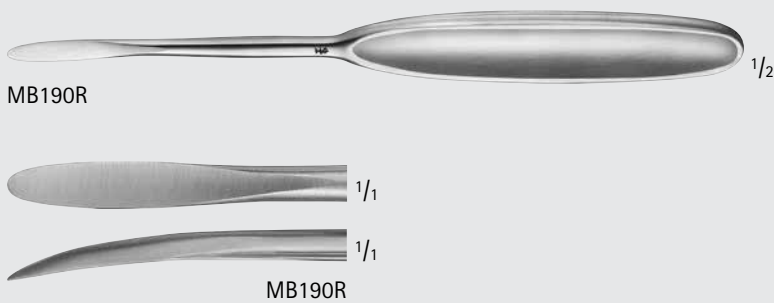

CUSHING Elevator, Narrow

Catalog Number	Tip Size (mm)	Tip	Length (in.)
MB190R	8	SHARP	7 3/4

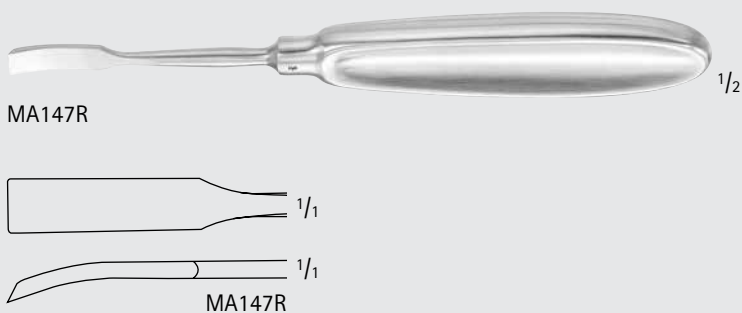

LEMPERT Elevator

Catalog Number	Tip Size (mm)	Blade	Length (in.)
MA147R	7	CVD	7 1/4

ENT
NASAL

MILLIMETERS



MA145R-MA146R

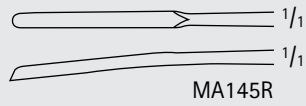

MA145R

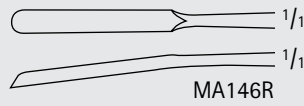

MA146R

LEMPERT Elevator

Catalog Number	Tip	Tip Size (mm)	Length (in.)
MA145R	SLIGHT CVD	2	6 3/4
MA146R	SLIGHT CVD	3	6 3/4
OG163R	STR	3	7 1/2
OG164R	BROAD, SLIGHT CVD	6	7 1/4



OG163R

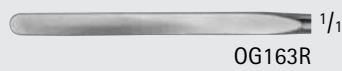

OG163R



OG164R

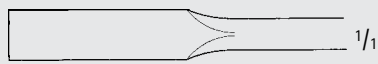

1/1

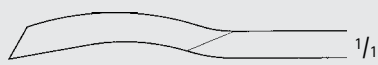

1/1

OG164R



MA290R



MA290R 1/1

KLEINERT-KUTZ Elevator and Dissector, Double Ended

Catalog Number	Tip Size (mm)	Length (in.)
MA290R	2/4	7



OL192R

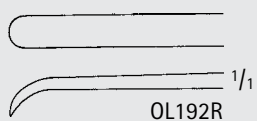

OL192R

MCKENTY Periosteal Elevator

Catalog Number	Tip	Tip Size (mm)	Length (in.)
OL192R	CVD, SHARP	4.0	6



ENT
NASAL

INCHES

ENT-NASAL

Elevators and Dissectors

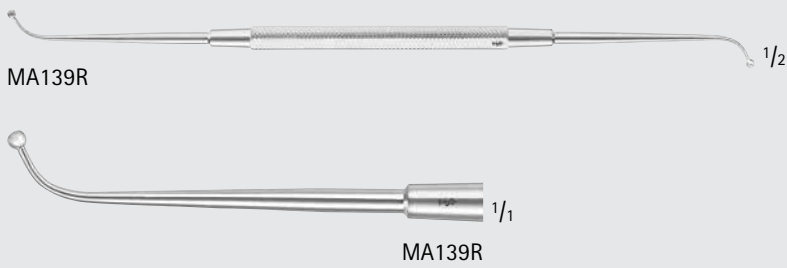

Ball End Elevator, Double Ended

Catalog Number	Blade Shape	Length (in.)
MA139R	ANG	7 1/2

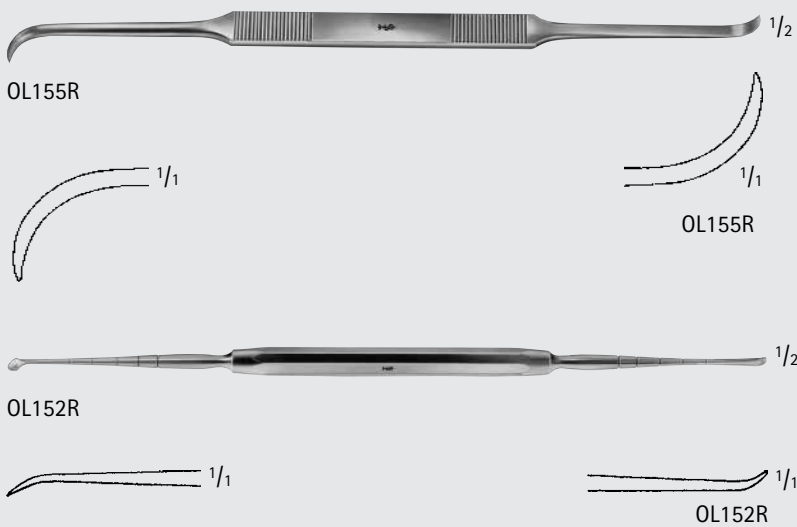

COTTLE Elevator, Double Ended

Catalog Number	Blade	Length (in.)
OL155R	-	7 7/8
OL152R	GRADUATED	7 7/8

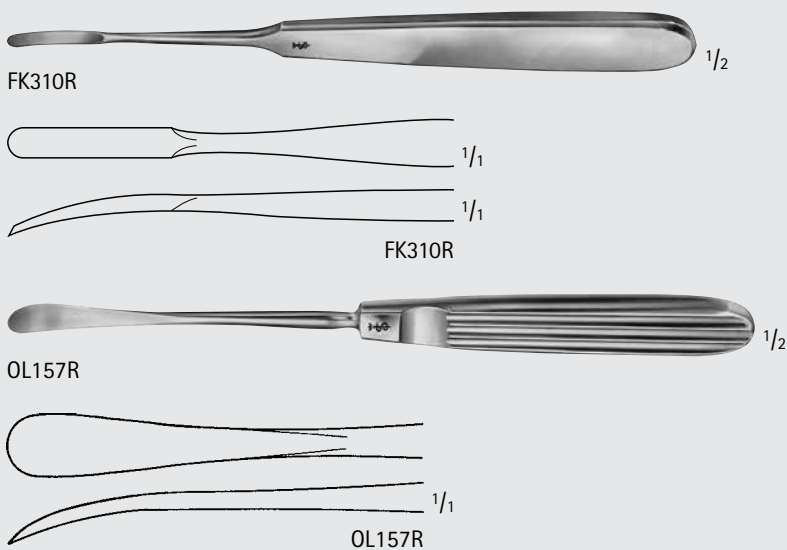

COTTLE Periosteal Elevator

Catalog Number	Tip	Width (mm)	Length (in.)
FK310R	SLIGHTLY CVD	4	7
OL157R	CVD, SHARP	8	7 3/4



ENT-NASAL

Elevators and Dissectors

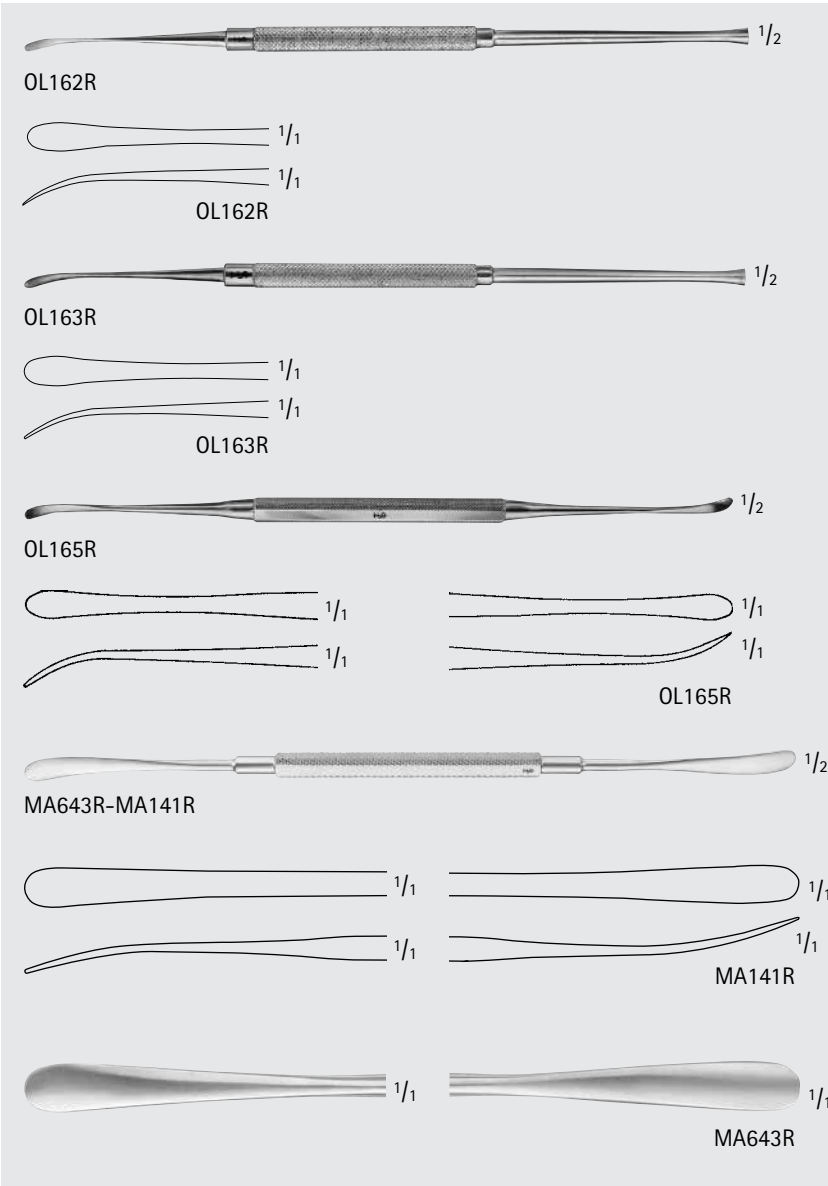

FREER Elevator

Catalog Number	Tip	Tip Size (mm)	Length (in.)
OL162R	SINGLE ENDED SHARP	4	7 1/2
OL163R	SINGLE ENDED BLUNT	4	7 1/2
OL165R	SHARP/BLUNT	4 / 4	7 1/4
MA643R	SHARP/BLUNT	4.5 / 4.5	7 1/2
MA141R	SHARP/BLUNT	6.5	7 1/2

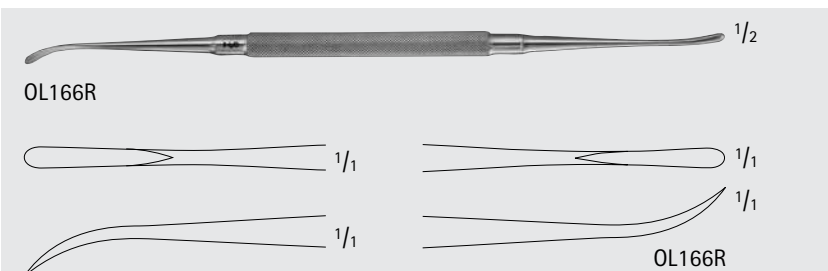

FREER-YASARGIL Elevator

Catalog Number	Tip	Length (in.)
OL166R	SHARP/SHARP	7 1/4



ENT-NASAL

Elevators and Dissectors



OL198R

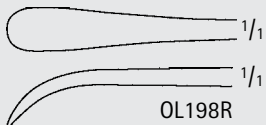

SEWALL Antrum Elevator

Catalog Number	Tip	Tip Size (mm)	Length (in.)
OL198R	BLUNT	5.9	7 7/8



MB297R

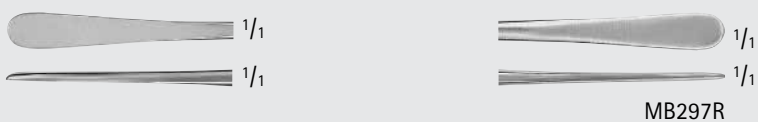

HAJEK-BALLENGER Septum Elevator and Dissector, Double Ended

Catalog Number	Tip	Length (in.)
MB297R	SHARP/BLUNT	7 1/2



OL153R

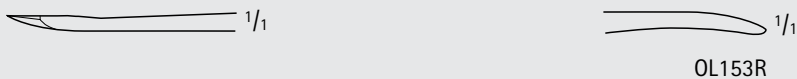

COTTLE (MASING) Elevator, Graduated

Catalog Number	Blade	Length (in.)
OL153R	DBL ENDED	7 7/8



OL151R

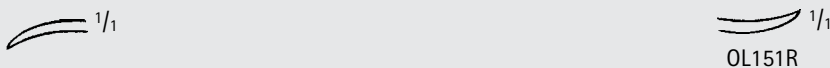

PENNINGTON Elevator

Catalog Number	Tip	Length (in.)
OL151R	SHARP/SHARP	8 1/4



MB313R

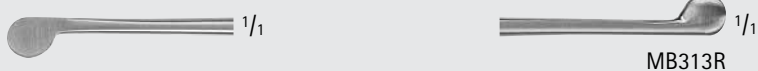

PIERCE Submucous Dissector

Catalog Number	Length (in.)
MB313R	7 1/2



MB312R

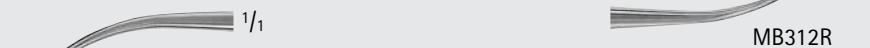

ROGERS Submucous Dissector

Catalog Number	Length (in.)
MB312R	8 3/4

ENT
NASAL

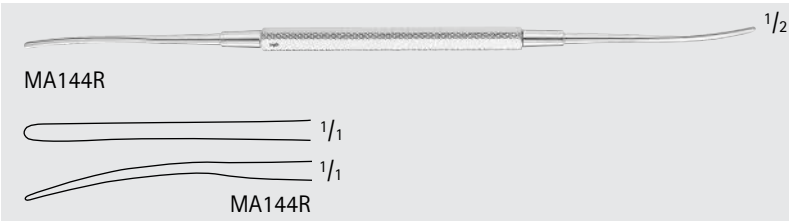

HENNER Elevator, Double Ended

Catalog Number	Tip Size (mm)	Length (in.)
MA144R	2/2	8 1/2

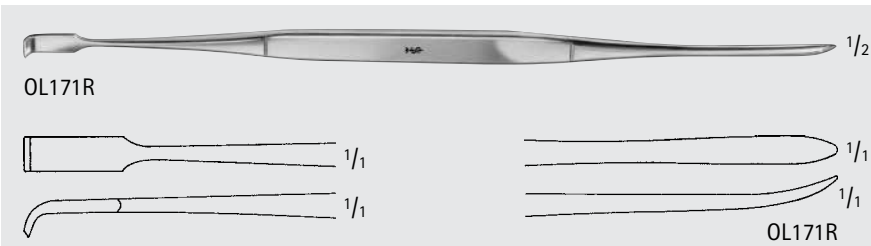

HOWARTH Elevator, Double Ended

Catalog Number	Tip	Length (in.)
OL171R	SHARP/BLUNT	8 1/2

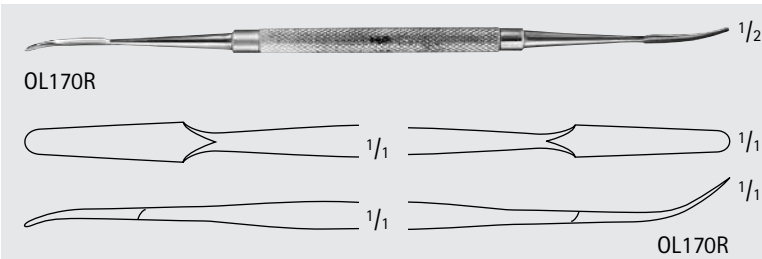

KILLIAN Elevator, Double Ended

Catalog Number	Tip	Length (in.)
OL170R	SHARP/BLUNT	7 1/4

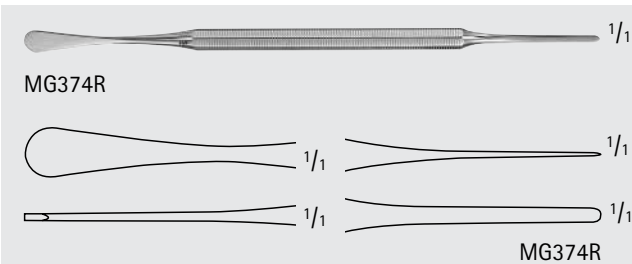

Spatula and Packer, Double Ended

Catalog Number	Length (in.)
MG374R	5 3/4



ENT-NASAL

Elevators and Dissectors



OL160R

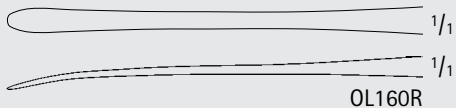

HALLÉ Elevator

Catalog Number	Tip	Tip Size (mm)	Length (in.)
OL160R	BLUNT	3.3	7



OM307, OM309R, OM308R

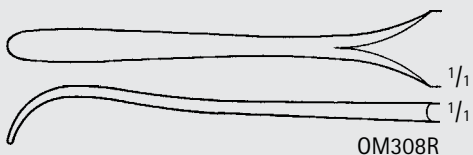
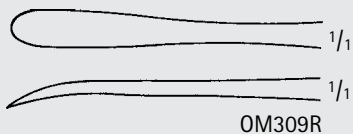
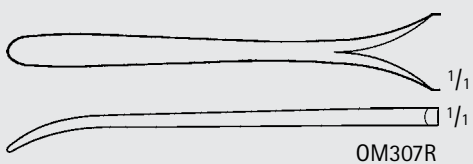

KOENIG Elevator

Catalog Number	Tip	Tip Size (mm)	Length (in.)
OM307R	SLIGHTLY CVD	4.5	6 1/8
OM309R	SLIGHTLY CVD	4.5	6 1/8
OM308R	STRONGLY CVD	4.5	6 1/8



MA143R



OBWEGESER-FREER Elevator

Catalog Number	Tip	Tip Size (mm)	Blade Shape	Length (in.)
MA143R	BLUNT	6	DBL ENDED	8 1/2

ENT
NASAL

MILLIMETERS

COTTLE Septum Speculum

Catalog Number	Blade Size (mm)	Blade Shape	W/ Set Screw	Length (in.)
OK085R	50 x 6	TAPERED	NO	5 1/4
OK089R	76 x 7	THIN	YES	5 1/4
OK090R	90 x 7	THIN	YES	5 1/4



OK085R

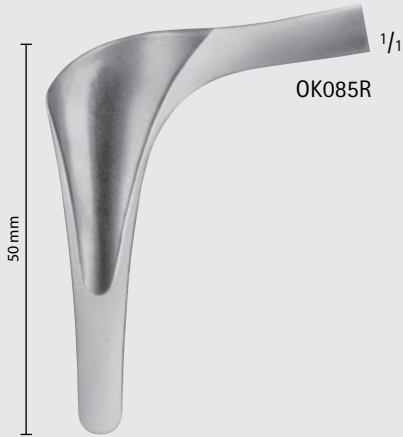

OK085R



OK089R-OK090R

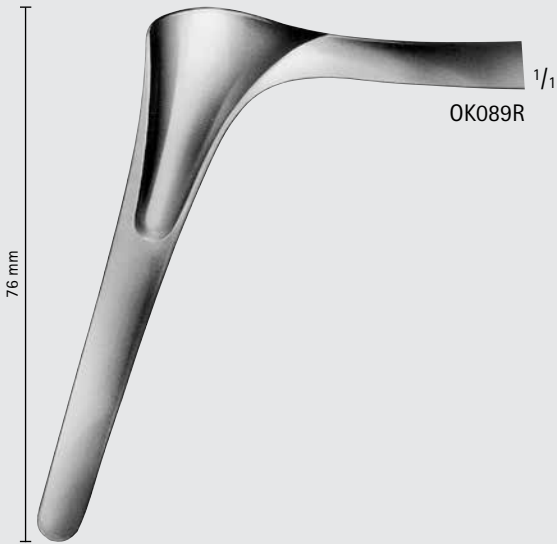

OK089R

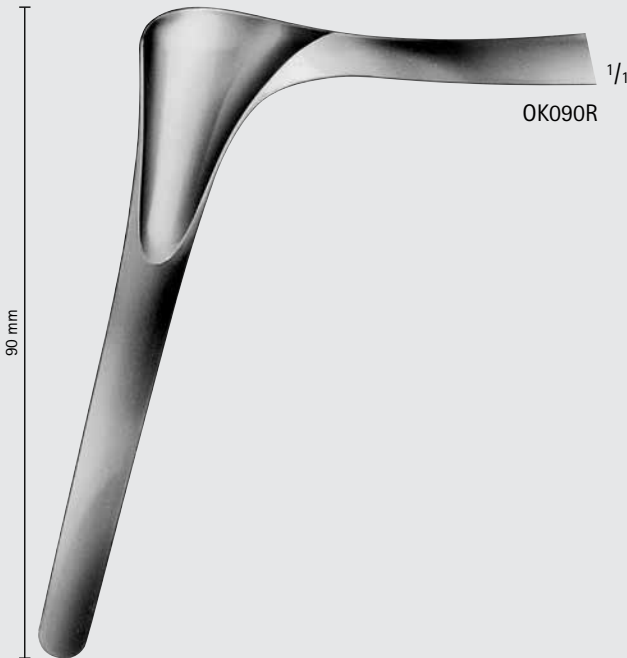

OK090R

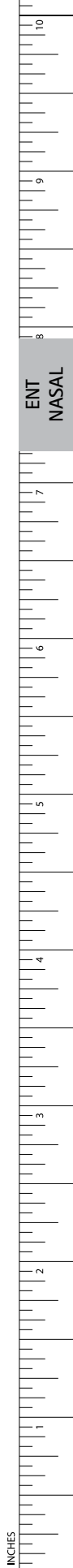

INCHES

ENT-NASAL

Specula

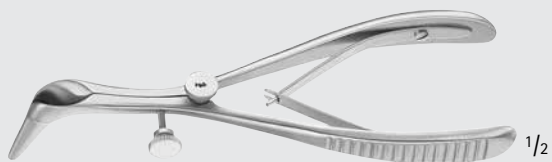

OK105R-OK108R

COTTLE Nasal Speculum

Catalog Number	Blade Size (mm)	Blade Shape	Size (#)	Length (in.)
OK105R	20	Xtra Thin	1	5 1/4
OK106R	38	Xtra Thin	2	5 1/4
OK107R	41	Xtra Thin	3	5 1/4
OK108R	60	Xtra Thin	4	5 1/4

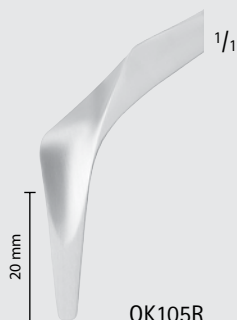

OK105R



OK106R



OK107R

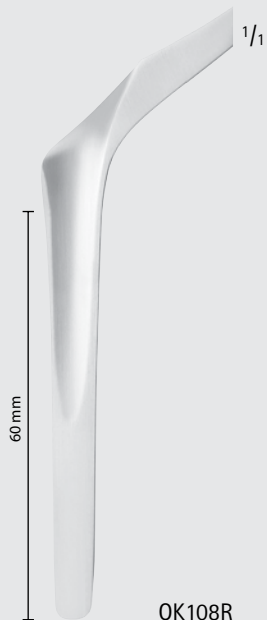

OK108R

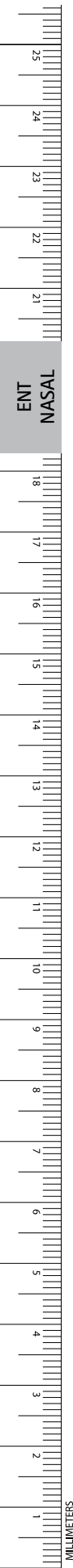

COTTLE Septum Speculum (continued)

Catalog Number	Blade Size (mm)	Blade Shape	Length (in.)
MA346R	50	THIN	5 5/8



MA346R

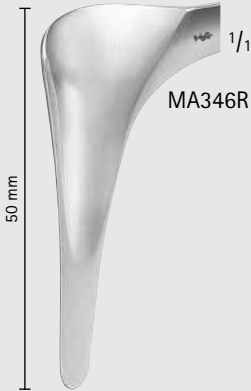

KILLIAN Septum Speculum, Aseptic

Catalog Number	Blade Size (mm)	Length (in.)
OK081R	36 x 7	5 1/2
OK082R	56 x 7	5 1/2
OK083R	75 x 7	5 1/2
OK084R	90 x 7	5 1/2



OK081R-OK084R

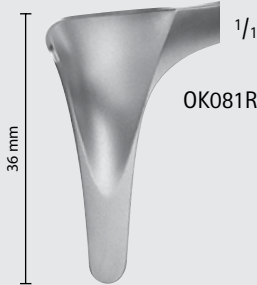

OK081R

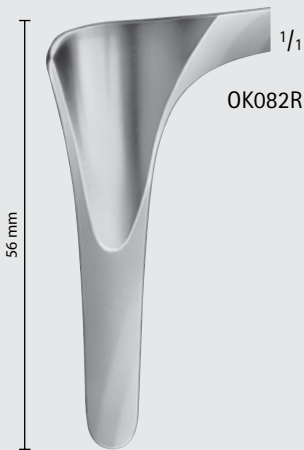

OK082R

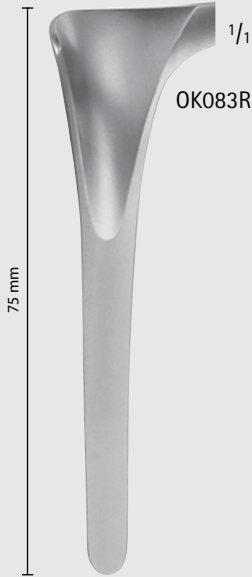

OK083R

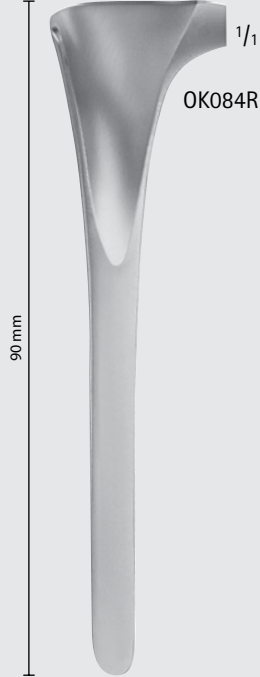

OK084R

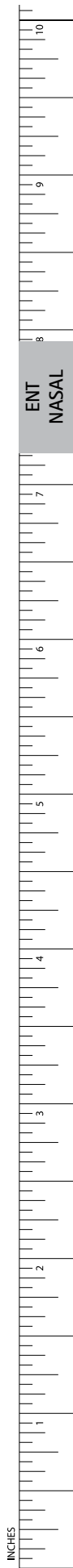

ENT-NASAL

Specula



OK091R-OK094R

KILLIAN Septum Speculum W/ Screw Joint

Catalog Number	Blade Size (mm)	Length (in.)
OK091R	36 x 7	5 3/4
OK092R	56 x 7	5 3/4
OK093R	75 x 7	5 3/4
OK094R	90 x 7	5 3/4

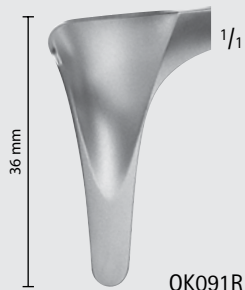

OK091R

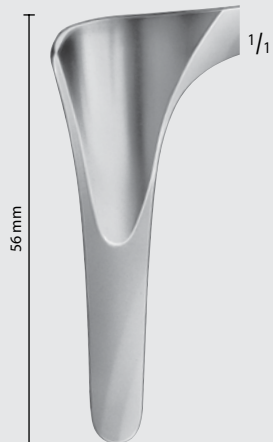

OK092R

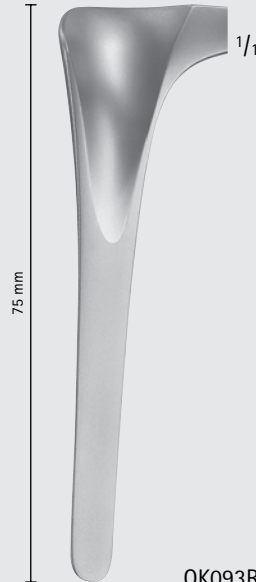

OK093R

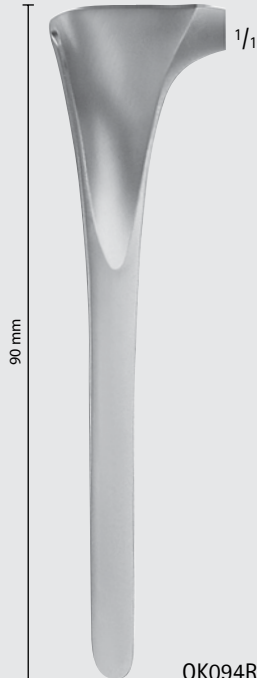

OK094R

ENT
NASAL

MILLIMETERS

VIENNA Nasal Speculum

Catalog Number	Blade Size	Length (in.)
OK060R	SMALL	5 1/2
OK061R	MEDIUM	5 1/2
OK062R	LARGE	5 1/2



OK060R

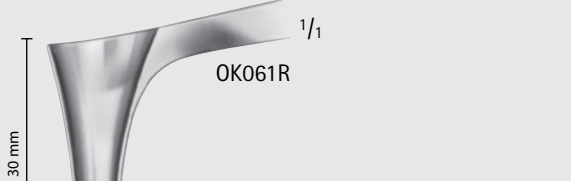

OK061R

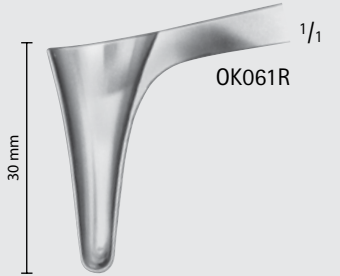

OK062R



ENT-NASAL

Specula



MA348R-MA350R

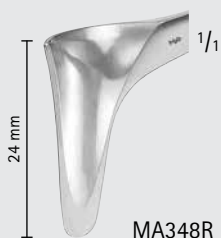

MA348R

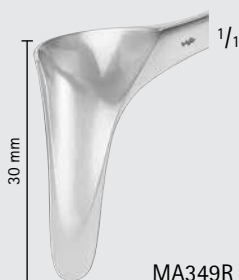

MA349R

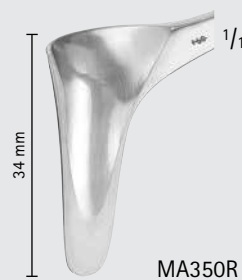

MA350R

VIENNA Nasal Speculum (continued)

Catalog Number	Blade Size (mm)	Tip Size (mm)	Length (in.)
MA348R	24	1	5 1/4
MA349R	30	3	5 1/4
MA350R	34	4	5 1/4



OK030R



OK030R



OK041R-OK043R



OK041R



OK042R

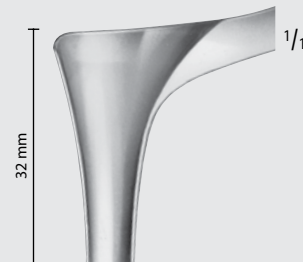

OK043R

HARTMANN Nasal Speculum

Catalog Number	Blade Size	Length (in.)
OK030R	LIGHT	5 3/4
OK041R	SMALL	6 1/4
OK042R	MEDIUM	6 1/4
OK043R	LARGE	6 1/4

ENT
NASAL

MILLIMETERS



OK047R-OK049R

HARTMANN-HALLE Nasal Speculum W/ Screw Joint

Catalog Number	Blade Size	Length (in.)
OK047R	SMALL	6 1/8
OK048R	MEDIUM	6 1/8
OK049R	LARGE	6 1/8

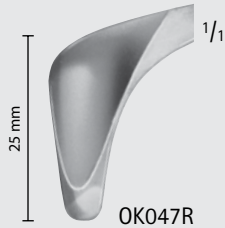

OK047R

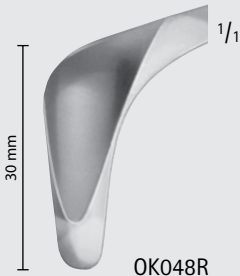

OK048R

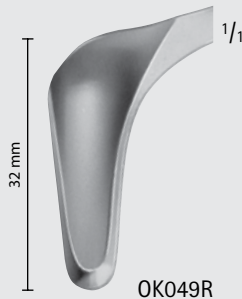

OK049R



OK051R-OK052R

TIECK-HALLE Nasal Speculum W/ Screw Joint, Pediatric

Catalog Number	Blade Size	Length (in.)
OK051R	SMALL	5 1/4
OK052R	LARGE	5 1/4



OK051R

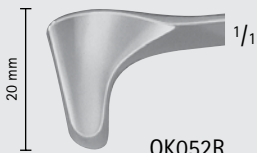

OK052R

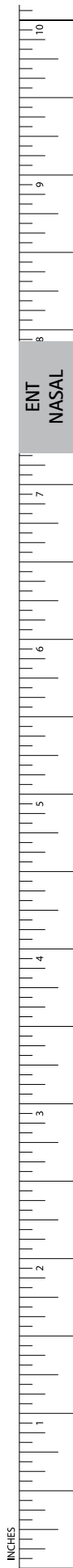

ENT-NASAL

Specula

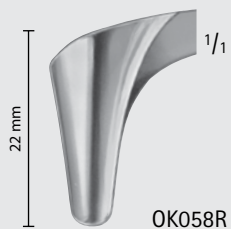

BECKMANN Nasal Speculum W/ Screw Joint, Pediatric

Catalog Number	Blade Size	Blade Shape	Length (in.)
OK053R	SMALL	LAT-CVD	5 1/2
OK058R	MEDIUM	LAT-CVD	6



SONNENSCHN Nasal Speculum

Catalog Number	Blade Size	Length (in.)
MB318R	MEDIUM	6

ENT
NASAL



OK100R-OK102R



OK103R

CUSHING-LANDOLT Transsphenoidal Speculum

Catalog Number	Blade Size (mm)	Length (in.)
OK100R	70 x 15	-
OK101R	90 x 15	-
OK102R	110 x 15	-
OK103R	SPREADER FOR OK100R-OK102R	8 1/4



FF589R-FF591R



TE749R



FF595R



FF595R

PAPAVERO-HARTMANN (CASPAR) Transsphenoidal Speculum, Slim, W/ Key

Catalog Number	Blade Size (mm)	Description	Length (in.)
FF589R	80 x 11	-	-
FF590R	90 x 13	-	-
FF591R	100 x 15	-	-
TE749R	-	HEX KEY	-
FF595R	34 x 9	SPREADER FOR FF589R-FF591R	5 1/2

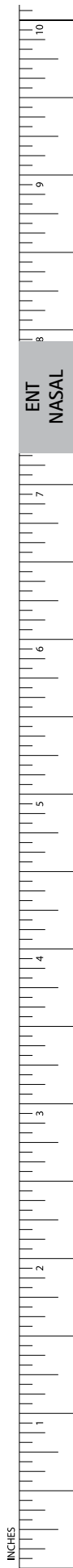

INCHES

ENT-NASAL

Rasps, Files and Saws

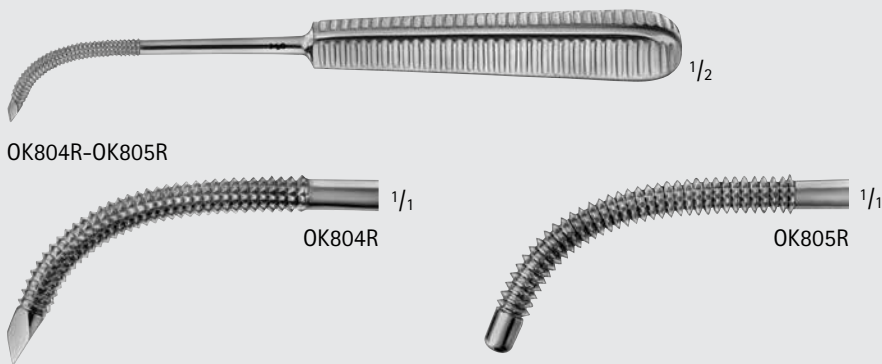

Antrum Rasp

Catalog Number	Tip	Length (in.)
OK804R	SHARP	7
OK805R	BLUNT	7



WEINER Antrum Rasp Trocar

Catalog Number	Tip	Length (in.)
MA421R	EXTRA SMALL, TROCAR	7 3/8

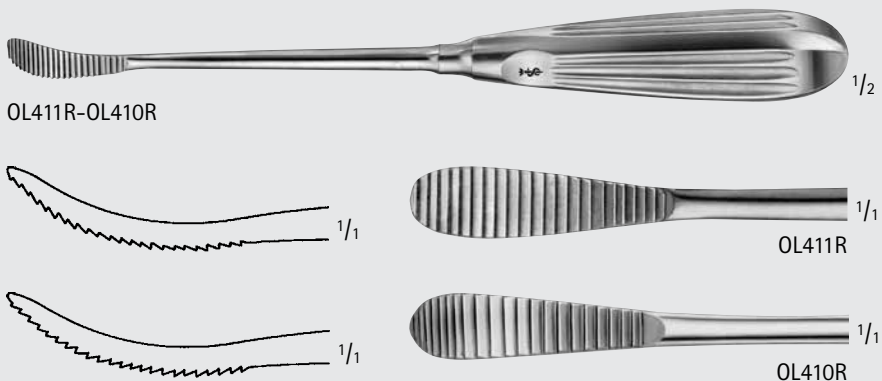

AUFRICHT Nasal Rasp

Catalog Number	Tip Size (mm)	Tip	Length (in.)
OL411R	9	DOWN-CUT	8 3/4
OL410R	9	UP-CUT	8 3/4



COTTLE Rasp

Catalog Number	Tip	Length (in.)
MA706R	DOWN CUTTING	8 1/4

ENT
NASAL

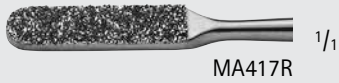

Diamond Dust Rasp

Catalog Number	Tip	Length (in.)
MA417R	STR	7 3/8
MA416R	CVD	7 3/8

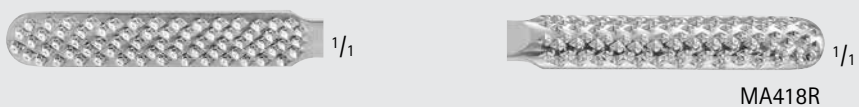
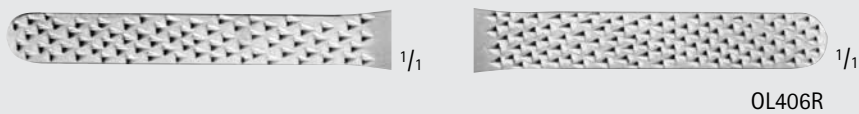
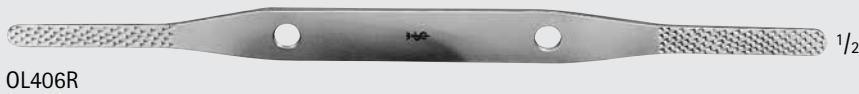

FOMON Bone Rasp, Double Ended

Catalog Number	Tip Size (mm)	Tip	Length (in.)
OL405R	6.5 / 7.5	X-SERR Fine/Coarse	8 1/2
OL406R	6.5 / 7.5	Fine/Coarse	8 1/2
MG584R	8/8	FLAT, CONVEX FINE, COARSE	8 1/2
MA418R	7.5 / 7.5	Coarse/ Xtra-Coarse	8 3/8



GALLAHER File Rasp, Coarse

Catalog Number	Tip Size (mm)	Length (in.)
OL412R	6.5	7 1/2

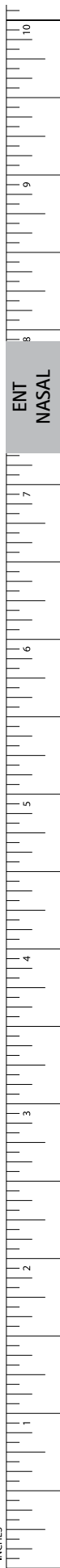

ENT-NASAL

Rasps, Files and Saws



OL448R



OL451R

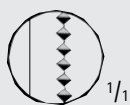

OL452R

JOSEPH Nasal Saw, Bayonet

Catalog Number	Blade Shape	Length (in.)
OL448R	STR	7 3/4
OL451R	CVD RIGHT	7 3/4
OL452R	CVD LEFT	7 3/4



OL401R-OL403R

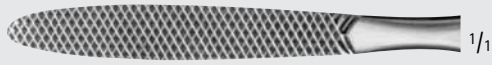

OL401R

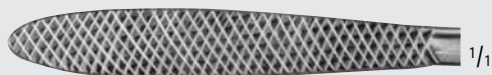

OL403R

JOSEPH Nasal Saw

Catalog Number	Tip	Tip Size (mm)	Length (in.)
OL401R	FINE-SERR	7.5	6 1/2
OL403R	COARSE-SERR	9	6 1/2



OL408R-OL409R

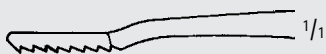

OL408R



OL409R

LEWIS Bone Rasp

Catalog Number	Tip	Tip Size (mm)	Length (in.)
OL408R	FINE-SERR DOWN-STROKE	8	6 7/8
OL409R	COARSE-SERR DOWN-STROKE	8	6 7/8

ENT
NASAL

MILLIMETERS



MB110R



MB110R

MALTZ-ANDERSON Nasal Rasp

Catalog Number	Tip Size (mm)	Length (in.)
MB110R	5.7	6 1/2



OL407R

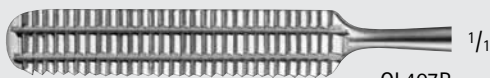

OL407R



MA419R



MA419R



MA420R



MA420R

MALTZ Bone Rasp

Catalog Number	Tip Size (mm)	Tip	Length (in.)
OL407R	9	DOWN-STROKE	6 1/2
MA419R	33	DOWN-STROKE	6 1/2
MA420R	33	UP STROKE	6 1/2



MB330R



MB330R

PARKES Nasal Rasp

Catalog Number	Tip Size (mm)	Length (in.)
MB330R	8	7 7/8

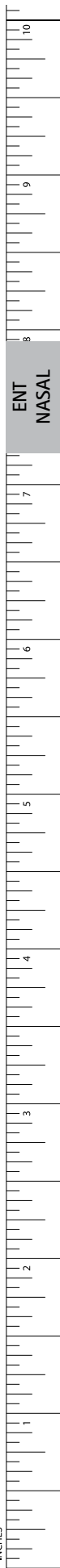

INCHES

ENT-NASAL

Chisels and Gouges

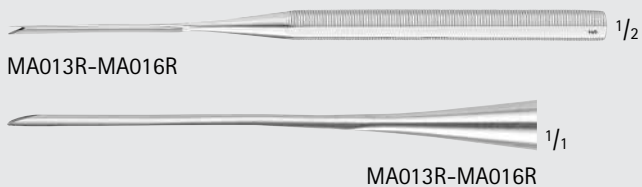

BALLENGER Chisel, V-shaped

Catalog Number	Tip Size (mm)	Length (in.)
MA013R	2	5 7/8
MA014R	4	5 7/8
MA016R	8	5 7/8

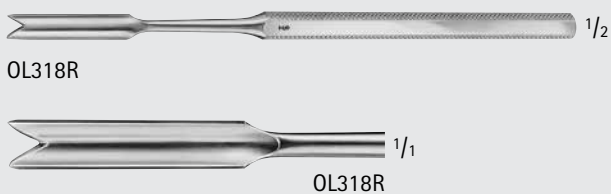

BALLENGER Septum Gouge

Catalog Number	Tip Size (mm)	Length (in.)
OL318R	6	6

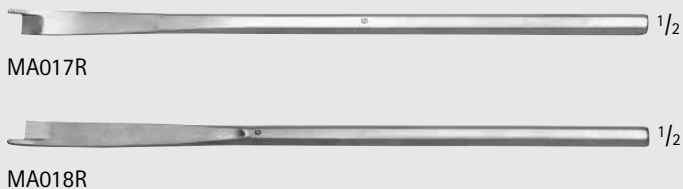

CONVERSE Guarded Chisel

Catalog Number	Tip Size (mm)	Blade Shape	Length (in.)
MA017R	6	CVD RIGHT	7 1/2
MA018R	6	CVD LEFT	7 1/2



COTTLE Chisel W/ Depth Marks

Catalog Number	Tip Size (mm)	Length (in.)
OL301R	4	7
OL302R	7	7
OL303R	9	7
OL304R	12	7



OL311R

1/2

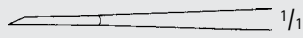

OL311R

1/1



OL314R

1/2

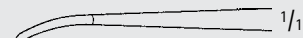

OL314R

1/1

FREER Chisel

Catalog Number	Tip Size (mm)	Blade Shape	Length (in.)
OL311R	4	STR	6 1/4
OL314R	4	CVD	6 1/4



FF610R

1/2

PAPAVERO Bayonet Chisel

Catalog Number	Tip Size (mm)	Length (in.)
FF610R	4	8 3/4



OL316R

1/2

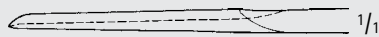

OL316R

1/1

FREER Septum Gouge

Catalog Number	Tip Size (mm)	Length (in.)
OL316R	4	6



OL336R

1/2



OL336R

1/1

KILLIAN Septum Gouge, Bayonet

Catalog Number	Tip Size (mm)	Length (in.)
OL336R	6	6 3/4



MB108R, MA629R

1/2



MB108R, MA629R

1/1

PARKES Hump Gouge, Double Guard

Catalog Number	Tip Size (mm)	Blade Shape	Length (in.)
MB108R	10	STR	7
MA629R	6	STR	7

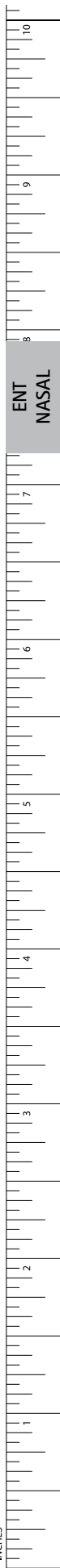

ENT-NASAL

Osteotomes

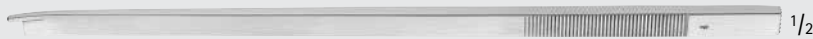

MA382R

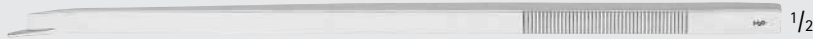

MA381R

ANDERSON-NEIVERT Osteotome

Catalog Number	Tip Size (mm)	Blade Shape	Length (in.)
MA382R	5	CVD RIGHT	8
MA381R	5	CVD LEFT	8



MB590R-MB594R

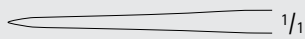

MB590R-MB594R

CHERRY Osteotome

Catalog Number	Tip Size (mm)	Length (in.)
MB590R	3	8
MB591R	4	8
MB592R	5	8
MB593R	6	8
MB594R	7	8



MA369R

CINELLI Osteotome, Double Guard

Catalog Number	Tip Size (mm)	Blade Shape	Length (in.)
MA369R	10	CVD	6 1/8

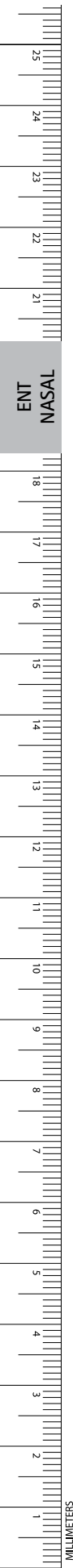



OL326R-OL329R



OL326R



OL327R



OL328R



OL329R

CINELLI Osteotome, Double Guard

Catalog Number	Tip Size (mm)	Blade	Length (in.)
OL326R	10	STR	6 1/4
OL327R	12	STR	6 1/4
OL328R	14	STR	6 1/4
OL329R	16	STR	6 1/4



MB398R-MB403R



MB398R-MB403R

CONVERSE Osteotome

Catalog Number	Tip Size (mm)	Length (in.)
MB398R	2	7
MB399R	4	7
MB400R	6	7
MB401R	8	7
MB402R	10	7
MB403R	12	7



OL294R-OL300R

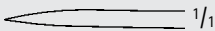

OL294R-OL300R

COTTLE Osteotome, W/ Depth Mark

Catalog Number	Tip Size (mm)	Length (in.)
OL294R	4	7
OL296R	6	7
OL298R	8	7
OL299R	10	7
OL300R	12	7



ENT
NASAL

INCHES

ENT-NASAL

Osteotomes

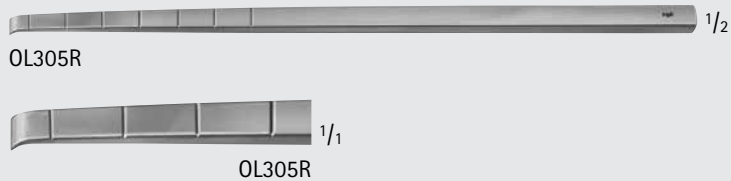

COTTLE Osteotome, Curved

Catalog Number	Tip Size (mm)	Length (in.)
OL305R	6	7

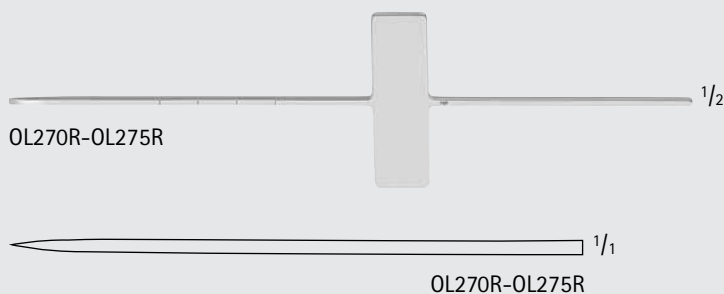

COTTLE Osteotome W/ Cross Bar

Catalog Number	Tip Size (mm)	Blade Shape	Length (in.)
OL270R	2	STR	7
OL271R	4	STR	7
OL272R	6	STR	7
OL273R	7	STR	7
OL274R	9	STR	7
OL275R	12	STR	7



TESSIER Osteotome

Catalog Number	Tip Size (mm)	Blade Shape	Length (in.)
OL360R	2.5	STR	6 1/4
OL361R	3.5	STR	6 1/4
OL362R	5	STR	6 1/4
OL366R	7	STR	6 1/4
OL368R	10	STR	6 1/4
OL370R	14	STR	6 1/4
OL371R	18	STR	6 1/4
OL363R	5	CVD	6 1/4
OL367R	7	CVD	6 1/4
OL369R	10	CVD	6 1/4

DAUTREY Osteotome

Catalog Number	Tip Size (mm)	Blade Shape	Length (in.)
OL344R	4	STR	6 3/4
OL345R	6	STR	6 3/4
OL346R	6	SLIGHTLY CVD	6 3/4
OL347R	6	STRONGLY CVD	6 3/4
OL348R	8	STR	6 3/4
OL349R	8	SLIGHTLY CVD	6 3/4
OL350R	8	STRONGLY CVD	6 3/4

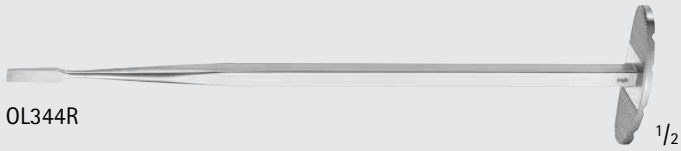

OL344R

1/2



1/16

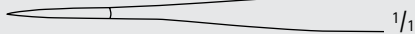

1/16

OL344R

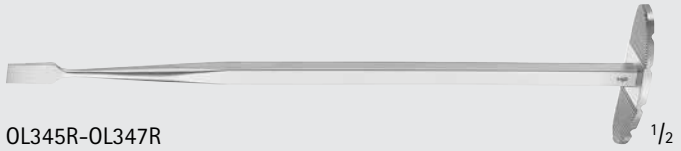

OL345R-OL347R

1/2



1/16



1/16

OL345R



1/16



1/16

OL346R



1/16

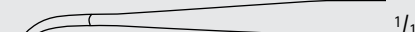

1/16

OL347R



OL348R-OL350R

1/2



1/16



1/16

OL348R



1/16



1/16

OL349R



1/16



1/16

OL350R

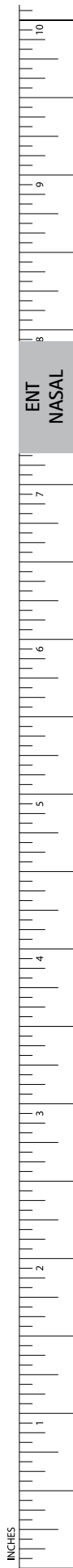

INCHES

ENT-NASAL

Osteotomes



OL338R-OL339R

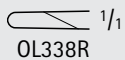

OL338R

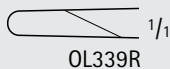

OL339R

FOMON Osteotome, Single Guard

Catalog Number	Tip Size (mm)	Length (in.)
OL338R	5	6 3/4
OL339R	8	6 3/4



OL323R



OL321R



OL322R

MASING Osteotome, Single Guard

Catalog Number	Blade	Length (in.)
OL323R	STR	6 7/8
OL321R	LEFT-CVD	6 7/8
OL322R	RIGHT-CVD	6 7/8



MA332R



MA333R



MA334R

OBEWESGESER Nasal Osteotome

Catalog Number	Tip Size (mm)	Length (in.)
MA332R	6	7 1/4
MA333R	8	7 1/4
MA334R	4	7 1/2

ENT
NASAL



MB404R-MB373R



MB404R-MB373R

Osteotome W/ Hexagonal Handle

Catalog Number	Tip Size (mm)	Length (in.)
MB404R	2	6 1/4
MB405R	3	6 1/4
MB406R	4	6 1/4
MB407R	5	6 1/4
MB408R	6	6 1/4
MB409R	7	6 1/4
MB410R	8	6 1/4
MB411R	9	6 1/4
MB412R	10	6 1/4
MB413R	11	6 1/4
MB373R	12	6 1/4



MA384R

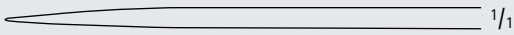

MA384R



MB388R



MB389R

RUBIN Osteotome, W/ Finger Grip

Catalog Number	Tip Size (mm)	Length (in.)
MA384R	14	6 1/4
MB388R	10	6 1/2
MB389R	14	6 1/2

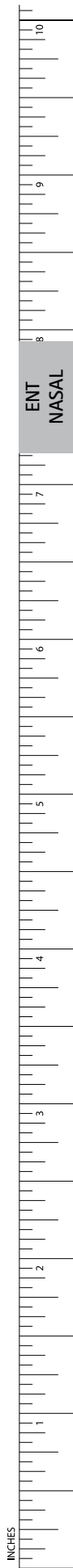

ENT-NASAL

Applicators and Probes

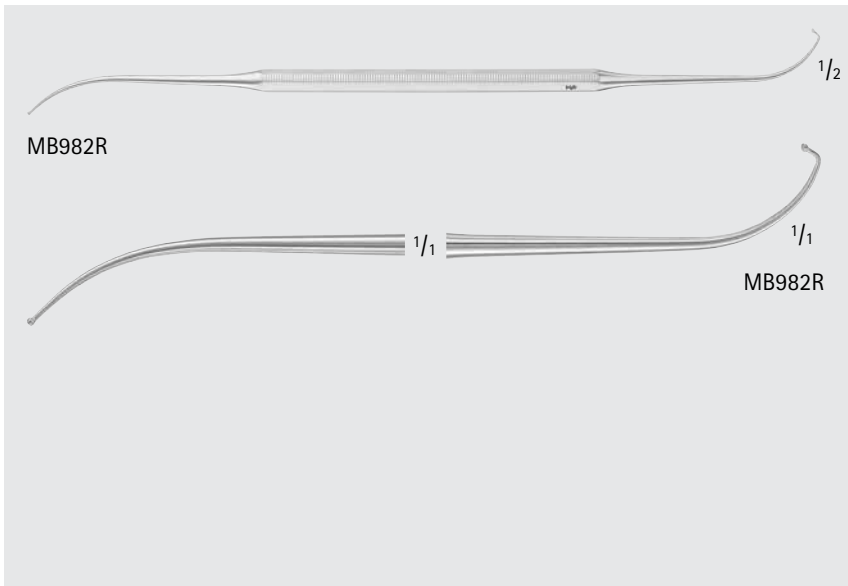
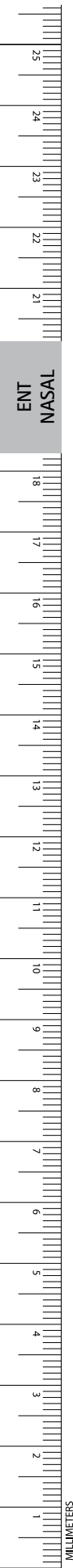

Frontal Ostium Seeker Probe, Double Ended

Catalog Number	Tip	Length (in.)
MB982R	CVD RIGHT, ANG	8 1/4

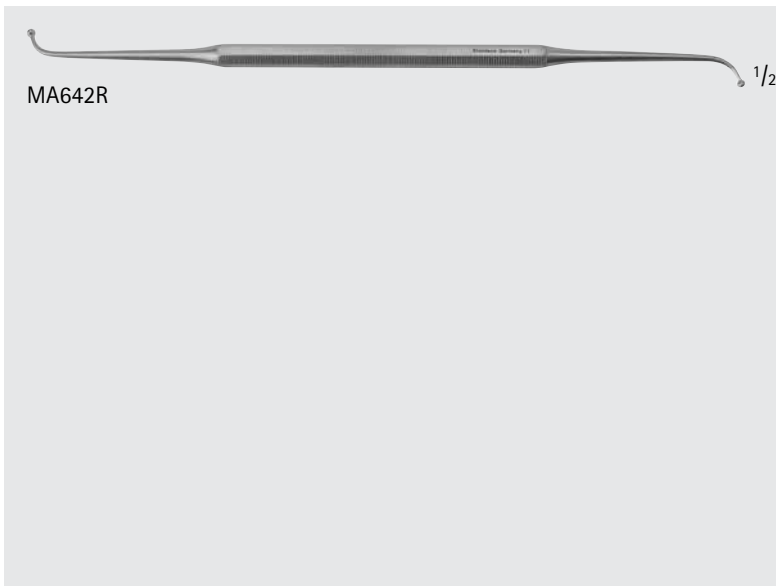

Maxillary Sinus Seeker Probe, Double Ended

Catalog Number	Tip	Tip Size (mm)	Length (in.)
MA642R	BALL	1.5 / 2	7 1/2

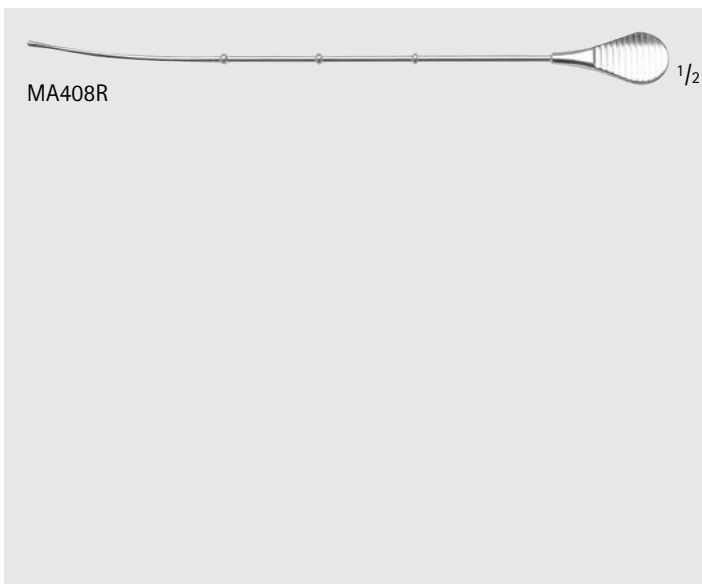

SKILLERN Sinus Probe

Catalog Number	Tip	Length (in.)
MA408R	MALLEABLE W/ BEADS AT 50, 70, AND 90 MM	6 3/4



OL354R-OL356R

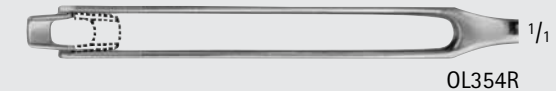

OL354R



OL355R



OL356R

BALLENGER Swivel Knife, Bayonet

Catalog Number	Blade Size (mm)	Length (in.)
OL354R	4 x 3	8 1/4
OL355R	5 x 4	8 1/4
OL356R	6 x 5	8 1/4



MA205R-MA207R



MA205R-MA207R



MB119R-MB118R



MB119R



MB118R

BALLENGER Swivel Knife, Straight

Catalog Number	Blade Width (mm)	Length (in.)
MA205R	3	7 1/2
MB119R	3	7 3/4
MB118R	4	7 3/4
MA207R	5	7 1/2



OL109R



OL109R

CONVERSE Septum Knife, Button End

Catalog Number	Blade	Length (in.)
OL109R	CVD	6



OL113R



OL113R

COTTLE Septum Knife, Round End

Catalog Number	Blade	Length (in.)
OL113R	STR	5 1/2

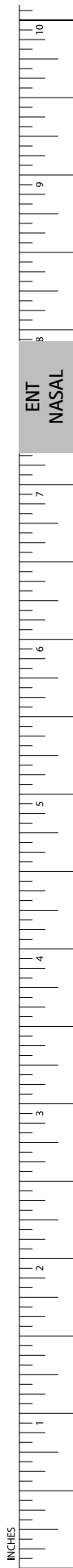

ENT-NASAL

Knives



OL120R



OL120R



MA212R



MA212R



MA211R

FREER Septum Knife

Catalog Number	Blade Shape	Blade Size (mm)	Length (in.)
OL120R	"D" SHAPED	3	6
MA212R	"D" SHAPED	3	6 1/8
MA211R	ANG	5 x 8	7



OL111R



OL111R



OL107R



OL107R

JOSEPH Knife, Button End

Catalog Number	Tip	Length (in.)
OL111R	STR	5 1/2
OL107R	CVD	6 7/8



OL102R-OL104R



OL102R



OL104R



OL104R

JOSEPH Knife, Double Edge

Catalog Number	Blade	Blade Size (mm)	Length (in.)
OL102R	STR	5 x 23	5 3/4
OL104R	CVD	5 x 23	5 3/4

ENT
NASAL



Suction Tube, Angled

Catalog Number	Tip	Tip Size (Gauge)	Length (in.)
MA010R	ANG	13	3



Nasal Suction Tube W/ Luer Hub, Tapered

Catalog Number	Tip Size (mm)	Length (in.)
GF919R	5	7

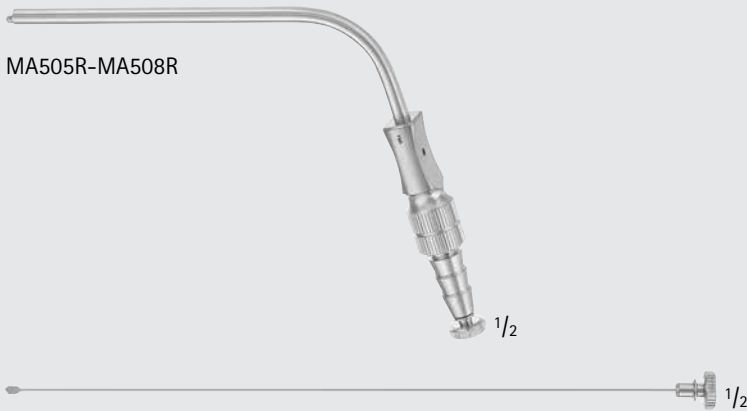

FERGUSON-FRAZIER Suction Tube

Catalog Number	Tip	Tip Size (FR)	Working Length (in.)	Length (in.)
MA505R	ANG	8	7 7/8	10 1/4
MA506R	ANG	10	7 7/8	10 1/4
MA508R	ANG	14	4	6 1/2
MA504R	ANG	14	5 7/8	8

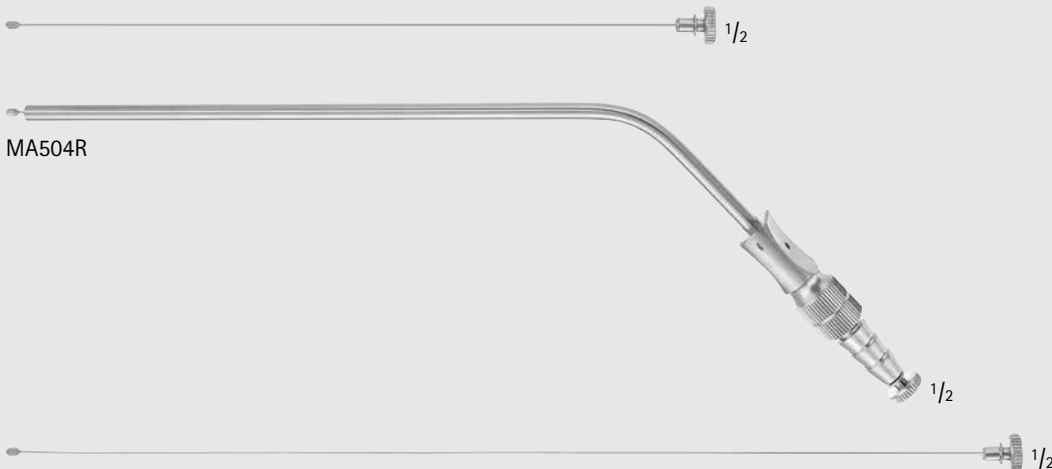

ENT-NASAL

Suction and Irrigation

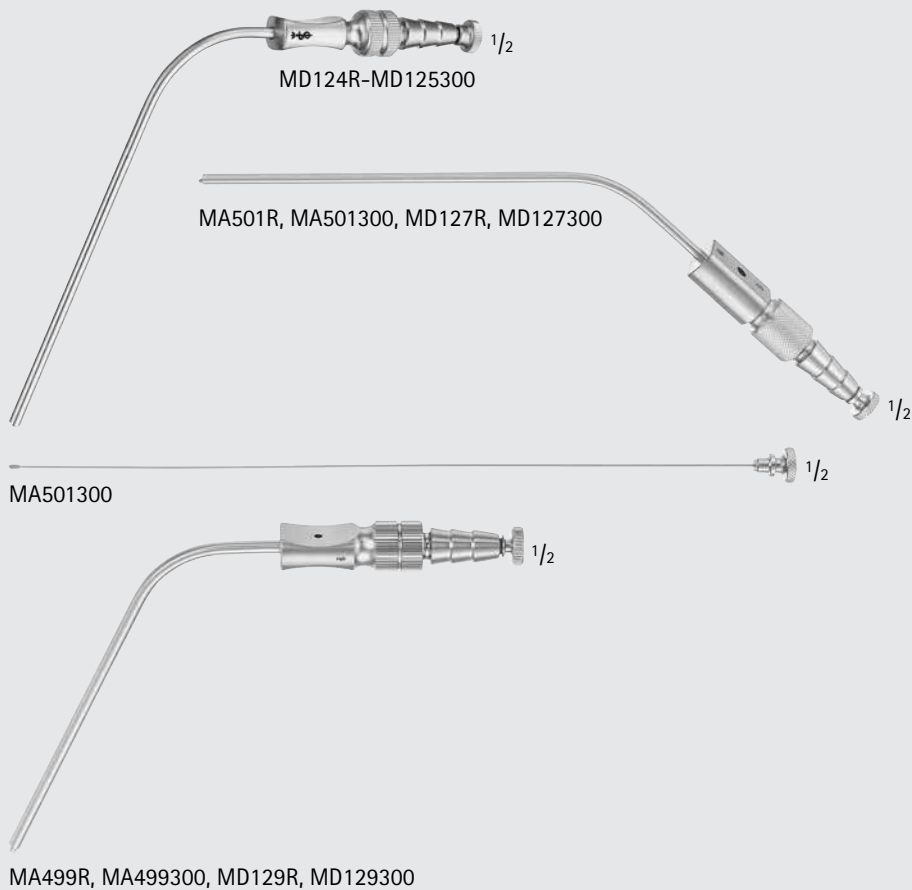

FRAZIER Suction Tube

Catalog Number	Tip Size (FR)	Description	Working Length (in.)
MD124R	7		4 1/4
MD124300	7	SUCTION STYLET W/ OLIVE TIP FOR MD124R	
MD125R	8		4 1/4
MD125300	8	SUCTION STYLET W/ OLIVE TIP FOR MD125R	
MA501R	9		4 1/4
MA501300		SUCTION STYLET W/ OLIVE TIP FOR MA501R	
MD127R	10		4 1/4
MD127300	10	SUCTION STYLET W/ OLIVE TIP FOR MD127R	
MA499R	11		4 1/4
MA499300	11	SUCTION STYLET W/ OLIVE TIP FOR MA499R	
MD129R	12		4 1/4
MD129300	12	SUCTION STYLET W/ OLIVE TIP FOR MD129R	

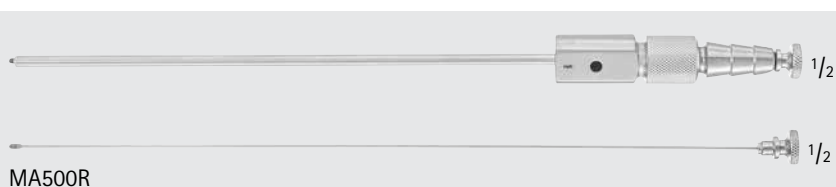

FRAZIER Suction Tube, Straight

Catalog Number	Tip	Working Length (in.)	Length (in.)
MA500R	STR	5 1/2	6 7/8



FRAZIER Suction Tube W/ Luer Hub

Catalog Number	Tip Size (FR)	Length (in.)
GF923R	9	7
GF925R	15	7

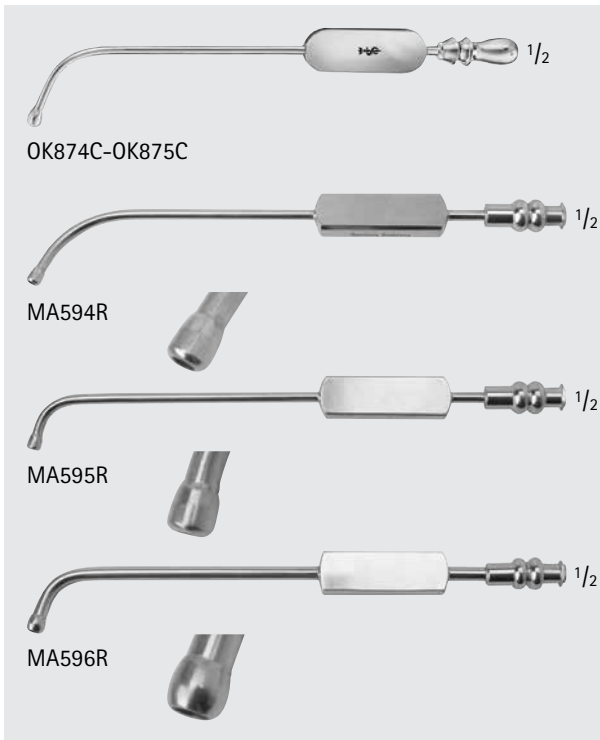

EICKEN Antrum Suction Tube, Bulbous

Catalog Number	Tip	Diameter (mm)	Length (in.)
OK874C	SMALL	2.5	5 1/8
OK875C	LARGE	3	5 1/8
MA594R	LONG CURVE	3	5 5/8
MA595R	SHORT CURVE	3	5 5/8
MA596R	SHORT CURVE	4	5 5/8

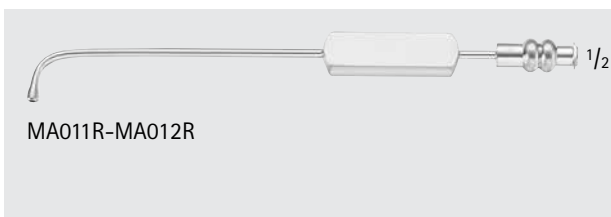

KILLIAN Antrum Cannula

Catalog Number	Tip Size	Tip Size (#)	Length (in.)
MA011R	SMALL	1	5
MA012R	LARGE	2	5

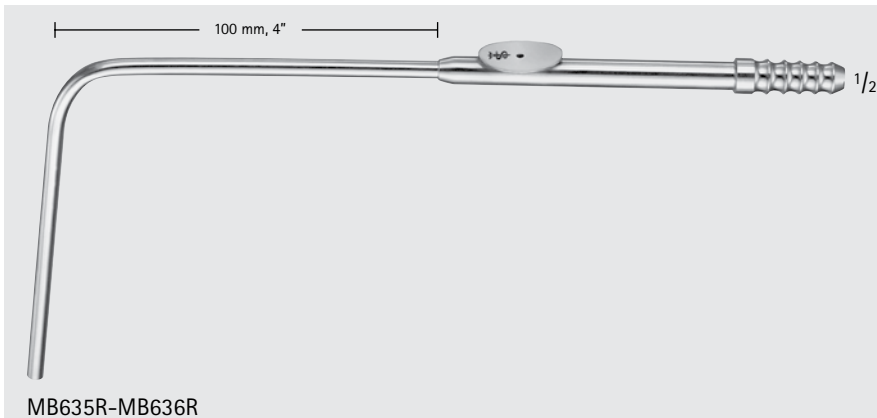

SACHS Suction Tube

Catalog Number	Tip Size	Length (in.)
MB635R	SMALL	8 1/2
MB636R	LARGE	8 1/2



ENT-NASAL

Suction and Irrigation



GORNEY Suction Dissector, Elevator

Catalog Number	Tip Size (mm)	Length (in.)
OL168R	6-10	7
MA142R	3	8 1/2



MA142R



HAJEK Irrigating Cannula

Catalog Number	Diameter (mm)	Length (in.)
OK900	3.5	6 1/2

OK900



HOUSE Cutoff Adapter

Catalog Number	Tip	Tip Size (mm)
MA607R	TUBING END	4

MA607R

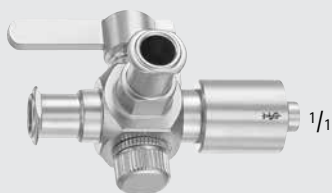

Stopcock Luer Adapter, Female to Male

Catalog Number	Description
MA716R	FEMALE TO MALE LUER LOCK W/ FEMALE RIGHT

MA716R



Luer Adapter

Catalog Number	Description
MA715R	MALE LUER LOCK-TO-HOSE

MA715R

ENT
NASAL

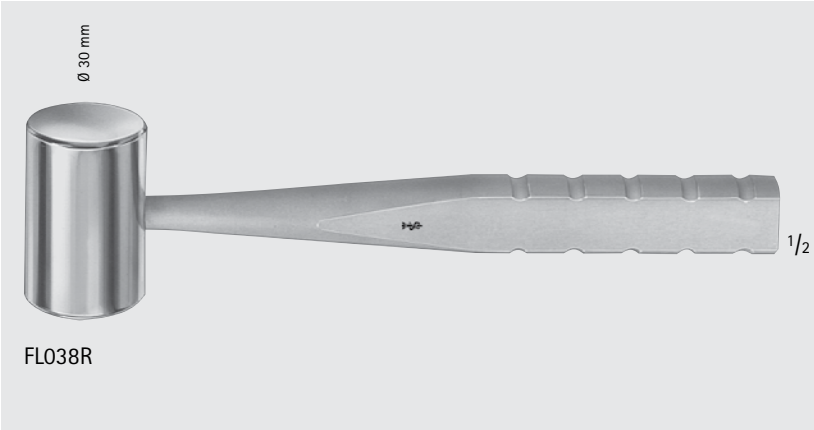

COTTLE Mallet, Flat/Round, 235gr

Catalog Number	Diameter (mm)	Length (in.)
FLO38R	30	7 1/4

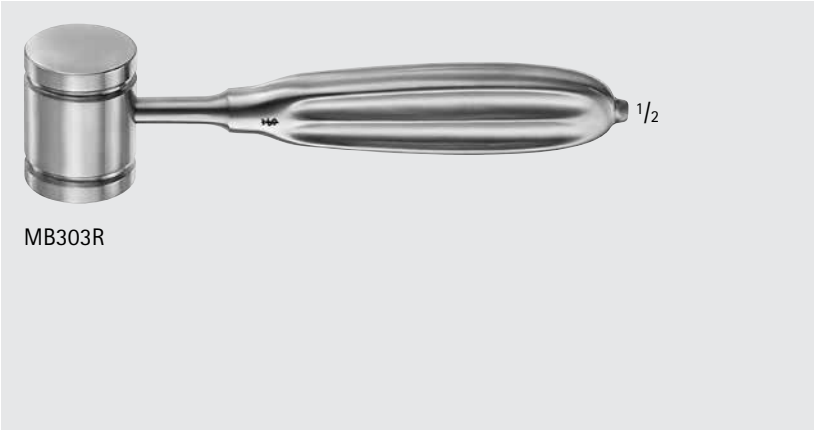

CRANE Mallet

Catalog Number	Diameter (mm)	Length (in.)
MB303R	32	6 1/4

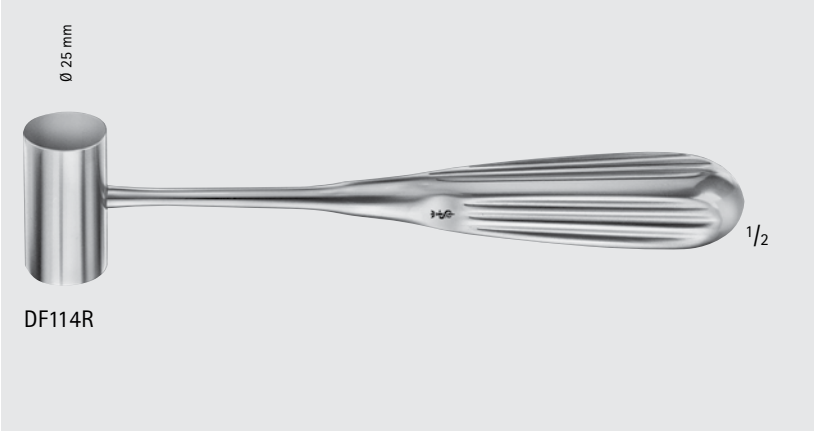

Mallet, 155gr

Catalog Number	Diameter (mm)	Length (in.)
DF114R	25	7 1/2

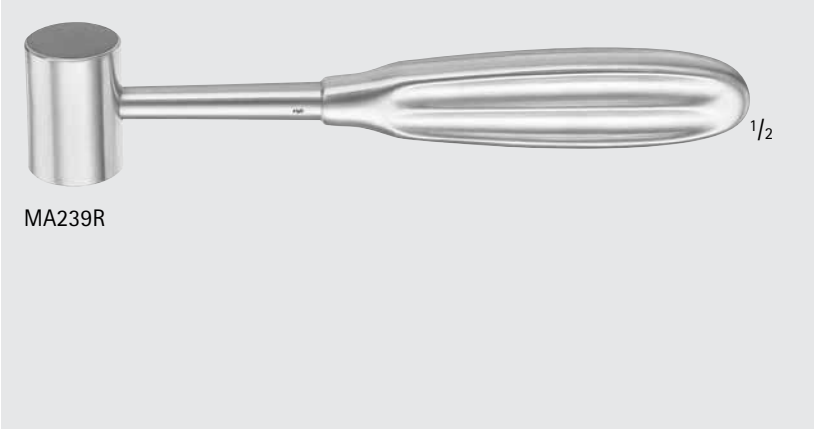

Lead Mallet

Catalog Number	Diameter (mm)	Handle	Description	Length (in.)
MA239R	25	LARGE	LEAD FILLED	7 1/16

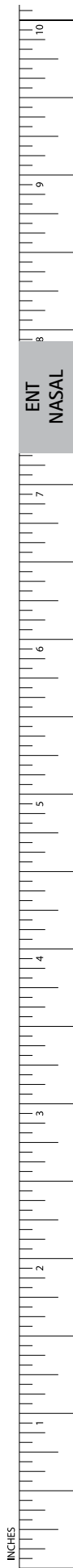

ENT-NASAL

Mallets, Hammers and Tamps

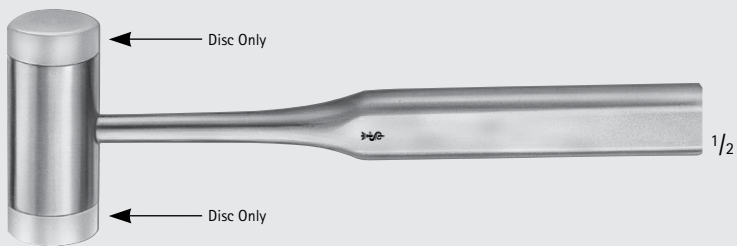

FL036R-FL037

Mallet W/ Removable Nylon Discs, 135gr

Catalog Number	Description	Diameter (mm)	Length (in.)
FL036R	COMPLETE	25	7 1/4
FL037	NYLON SPARE DISCS, F/FL036R, 2/SET	25	

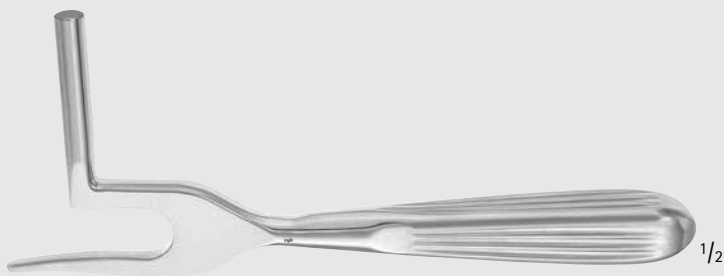

MA338R

QUISLING Intranasal Hammer

Catalog Number	Length (in.)
MA338R	6 3/4



FL093R-FL096R

Bone Tamp

Catalog Number	Diameter (mm)	Length (in.)
FL093R	3	6 1/4
FL094R	5	6 1/4
FL095R	7	6 1/4
FL096R	9	6 1/4



FL093R



FL094R



FL095R



FL096R



MA589R-MA593R



MA589R



MA588R



MA592R



MA593R



FK651R-FK654R



FK651R



FK652R

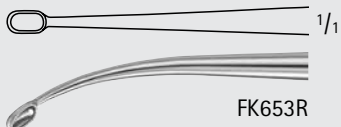

FK653R

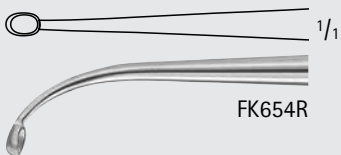

FK654R



MA591R



MA591R



MA590R



MA590R

Antrum Curette

Catalog Number	Tip	Tip Size (mm)	Length in.)
MA589R	OBLONG	-	7 1/2
MA588R	OVAL CUP	7 x 11	7 1/2
MA592R	OVAL CUP	8 x 11	7 1/2
MA593R	OVAL CUP	9 x 13	7 1/2
FK651R	OVAL CUP, ANG	9.5 x 4	7 1/2
FK652R	OVAL CUP, ANG	6 x 3	7 1/2
FK653R	55° CVD	6 x 3	7 1/2
FK654R	90° CVD	6 x 3	7 1/2
MA591R	BACKWARD CUTTING	7 x 10	7 1/2
MA590R	FORWARD CUTTING	7 x 10	7 1/2



ENT
NASAL

INCHES

ENT-NASAL

Curettes



FK817R



FK817R

BARTH Bone Curette, Double Ended

Catalog Number	Tip Size (mm)	Length (in.)
FK817R	2.3 x 6.0 / 2.7 x 7.0	7



OK811R-OK816R

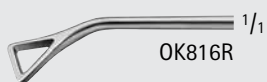

COAKLEY Antrum Curette

Catalog Number	Blade	Size (#)	Length (in.)
MB799R	-	SET OF 6 INCLUDES OK811R- OK816R	-
OK811R	SLIGHT ANG	1	6 3/4
OK812R	45°	2	6 3/4
OK813R	REV ANG	3	6 3/4
OK814R	SLIGHT ANG	4	6 3/4
OK815R	45°	5	6 3/4
OK816R	45°	6	6 3/4

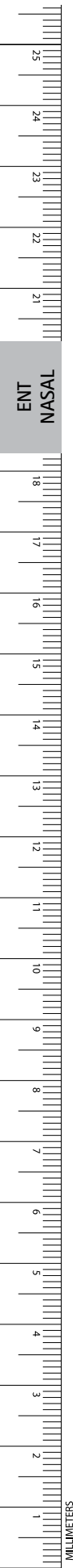



FK813R

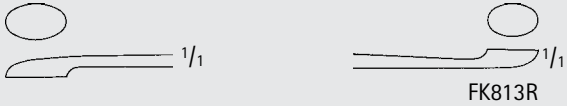

JACOBSON Bone Curette, Double Ended

Catalog Number	Tip Size (mm)	Length (in.)
FK813R	4.3 x 6.5 / 4.5 x 8.5	5 1/2



FK803R

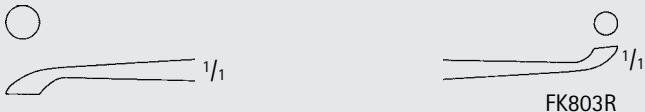

JANSEN Bone Curette, Double Ended

Catalog Number	Diameter (mm)	Length (in.)
FK803R	4.3 / 3.6	6 1/4



FK840R

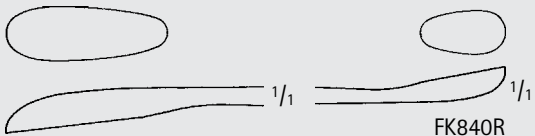

VOLKMANN Bone Curette, Double Ended

Catalog Number	Tip Size (mm)	Length (in.)
FK840R	7.5 x 21.0 / 6.0 x 11.0	5 1/8
FK842R	7.5 x 21.0 / 6.0 x 11.0	6 3/4



FK842R

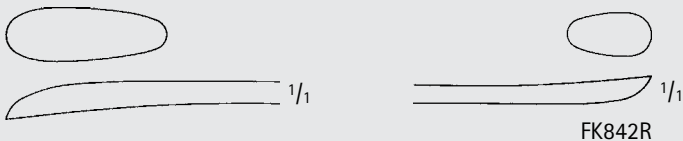

FK814R

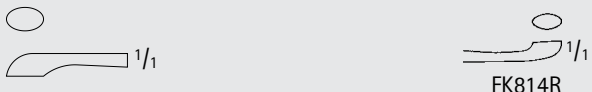

WILLIGER Bone Curette, Double Ended

Catalog Number	Tip Size (mm)	Length (in.)
FK814R	2.0 x 3.5 / 3.0 x 4.5	5 3/4

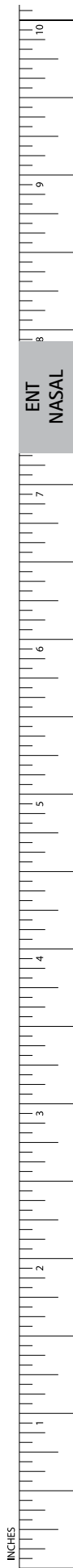

ENT-NASAL

Curettes

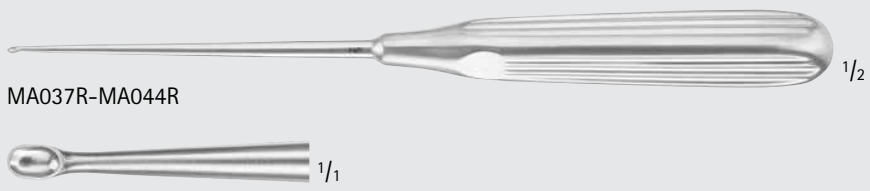

LEMPERT Bone Curette

Catalog Number	Size (#)	Length (in.)
MA037R	000000	8
MA038R	00000	8
MA039R	0000	8
MA044R	2	8

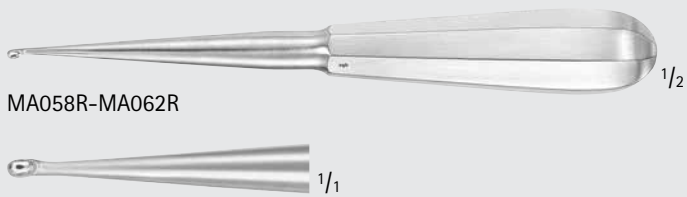
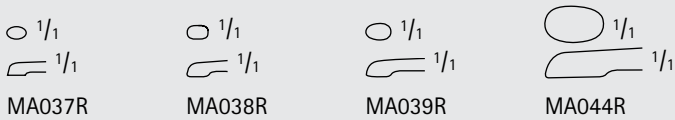

SPRATT Mastoid Curettes

Catalog Number	Tip Size (mm)	Size (#)	Length (in.)
MA058R	2.5 x 4	00	6 1/2
MA059R	3 x 5	0	6 1/2
MA060R	3.5 x 6	1	6 1/2
MA061R	4.5 x 8	3	6 1/2
MA062R	5.5 x 9	4	6 1/2

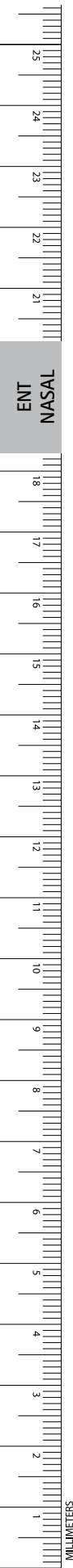
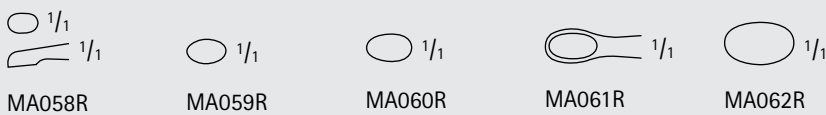

ALEXANDER Bone Rongeur

Catalog Number	Jaw Size (mm)	Jaw	Length (in.)
FO440R	3.2 x 27	ANG	5 1/2



FO440R



FO440R

BANE-HARTMANN Bone Rongeur

Catalog Number	Jaw Size (mm)	Jaw	Length (in.)
FO457R	4.0 x 32	CVD	6 7/8

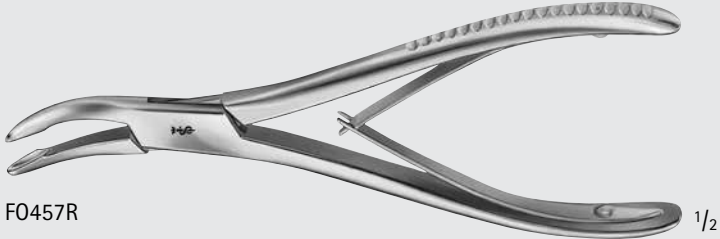

FO457R



FO457R

BEYER Bone Rongeur

Catalog Number	Jaw Size (mm)	Jaw	Handle	Length (in.)
FO453R	3.2 x 32	CVD	Single Action	7
FO514R	4.0 x 30	CVD	Double Action	7

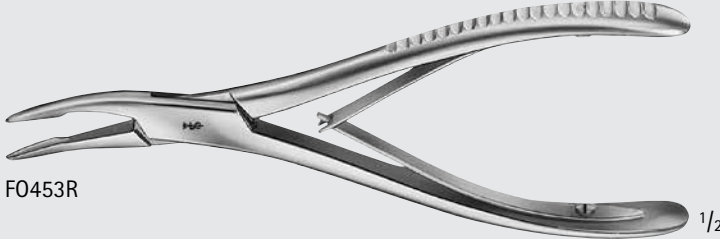

FO453R



FO453R



FO514R

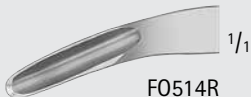

FO514R

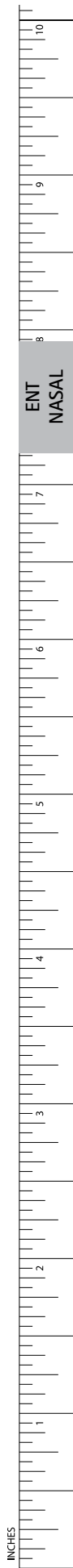

ENT-NASAL

Rongeurs

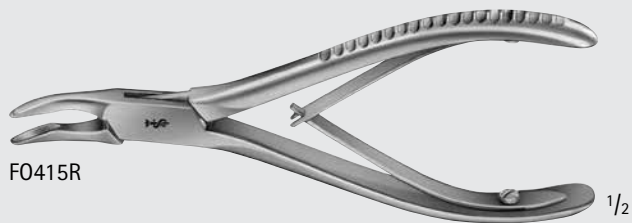

FO415R



FO415R

BLUMENTHAL Bone Rongeur

Catalog Number	Jaw Size (mm)	Jaw	Length (in.)
FO415R	3.5 x 25	CVD	6 1/8

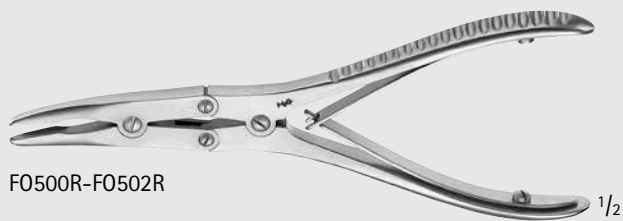

FO500R-FO502R



FO500R



FO502R

BOEHLER Bone Rongeur, Double Action

Catalog Number	Jaw Size (mm)	Jaw	Jaw End	Length (in.)
FO500R	3.0 x 27	CVD	NARR	6 1/8
FO502R	3.5 x 30	CVD	WIDE	6 1/8

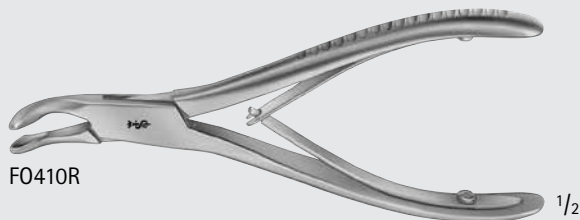

FO410R



FO410R

Bone Rongeur

Catalog Number	Jaw Size (mm)	Jaw	Length (in.)
FO410R	3.8 x 19	CVD	5 1/2

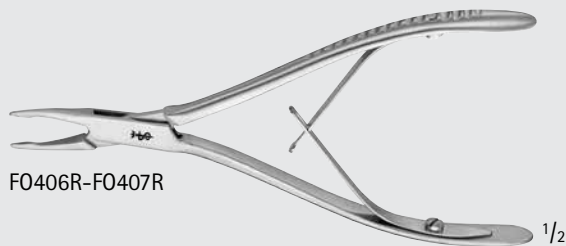

FO406R-FO407R



FO406R



FO407R

FRIEDMANN Micro Rongeur

Catalog Number	Jaw Size (mm)	Jaw	Length (in.)
FO406R	1.3 x 19	STR	5 1/2
FO407R	1.3 x 20	CVD	5 1/2

JANSEN Bone Rongeur

Catalog Number	Jaw Size (mm)	Jaw	Length (in.)
FO430R	4.2 x 35	STR	6 7/8
FO432R	4.5 x 30	CVD	6 7/8
FO442R	3.8 x 37	ANG	7 1/2

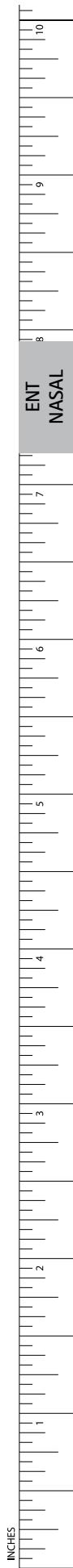
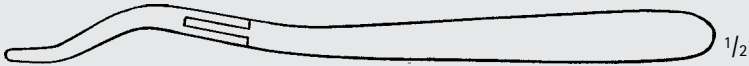

ENT-NASAL

Rongeurs

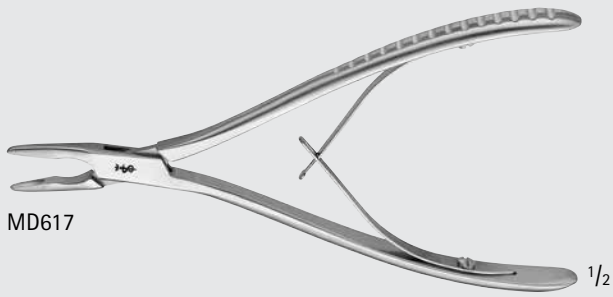

MD617

1/2



MD617

1/1

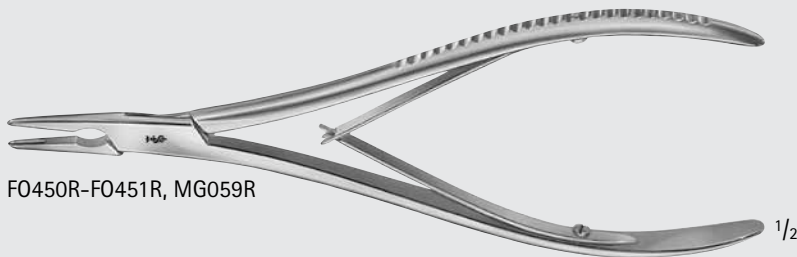

FO450R-FO451R, MG059R

1/2



FO450R

1/1



MG059R

1/1



FO451R

1/1

LEMPERT Bone Rongeur

Catalog Number	Jaw Size (mm)	Jaw	Length (in.)
MD617	2.0 x 23	DEL, STR	6 1/2
FO450R	2.2 x 27	STR	7 7/8
MG059R	2.5 x 30	CVD	6 1/4
FO451R	2.2 x 27	CVD	7 7/8

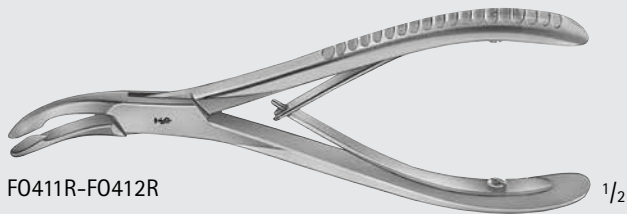

FO411R-FO412R

1/2



FO411R

1/1

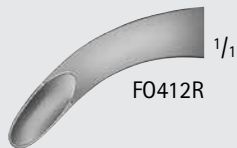

FO412R

1/1

LUER Bone Rongeur

Catalog Number	Jaw Size (mm)	Jaw	Length (in.)
FO411R	4.2 x 20	CVD	6
FO412R	4.2 x 26	STRONG CVD	6 1/8

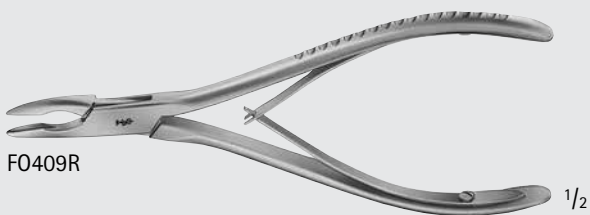

FO409R

1/2



FO409R

1/1

LUER-FRIEDMANN Bone Rongeur

Catalog Number	Jaw Size (mm)	Jaw	Length (in.)
FO409R	2.2 x 22	CVD	5 3/4

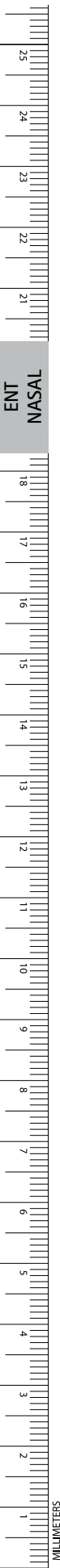

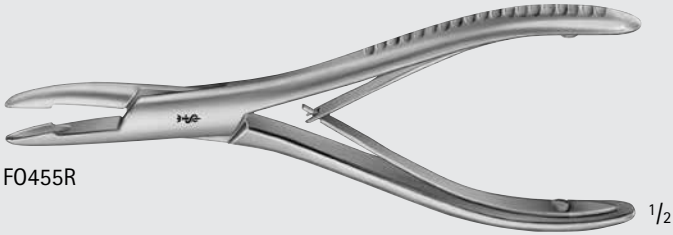

FO455R

1/2



1/1

FO455R

MEAD Bone Rongeur

Catalog Number	Jaw Size (mm)	Jaw	Length (in.)
FO455R	3.5 x 30	CVD	6 1/2



FO515R

1/2



1/1

FO515R

ZAUFAL-JANSEN Bone Rongeur, Double Action

Catalog Number	Jaw Size (mm)	Jaw	Length (in.)
FO515R	4.5 x 29	CVD	7

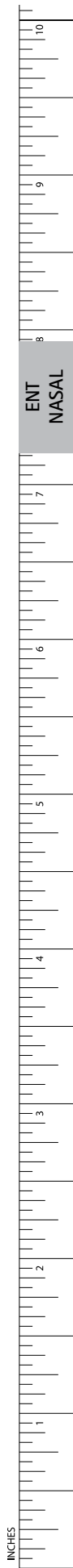

INCHES

ENT-NASAL

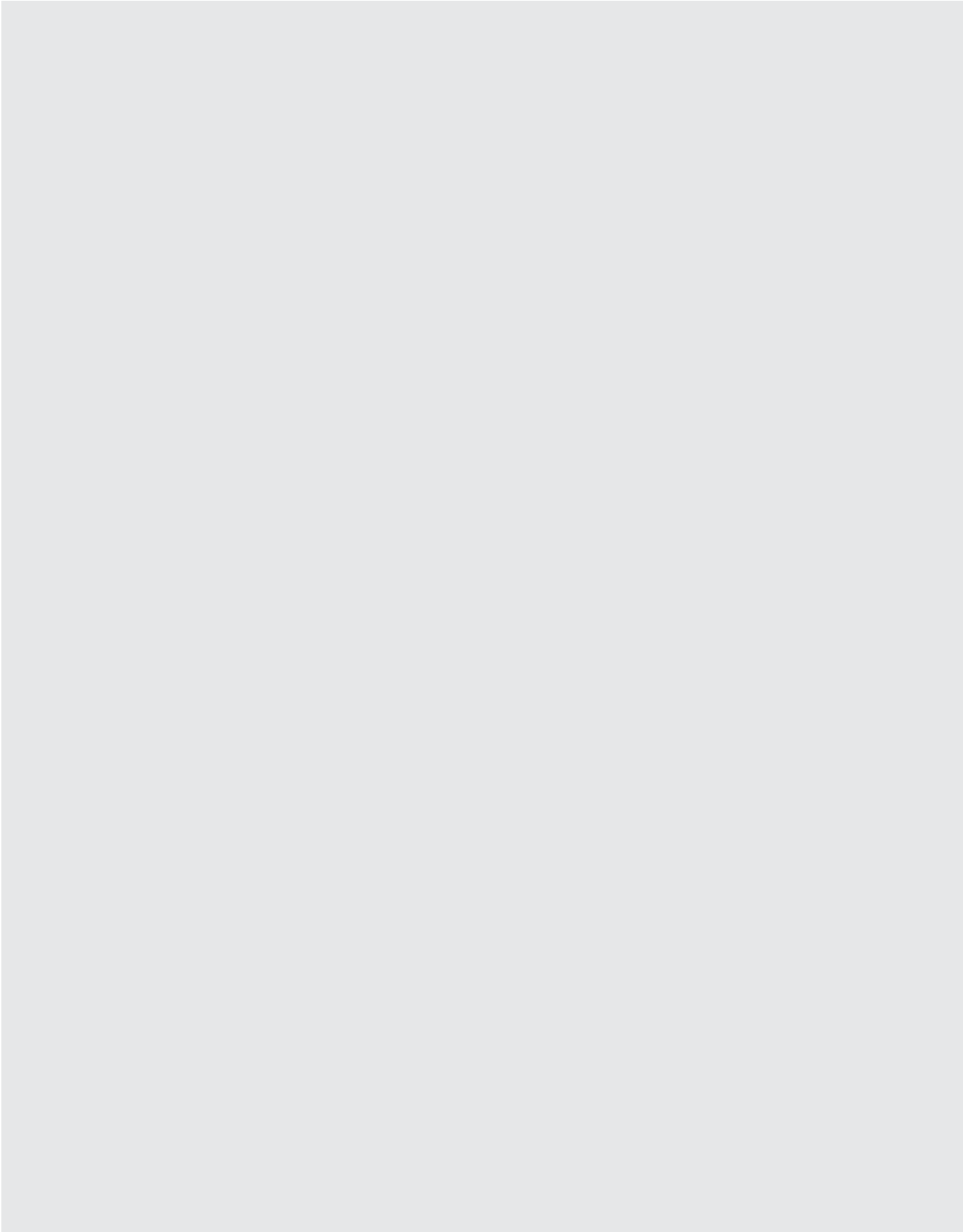
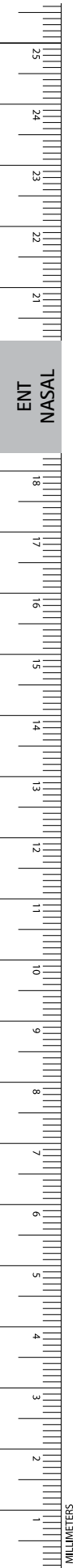



ENT-ORAL

Scissors	706 - 708
Needles	709
Forceps	709 - 712
Clamps	713 - 719
Tracheal Dilators / Hooks / Retractors	720 - 721
Retractors	722 - 724
Tonsil Dissectors	725
Adenotomes, Tonsil Snares and Wires	726 - 728
Mouth Gags	729 - 737
Tonsil Knives	738
Suction Tubes	739
Adenoid Currettes	740 - 742
Syringes	743
Laryngeal Mirrors	744
Amalgam Carriers	745

ENT-ORAL

Oral Scissors

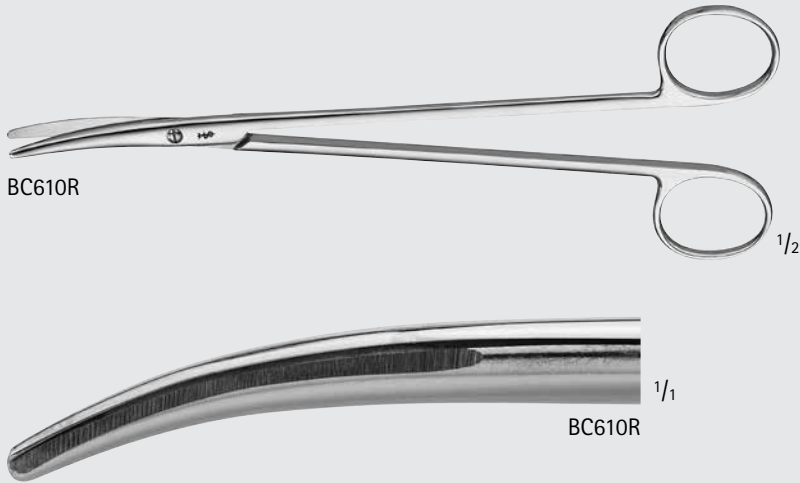

LILLIE Dissecting Scissors

Catalog Number	Tip	Blade	Length (in.)
BC610R	B/B	CVD	7 7/8

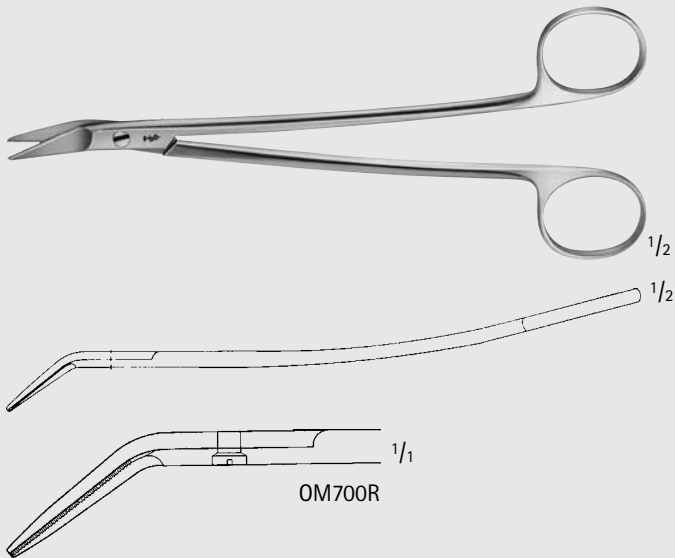

DEAN Tonsil Scissors

Catalog Number	Tip	Blade	Length (in.)
OM700R	B/B	ANG-SERR	6 3/4

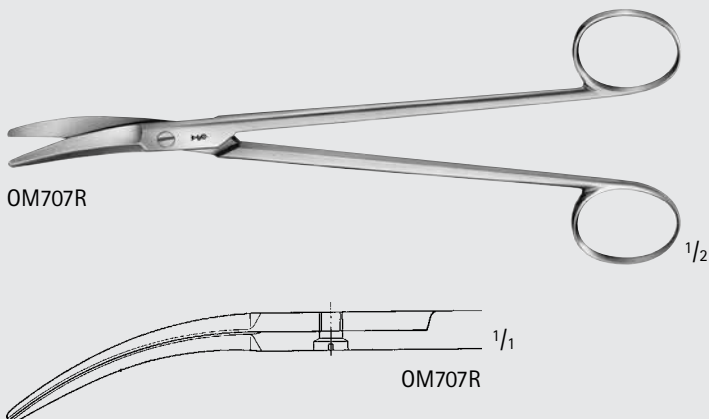

BOETTCHER Tonsil Scissors

Catalog Number	Tip	Blade	Length (in.)
OM707R	B/B	CVD	7

ENT
ORAL

MILLIMETERS

BROPHY Gum Scissors

Catalog Number	Tip	Blade	Length (in.)
MA445R	S/S	CVD	5 1/2

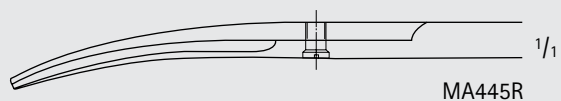
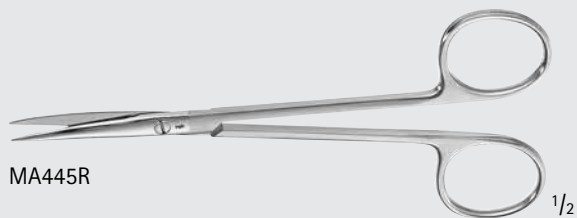

DUROTIP™ Tungsten Carbide Scissors

- Excellent cutting accuracy
- Long working life
- Gold-plated rings

DUROTIP TC Gum Scissors, Delicate

Catalog Number	Tip	Blade	Length (in.)
DO208R	S/S	STR	4 3/4
DO209R	S/S	CVD	4 3/4

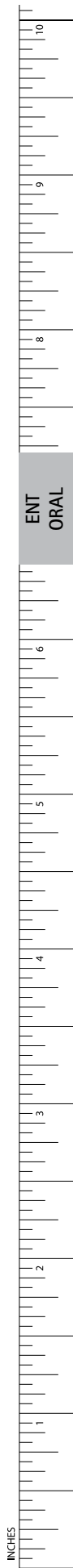
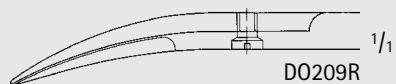
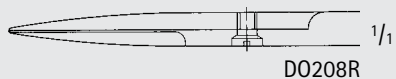
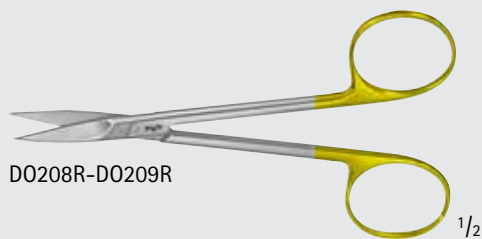

INCHES

ENT-ORAL

Laryngeal Scissors

Micro Laryngeal Scissors, W/ Flush Port

Catalog Number	Tip	Blade	Working Length (in.)
OP310R	S/S	STR	9 3/4
OP311R	S/S	CVD-LEFT	9 3/4
OP312R	S/S	CVD-RIGHT	9 3/4
OP313R	S/S	ANG-UP	9 3/4

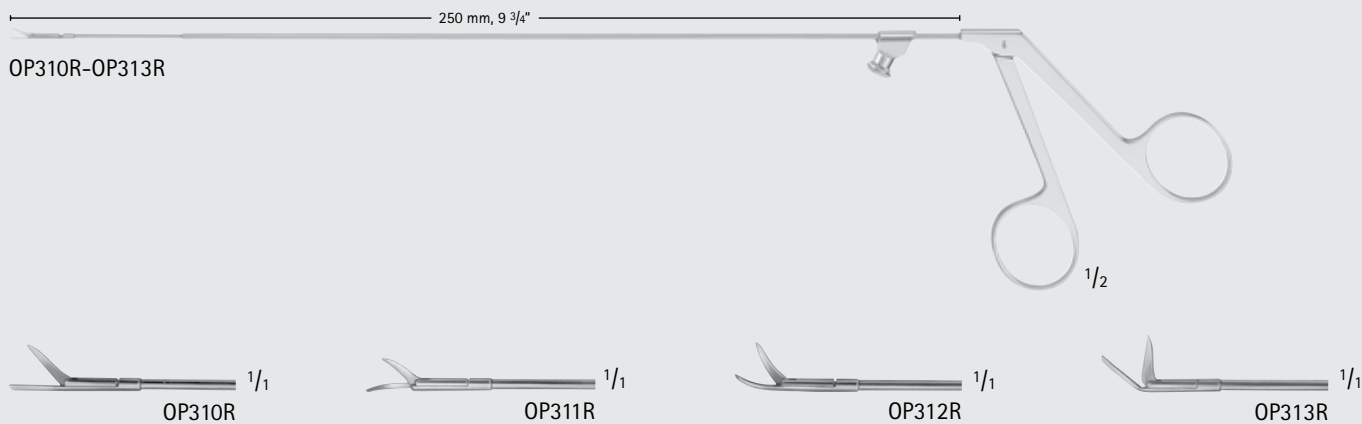

KLEINSASSER Micro Scissors

Catalog Number	Tip	Blade	Blade Size (mm)	Working Length (in.)
MA460R	B/B	STR	4	14

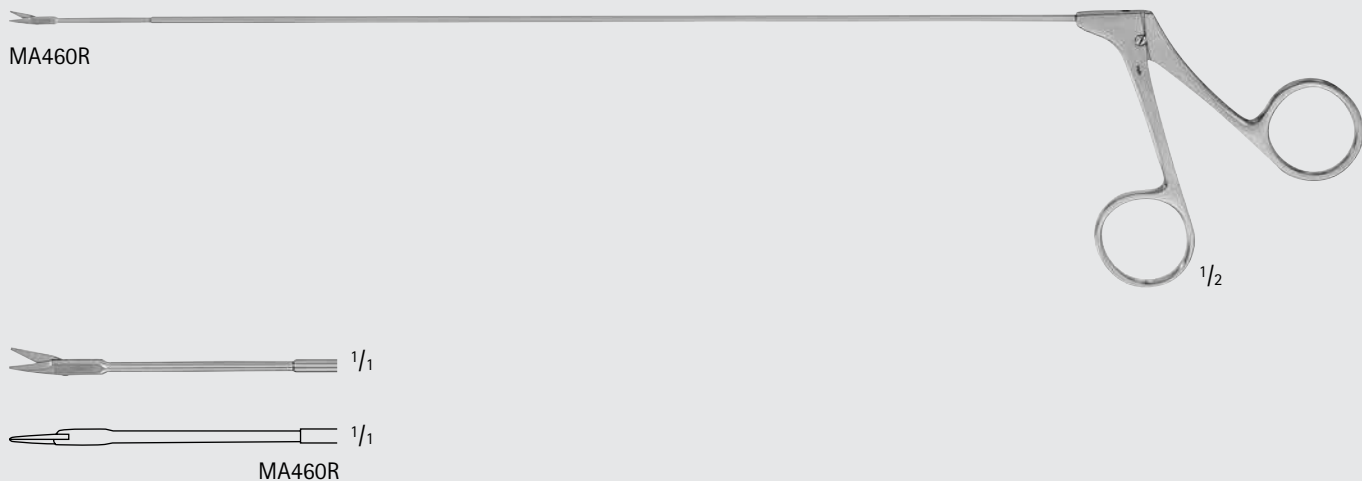

ENT
ORAL

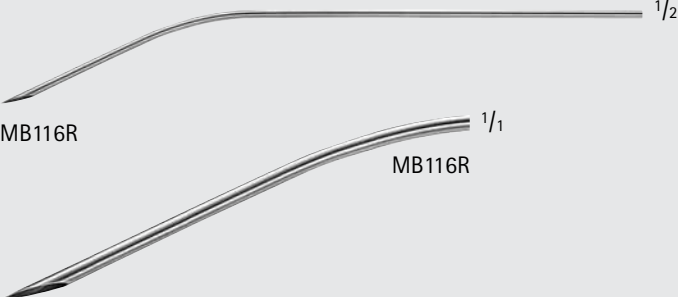

MB116R $\frac{1}{2}$

MB116R $\frac{1}{1}$

DINGMAN Wire Passing Needle

Catalog Number	Tip	Length (in.)
MB116R	CVD	6 $\frac{3}{4}$

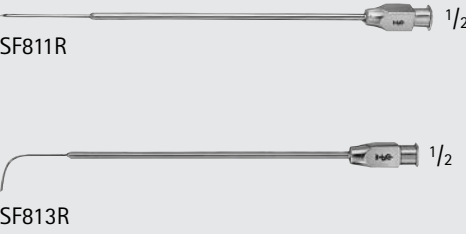

SF811R $\frac{1}{2}$

SF813R $\frac{1}{2}$

Tonsil Needle, 23 Gauge

Catalog Number	Tip	Tip Size (mm)	Length (in.)
SF811R	STR	DIAM. 0.8	3
SF813R	CVD	DIAM. 0.8	3

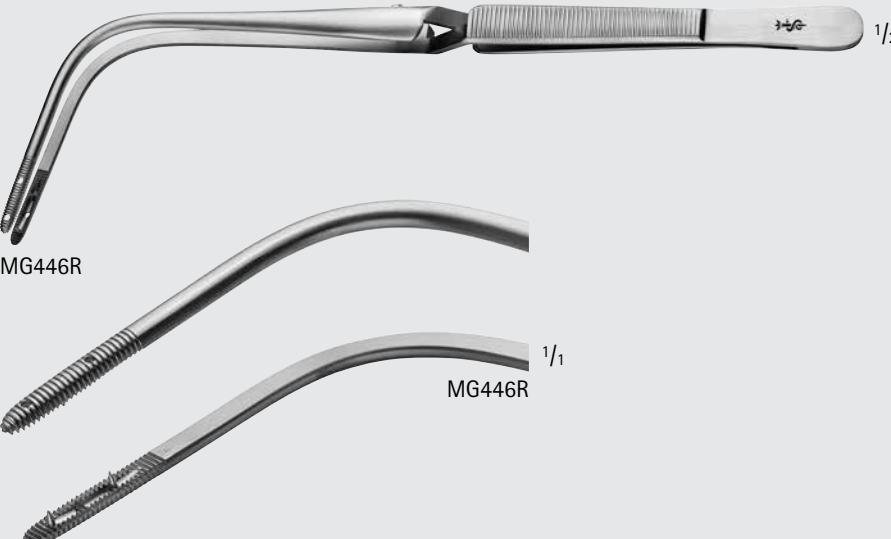

MG446R $\frac{1}{2}$

MG446R $\frac{1}{1}$

JACKSON Laryngeal Self-Closing Dressing Forceps

Catalog Number	Tip	Teeth	Length (in.)
MG446R	SERR	1 x 2	9



ENT
ORAL

INCHES

ENT-ORAL

Forceps

Laryngeal Forceps, W/ Flush Port

Catalog Number	Jaw	Working Length (in.)
OP300R	STR	9 3/4
OP301R	CVD-LEFT	9 3/4
OP302R	CVD-RIGHT	9 3/4

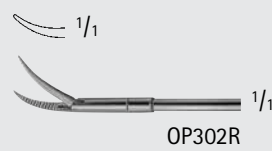
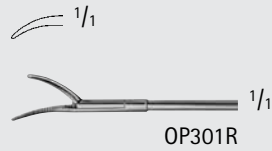
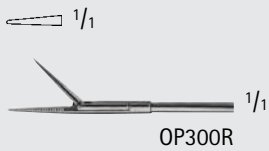
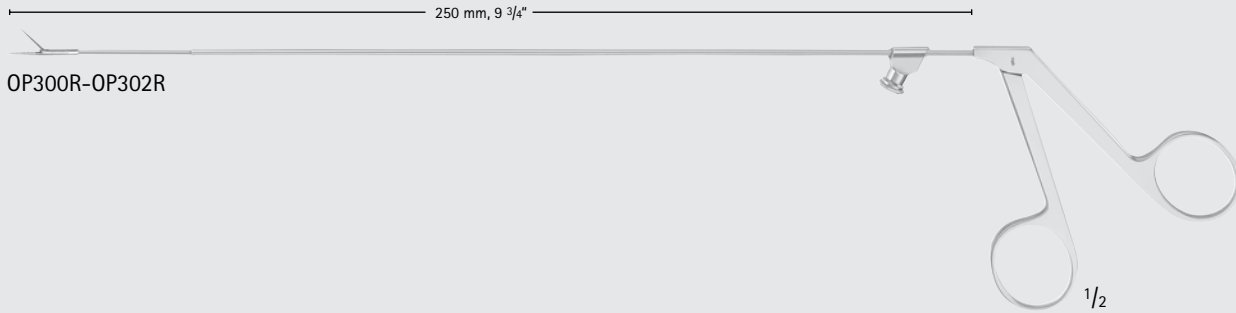

Micro Laryngeal Cup Forceps, W/ Flush Port

Catalog Number	Cup Size (mm)	Jaw	Working Length (in.)
OP304R	2	STR	9 3/4
OP305R	2	ANG-LEFT	9 3/4
OP306R	2	ANG-RIGHT	9 3/4
OP307R	2	ANG-UP	9 3/4

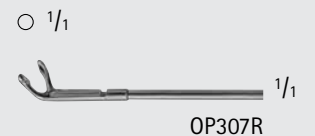
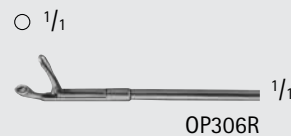
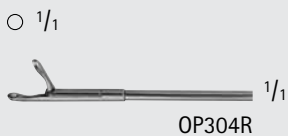
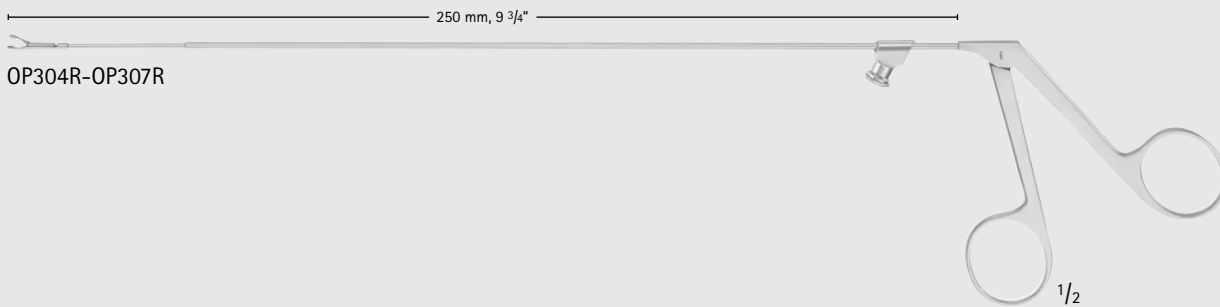

ENT
ORAL

Alligator Grasping Forceps

Catalog Number	Tip	Tip Size (mm)	Working Length (in.)	Length (in.)
MA663R	SERR	8.8 x 4	11	13 3/4

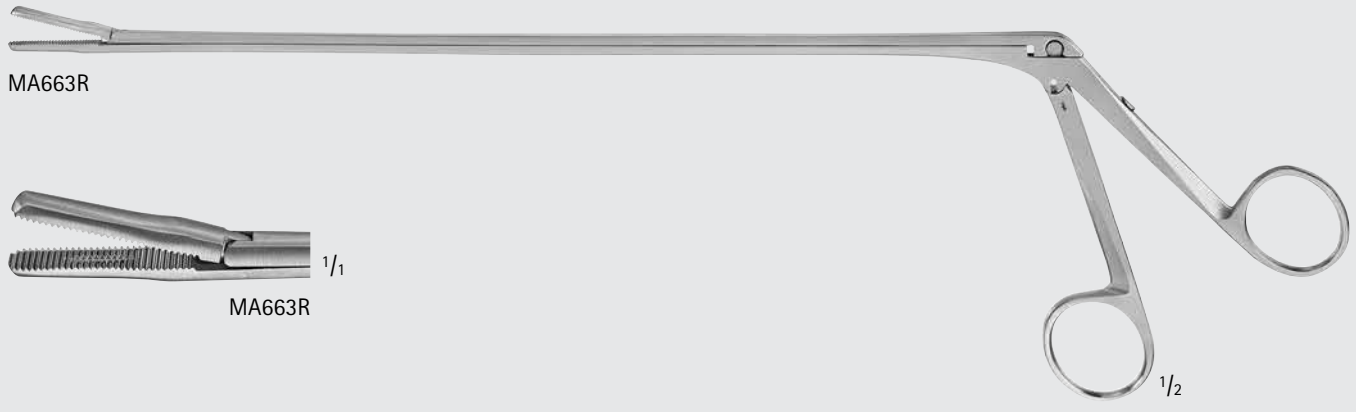

INCHES

ENT-ORAL

Forceps

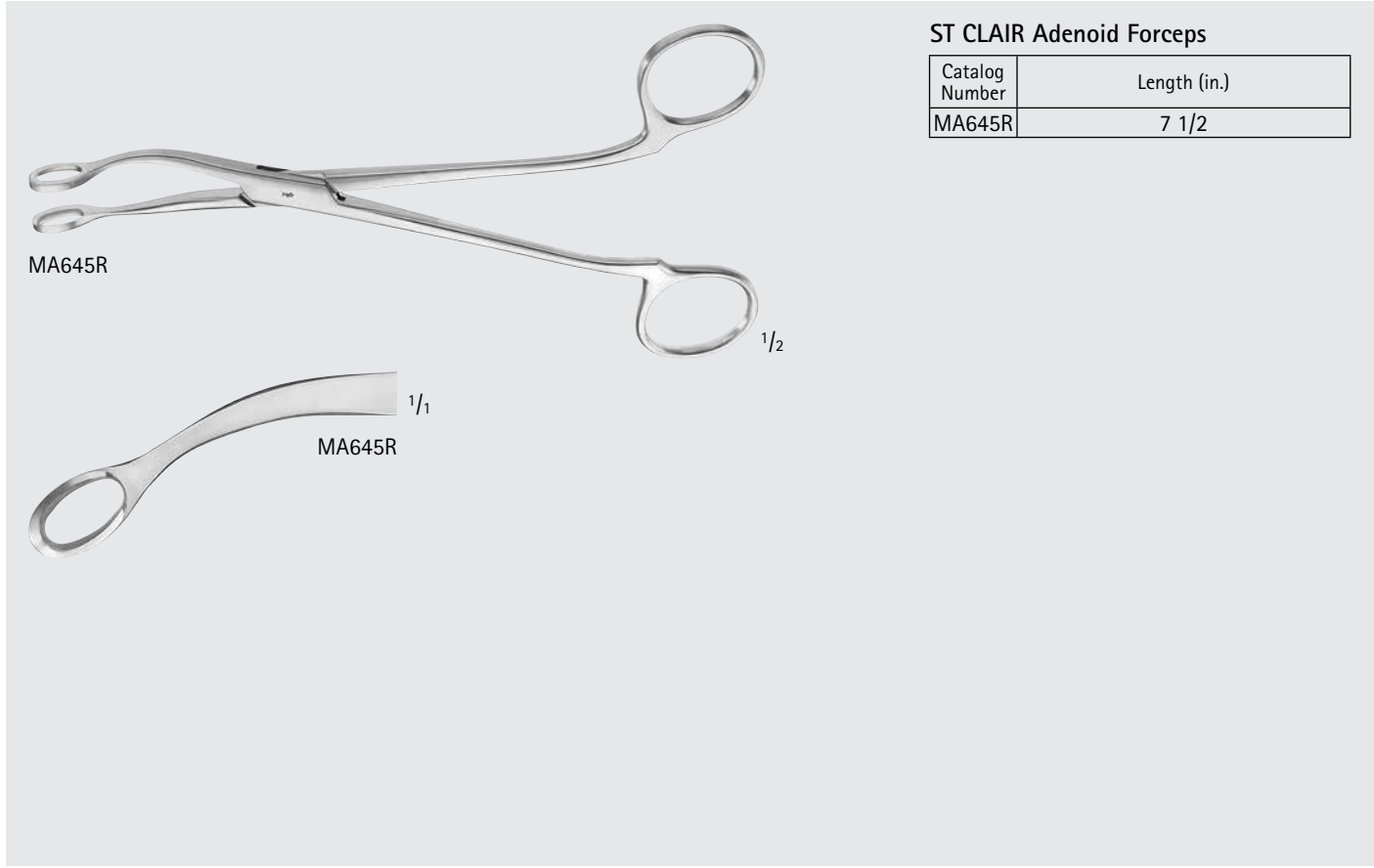
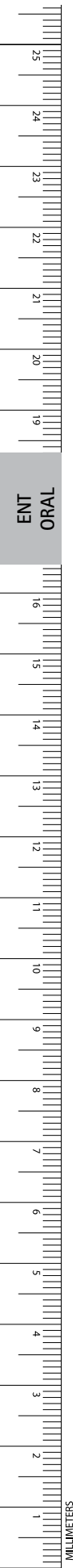

ST CLAIR Adenoid Forceps

Catalog Number	Length (in.)
MA645R	7 1/2

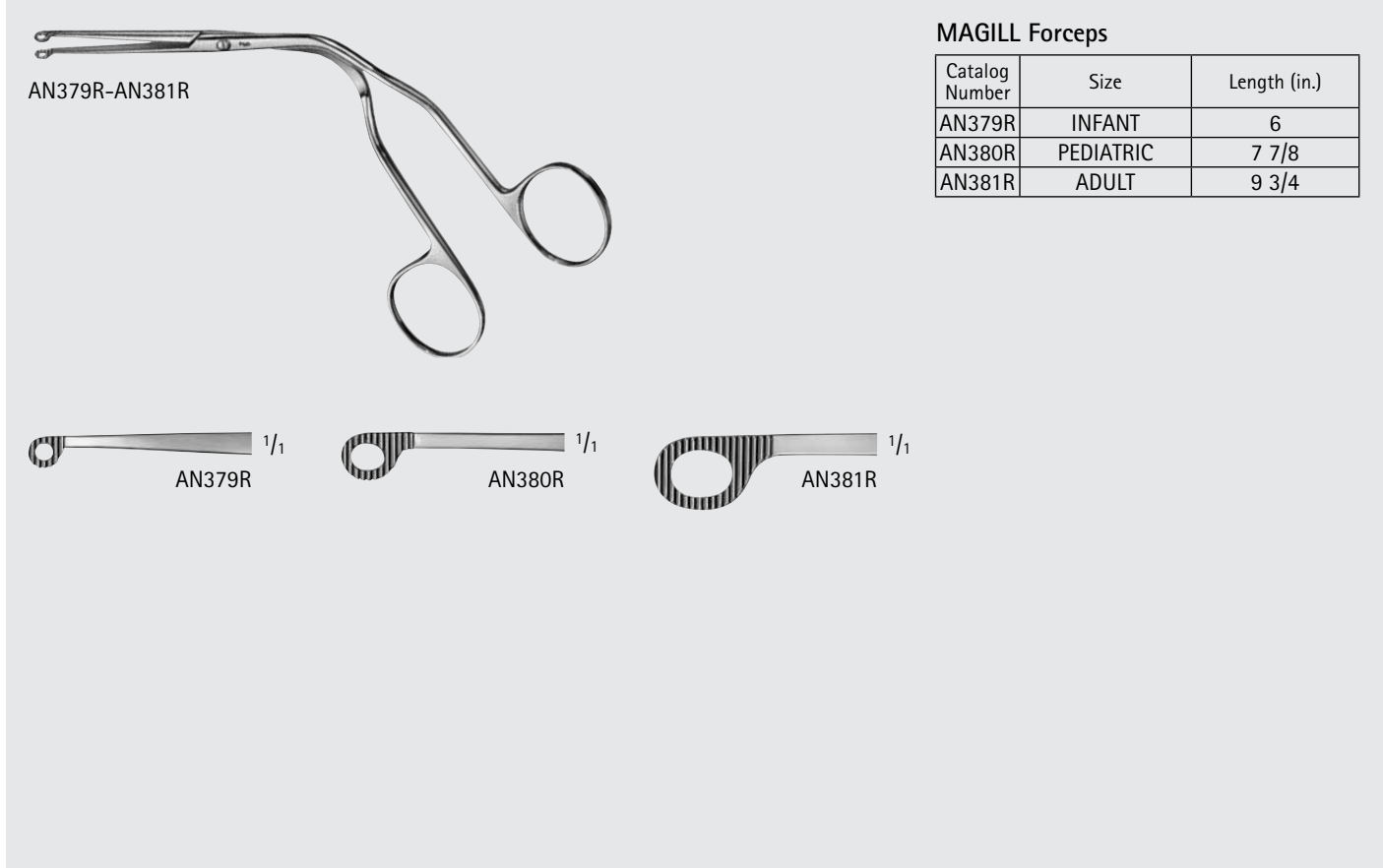

MAGILL Forceps

Catalog Number	Size	Length (in.)
AN379R	INFANT	6
AN380R	PEDIATRIC	7 7/8
AN381R	ADULT	9 3/4

SCHNIDT Tonsil Clamp

Catalog Number	Ring Handle	Jaw	Length (in.)
MA172R	OPEN RING	STR	7 1/2
BH961R	OPEN-RING	SLIGHT-CVD	7 1/4
BH963R	OPEN-RING	CVD	7 1/4
BH957R	CLOSED-RING	SLIGHT-CVD	7 1/4
BH959R	CLOSED-RING	CVD	7 1/4

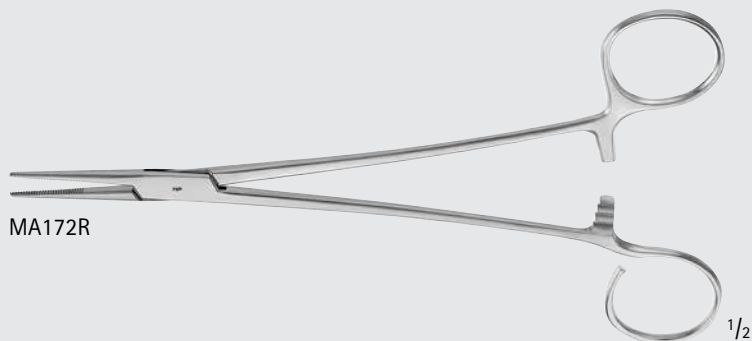

1/2



1/1

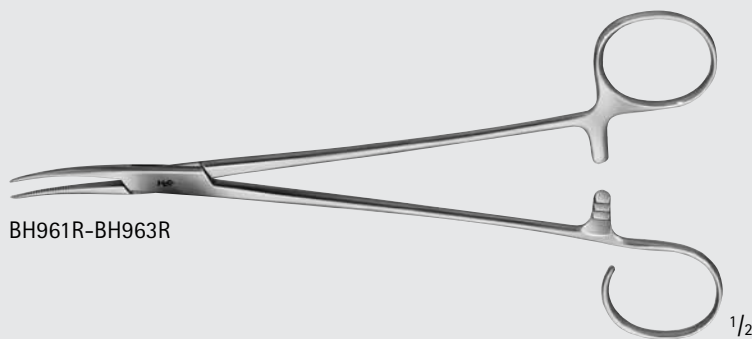

1/2



1/1



1/1

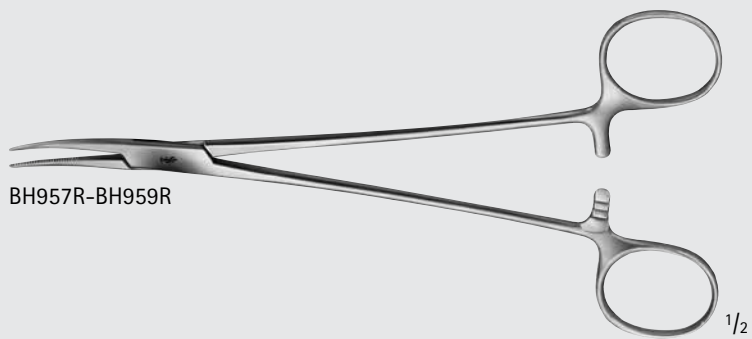

1/2



1/1



1/1

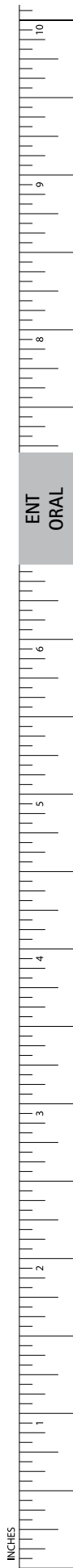

INCHES

ENT-ORAL

Clamps

Tonsil Clamp, X-long

Catalog Number	Jaw	Length (in.)
MB103R	CVD	14 1/2

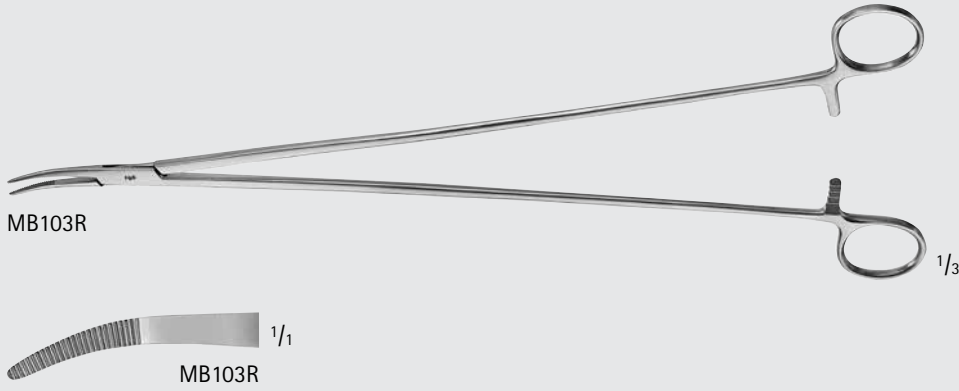

ADSON Tonsil Clamp, Delicate

Catalog Number	Jaw	Length (in.)
BH200R	STR	7 1/4
BH201R	CVD	7 1/4

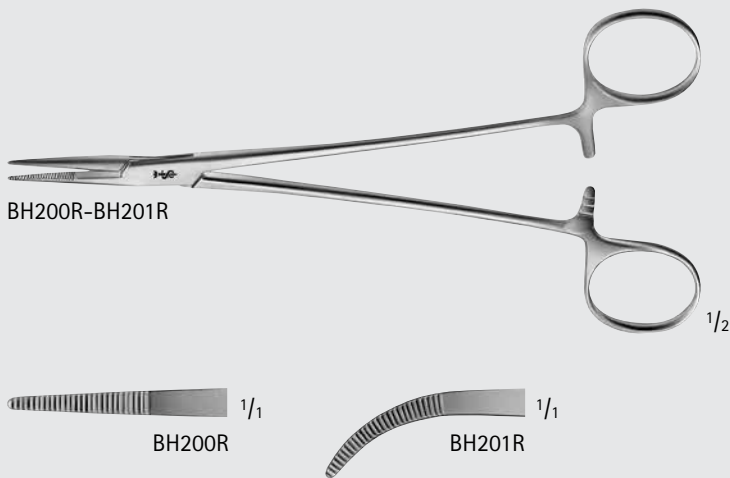

NISSEN Tonsil Clamp, Delicate

Catalog Number	Jaw	Length (in.)
BH199R	CVD	7 1/4

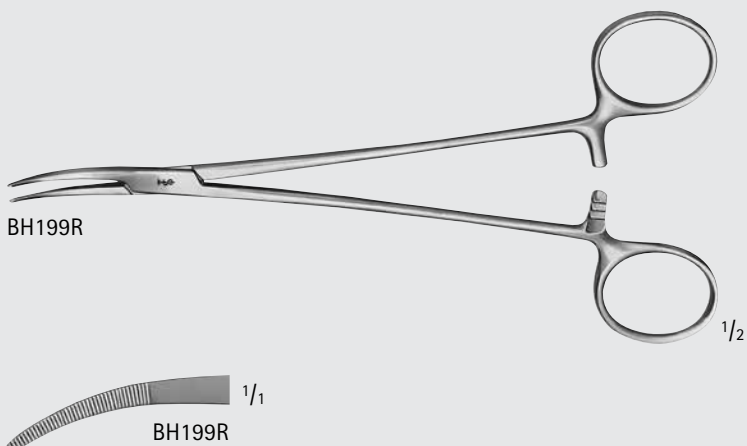

ENT
ORAL

MILLIMETERS

NEGUS Tonsil Clamp

Catalog Number	Jaw	Length (in.)
BH951R	HEAVY-CVD	7 1/2
BH952R	U-CVD	7 1/2

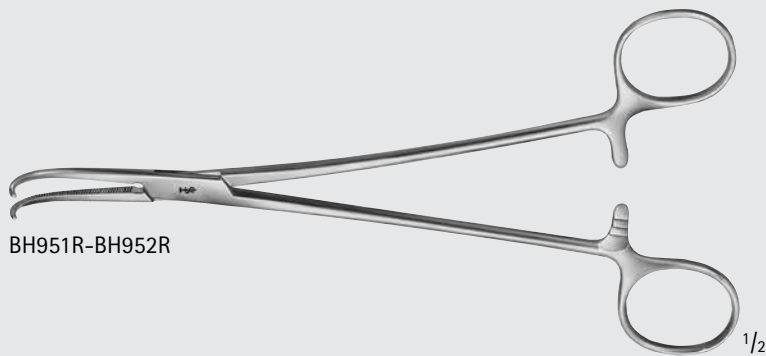

BH951R-BH952R

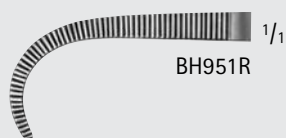

BH951R

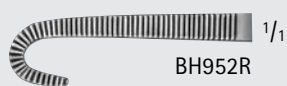

BH952R

MCHENRY Tonsil Artery and Sponge Holding Clamp

Catalog Number	Jaw	Length (in.)
MB533R	CVD	8

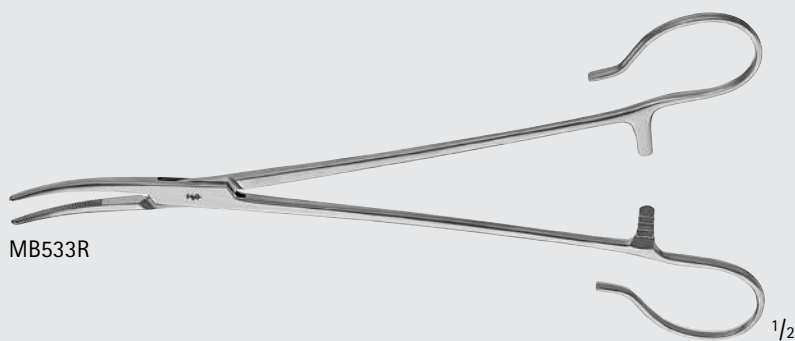

MB533R

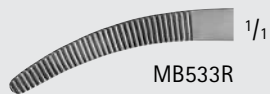

MB533R

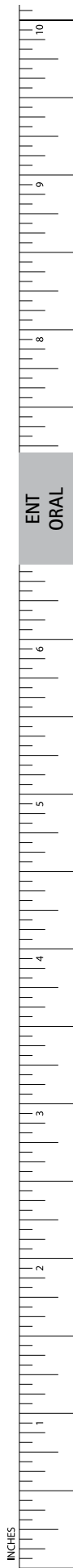

ENT-ORAL

Clamps

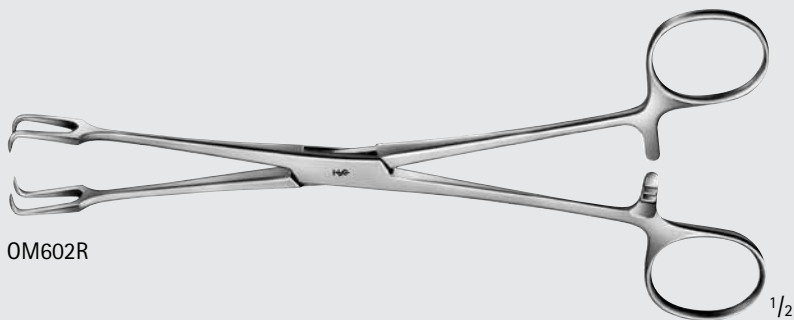

OM602R

1/2

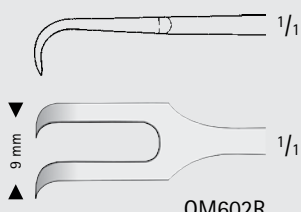

OM602R

MUSEUX Tonsil Clamp

Catalog Number	Tip	Length (in.)
OM602R	2 x 2	7 7/8



OM612R

1/2



OM612R

WHITE Tonsil Seizing Clamp

Catalog Number	Length (in.)
OM612R	7
OM613R	9 1/4

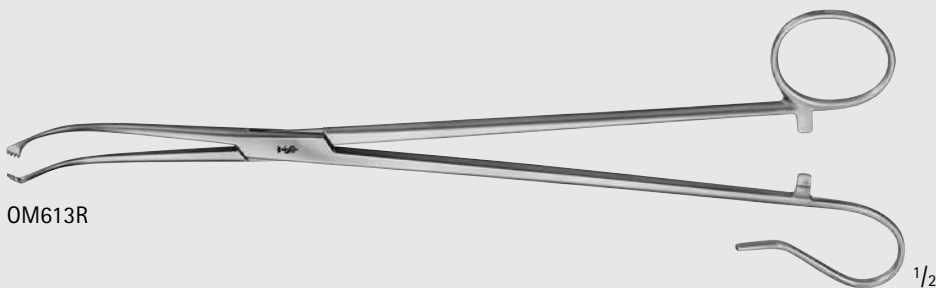

OM613R

1/2



OM613R

ENT
ORAL

ALLIS-COAKLEY Tonsil Clamp

Catalog Number	Jaw	Length (in.)
MA539R	STR	7 7/8
MA540R	STRONG CVD	7 5/8

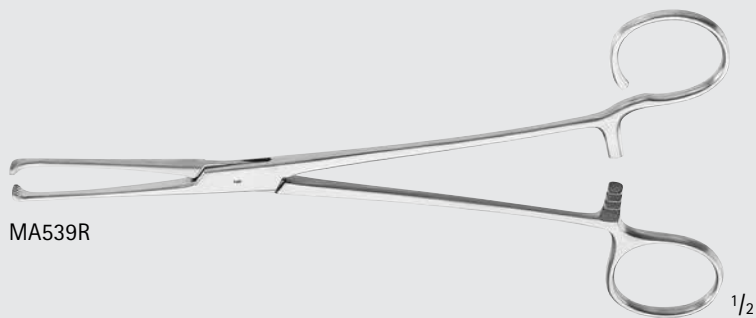

COLVER Tonsil Seizing Clamp

Catalog Number	Length (in.)
OM611R	7 7/8

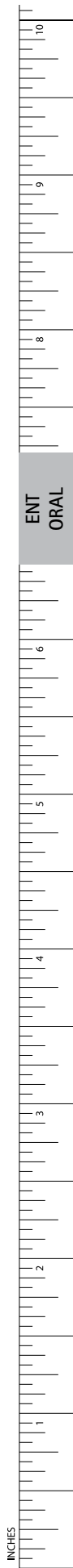

ENT-ORAL

Clamps

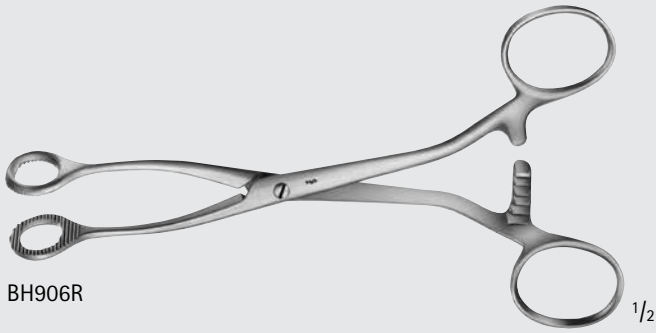

COLLIN Tongue Clamp

Catalog Number	Jaw	Length (in.)
BH906R	OVAL	6 1/4

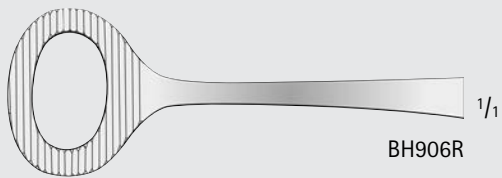

ENT
ORAL

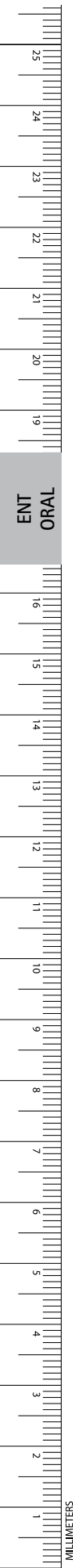

HEYWOOD-SMITH Tongue Clamp

Catalog Number	Tip	Length (in.)
AN710R	SERR	7 7/8
AN711R	SERR	8 1/4

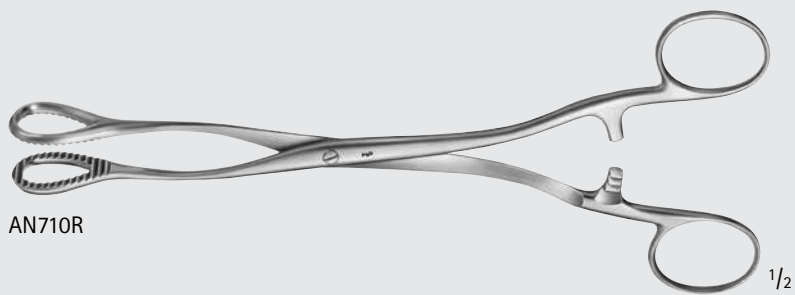

AN710R

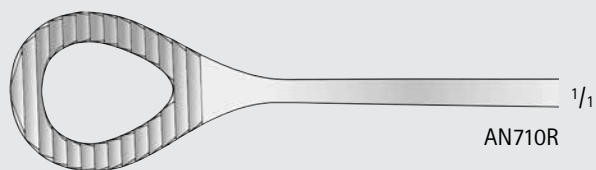

AN710R

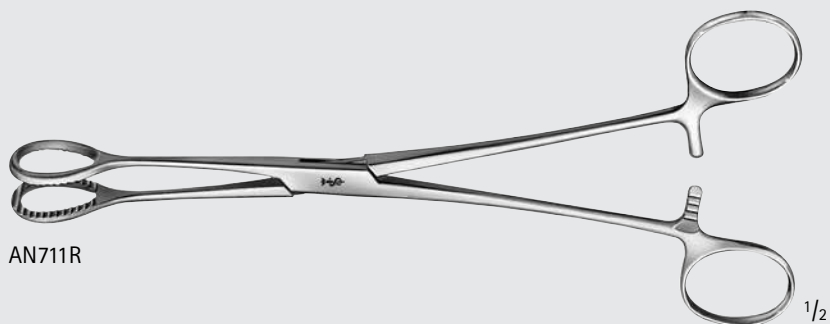

AN711R

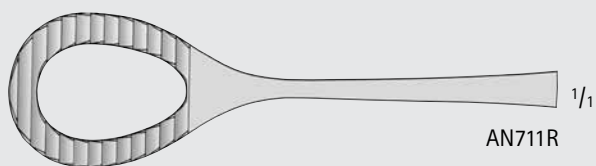

AN711R

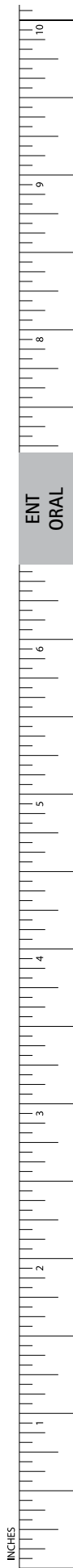

INCHES

ENT
ORAL

ENT-ORAL

Tracheal Dilators/Hooks/Retractors



FA025R

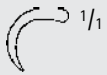

FA026R

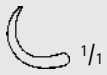

BOSE Tracheal Hook

Catalog Number	Tip	Length (in.)
FA025R	CVD-LEFT	6 1/2
FA026R	CVD-RIGHT	6 1/2



BT103R-BT107R



BT103R



BT106R



BT107R

Tracheal Retractor

Catalog Number	Tip	Blade End	Length (in.)
BT103R	SHARP	1 PRONG	7
BT106R	BLUNT	1 PRONG	7
BT107R	BLUNT	2 PRONGS	7



MB230



MB230

JACKSON Tracheal Retractor

Catalog Number	Length (in.)
MB230	7

ENT
ORAL



FA005R

TROUSSEAU Tracheal Dilator

Catalog Number	Length (in.)
FA005R	4 3/4

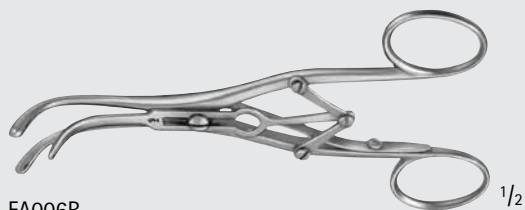

FA006R

LABORDE Tracheal Dilator

Catalog Number	Length (in.)
FA006R	5
FA007R	5 1/4

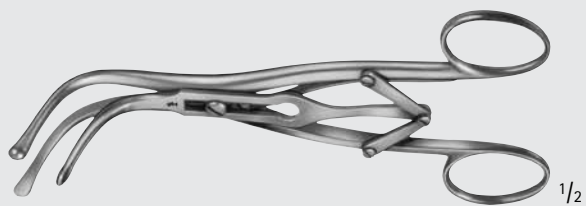

FA007R

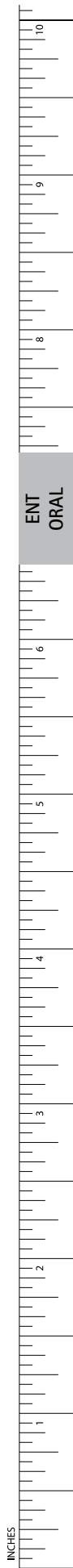

INCHES

ENT-ORAL

Retractors

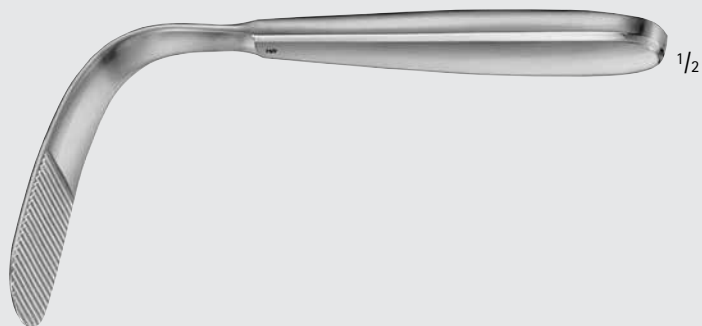

OM235R

TOBOLD Tongue Depressor

Catalog Number	Length (in.)
OM235R	6 1/4



OM236R-OM237R

WEDER Tongue Depressor

Catalog Number	Size	Length (in.)
OM236R	SMALL	5
OM237R	LARGE	5

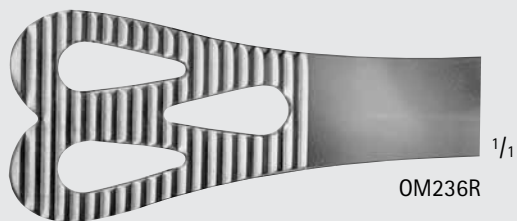

OM236R

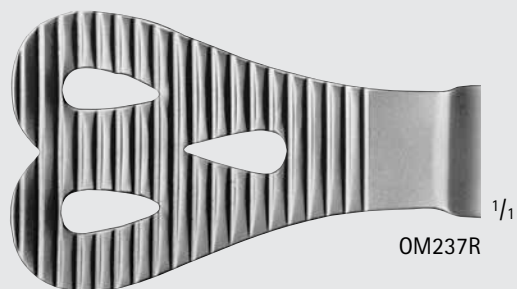

OM237R

ENT
ORAL

MILLIMETERS

ENT-ORAL

Retractors

LOTHROP Uvula Retractor

Catalog Number	Blade Size (mm)	Length (in.)
MA719R	17 x 20	9 5/8

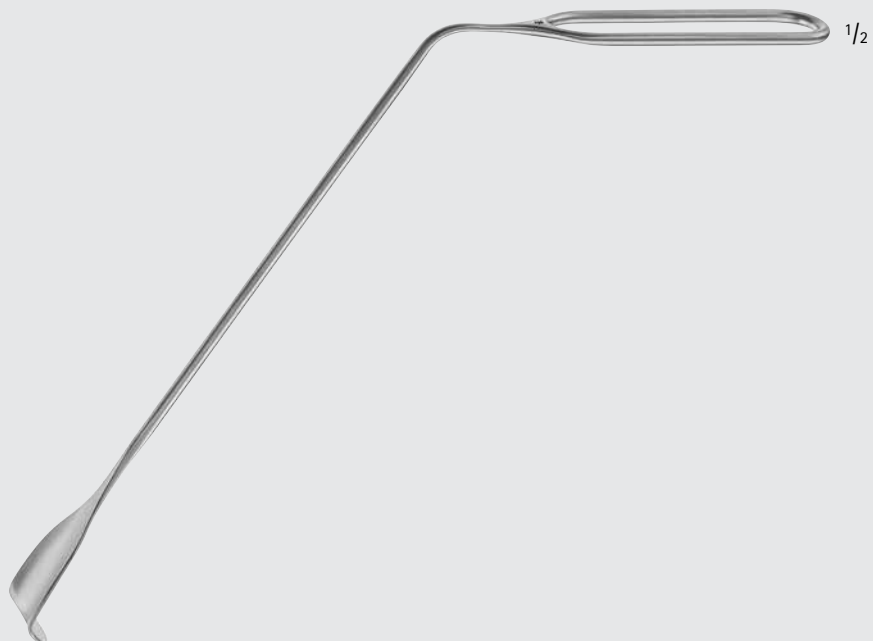

MA719R



MA719R

GOODYEAR Uvula Retractor

Catalog Number	Blade Size (mm)	Length (in.)
MA608R	15	7 3/8



MA608R

LAHEY Goiter Retractor

Catalog Number	Blade Size (mm)	Length (in.)
MB785R	24 x 8	7 7/8



MB785R



MB785R

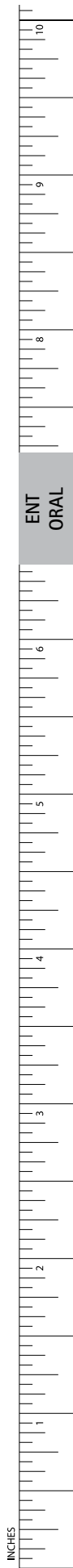

INCHES

ENT-ORAL

Retractors



MA434R-MA437R

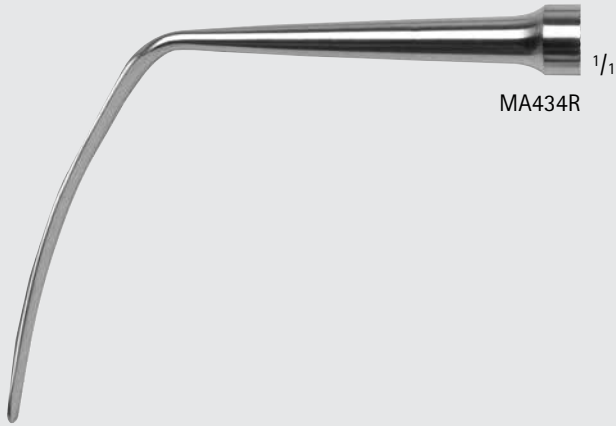

MA434R



MA436R

SEWALL Orbital Retractor

Catalog Number	Blade Size (mm)	Length (in.)
MA434R	7 x 52	6 3/4
MA435R	9 x 44	6 3/8
MA436R	11 x 50	6 3/8
MA437R	13 x 67	6 3/4



MA435R

ENT
ORAL

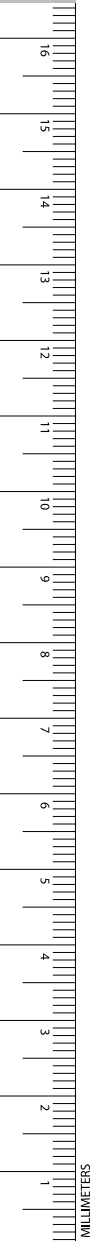

ENT-ORAL

Tonsil Dissectors

HURD Tonsil Dissector / Pillar Retractor

Catalog Number	Tip Size (mm)	Length (in.)
OM660R	6	8 1/2
OM661R	10	8 1/2

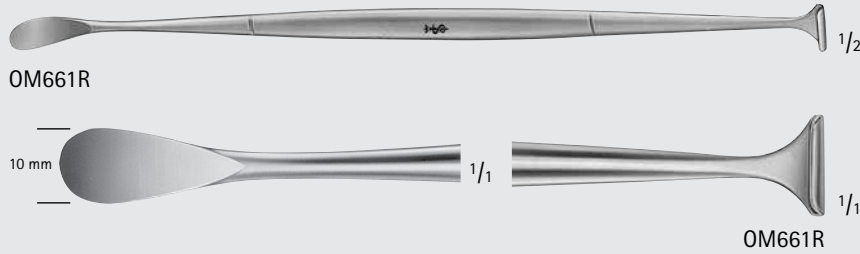
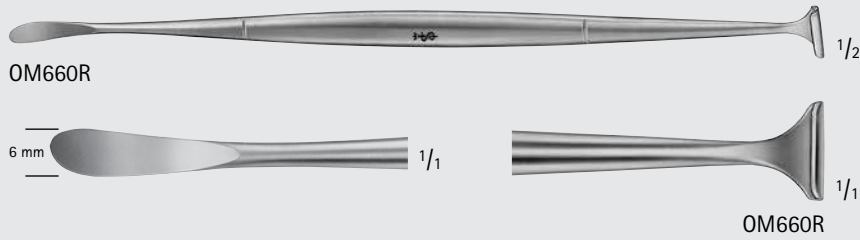

HENKE Tonsil Dissector

Catalog Number	Tip Size (mm)	Length (in.)
OM668R	12	9 1/4

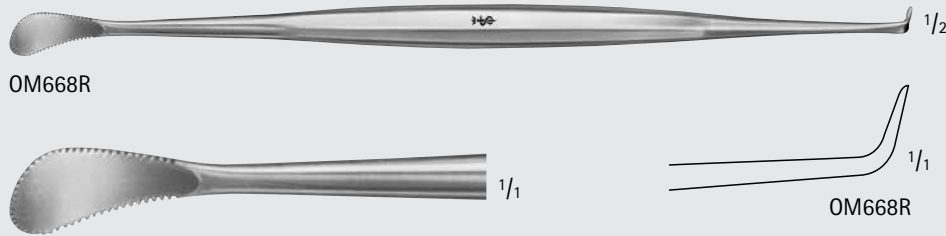

LOTHROP Tonsil Knife and Dissector

Catalog Number	Length (in.)
MA289R	8 1/4

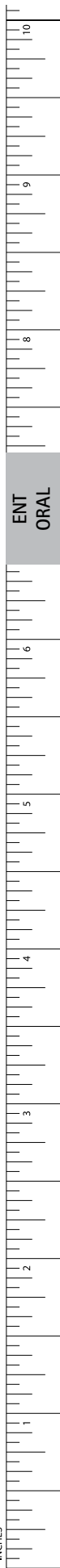

INCHES

ENT-ORAL

Adenotomes/Tonsil Snares/Wires



OM391R-OM398R

LA FORCE Adenotome

Catalog Number	Size (#)	Description	Length (in.)
OM391R	1	-	9 1/4
OM392R	2	-	9 1/4
OM393R	3	-	9 1/4
OM396R	-	SPARE BLADE F/ OM391R	-
OM397R	-	SPARE BLADE F/ OM392R	-
OM398R	-	SPARE BLADE F/ OM393R	-



OM396R



1/1

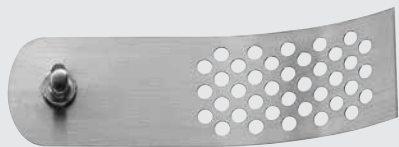

OM397R



1/1

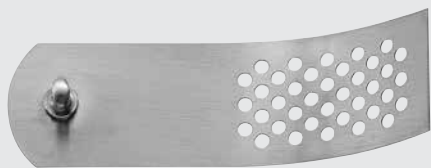

OM398R



1/1

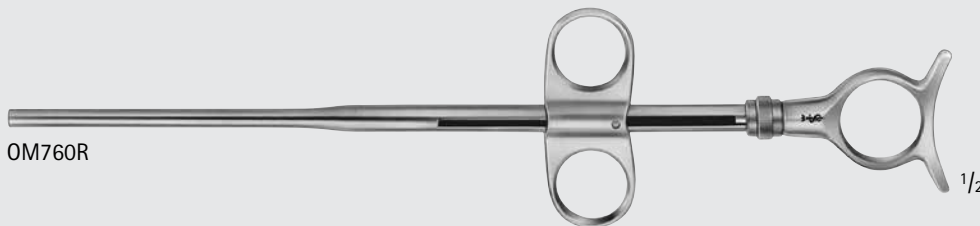

OM760R

EVES Tonsil Snare W/ 25 Gauge Wire

Catalog Number	Description	Length (in.)
OM760R	W/O RATCHET	9 3/4
OM761R	W/ RATCHET	9 3/4



OM761R

ENT ORAL

MILLIMETERS

LEWIS Tonsil Snare

Catalog Number	Description	Length (in.)
MA714R	INCLUDES 12 #8 SNARE WIRES	10 1/4

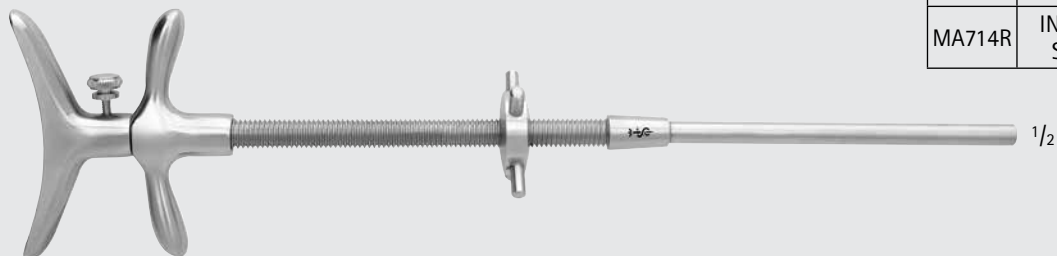

MA714R

SAGE Tonsil Snare

Catalog Number	Description	Length (in.)
MA493R	W/ SNARE WIRES	11
MA490R	12 #6 SNARE WIRES	4

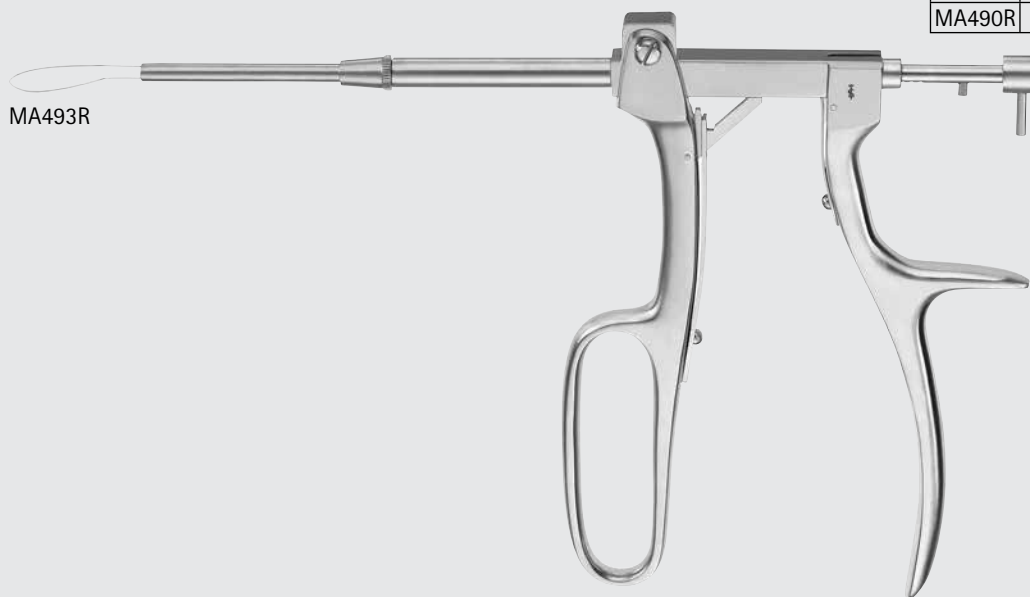

MA493R

1/2



MA490R

1/4

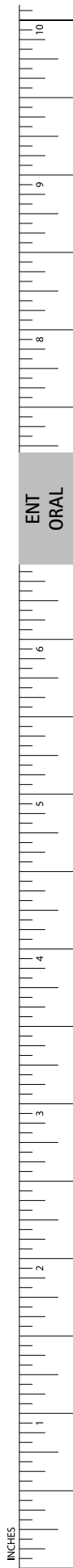

ENT ORAL

ENT-ORAL

Tonsil Snares/Wires/Adenotomes

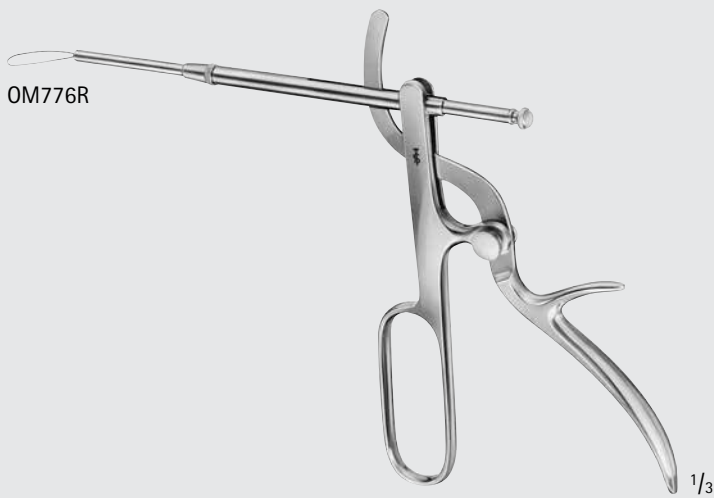

TYDING Tonsil Snare

Catalog Number	Description
OM781R	-
OM776R	TIP ONLY, STR

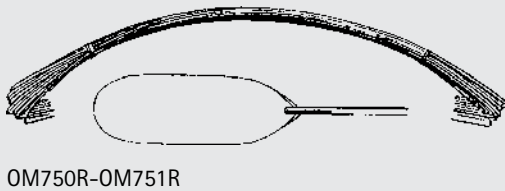

Tonsil Snare Wire

Catalog Number	Diameter (mm)	Size (#)	Sales Unit	Length (mm)
MA490R	1.4	6	12/BOX	100
OM750R	0.3	7	12/BOX	100
OM751R	0.5	8	12/BOX	100



ENT
ORAL

MILLIMETERS

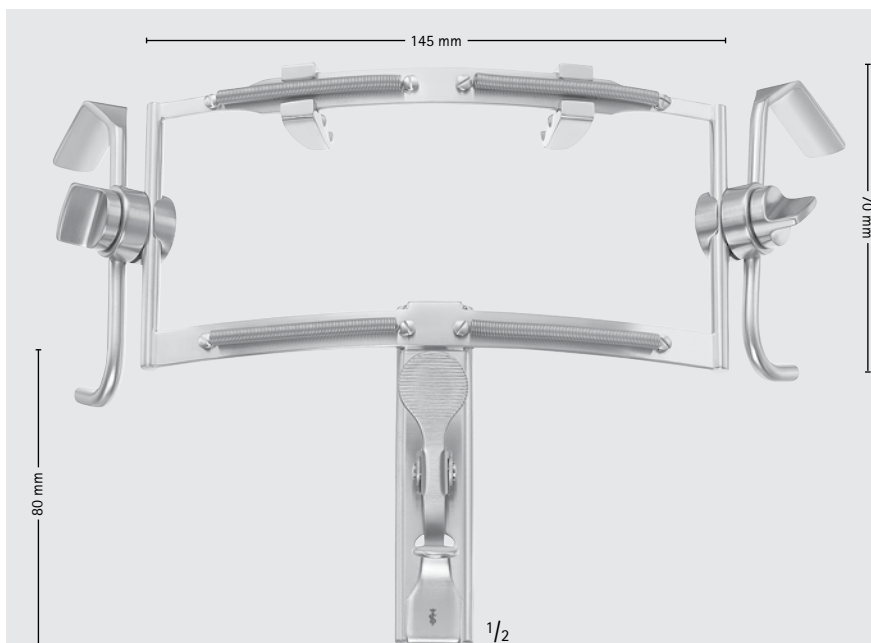

DINGMAN Mouth Gag

Catalog Number	Description
MA299R	COMPLETE SET WITH 3 BLADES AND FRAME

MA299R Includes:
 1 Mouth Gag OM105R,
 1 Blade of each OM171R, OM172R, OM177R

MA299R



MOLT Mouth Gag, Pediatric

Catalog Number	Description	Length (in.)	Length (m)
OM038R	-	4	-
TA009706	SPARE SILICONE TUBE ONLY, LATEX-FREE	-	1

TA009706 Protective covers for OM038R and OM040R available as silicone tubing which may be cut to length

OM038R



DOYEN-COLLIN Mouth Gag

Catalog Number	Description	Length (in.)	Length (m)
OM040R	-	4 3/4	-
TA009706	SPARE SILICONE TUBE ONLY, LATEX-FREE	-	1

TA009706 Protective covers for OM038R and OM040R available as silicone tubing which may be cut to length

OM040R, TA009706

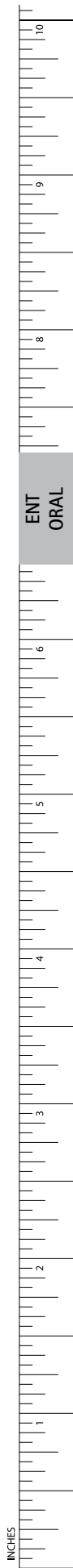

ENT-ORAL

Mouth Gags



OM041R, TA005771

DOYEN-JANSEN Mouth Gag

Catalog Number	Description	Length (in.)	Length (m)
OM041R	-	5 1/2	-
TA005771	SPARE SILICONE TUBE ONLY, LATEX-FREE	-	1

TA005771 Protective covers for OM041R available as silicone tubing which may be cut to length



OM047R

DENHARDT Mouth Gag

Catalog Number	Length (in.)
OM047R	5



OM070R-OM073R

WHITEHEAD-JENNINGS Mouth Gag

Catalog Number	Length (in.)
OM070R	3 1/2
OM071R	4 1/4
OM072R	5 1/8
OM073R	6



OP299

Teeth Protector, Latex-Free Rubber

Catalog Number	Size
OP299	ADOLESCENT AND ADULT

DAVIS Mouth Gag

Catalog Number	Blade Size (mm)	Size (#)	Description	Length (in.)
MA302R	-	-	COMPLETE SET, RIGHT	-
MA303R	-	-	COMPLETE SET, LEFT	-
MA307R	-	-	RIGHT FRAME ONLY	6
MA304R	20 x 34	1	BLADE	5 1/4
MA305R	23 x 64	2	BLADE	5 1/4
MA306R	25 x 79	3	BLADE	5 1/4
MA308R	25 x 85	3 1/2	BLADE	5 1/8
MA309R	25 x 95	4	BLADE	5 1/8
MA310R	25 x 106	5	BLADE	5 1/8
OM170	SILICONE INSERT			

MA302R Includes:

1 Blades w/ Tube of each MA304R, MA307R, OM112R, MA315R, OM114R, OM115R

MA303R Includes:

1 Blades w/ Tube of each OM116R, MA304R, OM112R, MA315R, OM114R, OM115R



MA307R



MA304R



MA305R



MA306R



MA308R



MA309R



MA310R

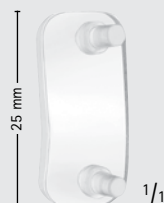

OM170

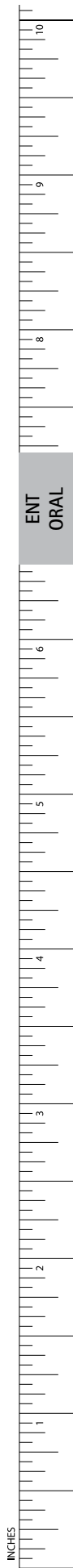

ENT-ORAL

Mouth Gags



MA315R



MA319R

DAVIS Mouth Gag W/ Tube

Catalog Number	Blade Size (mm)	Size (#)
MA315R	24 x 80	3
MA319R	25 x 90	3

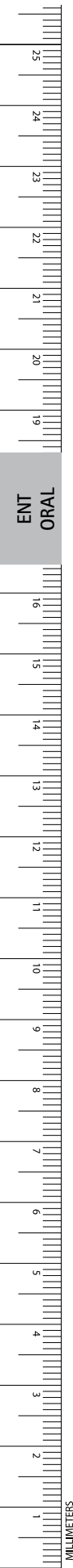

DAVIS-BOYLE Mouth Gag

Catalog Number	Blade Size (mm)	Size	Description	Length (in.)
OM118R	-	CHILD	FRAME ONLY	5 1/4
OM119R	-	TEEN	FRAME ONLY	5 3/4
OM116R	-	ADULT	FRAME ONLY	6 3/4
OM112R	25 x 62	-	BLADE	-
OM113R	25 x 75	-	BLADE	-
OM114R	25 x 92	-	BLADE	-
OM115R	25 x 108	-	BLADE	-
OM170	SILICONE INSERT			



OM118R



OM119R



OM116R



OM112R-OM115R

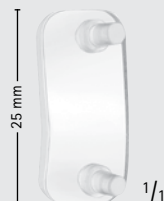

OM170

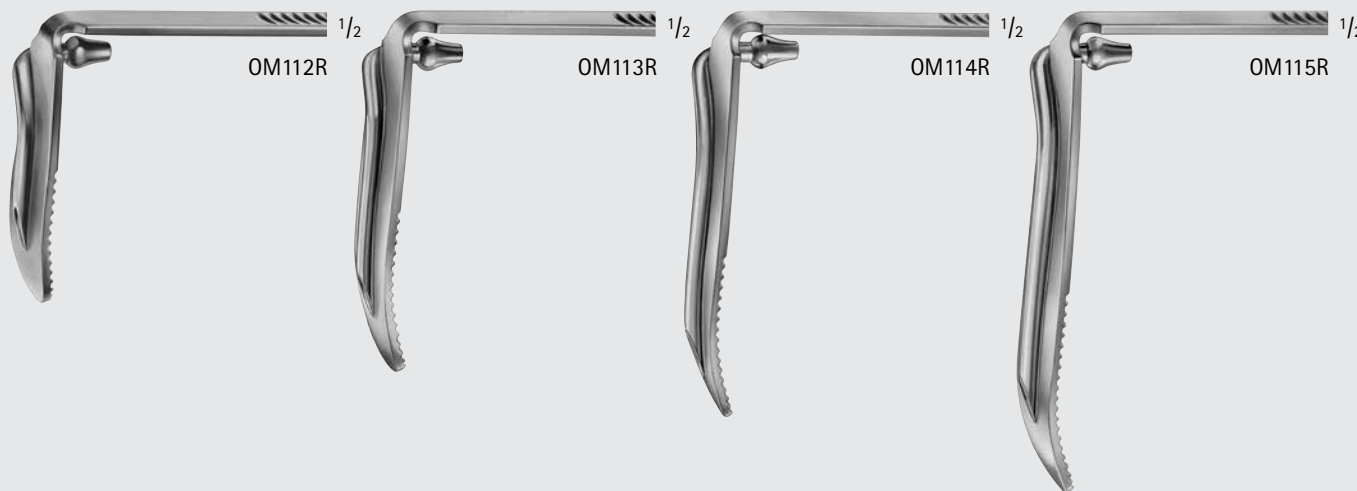

OM112R

OM113R

OM114R

OM115R

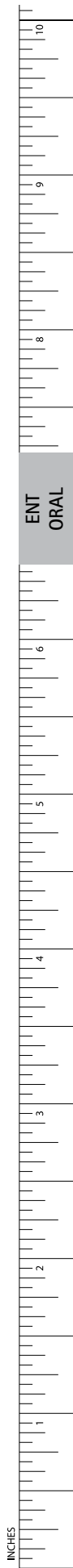

INCHES

ENT ORAL

ENT-ORAL

Mouth Gags

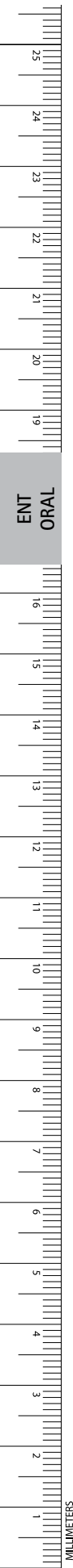

OM169R



OM170



OM179R

DAVIS-MEYER Tongue Depressor Frame

Catalog Number	Description
OM169R	FRAME, COMPLETE
OM170	SILICONE INSERT
OM179R	PALATE BLADE

